

# INDUSTRIAL DEVICES

CATALOGUE  
OF INDUSTRIAL CONTACTORS,  
MOTOR PROTECTIVE CIRCUIT BREAKERS,  
THERMAL RELAYS  
AND PANEL MOUNTED DEVICES



VALID FROM 1<sup>ST</sup> APRIL 2022



[www.noark-electric.eu](http://www.noark-electric.eu)

# NOARK



# Content

## Ordering Information

### Contactors and Relays

Ex9CS Miniature contactor .....	5
Ex9CSR Miniature reversible contactor .....	13
Ex9C Contactors up to 100 A .....	21
Ex9CR Reversible contactors .....	33
Ex9C Contactors up to 500 A .....	47
Ex9CC Capacitor contactors .....	55
Ex9JP Monitoring relays.....	65
Ex9JM Plug-in relays .....	71

### Motor Protective Circuit Breakers

Ex9S32A Motor protective circuit breakers .....	77
Ex9SN25B Motor protective circuit breakers .....	81

### Overload Thermal Relays

Ex9R Overload thermal relays up to 100 A .....	87
Ex9R Overload thermal relays up to 500 A .....	93

### Accessories for Industrial Devices

Accessories for contactors .....	99
Accessories for motor protective circuit breakers ..	109
Accessories for overload thermal relays .....	117

### Panel Mounted Devices

Ex9P1 Panel mounted control devices .....	123
Ex9P2FH Panel mounted control devices.....	136
Ex9IL Panel mounted signal lamps .....	137
Ex9PB Panel mounted buzzers .....	141

<b>Technical data</b> .....	146
-----------------------------	-----

<b>Index</b> .....	248
--------------------	-----

<b>Catalogues and assortment overview</b> .....	250
---	-----

# Content

## Technical Data

### Contactors and Relays

Ex9CS Miniature contactor .....	147
Ex9CSR Miniature reversible contactor .....	150
Ex9C Contactors up to 100 A .....	154
Ex9CR Reversible contactors .....	166
Ex9C Contactors up to 500 A .....	182
Ex9CC Capacitor contactors .....	194
Ex9JP Monitoring relays.....	197
Ex9JM Plug-in relays .....	200

### Motor Protective Circuit Breakers

Ex9S32A Motor protective circuit breakers .....	202
Ex9SN25B Motor protective circuit breakers .....	206

### Overload Thermal Relays

Ex9R Overload thermal relays up to 100 A .....	210
Ex9R Overload thermal relays up to 500 A .....	213

### Accessories for Industrial Devices

Accessories for contactors .....	216
Accessories for motor protective circuit breakers ..	227
Accessories for overload thermal relays .....	232

### Panel Mounted Devices

Ex9P1 Panel mounted control devices .....	238
Ex9P2FH Panel mounted control devices.....	242
Ex9IL Panel mounted signal lamps .....	244
Ex9PB Panel mounted buzzers .....	246

# Contactors and Relays

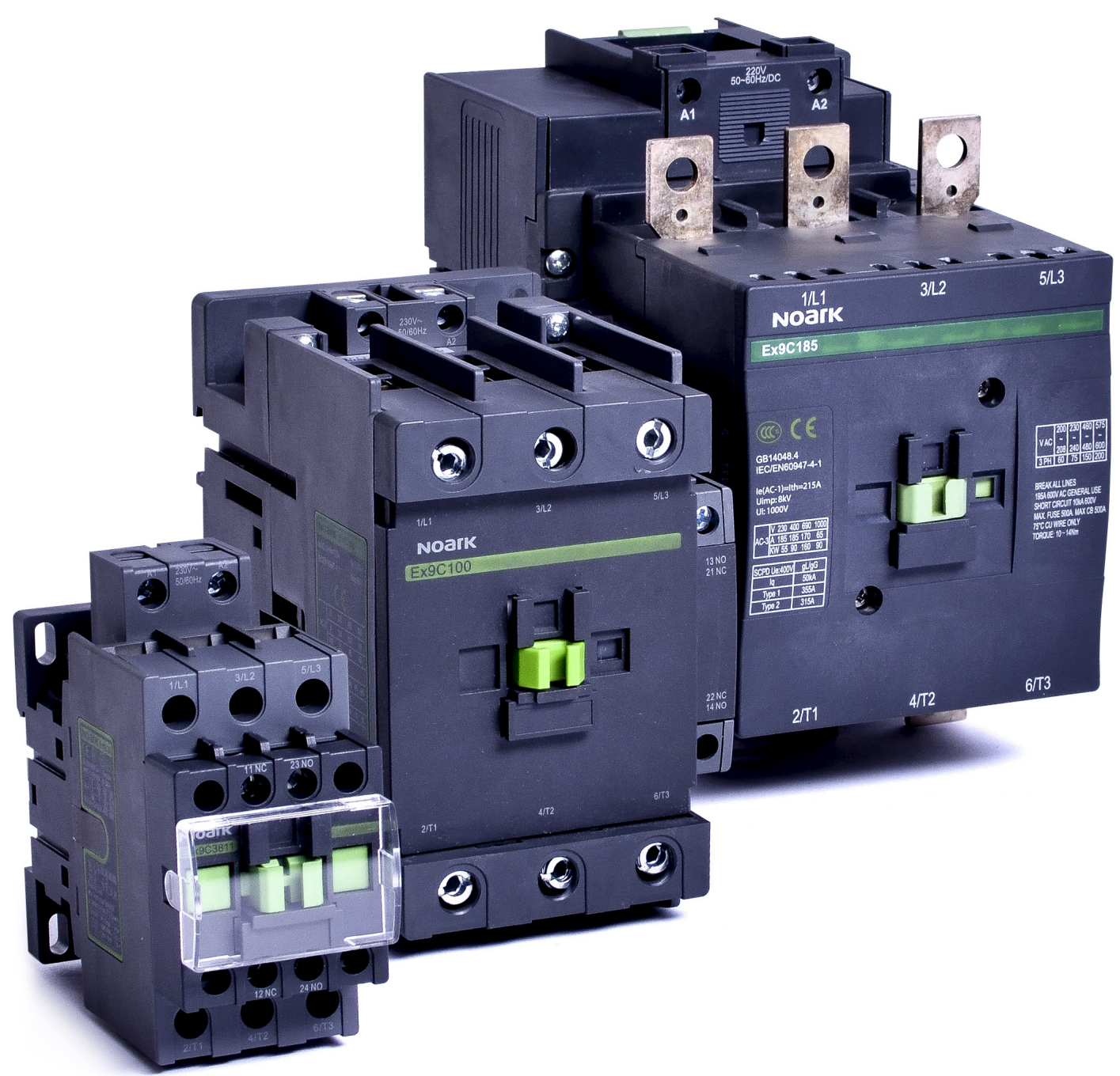

# Contactors and Relays

## Professional Tips

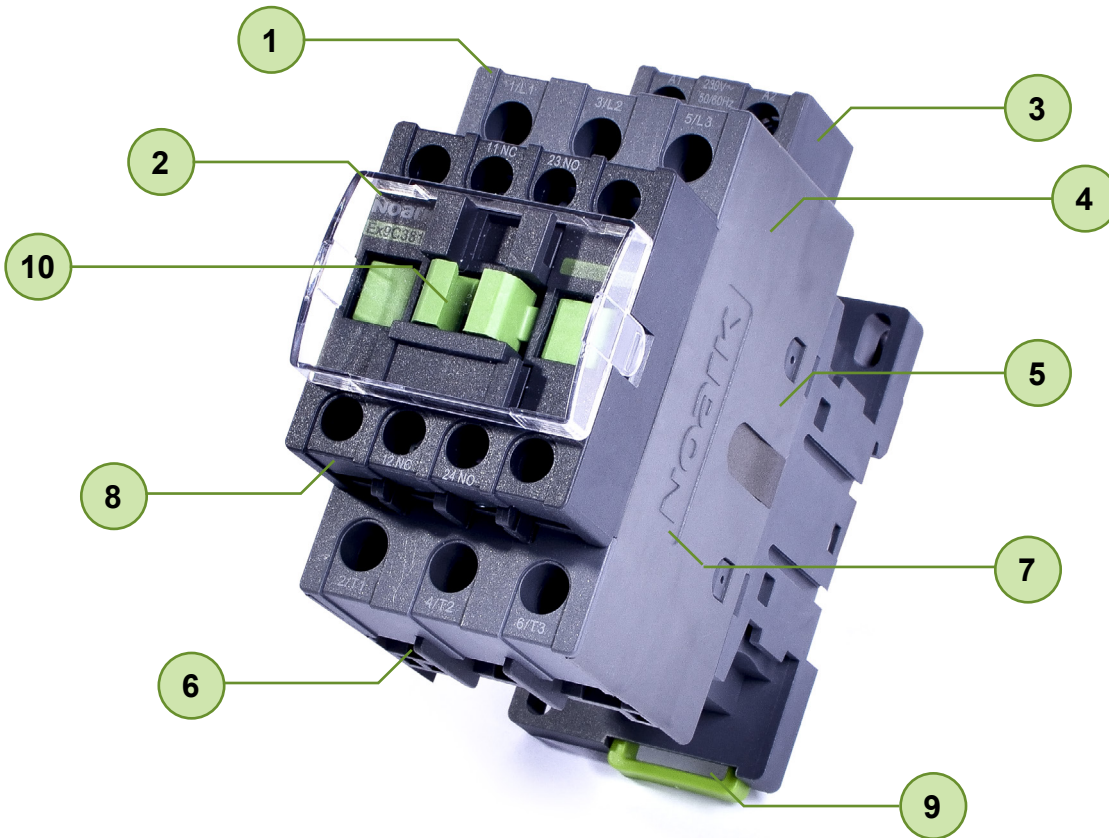

- |   |                                       |    |   |
|---|---------------------------------------|----|---|
| 1 | 5 year warranty                       | 6  | Low power consumption                   |
| 2 | Miniature to large sizes              | 7  | Special contactors for capacitance load |
| 3 | Various operational voltage from 24 V | 8  | Different combination of contacts       |
| 4 | AC and DC variants available          | 9  | Mounting on DIN rail or panel           |
| 5 | Rated current up to 500 A             | 10 | Wide range of accessories               |

# Miniature contactors Ex9CS



- Tested according to IEC / EN 60947-4-1
- 3 and 4-pole versions
- Rated current AC-3 6, 9 and 12 A at 400 V
- Coil control voltage 24 — 415 V AC
- Rated conditional short circuit current  $I_q = 50 \text{ kA}$
- Suitable for industrial as well as domestic applications
- Mounting onto device rail (DIN) 35 mm or onto panel

Ex9CS contactors bring excellent electric parameters in the form of very compact device. These contactors can be used for both industrial as well as domestic applications. Thermal current and AC-1 load 20 A at 690 V AC allows switching of resistive loads with maximum currents usual for domestic applications. Thanks to compact dimensions, Ex9CS contactors are ideal solution for space limited installations.

Contactors are offered as 3 and 4-pole versions and as a 4-pole version with main contacts configuration 2 normally open and 2 normally closed (4P/22).

## Type Key

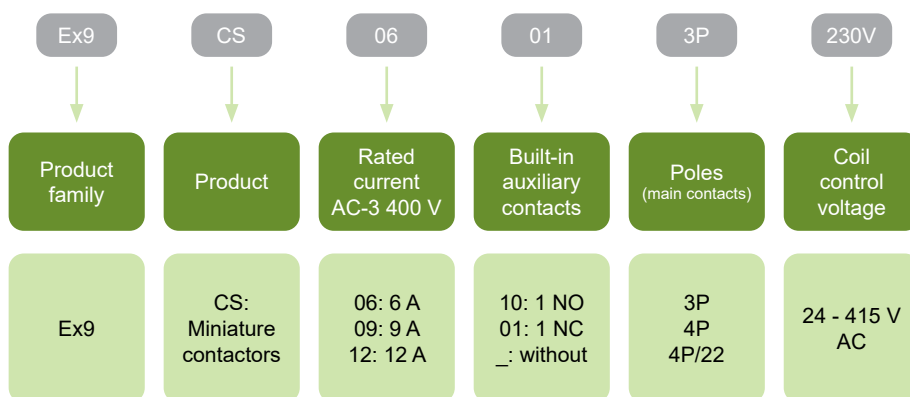

## Certification marks



# Miniature contactors Ex9CS

## Accessories

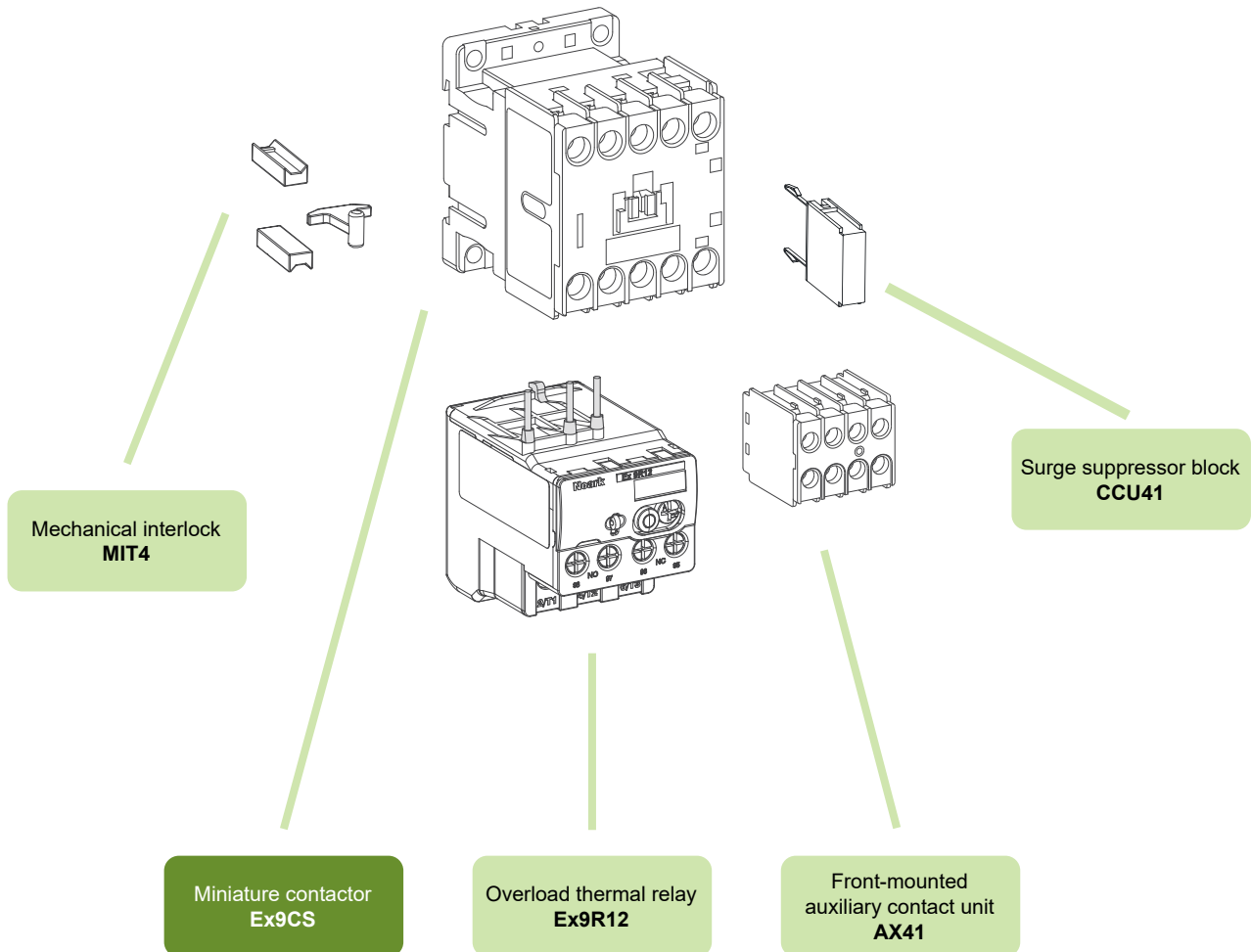

Auxiliary contacts AX41

Overload thermal relays Ex9R12

Surge suppressor block CCU41

Mechanical interlock MIT4

see page 103

see page 89

see page 106

see page 105



# Miniature contactors Ex9CS

## Rated current 6 A, 3-pole

- Miniature version of contactor
- Mounting onto device (DIN) rail 35 mm or onto panel
- Front-mounted auxiliary contacts AX41.. can be used
- Can be combined with overload relays Ex9R12



Control voltage	AC-3 $I_e$	Frame size	Poles	Auxiliary contacts	Article No.	Type	Packing
415 V AC	6 A	S12	3	1 NC	100956	Ex9CS06 01 3P 415V	1/72
400 V AC	6 A	S12	3	1 NC	100957	Ex9CS06 01 3P 400V	1/72
380 V AC	6 A	S12	3	1 NC	100958	Ex9CS06 01 3P 380V	1/72
240 V AC	6 A	S12	3	1 NC	100959	Ex9CS06 01 3P 240V	1/72
<b>230 V AC</b>	<b>6 A</b>	<b>S12</b>	<b>3</b>	<b>1 NC</b>	<b>100960</b>	<b>Ex9CS06 01 3P 230V</b>	<b>1/72</b>
220 V AC	6 A	S12	3	1 NC	100961	Ex9CS06 01 3P 220V	1/72
127 V AC	6 A	S12	3	1 NC	100962	Ex9CS06 01 3P 127V	1/72
110 V AC	6 A	S12	3	1 NC	100963	Ex9CS06 01 3P 110V	1/72
48 V AC	6 A	S12	3	1 NC	100964	Ex9CS06 01 3P 48V	1/72
42 V AC	6 A	S12	3	1 NC	100965	Ex9CS06 01 3P 42V	1/72
36 V AC	6 A	S12	3	1 NC	100966	Ex9CS06 01 3P 36V	1/72
<b>24 V AC</b>	<b>6 A</b>	<b>S12</b>	<b>3</b>	<b>1 NC</b>	<b>100967</b>	<b>Ex9CS06 01 3P 24V</b>	<b>1/72</b>
415 V AC	6 A	S12	3	1 NO	100968	Ex9CS06 10 3P 415V	1/72
400 V AC	6 A	S12	3	1 NO	100969	Ex9CS06 10 3P 400V	1/72
380 V AC	6 A	S12	3	1 NO	100970	Ex9CS06 10 3P 380V	1/72
240 V AC	6 A	S12	3	1 NO	100971	Ex9CS06 10 3P 240V	1/72
<b>230 V AC</b>	<b>6 A</b>	<b>S12</b>	<b>3</b>	<b>1 NO</b>	<b>100972</b>	<b>Ex9CS06 10 3P 230V</b>	<b>1/72</b>
220 V AC	6 A	S12	3	1 NO	100973	Ex9CS06 10 3P 220V	1/72
127 V AC	6 A	S12	3	1 NO	100974	Ex9CS06 10 3P 127V	1/72
110 V AC	6 A	S12	3	1 NO	100975	Ex9CS06 10 3P 110V	1/72
48 V AC	6 A	S12	3	1 NO	100976	Ex9CS06 10 3P 48V	1/72
42 V AC	6 A	S12	3	1 NO	100977	Ex9CS06 10 3P 42V	1/72
36 V AC	6 A	S12	3	1 NO	100978	Ex9CS06 10 3P 36V	1/72
<b>24 V AC</b>	<b>6 A</b>	<b>S12</b>	<b>3</b>	<b>1 NO</b>	<b>100979</b>	<b>Ex9CS06 10 3P 24V</b>	<b>1/72</b>

### Wiring diagrams

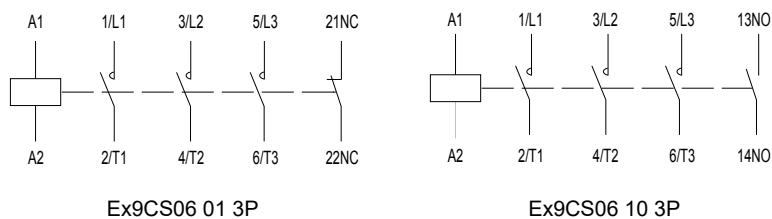

# Miniature contactors Ex9CS

## Rated current 6 A, 4-pole

- Miniature version of contactor
- Mounting onto device (DIN) rail 35 mm or onto panel
- Front-mounted auxiliary contacts AX41.. can be used



Control voltage	AC-3 $I_e$	Frame size	Poles	Auxiliary contacts	Article No.	Type	Packing
415 V AC	6 A	S12	4	-	100980	Ex9CS06 4P 415V	1/72
400 V AC	6 A	S12	4	-	100981	Ex9CS06 4P 400V	1/72
380 V AC	6 A	S12	4	-	100982	Ex9CS06 4P 380V	1/72
240 V AC	6 A	S12	4	-	100983	Ex9CS06 4P 240V	1/72
<b>230 V AC</b>	<b>6 A</b>	<b>S12</b>	<b>4</b>	-	<b>100984</b>	<b>Ex9CS06 4P 230V</b>	<b>1/72</b>
220 V AC	6 A	S12	4	-	100985	Ex9CS06 4P 220V	1/72
127 V AC	6 A	S12	4	-	100986	Ex9CS06 4P 127V	1/72
110 V AC	6 A	S12	4	-	100987	Ex9CS06 4P 110V	1/72
48 V AC	6 A	S12	4	-	100988	Ex9CS06 4P 48V	1/72
42 V AC	6 A	S12	4	-	100989	Ex9CS06 4P 42V	1/72
36 V AC	6 A	S12	4	-	100990	Ex9CS06 4P 36V	1/72
<b>24 V AC</b>	<b>6 A</b>	<b>S12</b>	<b>4</b>	-	<b>100991</b>	<b>Ex9CS06 4P 24V</b>	<b>1/72</b>
415 V AC	6 A	S12	2+2	-	100992	Ex9CS06 4P/22 415V	1/72
400 V AC	6 A	S12	2+2	-	100993	Ex9CS06 4P/22 400V	1/72
380 V AC	6 A	S12	2+2	-	100994	Ex9CS06 4P/22 380V	1/72
240 V AC	6 A	S12	2+2	-	100995	Ex9CS06 4P/22 240V	1/72
<b>230 V AC</b>	<b>6 A</b>	<b>S12</b>	<b>2+2</b>	-	<b>100996</b>	<b>Ex9CS06 4P/22 230V</b>	<b>1/72</b>
220 V AC	6 A	S12	2+2	-	100997	Ex9CS06 4P/22 220V	1/72
127 V AC	6 A	S12	2+2	-	100998	Ex9CS06 4P/22 127V	1/72
110 V AC	6 A	S12	2+2	-	100999	Ex9CS06 4P/22 110V	1/72
48 V AC	6 A	S12	2+2	-	101000	Ex9CS06 4P/22 48V	1/72
42 V AC	6 A	S12	2+2	-	101001	Ex9CS06 4P/22 42V	1/72
36 V AC	6 A	S12	2+2	-	101002	Ex9CS06 4P/22 36V	1/72
<b>24 V AC</b>	<b>6 A</b>	<b>S12</b>	<b>2+2</b>	-	<b>101003</b>	<b>Ex9CS06 4P/22 24V</b>	<b>1/72</b>

### Wiring diagrams

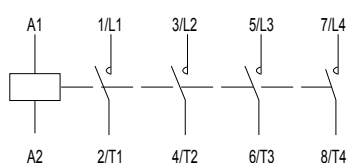

Ex9CS06 4P

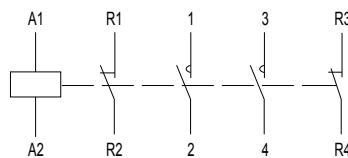

Ex9CS06 4P/22

# Miniature contactors Ex9CS

## Rated current 9 A, 3-pole

- Miniature version of contactor
- Mounting onto device (DIN) rail 35 mm or onto panel
- Front-mounted auxiliary contacts AX41.. can be used
- Can be combined with overload relays Ex9R12



Control voltage	AC-3 $I_e$	Frame size	Poles	Auxiliary contacts	Article No.	Type	Packing
415 V AC	9 A	S12	3	1 NC	101004	Ex9CS09 01 3P 415V	1/72
400 V AC	9 A	S12	3	1 NC	101005	Ex9CS09 01 3P 400V	1/72
380 V AC	9 A	S12	3	1 NC	101006	Ex9CS09 01 3P 380V	1/72
240 V AC	9 A	S12	3	1 NC	101007	Ex9CS09 01 3P 240V	1/72
<b>230 V AC</b>	<b>9 A</b>	<b>S12</b>	<b>3</b>	<b>1 NC</b>	<b>101008</b>	<b>Ex9CS09 01 3P 230V</b>	<b>1/72</b>
220 V AC	9 A	S12	3	1 NC	101009	Ex9CS09 01 3P 220V	1/72
127 V AC	9 A	S12	3	1 NC	101010	Ex9CS09 01 3P 127V	1/72
110 V AC	9 A	S12	3	1 NC	101011	Ex9CS09 01 3P 110V	1/72
48 V AC	9 A	S12	3	1 NC	101012	Ex9CS09 01 3P 48V	1/72
42 V AC	9 A	S12	3	1 NC	101013	Ex9CS09 01 3P 42V	1/72
36 V AC	9 A	S12	3	1 NC	101014	Ex9CS09 01 3P 36V	1/72
<b>24 V AC</b>	<b>9 A</b>	<b>S12</b>	<b>3</b>	<b>1 NC</b>	<b>101015</b>	<b>Ex9CS09 01 3P 24V</b>	<b>1/72</b>
415 V AC	9 A	S12	3	1 NO	101016	Ex9CS09 10 3P 415V	1/72
400 V AC	9 A	S12	3	1 NO	101017	Ex9CS09 10 3P 400V	1/72
380 V AC	9 A	S12	3	1 NO	101018	Ex9CS09 10 3P 380V	1/72
240 V AC	9 A	S12	3	1 NO	101019	Ex9CS09 10 3P 240V	1/72
<b>230 V AC</b>	<b>9 A</b>	<b>S12</b>	<b>3</b>	<b>1 NO</b>	<b>101020</b>	<b>Ex9CS09 10 3P 230V</b>	<b>1/72</b>
220 V AC	9 A	S12	3	1 NO	101021	Ex9CS09 10 3P 220V	1/72
127 V AC	9 A	S12	3	1 NO	101022	Ex9CS09 10 3P 127V	1/72
110 V AC	9 A	S12	3	1 NO	101023	Ex9CS09 10 3P 110V	1/72
48 V AC	9 A	S12	3	1 NO	101024	Ex9CS09 10 3P 48V	1/72
42 V AC	9 A	S12	3	1 NO	101025	Ex9CS09 10 3P 42V	1/72
36 V AC	9 A	S12	3	1 NO	101026	Ex9CS09 10 3P 36V	1/72
<b>24 V AC</b>	<b>9 A</b>	<b>S12</b>	<b>3</b>	<b>1 NO</b>	<b>101027</b>	<b>Ex9CS09 10 3P 24V</b>	<b>1/72</b>

### Wiring diagrams

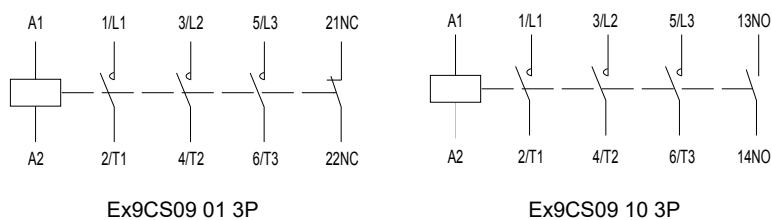

# Miniature contactors Ex9CS

## Rated current 9 A, 4-pole

- Miniature version of contactor
- Mounting onto device (DIN) rail 35 mm or onto panel
- Front-mounted auxiliary contacts AX41.. can be used



Control voltage	AC-3 $I_e$	Frame size	Poles	Auxiliary contacts	Article No.	Type	Packing
415 V AC	9 A	S12	4	-	101028	Ex9CS09 4P 415V	1/72
400 V AC	9 A	S12	4	-	101029	Ex9CS09 4P 400V	1/72
380 V AC	9 A	S12	4	-	101030	Ex9CS09 4P 380V	1/72
240 V AC	9 A	S12	4	-	101031	Ex9CS09 4P 240V	1/72
<b>230 V AC</b>	<b>9 A</b>	<b>S12</b>	<b>4</b>	-	<b>101032</b>	<b>Ex9CS09 4P 230V</b>	<b>1/72</b>
220 V AC	9 A	S12	4	-	101033	Ex9CS09 4P 220V	1/72
127 V AC	9 A	S12	4	-	101034	Ex9CS09 4P 127V	1/72
110 V AC	9 A	S12	4	-	101035	Ex9CS09 4P 110V	1/72
48 V AC	9 A	S12	4	-	101036	Ex9CS09 4P 48V	1/72
42 V AC	9 A	S12	4	-	101037	Ex9CS09 4P 42V	1/72
36 V AC	9 A	S12	4	-	101038	Ex9CS09 4P 36V	1/72
<b>24 V AC</b>	<b>9 A</b>	<b>S12</b>	<b>4</b>	-	<b>101039</b>	<b>Ex9CS09 4P 24V</b>	<b>1/72</b>
<hr/>							
415 V AC	9 A	S12	2+2	-	101040	Ex9CS09 4P/22 415V	1/72
400 V AC	9 A	S12	2+2	-	101041	Ex9CS09 4P/22 400V	1/72
380 V AC	9 A	S12	2+2	-	101042	Ex9CS09 4P/22 380V	1/72
240 V AC	9 A	S12	2+2	-	101043	Ex9CS09 4P/22 240V	1/72
<b>230 V AC</b>	<b>9 A</b>	<b>S12</b>	<b>2+2</b>	-	<b>101044</b>	<b>Ex9CS09 4P/22 230V</b>	<b>1/72</b>
220 V AC	9 A	S12	2+2	-	101045	Ex9CS09 4P/22 220V	1/72
127 V AC	9 A	S12	2+2	-	101046	Ex9CS09 4P/22 127V	1/72
110 V AC	9 A	S12	2+2	-	101047	Ex9CS09 4P/22 110V	1/72
48 V AC	9 A	S12	2+2	-	101048	Ex9CS09 4P/22 48V	1/72
42 V AC	9 A	S12	2+2	-	101049	Ex9CS09 4P/22 42V	1/72
36 V AC	9 A	S12	2+2	-	101050	Ex9CS09 4P/22 36V	1/72
<b>24 V AC</b>	<b>9 A</b>	<b>S12</b>	<b>2+2</b>	-	<b>101051</b>	<b>Ex9CS09 4P/22 24V</b>	<b>1/72</b>

### Wiring diagrams

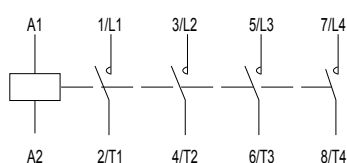

Ex9CS09 4P

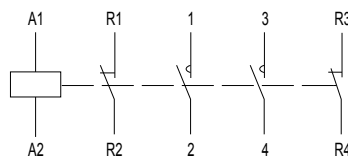

Ex9CS09 4P/22

# Miniature contactors Ex9CS

## Rated current 12 A, 3-pole

- Miniature version of contactor
- Mounting onto device (DIN) rail 35 mm or onto panel
- Front-mounted auxiliary contacts AX41.. can be used
- Can be combined with overload relays Ex9R12



Control voltage	AC-3 $I_e$	Frame size	Poles	Auxiliary contacts	Article No.	Type	Packing
415 V AC	12 A	S12	3	1 NC	101052	Ex9CS12 01 3P 415V	1/72
400 V AC	12 A	S12	3	1 NC	101053	Ex9CS12 01 3P 400V	1/72
380 V AC	12 A	S12	3	1 NC	101054	Ex9CS12 01 3P 380V	1/72
240 V AC	12 A	S12	3	1 NC	101055	Ex9CS12 01 3P 240V	1/72
<b>230 V AC</b>	<b>12 A</b>	<b>S12</b>	<b>3</b>	<b>1 NC</b>	<b>101056</b>	<b>Ex9CS12 01 3P 230V</b>	<b>1/72</b>
220 V AC	12 A	S12	3	1 NC	101057	Ex9CS12 01 3P 220V	1/72
127 V AC	12 A	S12	3	1 NC	101058	Ex9CS12 01 3P 127V	1/72
110 V AC	12 A	S12	3	1 NC	101059	Ex9CS12 01 3P 110V	1/72
48 V AC	12 A	S12	3	1 NC	101060	Ex9CS12 01 3P 48V	1/72
42 V AC	12 A	S12	3	1 NC	101061	Ex9CS12 01 3P 42V	1/72
36 V AC	12 A	S12	3	1 NC	101062	Ex9CS12 01 3P 36V	1/72
<b>24 V AC</b>	<b>12 A</b>	<b>S12</b>	<b>3</b>	<b>1 NC</b>	<b>101063</b>	<b>Ex9CS12 01 3P 24V</b>	<b>1/72</b>
<hr/>							
415 V AC	12 A	S12	3	1 NO	101064	Ex9CS12 10 3P 415V	1/72
400 V AC	12 A	S12	3	1 NO	101065	Ex9CS12 10 3P 400V	1/72
380 V AC	12 A	S12	3	1 NO	101066	Ex9CS12 10 3P 380V	1/72
240 V AC	12 A	S12	3	1 NO	101067	Ex9CS12 10 3P 240V	1/72
<b>230 V AC</b>	<b>12 A</b>	<b>S12</b>	<b>3</b>	<b>1 NO</b>	<b>101068</b>	<b>Ex9CS12 10 3P 230V</b>	<b>1/72</b>
220 V AC	12 A	S12	3	1 NO	101069	Ex9CS12 10 3P 220V	1/72
127 V AC	12 A	S12	3	1 NO	101070	Ex9CS12 10 3P 127V	1/72
110 V AC	12 A	S12	3	1 NO	101071	Ex9CS12 10 3P 110V	1/72
48 V AC	12 A	S12	3	1 NO	101072	Ex9CS12 10 3P 48V	1/72
42 V AC	12 A	S12	3	1 NO	101073	Ex9CS12 10 3P 42V	1/72
36 V AC	12 A	S12	3	1 NO	101074	Ex9CS12 10 3P 36V	1/72
<b>24 V AC</b>	<b>12 A</b>	<b>S12</b>	<b>3</b>	<b>1 NO</b>	<b>101075</b>	<b>Ex9CS12 10 3P 24V</b>	<b>1/72</b>

### Wiring diagrams

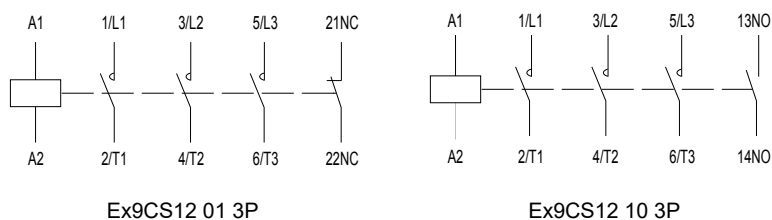

# Miniature contactors Ex9CS

## Rated current 12 A, 4-pole

- Miniature version of contactor
- Mounting onto device (DIN) rail 35 mm or onto panel
- Front-mounted auxiliary contacts AX41.. can be used



Control voltage	AC-3 $I_e$	Frame size	Poles	Auxiliary contacts	Article No.	Type	Packing
415 V AC	12 A	S12	4	-	101076	Ex9CS12 4P 415V	1/72
400 V AC	12 A	S12	4	-	101077	Ex9CS12 4P 400V	1/72
380 V AC	12 A	S12	4	-	101078	Ex9CS12 4P 380V	1/72
240 V AC	12 A	S12	4	-	101079	Ex9CS12 4P 240V	1/72
<b>230 V AC</b>	<b>12 A</b>	<b>S12</b>	<b>4</b>	-	<b>101080</b>	<b>Ex9CS12 4P 230V</b>	<b>1/72</b>
220 V AC	12 A	S12	4	-	101081	Ex9CS12 4P 220V	1/72
127 V AC	12 A	S12	4	-	101082	Ex9CS12 4P 127V	1/72
110 V AC	12 A	S12	4	-	101083	Ex9CS12 4P 110V	1/72
48 V AC	12 A	S12	4	-	101084	Ex9CS12 4P 48V	1/72
42 V AC	12 A	S12	4	-	101085	Ex9CS12 4P 42V	1/72
36 V AC	12 A	S12	4	-	101086	Ex9CS12 4P 36V	1/72
<b>24 V AC</b>	<b>12 A</b>	<b>S12</b>	<b>4</b>	-	<b>101087</b>	<b>Ex9CS12 4P 24V</b>	<b>1/72</b>
415 V AC	12 A	S12	2+2	-	101088	Ex9CS12 4P/22 415V	1/72
400 V AC	12 A	S12	2+2	-	101089	Ex9CS12 4P/22 400V	1/72
380 V AC	12 A	S12	2+2	-	101090	Ex9CS12 4P/22 380V	1/72
240 V AC	12 A	S12	2+2	-	101091	Ex9CS12 4P/22 240V	1/72
<b>230 V AC</b>	<b>12 A</b>	<b>S12</b>	<b>2+2</b>	-	<b>101092</b>	<b>Ex9CS12 4P/22 230V</b>	<b>1/72</b>
220 V AC	12 A	S12	2+2	-	101093	Ex9CS12 4P/22 220V	1/72
127 V AC	12 A	S12	2+2	-	101094	Ex9CS12 4P/22 127V	1/72
110 V AC	12 A	S12	2+2	-	101095	Ex9CS12 4P/22 110V	1/72
48 V AC	12 A	S12	2+2	-	101096	Ex9CS12 4P/22 48V	1/72
42 V AC	12 A	S12	2+2	-	101097	Ex9CS12 4P/22 42V	1/72
36 V AC	12 A	S12	2+2	-	101098	Ex9CS12 4P/22 36V	1/72
<b>24 V AC</b>	<b>12 A</b>	<b>S12</b>	<b>2+2</b>	-	<b>101099</b>	<b>Ex9CS12 4P/22 24V</b>	<b>1/72</b>

### Wiring diagrams

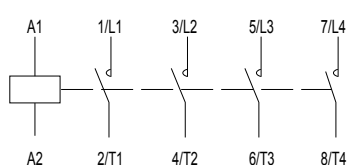

Ex9CS12 4P

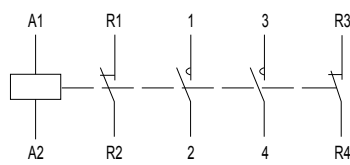

Ex9CS12 4P/22

# Miniature reversible contactors Ex9CSR



- Reversible combinations of miniature contactors
- Tested according to IEC / EN 60947-4-1
- 3 and 4-pole versions
- Rated current AC-3 6, 9 and 12 A at 400 V
- Coil control voltage 24 — 415 V AC
- Conditional short circuit current  $I_q = 50 \text{ kA}$
- Mechanical interlock
- Mounting onto device rail (DIN) 35 mm or onto panel

Miniature reversible contactors Ex9CSR brings excellent electric parameters in the form of very compact device. These contactors are used mainly for switching of asynchronous motors with possibility of change of rotation direction. They can also be used for switching two circuits when it is necessary to ensure that maximum one circuit is connected.

The combinations are equipped with mechanical interlock. Additional electrical interlock of control voltages (e.g. for EN 60204) can be implemented by means of auxiliary contacts AX42 or built-in auxiliary contacts.

Thanks to compact dimensions, Ex9CSR contactors are ideal solution for space limited installations.

The same function can be achieved by the combination of two contactors Ex9CS with mechanical interlock MIT41.

### Type Key

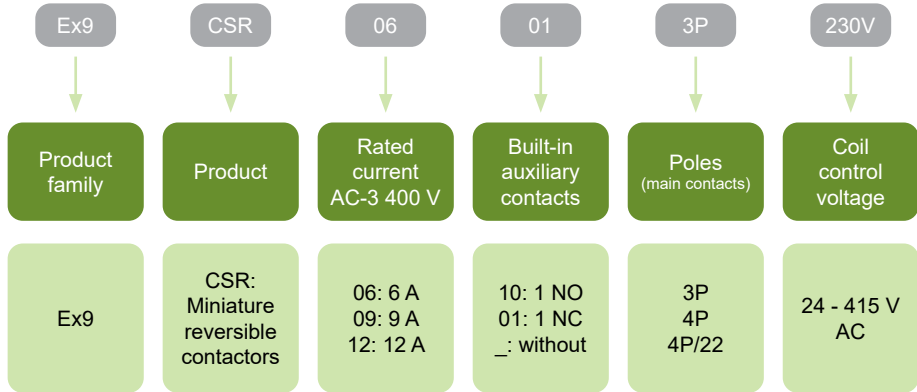

### Certification marks



# Miniature reversible contactors Ex9CSR

## Accessories

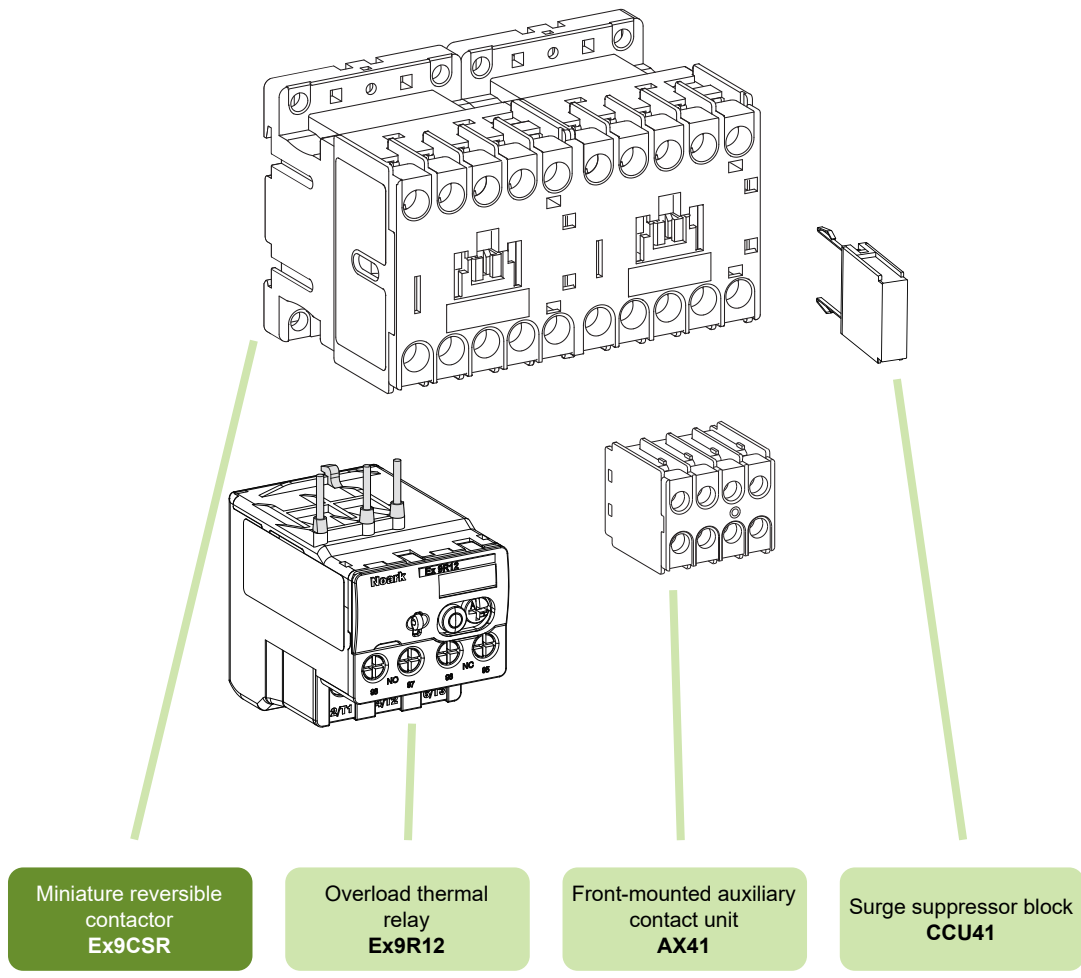

Auxiliary contacts AX41

see page 103

Overload thermal relays Ex9R12

see page 89

Surge suppressor block CCU41

see page 106



# Miniature reversible contactors Ex9CSR

## Rated current 6 A, 3-pole

- Miniature reversible version of contactor
- Mounting onto device (DIN) rail 35 mm or onto panel
- Front-mounted auxiliary contacts AX41.. can be used
- Can be combined with overload relays Ex9R12
- A number of built-in auxiliary contacts given belongs to single contactor unit in the pair



Control voltage	AC-3 $I_e$	Frame size	Poles	Auxiliary contacts	Article No.	Type	Packing
415 V AC	6 A	S12	3	1 NO	104506	Ex9CSR06 10 3P 415V	1/72
400 V AC	6 A	S12	3	1 NO	104507	Ex9CSR06 10 3P 400V	1/72
380 V AC	6 A	S12	3	1 NO	104508	Ex9CSR06 10 3P 380V	1/72
240 V AC	6 A	S12	3	1 NO	104511	Ex9CSR06 10 3P 240V	1/72
<b>230 V AC</b>	<b>6 A</b>	<b>S12</b>	<b>3</b>	<b>1 NO</b>	<b>104512</b>	<b>Ex9CSR06 10 3P 230V</b>	<b>1/72</b>
220 V AC	6 A	S12	3	1 NO	104513	Ex9CSR06 10 3P 220V	1/72
127 V AC	6 A	S12	3	1 NO	104514	Ex9CSR06 10 3P 127V	1/72
110 V AC	6 A	S12	3	1 NO	104515	Ex9CSR06 10 3P 110V	1/72
48 V AC	6 A	S12	3	1 NO	104504	Ex9CSR06 10 3P 48V	1/72
42 V AC	6 A	S12	3	1 NO	104505	Ex9CSR06 10 3P 42V	1/72
36 V AC	6 A	S12	3	1 NO	104509	Ex9CSR06 10 3P 36V	1/72
<b>24 V AC</b>	<b>6 A</b>	<b>S12</b>	<b>3</b>	<b>1 NO</b>	<b>104510</b>	<b>Ex9CSR06 10 3P 24V</b>	<b>1/72</b>
415 V AC	6 A	S12	3	1 NC	104518	Ex9CSR06 01 3P 415V	1/72
400 V AC	6 A	S12	3	1 NC	104519	Ex9CSR06 01 3P 400V	1/72
380 V AC	6 A	S12	3	1 NC	104520	Ex9CSR06 01 3P 380V	1/72
240 V AC	6 A	S12	3	1 NC	104523	Ex9CSR06 01 3P 240V	1/72
<b>230 V AC</b>	<b>6 A</b>	<b>S12</b>	<b>3</b>	<b>1 NC</b>	<b>104524</b>	<b>Ex9CSR06 01 3P 230V</b>	<b>1/72</b>
220 V AC	6 A	S12	3	1 NC	104525	Ex9CSR06 01 3P 220V	1/72
127 V AC	6 A	S12	3	1 NC	104526	Ex9CSR06 01 3P 127V	1/72
110 V AC	6 A	S12	3	1 NC	104527	Ex9CSR06 01 3P 110V	1/72
48 V AC	6 A	S12	3	1 NC	104516	Ex9CSR06 01 3P 48V	1/72
42 V AC	6 A	S12	3	1 NC	104517	Ex9CSR06 01 3P 42V	1/72
36 V AC	6 A	S12	3	1 NC	104521	Ex9CSR06 01 3P 36V	1/72
<b>24 V AC</b>	<b>6 A</b>	<b>S12</b>	<b>3</b>	<b>1 NC</b>	<b>104522</b>	<b>Ex9CSR06 01 3P 24V</b>	<b>1/72</b>

*Wiring diagrams*

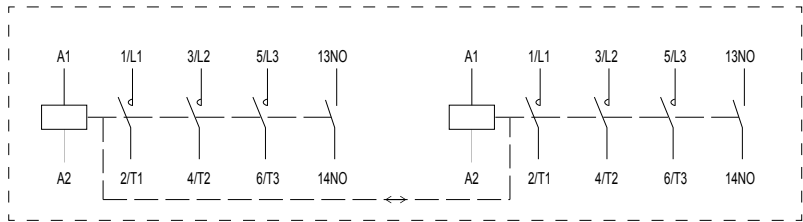

Ex9CSR 3P 1NO

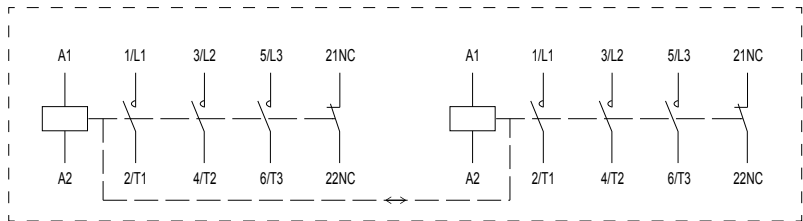

Ex9CSR 3P 1NC

# Miniature reversible contactors Ex9CSR

## Rated current 6 A, 4-pole

- Miniature reversible version of contactor
- Mounting onto device (DIN) rail 35 mm or onto panel
- Front-mounted auxiliary contacts AX41.. can be used
- A number of built-in auxiliary contacts given belongs to single contactor unit in the pair



Control voltage	AC-3 $I_e$	Frame size	Poles	Auxiliary contacts	Article No.	Type	Packing
415 V AC	6 A	S12	4P	-	104542	Ex9CSR06 4P 415V	1/72
400 V AC	6 A	S12	4P	-	104543	Ex9CSR06 4P 400V	1/72
380 V AC	6 A	S12	4P	-	104544	Ex9CSR06 4P 380V	1/72
240 V AC	6 A	S12	4P	-	104547	Ex9CSR06 4P 240V	1/72
<b>230 V AC</b>	<b>6 A</b>	<b>S12</b>	<b>4P</b>	-	<b>104548</b>	<b>Ex9CSR06 4P 230V</b>	<b>1/72</b>
220 V AC	6 A	S12	4P	-	104549	Ex9CSR06 4P 220V	1/72
127 V AC	6 A	S12	4P	-	104550	Ex9CSR06 4P 127V	1/72
110 V AC	6 A	S12	4P	-	104551	Ex9CSR06 4P 110V	1/72
48 V AC	6 A	S12	4P	-	104540	Ex9CSR06 4P 48V	1/72
42 V AC	6 A	S12	4P	-	104541	Ex9CSR06 4P 42V	1/72
36 V AC	6 A	S12	4P	-	104545	Ex9CSR06 4P 36V	1/72
<b>24 V AC</b>	<b>6 A</b>	<b>S12</b>	<b>4P</b>	-	<b>104546</b>	<b>Ex9CSR06 4P 24V</b>	<b>1/72</b>
415 V AC	6 A	S12	2+2	-	104530	Ex9CSR06 4P/22 415V	1/72
400 V AC	6 A	S12	2+2	-	104531	Ex9CSR06 4P/22 400V	1/72
380 V AC	6 A	S12	2+2	-	104532	Ex9CSR06 4P/22 380V	1/72
240 V AC	6 A	S12	2+2	-	104535	Ex9CSR06 4P/22 240V	1/72
<b>230 V AC</b>	<b>6 A</b>	<b>S12</b>	<b>2+2</b>	-	<b>104536</b>	<b>Ex9CSR06 4P/22 230V</b>	<b>1/72</b>
220 V AC	6 A	S12	2+2	-	104537	Ex9CSR06 4P/22 220V	1/72
127 V AC	6 A	S12	2+2	-	104538	Ex9CSR06 4P/22 127V	1/72
110 V AC	6 A	S12	2+2	-	104539	Ex9CSR06 4P/22 110V	1/72
48 V AC	6 A	S12	2+2	-	104528	Ex9CSR06 4P/22 48V	1/72
42 V AC	6 A	S12	2+2	-	104529	Ex9CSR06 4P/22 42V	1/72
36 V AC	6 A	S12	2+2	-	104533	Ex9CSR06 4P/22 36V	1/72
<b>24 V AC</b>	<b>6 A</b>	<b>S12</b>	<b>2+2</b>	-	<b>104534</b>	<b>Ex9CSR06 4P/22 24V</b>	<b>1/72</b>

### Wiring diagrams

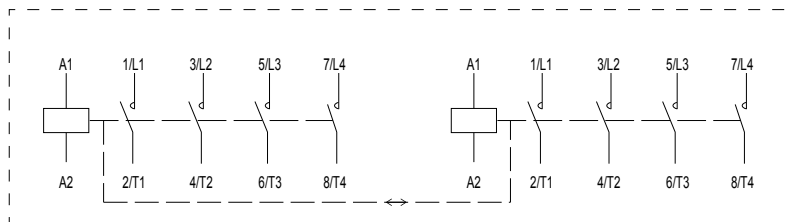

Ex9CSR 4P

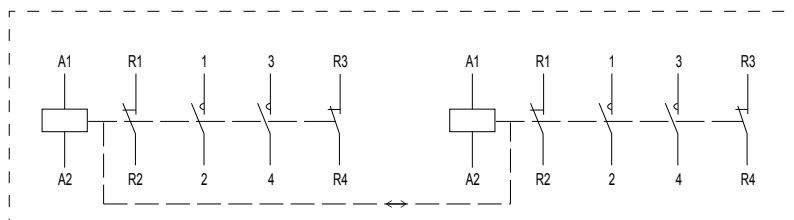

Ex9CSR 4P/22

# Miniature reversible contactors Ex9CSR

## Rated current 9 A, 3-pole

- Miniature reversible version of contactor
- Mounting onto device (DIN) rail 35 mm or onto panel
- Front-mounted auxiliary contacts AX41.. can be used
- Can be combined with overload relays Ex9R12
- A number of built-in auxiliary contacts given belongs to single contactor unit in the pair



Control voltage	AC-3 $I_e$	Frame size	Poles	Auxiliary contacts	Article No.	Type	Packing
415 V AC	9 A	S12	3P	1 NO	104554	Ex9CSR09 10 3P 415V	1/72
400 V AC	9 A	S12	3P	1 NO	104555	Ex9CSR09 10 3P 400V	1/72
380 V AC	9 A	S12	3P	1 NO	104556	Ex9CSR09 10 3P 380V	1/72
240 V AC	9 A	S12	3P	1 NO	104559	Ex9CSR09 10 3P 240V	1/72
<b>230 V AC</b>	<b>9 A</b>	<b>S12</b>	<b>3P</b>	<b>1 NO</b>	<b>104560</b>	<b>Ex9CSR09 10 3P 230V</b>	<b>1/72</b>
220 V AC	9 A	S12	3P	1 NO	104561	Ex9CSR09 10 3P 220V	1/72
127 V AC	9 A	S12	3P	1 NO	104562	Ex9CSR09 10 3P 127V	1/72
110 V AC	9 A	S12	3P	1 NO	104563	Ex9CSR09 10 3P 110V	1/72
48 V AC	9 A	S12	3P	1 NO	104552	Ex9CSR09 10 3P 48V	1/72
42 V AC	9 A	S12	3P	1 NO	104553	Ex9CSR09 10 3P 42V	1/72
36 V AC	9 A	S12	3P	1 NO	104557	Ex9CSR09 10 3P 36V	1/72
<b>24 V AC</b>	<b>9 A</b>	<b>S12</b>	<b>3P</b>	<b>1 NO</b>	<b>104558</b>	<b>Ex9CSR09 10 3P 24V</b>	<b>1/72</b>
415 V AC	9 A	S12	3P	1 NC	104566	Ex9CSR09 01 3P 415V	1/72
400 V AC	9 A	S12	3P	1 NC	104567	Ex9CSR09 01 3P 400V	1/72
380 V AC	9 A	S12	3P	1 NC	104568	Ex9CSR09 01 3P 380V	1/72
240 V AC	9 A	S12	3P	1 NC	104571	Ex9CSR09 01 3P 240V	1/72
<b>230 V AC</b>	<b>9 A</b>	<b>S12</b>	<b>3P</b>	<b>1 NC</b>	<b>104572</b>	<b>Ex9CSR09 01 3P 230V</b>	<b>1/72</b>
220 V AC	9 A	S12	3P	1 NC	104573	Ex9CSR09 01 3P 220V	1/72
127 V AC	9 A	S12	3P	1 NC	104574	Ex9CSR09 01 3P 127V	1/72
110 V AC	9 A	S12	3P	1 NC	104575	Ex9CSR09 01 3P 110V	1/72
48 V AC	9 A	S12	3P	1 NC	104564	Ex9CSR09 01 3P 48V	1/72
42 V AC	9 A	S12	3P	1 NC	104565	Ex9CSR09 01 3P 42V	1/72
36 V AC	9 A	S12	3P	1 NC	104569	Ex9CSR09 01 3P 36V	1/72
<b>24 V AC</b>	<b>9 A</b>	<b>S12</b>	<b>3P</b>	<b>1 NC</b>	<b>104570</b>	<b>Ex9CSR09 01 3P 24V</b>	<b>1/72</b>

### Wiring diagrams

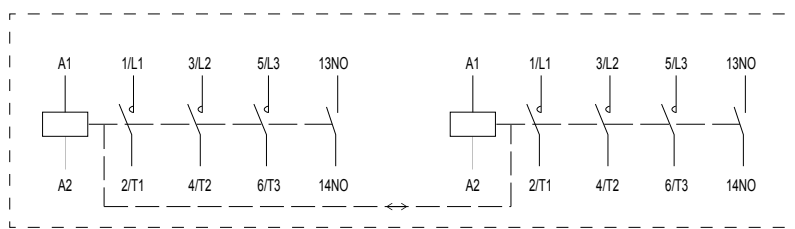

Ex9CSR 3P 1NO

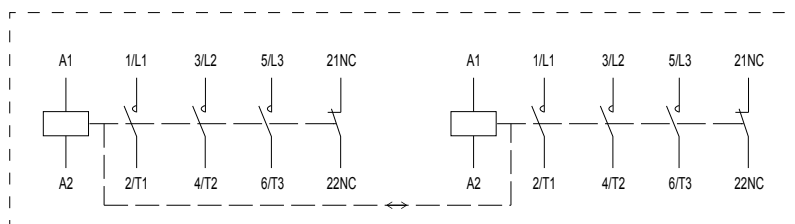

Ex9CSR 3P 1NC

# Miniature reversible contactors Ex9CSR

## Rated current 9 A, 4-pole

- Miniature reversible version of contactor
- Mounting onto device (DIN) rail 35 mm or onto panel
- Front-mounted auxiliary contacts AX41.. can be used
- A number of built-in auxiliary contacts given belongs to single contactor unit in the pair



Control voltage	AC-3 $I_e$	Frame size	Poles	Auxiliary contacts	Article No.	Type	Packing
415 V AC	9 A	S12	4P	-	104590	Ex9CSR09 4P 415V	1/72
400 V AC	9 A	S12	4P	-	104591	Ex9CSR09 4P 400V	1/72
380 V AC	9 A	S12	4P	-	104592	Ex9CSR09 4P 380V	1/72
240 V AC	9 A	S12	4P	-	104595	Ex9CSR09 4P 240V	1/72
<b>230 V AC</b>	<b>9 A</b>	<b>S12</b>	<b>4P</b>	-	<b>104596</b>	<b>Ex9CSR09 4P 230V</b>	<b>1/72</b>
220 V AC	9 A	S12	4P	-	104597	Ex9CSR09 4P 220V	1/72
127 V AC	9 A	S12	4P	-	104598	Ex9CSR09 4P 127V	1/72
110 V AC	9 A	S12	4P	-	104599	Ex9CSR09 4P 110V	1/72
48 V AC	9 A	S12	4P	-	104588	Ex9CSR09 4P 48V	1/72
42 V AC	9 A	S12	4P	-	104589	Ex9CSR09 4P 42V	1/72
36 V AC	9 A	S12	4P	-	104593	Ex9CSR09 4P 36V	1/72
<b>24 V AC</b>	<b>9 A</b>	<b>S12</b>	<b>4P</b>	-	<b>104594</b>	<b>Ex9CSR09 4P 24V</b>	<b>1/72</b>
415 V AC	9 A	S12	2+2	-	104578	Ex9CSR09 4P/22 415V	1/72
400 V AC	9 A	S12	2+2	-	104579	Ex9CSR09 4P/22 400V	1/72
380 V AC	9 A	S12	2+2	-	104580	Ex9CSR09 4P/22 380V	1/72
240 V AC	9 A	S12	2+2	-	104583	Ex9CSR09 4P/22 240V	1/72
<b>230 V AC</b>	<b>9 A</b>	<b>S12</b>	<b>2+2</b>	-	<b>104584</b>	<b>Ex9CSR09 4P/22 230V</b>	<b>1/72</b>
220 V AC	9 A	S12	2+2	-	104585	Ex9CSR09 4P/22 220V	1/72
127 V AC	9 A	S12	2+2	-	104586	Ex9CSR09 4P/22 127V	1/72
110 V AC	9 A	S12	2+2	-	104587	Ex9CSR09 4P/22 110V	1/72
48 V AC	9 A	S12	2+2	-	104576	Ex9CSR09 4P/22 48V	1/72
42 V AC	9 A	S12	2+2	-	104577	Ex9CSR09 4P/22 42V	1/72
36 V AC	9 A	S12	2+2	-	104581	Ex9CSR09 4P/22 36V	1/72
<b>24 V AC</b>	<b>9 A</b>	<b>S12</b>	<b>2+2</b>	-	<b>104582</b>	<b>Ex9CSR09 4P/22 24V</b>	<b>1/72</b>

### Wiring diagrams

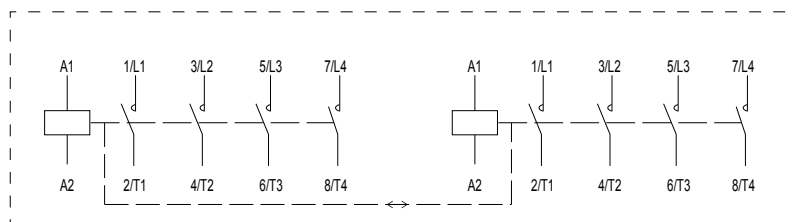

Ex9CSR 4P

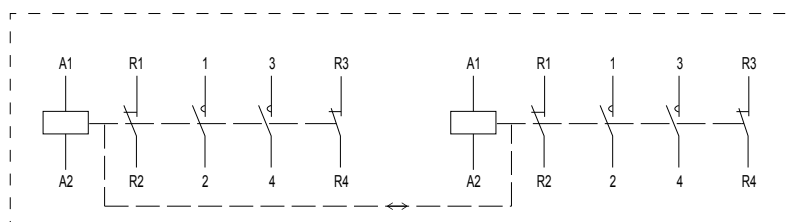

Ex9CSR 4P/22

# Miniature reversible contactors Ex9CSR

## Rated current 12 A, 3-pole

- Miniature reversible version of contactor
- Mounting onto device (DIN) rail 35 mm or onto panel
- Front-mounted auxiliary contacts AX41.. can be used
- Can be combined with overload relays Ex9R12
- A number of built-in auxiliary contacts given belongs to single contactor unit in the pair



Control voltage	AC-3 $I_e$	Frame size	Poles	Auxiliary contacts	Article No.	Type	Packing
415 V AC	12 A	S12	3P	1 NO	104602	Ex9CSR12 10 3P 415V	1/72
400 V AC	12 A	S12	3P	1 NO	104603	Ex9CSR12 10 3P 400V	1/72
380 V AC	12 A	S12	3P	1 NO	104604	Ex9CSR12 10 3P 380V	1/72
240 V AC	12 A	S12	3P	1 NO	104607	Ex9CSR12 10 3P 240V	1/72
<b>230 V AC</b>	<b>12 A</b>	<b>S12</b>	<b>3P</b>	<b>1 NO</b>	<b>104608</b>	<b>Ex9CSR12 10 3P 230V</b>	<b>1/72</b>
220 V AC	12 A	S12	3P	1 NO	104609	Ex9CSR12 10 3P 220V	1/72
127 V AC	12 A	S12	3P	1 NO	104610	Ex9CSR12 10 3P 127V	1/72
110 V AC	12 A	S12	3P	1 NO	104611	Ex9CSR12 10 3P 110V	1/72
48 V AC	12 A	S12	3P	1 NO	104600	Ex9CSR12 10 3P 48V	1/72
42 V AC	12 A	S12	3P	1 NO	104601	Ex9CSR12 10 3P 42V	1/72
36 V AC	12 A	S12	3P	1 NO	104605	Ex9CSR12 10 3P 36V	1/72
<b>24 V AC</b>	<b>12 A</b>	<b>S12</b>	<b>3P</b>	<b>1 NO</b>	<b>104606</b>	<b>Ex9CSR12 10 3P 24V</b>	<b>1/72</b>
415 V AC	12 A	S12	3P	1 NC	104614	Ex9CSR12 01 3P 415V	1/72
400 V AC	12 A	S12	3P	1 NC	104615	Ex9CSR12 01 3P 400V	1/72
380 V AC	12 A	S12	3P	1 NC	104616	Ex9CSR12 01 3P 380V	1/72
240 V AC	12 A	S12	3P	1 NC	104619	Ex9CSR12 01 3P 240V	1/72
<b>230 V AC</b>	<b>12 A</b>	<b>S12</b>	<b>3P</b>	<b>1 NC</b>	<b>104620</b>	<b>Ex9CSR12 01 3P 230V</b>	<b>1/72</b>
220 V AC	12 A	S12	3P	1 NC	104621	Ex9CSR12 01 3P 220V	1/72
127 V AC	12 A	S12	3P	1 NC	104622	Ex9CSR12 01 3P 127V	1/72
110 V AC	12 A	S12	3P	1 NC	104623	Ex9CSR12 01 3P 110V	1/72
48 V AC	12 A	S12	3P	1 NC	104612	Ex9CSR12 01 3P 48V	1/72
42 V AC	12 A	S12	3P	1 NC	104613	Ex9CSR12 01 3P 42V	1/72
36 V AC	12 A	S12	3P	1 NC	104617	Ex9CSR12 01 3P 36V	1/72
<b>24 V AC</b>	<b>12 A</b>	<b>S12</b>	<b>3P</b>	<b>1 NC</b>	<b>104618</b>	<b>Ex9CSR12 01 3P 24V</b>	<b>1/72</b>

### Wiring diagrams

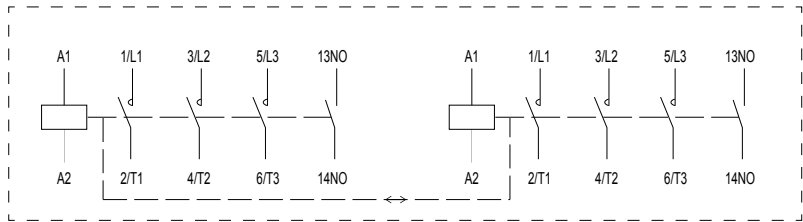

Ex9CSR 3P 1NO

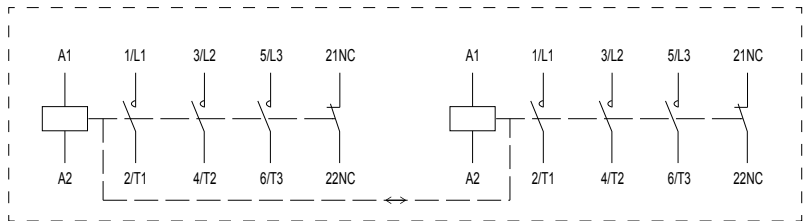

Ex9CSR 3P 1NC

# Miniature reversible contactors Ex9CSR

## Rated current 12 A, 4-pole

- Miniature reversible version of contactor
- Mounting onto device (DIN) rail 35 mm or onto panel
- Front-mounted auxiliary contacts AX41.. can be used
- A number of built-in auxiliary contacts given belongs to single contactor unit in the pair



Control voltage	AC-3 $I_e$	Frame size	Poles	Auxiliary contacts	Article No.	Type	Packing
415 V AC	12 A	S12	4P	-	104638	Ex9CSR12 4P 415V	1/72
400 V AC	12 A	S12	4P	-	104639	Ex9CSR12 4P 400V	1/72
380 V AC	12 A	S12	4P	-	104640	Ex9CSR12 4P 380V	1/72
240 V AC	12 A	S12	4P	-	104643	Ex9CSR12 4P 240V	1/72
<b>230 V AC</b>	<b>12 A</b>	<b>S12</b>	<b>4P</b>	-	<b>104644</b>	<b>Ex9CSR12 4P 230V</b>	<b>1/72</b>
220 V AC	12 A	S12	4P	-	104645	Ex9CSR12 4P 220V	1/72
127 V AC	12 A	S12	4P	-	104646	Ex9CSR12 4P 127V	1/72
110 V AC	12 A	S12	4P	-	104647	Ex9CSR12 4P 110V	1/72
48 V AC	12 A	S12	4P	-	104636	Ex9CSR12 4P 48V	1/72
42 V AC	12 A	S12	4P	-	104637	Ex9CSR12 4P 42V	1/72
36 V AC	12 A	S12	4P	-	104641	Ex9CSR12 4P 36V	1/72
<b>24 V AC</b>	<b>12 A</b>	<b>S12</b>	<b>4P</b>	-	<b>104642</b>	<b>Ex9CSR12 4P 24V</b>	<b>1/72</b>
415 V AC	12 A	S12	2+2	-	104626	Ex9CSR12 4P/22 415V	1/72
400 V AC	12 A	S12	2+2	-	104627	Ex9CSR12 4P/22 400V	1/72
380 V AC	12 A	S12	2+2	-	104628	Ex9CSR12 4P/22 380V	1/72
240 V AC	12 A	S12	2+2	-	104631	Ex9CSR12 4P/22 240V	1/72
<b>230 V AC</b>	<b>12 A</b>	<b>S12</b>	<b>2+2</b>	-	<b>104632</b>	<b>Ex9CSR12 4P/22 230V</b>	<b>1/72</b>
220 V AC	12 A	S12	2+2	-	104633	Ex9CSR12 4P/22 220V	1/72
127 V AC	12 A	S12	2+2	-	104634	Ex9CSR12 4P/22 127V	1/72
110 V AC	12 A	S12	2+2	-	104635	Ex9CSR12 4P/22 110V	1/72
48 V AC	12 A	S12	2+2	-	104624	Ex9CSR12 4P/22 48V	1/72
42 V AC	12 A	S12	2+2	-	104625	Ex9CSR12 4P/22 42V	1/72
36 V AC	12 A	S12	2+2	-	104629	Ex9CSR12 4P/22 36V	1/72
<b>24 V AC</b>	<b>12 A</b>	<b>S12</b>	<b>2+2</b>	-	<b>104630</b>	<b>Ex9CSR12 4P/22 24V</b>	<b>1/72</b>

### Wiring diagrams

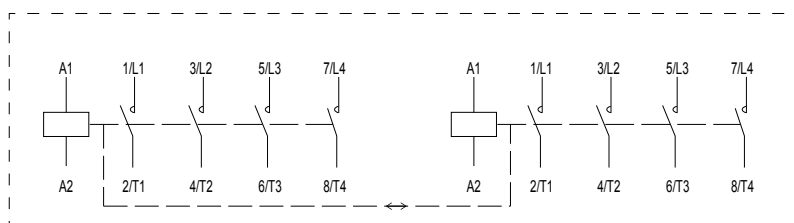

Ex9CSR 4P

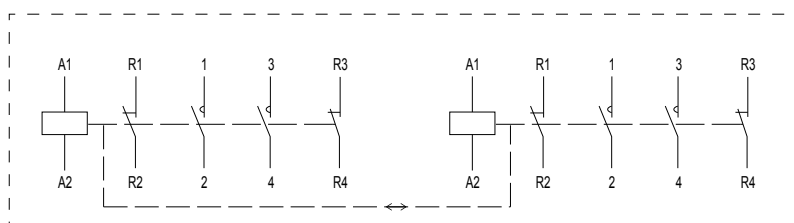

Ex9CSR 4P/22

# Contactors Ex9C up to 100 A



- Contactors according to IEC / EN 60947-4-1
- Four frame sizes with rated current up to 100 A at 400 V AC-3
- 3-pole versions
- Coil control voltage 24 — 415 V AC
- Rated conditional short circuit current  $I_q = 50 \text{ kA}$
- Suitable mainly for industrial applications, can be used also for domestic ones
- Mounting onto device rail (DIN) 35 or 75 mm (frame sizes 65 and 100) or onto panel

Ex9C contactors are intended for various applications including heavy industrial ones. Splitting into four frame sizes brings optimization of electrical parameters and mechanical dimensions. All these frame sizes share accessory auxiliary contacts. Overload relays Ex9R differ with the frame sizes in order to fit respective contactor of given rated current.

Frame size 18 contains contactors with rated currents AC-3 9, 12 and 18 A at 400 V. Size 38 consists of rated currents 25, 32, 38 A. Version 65 is splitted into currents 40, 50 and 65 A. Finally frame size 100 is covered with rated currents 80 and 100 A.

### Type Key

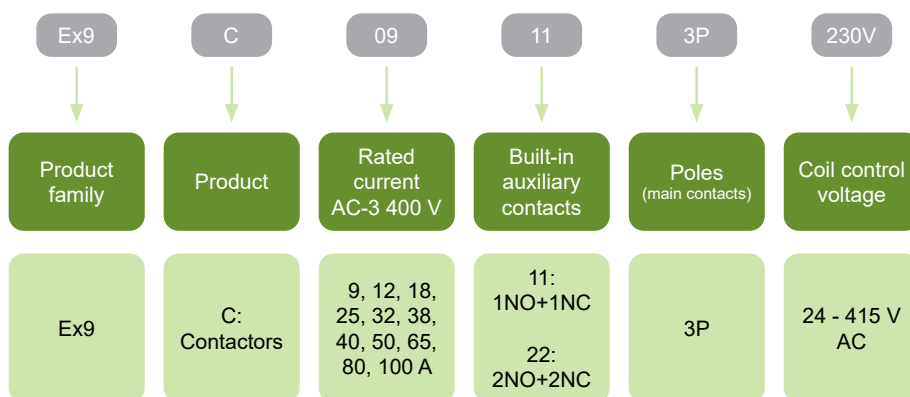

### Certification marks



# Contactors Ex9C up to 100 A

## Frame sizes



**Frame size 18**  
Rated currents 9, 12, 18 A



**Frame size 38**  
Rated currents 25, 32, 38 A



**Frame size 65**  
Rated currents 40, 50, 65 A



**Frame size 100**  
Rated currents 80, 100 A



# Contactors Ex9C up to 100 A

## Accessories

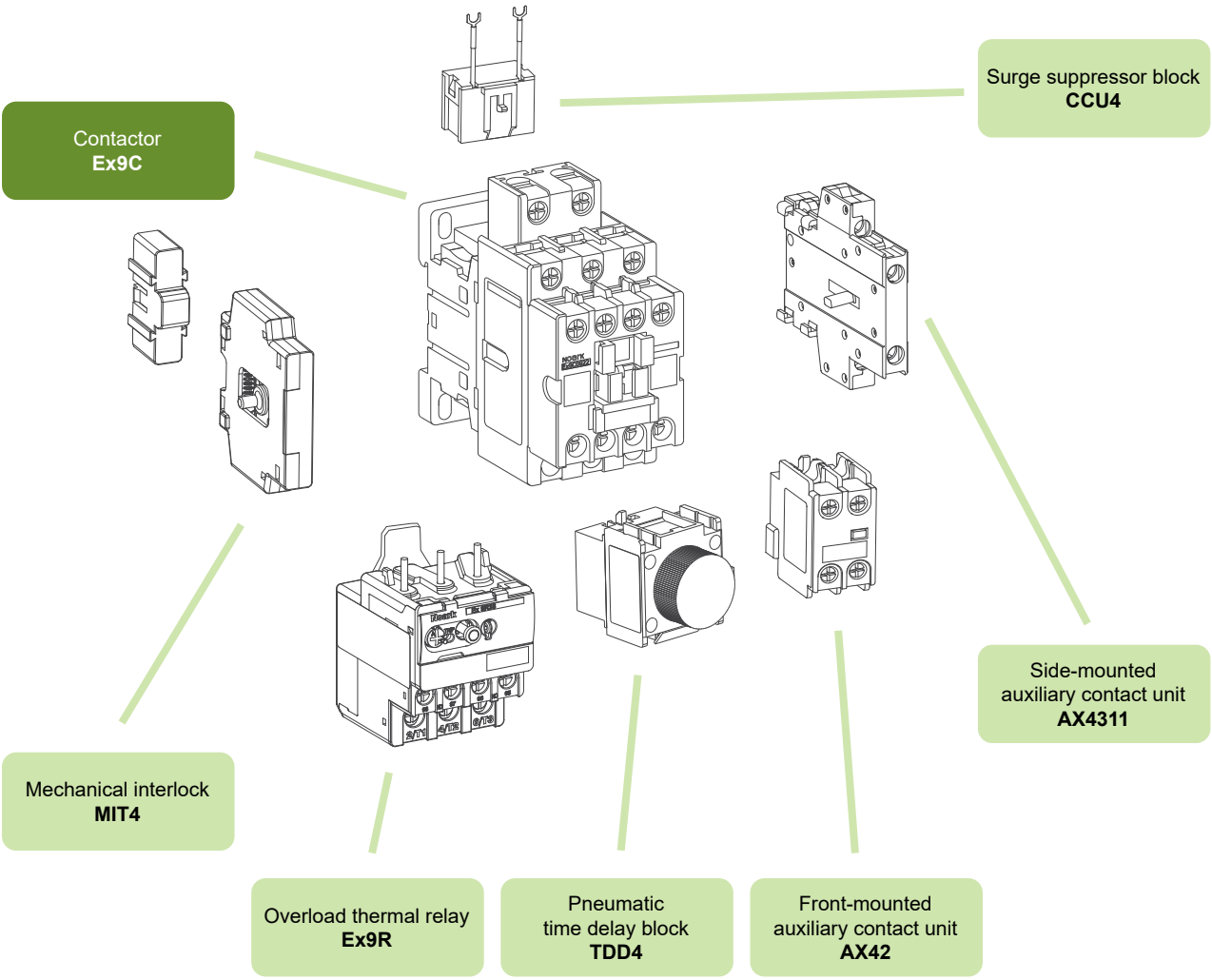

Auxiliary contacts AX4311	see page 104
Auxiliary contacts AX42	see page 104
Overload thermal relays Ex9R	see page 87
Pneumatic time delay block TDD4	see page 106
Surge suppressor block CCU4	see page 106
Mechanical interlock MIT4	see page 105

# Contactors Ex9C, frame size 18

## Rated current 9 A, 3-pole

- Standard version of contactor
- Mounting onto device (DIN) rail 35 mm or onto panel
- Front-mounted auxiliary contacts AX42.. as well as side-mounted ones AX43 can be used
- Can be combined with overload relays Ex9R38M



Control Voltage	$I_e$	Frame size	Poles	Auxiliary contacts	Article No.	Type	Packing
415 V AC	9 A	18	3	1 NO + 1 NC	101100	Ex9C09 11 3P 415V	1/40
400 V AC	9 A	18	3	1 NO + 1 NC	101101	Ex9C09 11 3P 400V	1/40
380 V AC	9 A	18	3	1 NO + 1 NC	101102	Ex9C09 11 3P 380V	1/40
240 V AC	9 A	18	3	1 NO + 1 NC	101103	Ex9C09 11 3P 240V	1/40
<b>230 V AC</b>	<b>9 A</b>	<b>18</b>	<b>3</b>	<b>1 NO + 1 NC</b>	<b>101104</b>	<b>Ex9C09 11 3P 230V</b>	<b>1/40</b>
220 V AC	9 A	18	3	1 NO + 1 NC	101105	Ex9C09 11 3P 220V	1/40
127 V AC	9 A	18	3	1 NO + 1 NC	101106	Ex9C09 11 3P 127V	1/40
110 V AC	9 A	18	3	1 NO + 1 NC	101107	Ex9C09 11 3P 110V	1/40
48 V AC	9 A	18	3	1 NO + 1 NC	101108	Ex9C09 11 3P 48V	1/40
42 V AC	9 A	18	3	1 NO + 1 NC	101109	Ex9C09 11 3P 42V	1/40
36 V AC	9 A	18	3	1 NO + 1 NC	101110	Ex9C09 11 3P 36V	1/40
<b>24 V AC</b>	<b>9 A</b>	<b>18</b>	<b>3</b>	<b>1 NO + 1 NC</b>	<b>101111</b>	<b>Ex9C09 11 3P 24V</b>	<b>1/40</b>
415 V AC	9 A	18	3	2 NO + 2 NC	101112	Ex9C09 22 3P 415V	1/40
400 V AC	9 A	18	3	2 NO + 2 NC	101113	Ex9C09 22 3P 400V	1/40
380 V AC	9 A	18	3	2 NO + 2 NC	101114	Ex9C09 22 3P 380V	1/40
240 V AC	9 A	18	3	2 NO + 2 NC	101115	Ex9C09 22 3P 240V	1/40
<b>230 V AC</b>	<b>9 A</b>	<b>18</b>	<b>3</b>	<b>2 NO + 2 NC</b>	<b>101116</b>	<b>Ex9C09 22 3P 230V</b>	<b>1/40</b>
220 V AC	9 A	18	3	2 NO + 2 NC	101117	Ex9C09 22 3P 220V	1/40
127 V AC	9 A	18	3	2 NO + 2 NC	101118	Ex9C09 22 3P 127V	1/40
110 V AC	9 A	18	3	2 NO + 2 NC	101119	Ex9C09 22 3P 110V	1/40
48 V AC	9 A	18	3	2 NO + 2 NC	101120	Ex9C09 22 3P 48V	1/40
42 V AC	9 A	18	3	2 NO + 2 NC	101121	Ex9C09 22 3P 42V	1/40
36 V AC	9 A	18	3	2 NO + 2 NC	101122	Ex9C09 22 3P 36V	1/40
<b>24 V AC</b>	<b>9 A</b>	<b>18</b>	<b>3</b>	<b>2 NO + 2 NC</b>	<b>101123</b>	<b>Ex9C09 22 3P 24V</b>	<b>1/40</b>

### Wiring diagrams

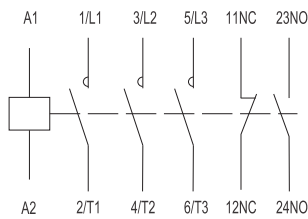

Ex9C09 11 3P

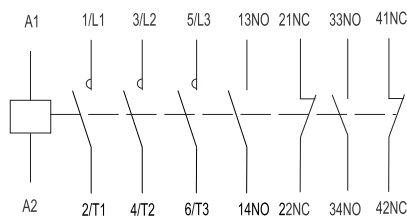

Ex9C09 22 3P

# Contactors Ex9C, frame size 18

## Rated current 12 A, 3-pole

- Standard version of contactor
- Mounting onto device (DIN) rail 35 mm or onto panel
- Front-mounted auxiliary contacts AX42.. as well as side-mounted ones AX43 can be used
- Can be combined with overload relays Ex9R38M



Control Voltage	$I_e$	Frame size	Poles	Auxiliary contacts	Article No.	Type	Packing
415 V AC	12 A	18	3	1 NO + 1 NC	101124	Ex9C12 11 3P 415V	1/40
400 V AC	12 A	18	3	1 NO + 1 NC	101125	Ex9C12 11 3P 400V	1/40
380 V AC	12 A	18	3	1 NO + 1 NC	101126	Ex9C12 11 3P 380V	1/40
240 V AC	12 A	18	3	1 NO + 1 NC	101127	Ex9C12 11 3P 240V	1/40
<b>230 V AC</b>	<b>12 A</b>	<b>18</b>	<b>3</b>	<b>1 NO + 1 NC</b>	<b>101128</b>	<b>Ex9C12 11 3P 230V</b>	<b>1/40</b>
220 V AC	12 A	18	3	1 NO + 1 NC	101129	Ex9C12 11 3P 220V	1/40
127 V AC	12 A	18	3	1 NO + 1 NC	101130	Ex9C12 11 3P 127V	1/40
110 V AC	12 A	18	3	1 NO + 1 NC	101131	Ex9C12 11 3P 110V	1/40
48 V AC	12 A	18	3	1 NO + 1 NC	101132	Ex9C12 11 3P 48V	1/40
42 V AC	12 A	18	3	1 NO + 1 NC	101133	Ex9C12 11 3P 42V	1/40
36 V AC	12 A	18	3	1 NO + 1 NC	101134	Ex9C12 11 3P 36V	1/40
<b>24 V AC</b>	<b>12 A</b>	<b>18</b>	<b>3</b>	<b>1 NO + 1 NC</b>	<b>101135</b>	<b>Ex9C12 11 3P 24V</b>	<b>1/40</b>
415 V AC	12 A	18	3	2 NO + 2 NC	101136	Ex9C12 22 3P 415V	1/40
400 V AC	12 A	18	3	2 NO + 2 NC	101137	Ex9C12 22 3P 400V	1/40
380 V AC	12 A	18	3	2 NO + 2 NC	101138	Ex9C12 22 3P 380V	1/40
240 V AC	12 A	18	3	2 NO + 2 NC	101139	Ex9C12 22 3P 240V	1/40
<b>230 V AC</b>	<b>12 A</b>	<b>18</b>	<b>3</b>	<b>2 NO + 2 NC</b>	<b>101140</b>	<b>Ex9C12 22 3P 230V</b>	<b>1/40</b>
220 V AC	12 A	18	3	2 NO + 2 NC	101141	Ex9C12 22 3P 220V	1/40
127 V AC	12 A	18	3	2 NO + 2 NC	101142	Ex9C12 22 3P 127V	1/40
110 V AC	12 A	18	3	2 NO + 2 NC	101143	Ex9C12 22 3P 110V	1/40
48 V AC	12 A	18	3	2 NO + 2 NC	101144	Ex9C12 22 3P 48V	1/40
42 V AC	12 A	18	3	2 NO + 2 NC	101145	Ex9C12 22 3P 42V	1/40
36 V AC	12 A	18	3	2 NO + 2 NC	101146	Ex9C12 22 3P 36V	1/40
<b>24 V AC</b>	<b>12 A</b>	<b>18</b>	<b>3</b>	<b>2 NO + 2 NC</b>	<b>101147</b>	<b>Ex9C12 22 3P 24V</b>	<b>1/40</b>

### Wiring diagrams

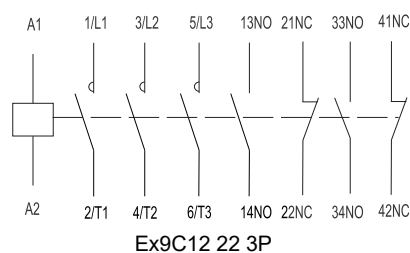
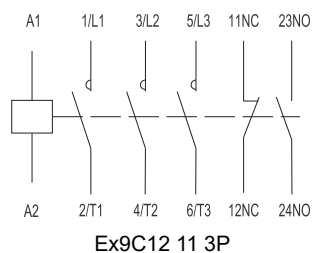

# Contactors Ex9C, frame size 18

## Rated current 18 A, 3-pole

- Standard version of contactor
- Mounting onto device (DIN) rail 35 mm or onto panel
- Front-mounted auxiliary contacts AX42.. as well as side-mounted ones AX43 can be used
- Can be combined with overload relays Ex9R38M



Control Voltage	$I_e$	Frame size	Poles	Auxiliary contacts	Article No.	Type	Packing
415 V AC	18 A	18	3	1 NO + 1 NC	101148	Ex9C18 11 3P 415V	1/40
400 V AC	18 A	18	3	1 NO + 1 NC	101149	Ex9C18 11 3P 400V	1/40
380 V AC	18 A	18	3	1 NO + 1 NC	101150	Ex9C18 11 3P 380V	1/40
240 V AC	18 A	18	3	1 NO + 1 NC	101151	Ex9C18 11 3P 240V	1/40
<b>230 V AC</b>	<b>18 A</b>	<b>18</b>	<b>3</b>	<b>1 NO + 1 NC</b>	<b>101152</b>	<b>Ex9C18 11 3P 230V</b>	<b>1/40</b>
220 V AC	18 A	18	3	1 NO + 1 NC	101153	Ex9C18 11 3P 220V	1/40
127 V AC	18 A	18	3	1 NO + 1 NC	101154	Ex9C18 11 3P 127V	1/40
110 V AC	18 A	18	3	1 NO + 1 NC	101155	Ex9C18 11 3P 110V	1/40
48 V AC	18 A	18	3	1 NO + 1 NC	101156	Ex9C18 11 3P 48V	1/40
42 V AC	18 A	18	3	1 NO + 1 NC	101157	Ex9C18 11 3P 42V	1/40
36 V AC	18 A	18	3	1 NO + 1 NC	101158	Ex9C18 11 3P 36V	1/40
<b>24 V AC</b>	<b>18 A</b>	<b>18</b>	<b>3</b>	<b>1 NO + 1 NC</b>	<b>101159</b>	<b>Ex9C18 11 3P 24V</b>	<b>1/40</b>
415 V AC	18 A	18	3	2 NO + 2 NC	101160	Ex9C18 22 3P 415V	1/40
400 V AC	18 A	18	3	2 NO + 2 NC	101161	Ex9C18 22 3P 400V	1/40
380 V AC	18 A	18	3	2 NO + 2 NC	101162	Ex9C18 22 3P 380V	1/40
240 V AC	18 A	18	3	2 NO + 2 NC	101163	Ex9C18 22 3P 240V	1/40
<b>230 V AC</b>	<b>18 A</b>	<b>18</b>	<b>3</b>	<b>2 NO + 2 NC</b>	<b>101164</b>	<b>Ex9C18 22 3P 230V</b>	<b>1/40</b>
220 V AC	18 A	18	3	2 NO + 2 NC	101165	Ex9C18 22 3P 220V	1/40
127 V AC	18 A	18	3	2 NO + 2 NC	101166	Ex9C18 22 3P 127V	1/40
110 V AC	18 A	18	3	2 NO + 2 NC	101167	Ex9C18 22 3P 110V	1/40
48 V AC	18 A	18	3	2 NO + 2 NC	101168	Ex9C18 22 3P 48V	1/40
42 V AC	18 A	18	3	2 NO + 2 NC	101169	Ex9C18 22 3P 42V	1/40
36 V AC	18 A	18	3	2 NO + 2 NC	101170	Ex9C18 22 3P 36V	1/40
<b>24 V AC</b>	<b>18 A</b>	<b>18</b>	<b>3</b>	<b>2 NO + 2 NC</b>	<b>101171</b>	<b>Ex9C18 22 3P 24V</b>	<b>1/40</b>

### Wiring diagrams

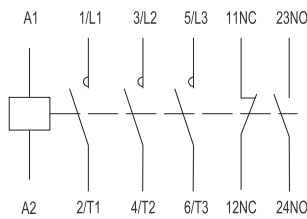

Ex9C18 11 3P

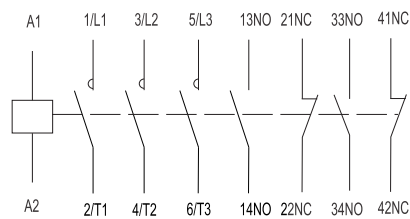

Ex9C18 22 3P

# Contactors Ex9C, frame size 38

## Rated current 25 A, 3-pole

- Standard version of contactor
- Mounting onto device (DIN) rail 35 mm or onto panel
- Front-mounted auxiliary contacts AX42.. as well as side-mounted ones AX43 can be used
- Can be combined with overload relays Ex9R38M



Control Voltage	$I_e$	Frame size	Poles	Auxiliary contacts	Article No.	Type	Packing
415 V AC	25 A	38	3	1 NO + 1 NC	101172	Ex9C25 11 3P 415V	1/20
400 V AC	25 A	38	3	1 NO + 1 NC	101173	Ex9C25 11 3P 400V	1/20
380 V AC	25 A	38	3	1 NO + 1 NC	101174	Ex9C25 11 3P 380V	1/20
240 V AC	25 A	38	3	1 NO + 1 NC	101175	Ex9C25 11 3P 240V	1/20
<b>230 V AC</b>	<b>25 A</b>	<b>38</b>	<b>3</b>	<b>1 NO + 1 NC</b>	<b>101176</b>	<b>Ex9C25 11 3P 230V</b>	<b>1/20</b>
220 V AC	25 A	38	3	1 NO + 1 NC	101177	Ex9C25 11 3P 220V	1/20
127 V AC	25 A	38	3	1 NO + 1 NC	101178	Ex9C25 11 3P 127V	1/20
110 V AC	25 A	38	3	1 NO + 1 NC	101179	Ex9C25 11 3P 110V	1/20
48 V AC	25 A	38	3	1 NO + 1 NC	101180	Ex9C25 11 3P 48V	1/20
42 V AC	25 A	38	3	1 NO + 1 NC	101181	Ex9C25 11 3P 42V	1/20
36 V AC	25 A	38	3	1 NO + 1 NC	101182	Ex9C25 11 3P 36V	1/20
<b>24 V AC</b>	<b>25 A</b>	<b>38</b>	<b>3</b>	<b>1 NO + 1 NC</b>	<b>101183</b>	<b>Ex9C25 11 3P 24V</b>	<b>1/20</b>
415 V AC	25 A	38	3	2 NO + 2 NC	101184	Ex9C25 22 3P 415V	1/20
400 V AC	25 A	38	3	2 NO + 2 NC	101185	Ex9C25 22 3P 400V	1/20
380 V AC	25 A	38	3	2 NO + 2 NC	101186	Ex9C25 22 3P 380V	1/20
240 V AC	25 A	38	3	2 NO + 2 NC	101187	Ex9C25 22 3P 240V	1/20
<b>230 V AC</b>	<b>25 A</b>	<b>38</b>	<b>3</b>	<b>2 NO + 2 NC</b>	<b>101188</b>	<b>Ex9C25 22 3P 230V</b>	<b>1/20</b>
220 V AC	25 A	38	3	2 NO + 2 NC	101189	Ex9C25 22 3P 220V	1/20
127 V AC	25 A	38	3	2 NO + 2 NC	101190	Ex9C25 22 3P 127V	1/20
110 V AC	25 A	38	3	2 NO + 2 NC	101191	Ex9C25 22 3P 110V	1/20
48 V AC	25 A	38	3	2 NO + 2 NC	101192	Ex9C25 22 3P 48V	1/20
42 V AC	25 A	38	3	2 NO + 2 NC	101193	Ex9C25 22 3P 42V	1/20
36 V AC	25 A	38	3	2 NO + 2 NC	101194	Ex9C25 22 3P 36V	1/20
<b>24 V AC</b>	<b>25 A</b>	<b>38</b>	<b>3</b>	<b>2 NO + 2 NC</b>	<b>101195</b>	<b>Ex9C25 22 3P 24V</b>	<b>1/20</b>

### Wiring diagrams

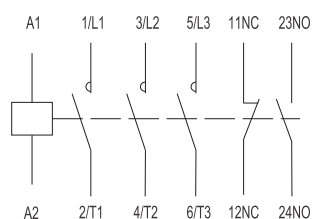

Ex9C25 11 3P

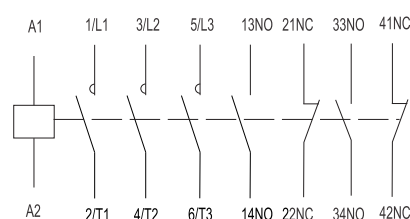

Ex9C25 22 3P

# Contactors Ex9C, frame size 38

## Rated current 32 A, 3-pole

- Standard version of contactor
- Mounting onto device (DIN) rail 35 mm or onto panel
- Front-mounted auxiliary contacts AX42.. as well as side-mounted ones AX43 can be used
- Can be combined with overload relays Ex9R38M



Control Voltage	$I_e$	Frame size	Poles	Auxiliary contacts	Article No.	Type	Packing
415 V AC	32 A	38	3	1 NO + 1 NC	101196	Ex9C32 11 3P 415V	1/20
400 V AC	32 A	38	3	1 NO + 1 NC	101197	Ex9C32 11 3P 400V	1/20
380 V AC	32 A	38	3	1 NO + 1 NC	101198	Ex9C32 11 3P 380V	1/20
240 V AC	32 A	38	3	1 NO + 1 NC	101199	Ex9C32 11 3P 240V	1/20
<b>230 V AC</b>	<b>32 A</b>	<b>38</b>	<b>3</b>	<b>1 NO + 1 NC</b>	<b>101200</b>	<b>Ex9C32 11 3P 230V</b>	<b>1/20</b>
220 V AC	32 A	38	3	1 NO + 1 NC	101201	Ex9C32 11 3P 220V	1/20
127 V AC	32 A	38	3	1 NO + 1 NC	101202	Ex9C32 11 3P 127V	1/20
110 V AC	32 A	38	3	1 NO + 1 NC	101203	Ex9C32 11 3P 110V	1/20
48 V AC	32 A	38	3	1 NO + 1 NC	101204	Ex9C32 11 3P 48V	1/20
42 V AC	32 A	38	3	1 NO + 1 NC	101205	Ex9C32 11 3P 42V	1/20
36 V AC	32 A	38	3	1 NO + 1 NC	101206	Ex9C32 11 3P 36V	1/20
<b>24 V AC</b>	<b>32 A</b>	<b>38</b>	<b>3</b>	<b>1 NO + 1 NC</b>	<b>101207</b>	<b>Ex9C32 11 3P 24V</b>	<b>1/20</b>
415 V AC	32 A	38	3	2 NO + 2 NC	101208	Ex9C32 22 3P 415V	1/20
400 V AC	32 A	38	3	2 NO + 2 NC	101209	Ex9C32 22 3P 400V	1/20
380 V AC	32 A	38	3	2 NO + 2 NC	101210	Ex9C32 22 3P 380V	1/20
240 V AC	32 A	38	3	2 NO + 2 NC	101211	Ex9C32 22 3P 240V	1/20
<b>230 V AC</b>	<b>32 A</b>	<b>38</b>	<b>3</b>	<b>2 NO + 2 NC</b>	<b>101212</b>	<b>Ex9C32 22 3P 230V</b>	<b>1/20</b>
220 V AC	32 A	38	3	2 NO + 2 NC	101213	Ex9C32 22 3P 220V	1/20
127 V AC	32 A	38	3	2 NO + 2 NC	101214	Ex9C32 22 3P 127V	1/20
110 V AC	32 A	38	3	2 NO + 2 NC	101215	Ex9C32 22 3P 110V	1/20
48 V AC	32 A	38	3	2 NO + 2 NC	101216	Ex9C32 22 3P 48V	1/20
42 V AC	32 A	38	3	2 NO + 2 NC	101217	Ex9C32 22 3P 42V	1/20
36 V AC	32 A	38	3	2 NO + 2 NC	101218	Ex9C32 22 3P 36V	1/20
<b>24 V AC</b>	<b>32 A</b>	<b>38</b>	<b>3</b>	<b>2 NO + 2 NC</b>	<b>101219</b>	<b>Ex9C32 22 3P 24V</b>	<b>1/20</b>

### Wiring diagrams

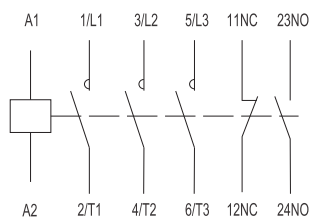

Ex9C32 11 3P

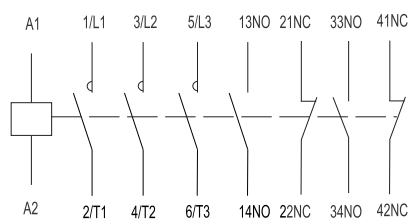

Ex9C32 22 3P

# Contactor Ex9C, frame size 38

## Rated current 38 A, 3-pole

- Standard version of contactor
- Mounting onto device (DIN) rail 35 mm or onto panel
- Front-mounted auxiliary contacts AX42.. as well as side-mounted ones AX43 can be used
- Can be combined with overload relays Ex9R38M



Control Voltage	$I_e$	Frame size	Poles	Auxiliary contacts	Article No.	Type	Packing
415 V AC	38 A	38	3	1 NO + 1 NC	101220	Ex9C38 11 3P 415V	1/20
400 V AC	38 A	38	3	1 NO + 1 NC	101221	Ex9C38 11 3P 400V	1/20
380 V AC	38 A	38	3	1 NO + 1 NC	101222	Ex9C38 11 3P 380V	1/20
240 V AC	38 A	38	3	1 NO + 1 NC	101223	Ex9C38 11 3P 240V	1/20
<b>230 V AC</b>	<b>38 A</b>	<b>38</b>	<b>3</b>	<b>1 NO + 1 NC</b>	<b>101224</b>	<b>Ex9C38 11 3P 230V</b>	<b>1/20</b>
220 V AC	38 A	38	3	1 NO + 1 NC	101225	Ex9C38 11 3P 220V	1/20
127 V AC	38 A	38	3	1 NO + 1 NC	101226	Ex9C38 11 3P 127V	1/20
110 V AC	38 A	38	3	1 NO + 1 NC	101227	Ex9C38 11 3P 110V	1/20
48 V AC	38 A	38	3	1 NO + 1 NC	101228	Ex9C38 11 3P 48V	1/20
42 V AC	38 A	38	3	1 NO + 1 NC	101229	Ex9C38 11 3P 42V	1/20
36 V AC	38 A	38	3	1 NO + 1 NC	101230	Ex9C38 11 3P 36V	1/20
<b>24 V AC</b>	<b>38 A</b>	<b>38</b>	<b>3</b>	<b>1 NO + 1 NC</b>	<b>101231</b>	<b>Ex9C38 11 3P 24V</b>	<b>1/20</b>
415 V AC	38 A	38	3	2 NO + 2 NC	101232	Ex9C38 22 3P 415V	1/20
400 V AC	38 A	38	3	2 NO + 2 NC	101233	Ex9C38 22 3P 400V	1/20
380 V AC	38 A	38	3	2 NO + 2 NC	101234	Ex9C38 22 3P 380V	1/20
240 V AC	38 A	38	3	2 NO + 2 NC	101235	Ex9C38 22 3P 240V	1/20
<b>230 V AC</b>	<b>38 A</b>	<b>38</b>	<b>3</b>	<b>2 NO + 2 NC</b>	<b>101236</b>	<b>Ex9C38 22 3P 230V</b>	<b>1/20</b>
220 V AC	38 A	38	3	2 NO + 2 NC	101237	Ex9C38 22 3P 220V	1/20
127 V AC	38 A	38	3	2 NO + 2 NC	101238	Ex9C38 22 3P 127V	1/20
110 V AC	38 A	38	3	2 NO + 2 NC	101239	Ex9C38 22 3P 110V	1/20
48 V AC	38 A	38	3	2 NO + 2 NC	101240	Ex9C38 22 3P 48V	1/20
42 V AC	38 A	38	3	2 NO + 2 NC	101241	Ex9C38 22 3P 42V	1/20
36 V AC	38 A	38	3	2 NO + 2 NC	101242	Ex9C38 22 3P 36V	1/20
<b>24 V AC</b>	<b>38 A</b>	<b>38</b>	<b>3</b>	<b>2 NO + 2 NC</b>	<b>101243</b>	<b>Ex9C38 22 3P 24V</b>	<b>1/20</b>

### Wiring diagrams

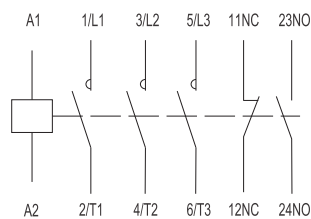

Ex9C38 11 3P

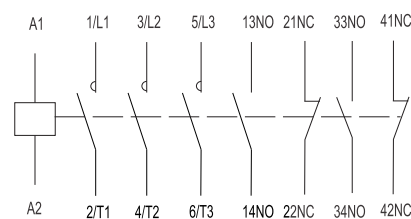

Ex9C38 22 3P

# Contactors Ex9C, frame size 65

## Rated current 40 A, 3-pole

- Standard version of contactor
- Mounting onto device (DIN) rail 35 mm and 75 mm or onto panel
- Front-mounted auxiliary contacts AX42.. as well as side-mounted ones AX43 can be used
- Can be combined with overload relays Ex9R100



Control Voltage	$I_e$	Frame size	Poles	Auxiliary contacts	Article No.	Type	Packing
415 V AC	40 A	65	3	1 NO + 1 NC	101244	Ex9C40 11 3P 415V	1/12
400 V AC	40 A	65	3	1 NO + 1 NC	101245	Ex9C40 11 3P 400V	1/12
380 V AC	40 A	65	3	1 NO + 1 NC	101246	Ex9C40 11 3P 380V	1/12
240 V AC	40 A	65	3	1 NO + 1 NC	101247	Ex9C40 11 3P 240V	1/12
<b>230 V AC</b>	<b>40 A</b>	<b>65</b>	<b>3</b>	<b>1 NO + 1 NC</b>	<b>101248</b>	<b>Ex9C40 11 3P 230V</b>	<b>1/12</b>
220 V AC	40 A	65	3	1 NO + 1 NC	101249	Ex9C40 11 3P 220V	1/12
127 V AC	40 A	65	3	1 NO + 1 NC	101250	Ex9C40 11 3P 127V	1/12
110 V AC	40 A	65	3	1 NO + 1 NC	101251	Ex9C40 11 3P 110V	1/12
48 V AC	40 A	65	3	1 NO + 1 NC	101252	Ex9C40 11 3P 48V	1/12
42 V AC	40 A	65	3	1 NO + 1 NC	101253	Ex9C40 11 3P 42V	1/12
36 V AC	40 A	65	3	1 NO + 1 NC	101254	Ex9C40 11 3P 36V	1/12
<b>24 V AC</b>	<b>40 A</b>	<b>65</b>	<b>3</b>	<b>1 NO + 1 NC</b>	<b>101255</b>	<b>Ex9C40 11 3P 24V</b>	<b>1/12</b>

## Rated current 50 A, 3-pole

- Standard version of contactor
- Mounting onto device (DIN) rail 35 mm and 75 mm or onto panel
- Front-mounted auxiliary contacts AX42.. as well as side-mounted ones AX43 can be used
- Can be combined with overload relays Ex9R100



Control Voltage	$I_e$	Frame size	Poles	Auxiliary contacts	Article No.	Type	Packing
415 V AC	50 A	65	3	1 NO + 1 NC	101256	Ex9C50 11 3P 415V	1/12
400 V AC	50 A	65	3	1 NO + 1 NC	101257	Ex9C50 11 3P 400V	1/12
380 V AC	50 A	65	3	1 NO + 1 NC	101258	Ex9C50 11 3P 380V	1/12
240 V AC	50 A	65	3	1 NO + 1 NC	101259	Ex9C50 11 3P 240V	1/12
<b>230 V AC</b>	<b>50 A</b>	<b>65</b>	<b>3</b>	<b>1 NO + 1 NC</b>	<b>101260</b>	<b>Ex9C50 11 3P 230V</b>	<b>1/12</b>
220 V AC	50 A	65	3	1 NO + 1 NC	101261	Ex9C50 11 3P 220V	1/12
127 V AC	50 A	65	3	1 NO + 1 NC	101262	Ex9C50 11 3P 127V	1/12
110 V AC	50 A	65	3	1 NO + 1 NC	101263	Ex9C50 11 3P 110V	1/12
48 V AC	50 A	65	3	1 NO + 1 NC	101264	Ex9C50 11 3P 48V	1/12
42 V AC	50 A	65	3	1 NO + 1 NC	101265	Ex9C50 11 3P 42V	1/12
36 V AC	50 A	65	3	1 NO + 1 NC	101266	Ex9C50 11 3P 36V	1/12
<b>24 V AC</b>	<b>50 A</b>	<b>65</b>	<b>3</b>	<b>1 NO + 1 NC</b>	<b>101267</b>	<b>Ex9C50 11 3P 24V</b>	<b>1/12</b>



# Contactors Ex9C, frame size 65

## Rated current 65 A, 3-pole

- Standard version of contactor
- Mounting onto device (DIN) rail 35 mm and 75 mm or onto panel
- Front-mounted auxiliary contacts AX42.. as well as side-mounted ones AX43 can be used
- Can be combined with overload relays Ex9R100



Control Voltage	$I_e$	Frame size	Poles	Auxiliary contacts	Article No.	Type	Packing
415 V AC	65 A	65	3	1 NO + 1 NC	101268	Ex9C65 11 3P 415V	1/12
400 V AC	65 A	65	3	1 NO + 1 NC	101269	Ex9C65 11 3P 400V	1/12
380 V AC	65 A	65	3	1 NO + 1 NC	101270	Ex9C65 11 3P 380V	1/12
240 V AC	65 A	65	3	1 NO + 1 NC	101271	Ex9C65 11 3P 240V	1/12
<b>230 V AC</b>	<b>65 A</b>	<b>65</b>	<b>3</b>	<b>1 NO + 1 NC</b>	<b>101272</b>	<b>Ex9C65 11 3P 230V</b>	<b>1/12</b>
220 V AC	65 A	65	3	1 NO + 1 NC	101273	Ex9C65 11 3P 220V	1/12
127 V AC	65 A	65	3	1 NO + 1 NC	101274	Ex9C65 11 3P 127V	1/12
110 V AC	65 A	65	3	1 NO + 1 NC	101275	Ex9C65 11 3P 110V	1/12
48 V AC	65 A	65	3	1 NO + 1 NC	101276	Ex9C65 11 3P 48V	1/12
42 V AC	65 A	65	3	1 NO + 1 NC	101277	Ex9C65 11 3P 42V	1/12
36 V AC	65 A	65	3	1 NO + 1 NC	101278	Ex9C65 11 3P 36V	1/12
<b>24 V AC</b>	<b>65 A</b>	<b>65</b>	<b>3</b>	<b>1 NO + 1 NC</b>	<b>101279</b>	<b>Ex9C65 11 3P 24V</b>	<b>1/12</b>

### Wiring diagram

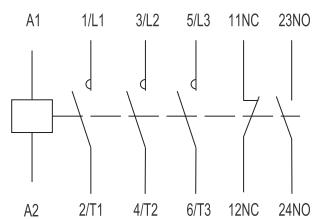

Ex9C40, Ex9C50, Ex9C65 11 3P

# Contactors Ex9C, frame size 100

## Rated current 80 A, 3-pole

- Standard version of contactor
- Mounting onto device (DIN) rail 35 mm and 75 mm or onto panel
- Front-mounted auxiliary contacts AX42.. as well as side-mounted ones AX43 can be used
- Can be combined with overload relays Ex9R100



Control Voltage	$I_e$	Frame size	Poles	Auxiliary contacts	Article No.	Type	Packing
415 V AC	80 A	100	3	1 NO + 1 NC	101335	Ex9C80 11 3P 415V	1/12
400 V AC	80 A	100	3	1 NO + 1 NC	101336	Ex9C80 11 3P 400V	1/12
380 V AC	80 A	100	3	1 NO + 1 NC	101337	Ex9C80 11 3P 380V	1/12
240 V AC	80 A	100	3	1 NO + 1 NC	101338	Ex9C80 11 3P 240V	1/12
<b>230 V AC</b>	<b>80 A</b>	<b>100</b>	<b>3</b>	<b>1 NO + 1 NC</b>	<b>101339</b>	<b>Ex9C80 11 3P 230V</b>	<b>1/12</b>
220 V AC	80 A	100	3	1 NO + 1 NC	101340	Ex9C80 11 3P 220V	1/12
127 V AC	80 A	100	3	1 NO + 1 NC	101341	Ex9C80 11 3P 127V	1/12
110 V AC	80 A	100	3	1 NO + 1 NC	101342	Ex9C80 11 3P 110V	1/12
48 V AC	80 A	100	3	1 NO + 1 NC	101343	Ex9C80 11 3P 48V	1/12
42 V AC	80 A	100	3	1 NO + 1 NC	101344	Ex9C80 11 3P 42V	1/12
36 V AC	80 A	100	3	1 NO + 1 NC	101345	Ex9C80 11 3P 36V	1/12
<b>24 V AC</b>	<b>80 A</b>	<b>100</b>	<b>3</b>	<b>1 NO + 1 NC</b>	<b>101346</b>	<b>Ex9C80 11 3P 24V</b>	<b>1/12</b>

## Rated current 100 A, 3-pole

- Standard version of contactor
- Mounting onto device (DIN) rail 35 mm and 75 mm or onto panel
- Front-mounted auxiliary contacts AX42.. as well as side-mounted ones AX43 can be used
- Can be combined with overload relays Ex9R100



Control Voltage	$I_e$	Frame size	Poles	Auxiliary contacts	Article No.	Type	Packing
415 V AC	100 A	100	3	1 NO + 1 NC	101347	Ex9C100 11 3P 415V	1/12
400 V AC	100 A	100	3	1 NO + 1 NC	101348	Ex9C100 11 3P 400V	1/12
380 V AC	100 A	100	3	1 NO + 1 NC	101349	Ex9C100 11 3P 380V	1/12
240 V AC	100 A	100	3	1 NO + 1 NC	101350	Ex9C100 11 3P 240V	1/12
<b>230 V AC</b>	<b>100 A</b>	<b>100</b>	<b>3</b>	<b>1 NO + 1 NC</b>	<b>101351</b>	<b>Ex9C100 11 3P 230V</b>	<b>1/12</b>
220 V AC	100 A	100	3	1 NO + 1 NC	101352	Ex9C100 11 3P 220V	1/12
127 V AC	100 A	100	3	1 NO + 1 NC	101353	Ex9C100 11 3P 127V	1/12
110 V AC	100 A	100	3	1 NO + 1 NC	101354	Ex9C100 11 3P 110V	1/12
48 V AC	100 A	100	3	1 NO + 1 NC	101355	Ex9C100 11 3P 48V	1/12
42 V AC	100 A	100	3	1 NO + 1 NC	101356	Ex9C100 11 3P 42V	1/12
36 V AC	100 A	100	3	1 NO + 1 NC	101357	Ex9C100 11 3P 36V	1/12
<b>24 V AC</b>	<b>100 A</b>	<b>100</b>	<b>3</b>	<b>1 NO + 1 NC</b>	<b>101358</b>	<b>Ex9C100 11 3P 24V</b>	<b>1/12</b>

### Wiring diagram

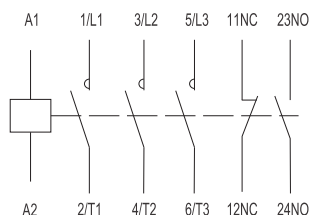

Ex9C80, Ex9C100 11 3P

# Reversible contactors Ex9CR



- Reversible combinations of contactors
- Tested according to IEC / EN 60947-4-1
- Four frame sizes with rated current up to 100 A at 400 V AC-3
- 3-pole versions
- Coil control voltage 24 — 415 V AC
- Rated conditional short circuit current  $I_q = 50 \text{ kA}$
- Mechanical interlock between contactors
- Mounting onto device rail (DIN) 35 or 75 mm or onto panel

Reversible contactors Ex9CR are intended mainly for switching of asynchronous motors with possibility of change of rotation direction. They can also be used for switching two circuits when it is necessary to ensure that maximum one circuit is connected.

The combinations are equipped with mechanical interlock. Additional electrical interlock of control voltages (e.g. for EN 60204) can be implemented by means of auxiliary contacts AX42 or built-in auxiliary contacts.

Splitting into four frame sizes brings optimization of electrical parameters and mechanical dimensions. All these frame sizes share full range of accessories. Overload relays Ex9R differ with the frame sizes in order to fit respective contactor of given rated current.

The same function can be achieved by the combination of two contactors Ex9C with mechanical interlock MIT4.

### Type Key

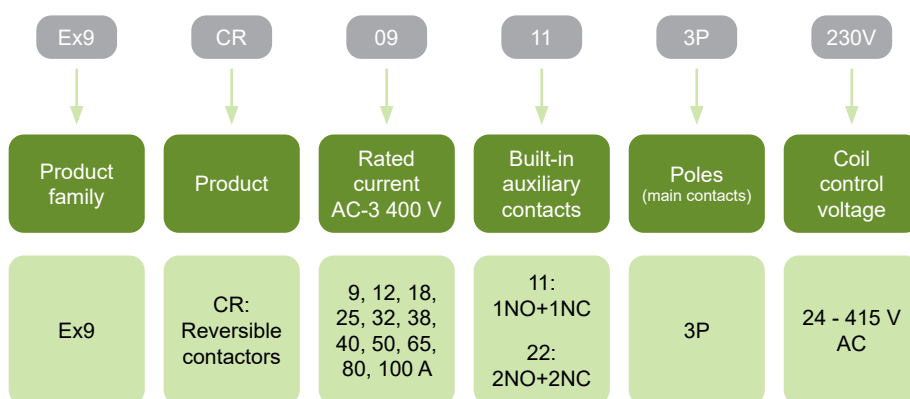

### Certification marks



# Reversible contactors Ex9CR

## Frame sizes



**Frame size 18**  
Rated currents 9, 12, 18 A



**Frame size 38**  
Rated currents 25, 32, 38 A



**Frame size 65**  
Rated currents 40, 50, 65 A



**Frame size 100**  
Rated currents 80, 100 A

# Reversible contactors Ex9CR

## Accessories

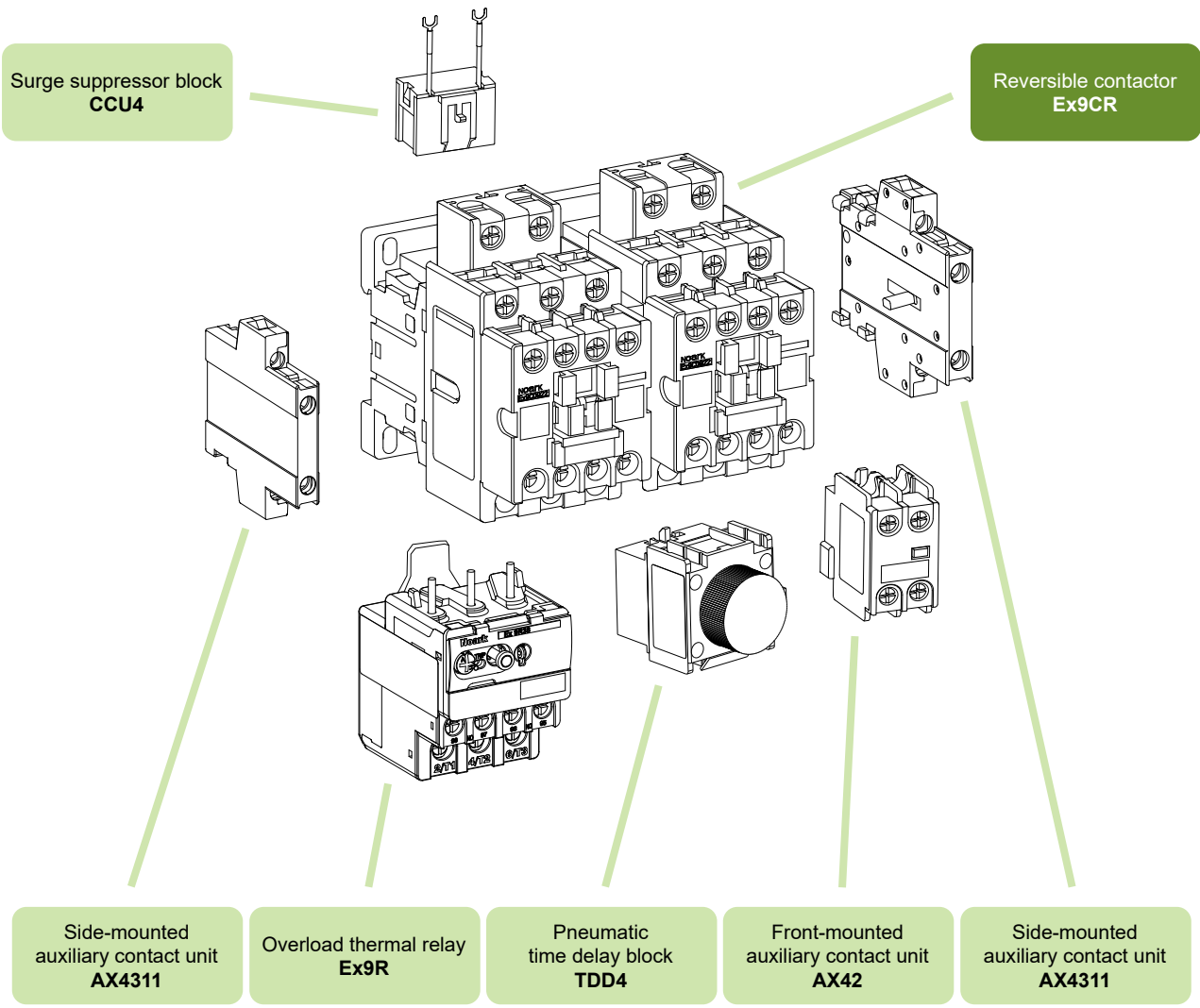

Auxiliary contacts AX4311	see page 104
Auxiliary contacts AX42	see page 104
Overload thermal relays Ex9R	see page 87
Pneumatic time delay block TDD4	see page 106
Surge suppressor block CCU4	see page 106

# Reversible contactors Ex9CR, frame size 18

## Rated current 9 A, 3-pole

- Reversible version of contactor
- Mounting onto device (DIN) rail 35 mm or onto panel
- Front-mounted auxiliary contacts AX42.. as well as side-mounted ones AX43 can be used
- Can be combined with overload relays Ex9R38M
- A given number of built-in auxiliary contacts belongs to single contactor unit in the pair



Control Voltage	AC-3 $I_e$	Frame size	Auxiliary contacts	Article No.	Type	Packing
415 V AC	9 A	18	1 NO + 1 NC	104662	Ex9CR09 11 3P 415V	1/40
400 V AC	9 A	18	1 NO + 1 NC	104663	Ex9CR09 11 3P 400V	1/40
380 V AC	9 A	18	1 NO + 1 NC	104664	Ex9CR09 11 3P 380V	1/40
240 V AC	9 A	18	1 NO + 1 NC	104667	Ex9CR09 11 3P 240V	1/40
<b>230 V AC</b>	<b>9 A</b>	<b>18</b>	<b>1 NO + 1 NC</b>	<b>104668</b>	<b>Ex9CR09 11 3P 230V</b>	<b>1/40</b>
220 V AC	9 A	18	1 NO + 1 NC	104669	Ex9CR09 11 3P 220V	1/40
127 V AC	9 A	18	1 NO + 1 NC	104670	Ex9CR09 11 3P 127V	1/40
110 V AC	9 A	18	1 NO + 1 NC	104671	Ex9CR09 11 3P 110V	1/40
48 V AC	9 A	18	1 NO + 1 NC	104660	Ex9CR09 11 3P 48V	1/40
42 V AC	9 A	18	1 NO + 1 NC	104661	Ex9CR09 11 3P 42V	1/40
36 V AC	9 A	18	1 NO + 1 NC	104665	Ex9CR09 11 3P 36V	1/40
<b>24 V AC</b>	<b>9 A</b>	<b>18</b>	<b>1 NO + 1 NC</b>	<b>104666</b>	<b>Ex9CR09 11 3P 24V</b>	<b>1/40</b>
415 V AC	9 A	18	2 NO + 2 NC	104650	Ex9CR09 22 3P 415V	1/40
400 V AC	9 A	18	2 NO + 2 NC	104651	Ex9CR09 22 3P 400V	1/40
380 V AC	9 A	18	2 NO + 2 NC	104652	Ex9CR09 22 3P 380V	1/40
240 V AC	9 A	18	2 NO + 2 NC	104655	Ex9CR09 22 3P 240V	1/40
<b>230 V AC</b>	<b>9 A</b>	<b>18</b>	<b>2 NO + 2 NC</b>	<b>104656</b>	<b>Ex9CR09 22 3P 230V</b>	<b>1/40</b>
220 V AC	9 A	18	2 NO + 2 NC	104657	Ex9CR09 22 3P 220V	1/40
127 V AC	9 A	18	2 NO + 2 NC	104658	Ex9CR09 22 3P 127V	1/40
110 V AC	9 A	18	2 NO + 2 NC	104659	Ex9CR09 22 3P 110V	1/40
48 V AC	9 A	18	2 NO + 2 NC	104648	Ex9CR09 22 3P 48V	1/40
42 V AC	9 A	18	2 NO + 2 NC	104649	Ex9CR09 22 3P 42V	1/40
36 V AC	9 A	18	2 NO + 2 NC	104653	Ex9CR09 22 3P 36V	1/40
<b>24 V AC</b>	<b>9 A</b>	<b>18</b>	<b>2 NO + 2 NC</b>	<b>104654</b>	<b>Ex9CR09 22 3P 24V</b>	<b>1/40</b>

### Wiring diagrams

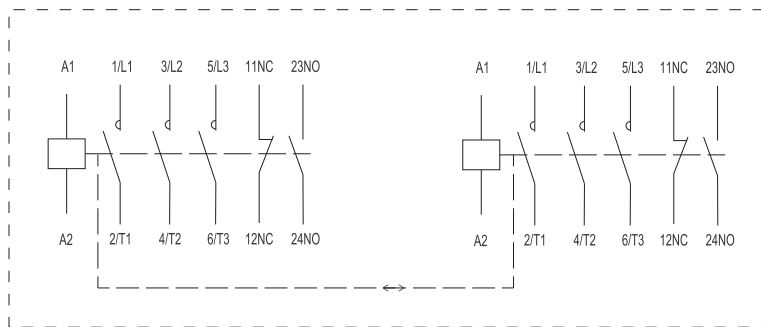

Ex9CR09 11 3P

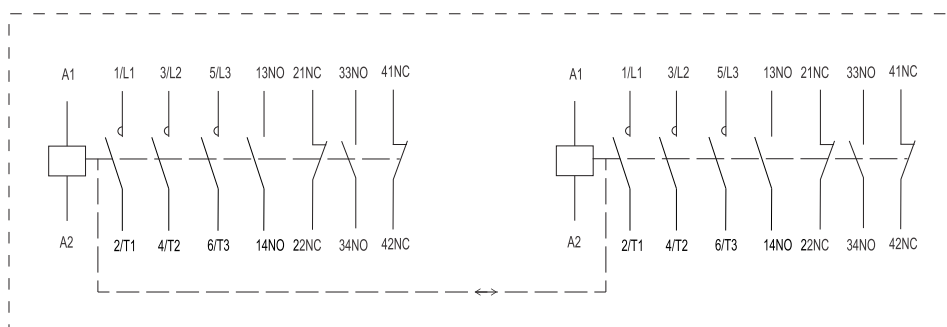

Ex9CR09 22 3P

# Reversible contactors Ex9CR, frame size 18

## Rated current 12 A, 3-pole

- Reversible version of contactor
- Mounting onto device (DIN) rail 35 mm or onto panel
- Front-mounted auxiliary contacts AX42.. as well as side-mounted ones AX43 can be used
- Can be combined with overload relays Ex9R38
- A given number of built-in auxiliary contacts belongs to single contactor unit in the pair



Control Voltage	AC-3 $I_e$	Frame size	Auxiliary contacts	Article No.	Type	Packing
415 V AC	12 A	18	1 NO + 1 NC	104686	Ex9CR12 11 3P 415V	1/40
400 V AC	12 A	18	1 NO + 1 NC	104687	Ex9CR12 11 3P 400V	1/40
380 V AC	12 A	18	1 NO + 1 NC	104688	Ex9CR12 11 3P 380V	1/40
240 V AC	12 A	18	1 NO + 1 NC	104691	Ex9CR12 11 3P 240V	1/40
<b>230 V AC</b>	<b>12 A</b>	<b>18</b>	<b>1 NO + 1 NC</b>	<b>104692</b>	<b>Ex9CR12 11 3P 230V</b>	<b>1/40</b>
220 V AC	12 A	18	1 NO + 1 NC	104693	Ex9CR12 11 3P 220V	1/40
127 V AC	12 A	18	1 NO + 1 NC	104694	Ex9CR12 11 3P 127V	1/40
110 V AC	12 A	18	1 NO + 1 NC	104695	Ex9CR12 11 3P 110V	1/40
48 V AC	12 A	18	1 NO + 1 NC	104684	Ex9CR12 11 3P 48V	1/40
42 V AC	12 A	18	1 NO + 1 NC	104685	Ex9CR12 11 3P 42V	1/40
36 V AC	12 A	18	1 NO + 1 NC	104689	Ex9CR12 11 3P 36V	1/40
<b>24 V AC</b>	<b>12 A</b>	<b>18</b>	<b>1 NO + 1 NC</b>	<b>104690</b>	<b>Ex9CR12 11 3P 24V</b>	<b>1/40</b>
415 V AC	12 A	18	2 NO + 2 NC	104674	Ex9CR12 22 3P 415V	1/40
400 V AC	12 A	18	2 NO + 2 NC	104675	Ex9CR12 22 3P 400V	1/40
380 V AC	12 A	18	2 NO + 2 NC	104676	Ex9CR12 22 3P 380V	1/40
240 V AC	12 A	18	2 NO + 2 NC	104679	Ex9CR12 22 3P 240V	1/40
<b>230 V AC</b>	<b>12 A</b>	<b>18</b>	<b>2 NO + 2 NC</b>	<b>104680</b>	<b>Ex9CR12 22 3P 230V</b>	<b>1/40</b>
220 V AC	12 A	18	2 NO + 2 NC	104681	Ex9CR12 22 3P 220V	1/40
127 V AC	12 A	18	2 NO + 2 NC	104682	Ex9CR12 22 3P 127V	1/40
110 V AC	12 A	18	2 NO + 2 NC	104683	Ex9CR12 22 3P 110V	1/40
48 V AC	12 A	18	2 NO + 2 NC	104672	Ex9CR12 22 3P 48V	1/40
42 V AC	12 A	18	2 NO + 2 NC	104673	Ex9CR12 22 3P 42V	1/40
36 V AC	12 A	18	2 NO + 2 NC	104677	Ex9CR12 22 3P 36V	1/40
<b>24 V AC</b>	<b>12 A</b>	<b>18</b>	<b>2 NO + 2 NC</b>	<b>104678</b>	<b>Ex9CR12 22 3P 24V</b>	<b>1/40</b>

### Wiring diagrams

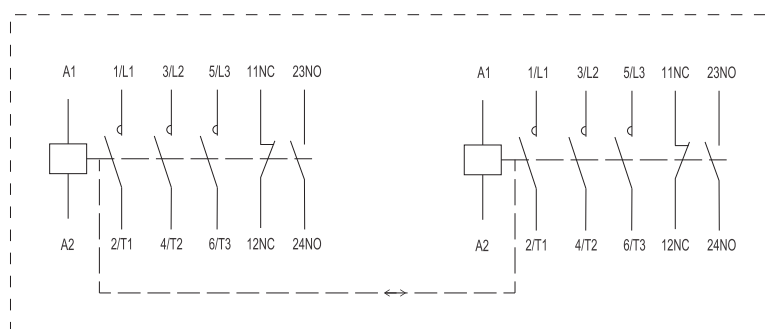

Ex9CR12 11 3P

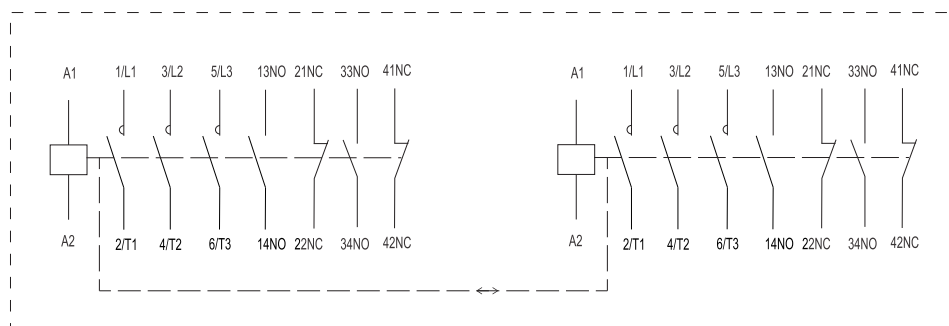

Ex9CR12 22 3P

# Reversible contactors Ex9CR, frame size 18

## Rated current 18 A, 3-pole

- Reversible version of contactor
- Mounting onto device (DIN) rail 35 mm or onto panel
- Front-mounted auxiliary contacts AX42.. as well as side-mounted ones AX43 can be used
- Can be combined with overload relays Ex9R38
- A given number of built-in auxiliary contacts belongs to single contactor unit in the pair



Control Voltage	AC-3 $I_e$	Frame size	Auxiliary contacts	Article No.	Type	Packing
415 V AC	18 A	18	1 NO + 1 NC	104710	Ex9CR18 11 3P 415V	1/40
400 V AC	18 A	18	1 NO + 1 NC	104711	Ex9CR18 11 3P 400V	1/40
380 V AC	18 A	18	1 NO + 1 NC	104712	Ex9CR18 11 3P 380V	1/40
240 V AC	18 A	18	1 NO + 1 NC	104715	Ex9CR18 11 3P 240V	1/40
<b>230 V AC</b>	<b>18 A</b>	<b>18</b>	<b>1 NO + 1 NC</b>	<b>104716</b>	<b>Ex9CR18 11 3P 230V</b>	<b>1/40</b>
220 V AC	18 A	18	1 NO + 1 NC	104717	Ex9CR18 11 3P 220V	1/40
127 V AC	18 A	18	1 NO + 1 NC	104718	Ex9CR18 11 3P 127V	1/40
110 V AC	18 A	18	1 NO + 1 NC	104719	Ex9CR18 11 3P 110V	1/40
48 V AC	18 A	18	1 NO + 1 NC	104708	Ex9CR18 11 3P 48V	1/40
42 V AC	18 A	18	1 NO + 1 NC	104709	Ex9CR18 11 3P 42V	1/40
36 V AC	18 A	18	1 NO + 1 NC	104713	Ex9CR18 11 3P 36V	1/40
<b>24 V AC</b>	<b>18 A</b>	<b>18</b>	<b>1 NO + 1 NC</b>	<b>104714</b>	<b>Ex9CR18 11 3P 24V</b>	<b>1/40</b>
415 V AC	18 A	18	2 NO + 2 NC	104698	Ex9CR18 22 3P 415V	1/40
400 V AC	18 A	18	2 NO + 2 NC	104699	Ex9CR18 22 3P 400V	1/40
380 V AC	18 A	18	2 NO + 2 NC	104700	Ex9CR18 22 3P 380V	1/40
240 V AC	18 A	18	2 NO + 2 NC	104703	Ex9CR18 22 3P 240V	1/40
<b>230 V AC</b>	<b>18 A</b>	<b>18</b>	<b>2 NO + 2 NC</b>	<b>104704</b>	<b>Ex9CR18 22 3P 230V</b>	<b>1/40</b>
220 V AC	18 A	18	2 NO + 2 NC	104705	Ex9CR18 22 3P 220V	1/40
127 V AC	18 A	18	2 NO + 2 NC	104706	Ex9CR18 22 3P 127V	1/40
110 V AC	18 A	18	2 NO + 2 NC	104707	Ex9CR18 22 3P 110V	1/40
48 V AC	18 A	18	2 NO + 2 NC	104696	Ex9CR18 22 3P 48V	1/40
42 V AC	18 A	18	2 NO + 2 NC	104697	Ex9CR18 22 3P 42V	1/40
36 V AC	18 A	18	2 NO + 2 NC	104701	Ex9CR18 22 3P 36V	1/40
<b>24 V AC</b>	<b>18 A</b>	<b>18</b>	<b>2 NO + 2 NC</b>	<b>104702</b>	<b>Ex9CR18 22 3P 24V</b>	<b>1/40</b>

### Wiring diagrams

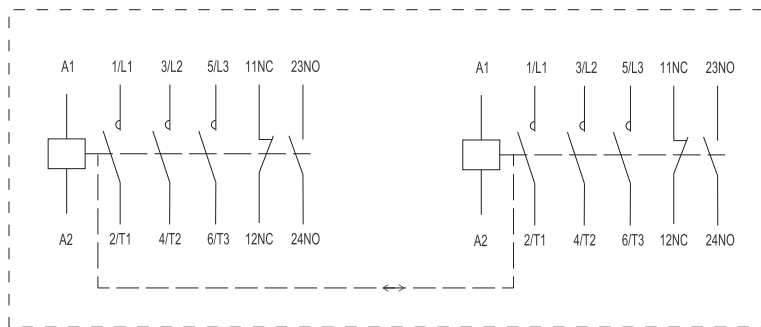

Ex9CR18 11 3P

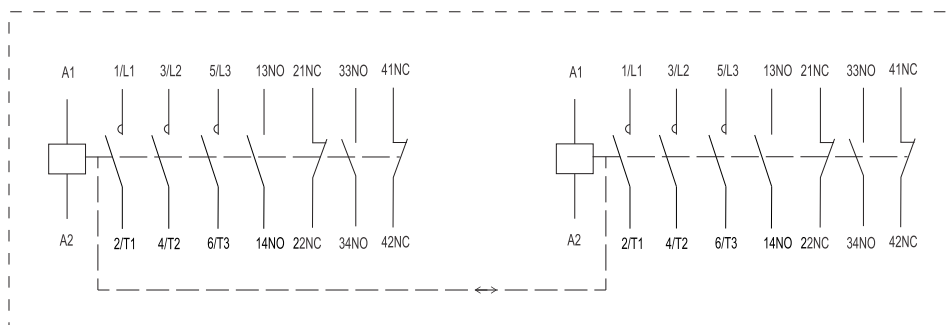

Ex9CR18 22 3P



# Reversible contactors Ex9CR, frame size 38

## Rated current 25 A, 3-pole

- Reversible version of contactor
- Mounting onto device (DIN) rail 35 mm or onto panel
- Front-mounted auxiliary contacts AX42.. as well as side-mounted ones AX43 can be used
- Can be combined with overload relays Ex9R38
- A given number of built-in auxiliary contacts belongs to single contactor unit in the pair



Control Voltage	AC-3 I <sub>e</sub>	Frame size	Auxiliary contacts	Article No.	Type	Packing
415 V AC	25 A	38	1 NO + 1 NC	104734	Ex9CR25 11 3P 415V	1/20
400 V AC	25 A	38	1 NO + 1 NC	104735	Ex9CR25 11 3P 400V	1/20
380 V AC	25 A	38	1 NO + 1 NC	104736	Ex9CR25 11 3P 380V	1/20
240 V AC	25 A	38	1 NO + 1 NC	104739	Ex9CR25 11 3P 240V	1/20
<b>230 V AC</b>	<b>25 A</b>	<b>38</b>	<b>1 NO + 1 NC</b>	<b>104740</b>	<b>Ex9CR25 11 3P 230V</b>	<b>1/20</b>
220 V AC	25 A	38	1 NO + 1 NC	104741	Ex9CR25 11 3P 220V	1/20
127 V AC	25 A	38	1 NO + 1 NC	104742	Ex9CR25 11 3P 127V	1/20
110 V AC	25 A	38	1 NO + 1 NC	104743	Ex9CR25 11 3P 110V	1/20
48 V AC	25 A	38	1 NO + 1 NC	104732	Ex9CR25 11 3P 48V	1/20
42 V AC	25 A	38	1 NO + 1 NC	104733	Ex9CR25 11 3P 42V	1/20
36 V AC	25 A	38	1 NO + 1 NC	104737	Ex9CR25 11 3P 36V	1/20
<b>24 V AC</b>	<b>25 A</b>	<b>38</b>	<b>1 NO + 1 NC</b>	<b>104738</b>	<b>Ex9CR25 11 3P 24V</b>	<b>1/20</b>
415 V AC	25 A	38	2 NO + 2 NC	104722	Ex9CR25 22 3P 415V	1/20
400 V AC	25 A	38	2 NO + 2 NC	104723	Ex9CR25 22 3P 400V	1/20
380 V AC	25 A	38	2 NO + 2 NC	104724	Ex9CR25 22 3P 380V	1/20
240 V AC	25 A	38	2 NO + 2 NC	104727	Ex9CR25 22 3P 240V	1/20
<b>230 V AC</b>	<b>25 A</b>	<b>38</b>	<b>2 NO + 2 NC</b>	<b>104728</b>	<b>Ex9CR25 22 3P 230V</b>	<b>1/20</b>
220 V AC	25 A	38	2 NO + 2 NC	104729	Ex9CR25 22 3P 220V	1/20
127 V AC	25 A	38	2 NO + 2 NC	104730	Ex9CR25 22 3P 127V	1/20
110 V AC	25 A	38	2 NO + 2 NC	104731	Ex9CR25 22 3P 110V	1/20
48 V AC	25 A	38	2 NO + 2 NC	104720	Ex9CR25 22 3P 48V	1/20
42 V AC	25 A	38	2 NO + 2 NC	104721	Ex9CR25 22 3P 42V	1/20
36 V AC	25 A	38	2 NO + 2 NC	104725	Ex9CR25 22 3P 36V	1/20
<b>24 V AC</b>	<b>25 A</b>	<b>38</b>	<b>2 NO + 2 NC</b>	<b>104726</b>	<b>Ex9CR25 22 3P 24V</b>	<b>1/20</b>

### Wiring diagrams

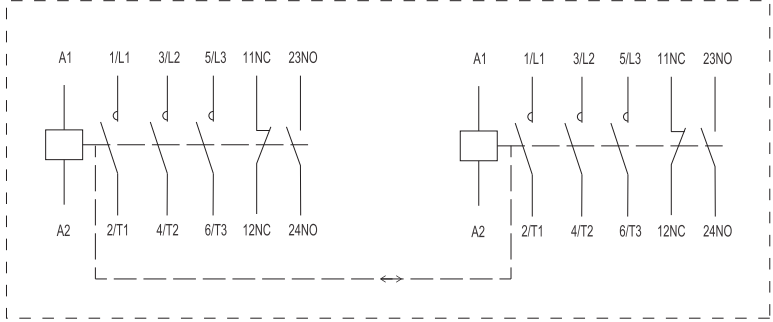

Ex9CR25 11 3P

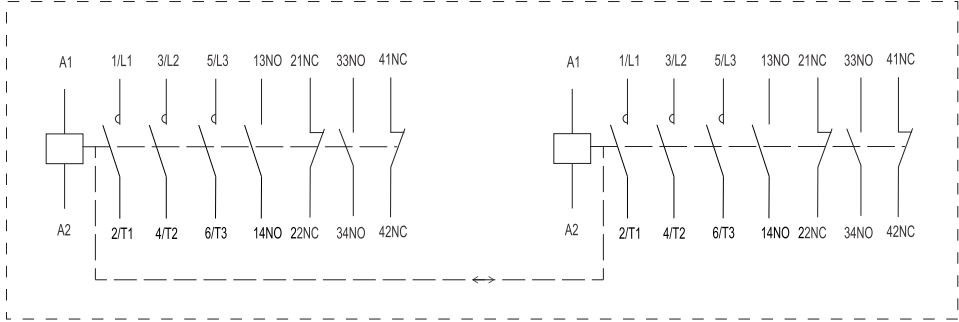

Ex9CR25 22 3P

# Reversible contactors Ex9CR, frame size 38

## Rated current 32 A, 3-pole

- Reversible version of contactor
- Mounting onto device (DIN) rail 35 mm or onto panel
- Front-mounted auxiliary contacts AX42.. as well as side-mounted ones AX43 can be used
- Can be combined with overload relays Ex9R38
- A given number of built-in auxiliary contacts belongs to single contactor unit in the pair

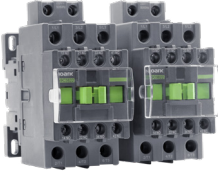

Control Voltage	AC-3 $I_e$	Frame size	Auxiliary contacts	Article No.	Type	Packing
415 V AC	32 A	38	1 NO + 1 NC	104758	Ex9CR32 11 3P 415V	1/20
400 V AC	32 A	38	1 NO + 1 NC	104759	Ex9CR32 11 3P 400V	1/20
380 V AC	32 A	38	1 NO + 1 NC	104760	Ex9CR32 11 3P 380V	1/20
240 V AC	32 A	38	1 NO + 1 NC	104763	Ex9CR32 11 3P 240V	1/20
<b>230 V AC</b>	<b>32 A</b>	<b>38</b>	<b>1 NO + 1 NC</b>	<b>104764</b>	<b>Ex9CR32 11 3P 230V</b>	<b>1/20</b>
220 V AC	32 A	38	1 NO + 1 NC	104765	Ex9CR32 11 3P 220V	1/20
127 V AC	32 A	38	1 NO + 1 NC	104766	Ex9CR32 11 3P 127V	1/20
110 V AC	32 A	38	1 NO + 1 NC	104767	Ex9CR32 11 3P 110V	1/20
48 V AC	32 A	38	1 NO + 1 NC	104756	Ex9CR32 11 3P 48V	1/20
42 V AC	32 A	38	1 NO + 1 NC	104757	Ex9CR32 11 3P 42V	1/20
36 V AC	32 A	38	1 NO + 1 NC	104761	Ex9CR32 11 3P 36V	1/20
<b>24 V AC</b>	<b>32 A</b>	<b>38</b>	<b>1 NO + 1 NC</b>	<b>104762</b>	<b>Ex9CR32 11 3P 24V</b>	<b>1/20</b>
415 V AC	32 A	38	2 NO + 2 NC	104746	Ex9CR32 22 3P 415V	1/20
400 V AC	32 A	38	2 NO + 2 NC	104747	Ex9CR32 22 3P 400V	1/20
380 V AC	32 A	38	2 NO + 2 NC	104748	Ex9CR32 22 3P 380V	1/20
240 V AC	32 A	38	2 NO + 2 NC	104751	Ex9CR32 22 3P 240V	1/20
<b>230 V AC</b>	<b>32 A</b>	<b>38</b>	<b>2 NO + 2 NC</b>	<b>104752</b>	<b>Ex9CR32 22 3P 230V</b>	<b>1/20</b>
220 V AC	32 A	38	2 NO + 2 NC	104753	Ex9CR32 22 3P 220V	1/20
127 V AC	32 A	38	2 NO + 2 NC	104754	Ex9CR32 22 3P 127V	1/20
110 V AC	32 A	38	2 NO + 2 NC	104755	Ex9CR32 22 3P 110V	1/20
48 V AC	32 A	38	2 NO + 2 NC	104744	Ex9CR32 22 3P 48V	1/20
42 V AC	32 A	38	2 NO + 2 NC	104745	Ex9CR32 22 3P 42V	1/20
36 V AC	32 A	38	2 NO + 2 NC	104749	Ex9CR32 22 3P 36V	1/20
<b>24 V AC</b>	<b>32 A</b>	<b>38</b>	<b>2 NO + 2 NC</b>	<b>104750</b>	<b>Ex9CR32 22 3P 24V</b>	<b>1/20</b>

### Wiring diagrams

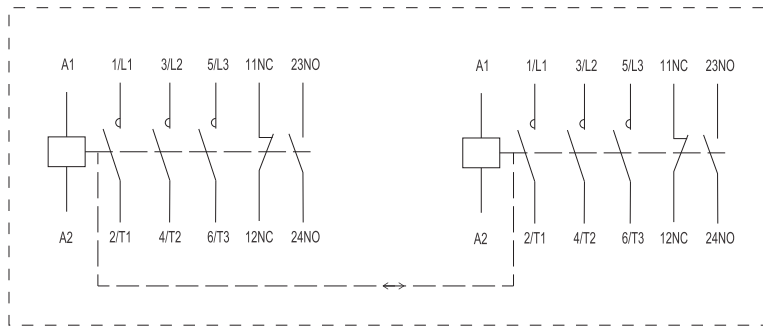

Ex9CR32 11 3P

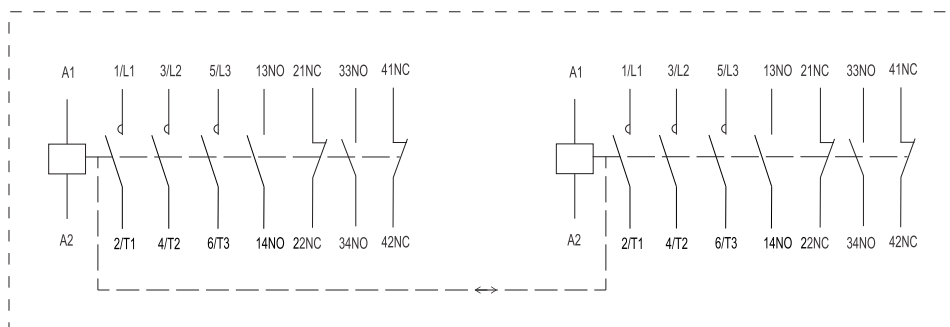

Ex9CR32 22 3P

# Reversible contactors Ex9CR, frame size 38

## Rated current 38 A, 3-pole

- Reversible version of contactor
- Mounting onto device (DIN) rail 35 mm or onto panel
- Front-mounted auxiliary contacts AX42.. as well as side-mounted ones AX43 can be used
- Can be combined with overload relays Ex9R38
- A given number of built-in auxiliary contacts belongs to single contactor unit in the pair



Control Voltage	AC-3 $I_e$	Frame size	Auxiliary contacts	Article No.	Type	Packing
415 V AC	38 A	38	1 NO + 1 NC	104782	Ex9CR38 11 3P 415V	1/20
400 V AC	38 A	38	1 NO + 1 NC	104783	Ex9CR38 11 3P 400V	1/20
380 V AC	38 A	38	1 NO + 1 NC	104784	Ex9CR38 11 3P 380V	1/20
240 V AC	38 A	38	1 NO + 1 NC	104787	Ex9CR38 11 3P 240V	1/20
<b>230 V AC</b>	<b>38 A</b>	<b>38</b>	<b>1 NO + 1 NC</b>	<b>104788</b>	<b>Ex9CR38 11 3P 230V</b>	<b>1/20</b>
220 V AC	38 A	38	1 NO + 1 NC	104789	Ex9CR38 11 3P 220V	1/20
127 V AC	38 A	38	1 NO + 1 NC	104790	Ex9CR38 11 3P 127V	1/20
110 V AC	38 A	38	1 NO + 1 NC	104791	Ex9CR38 11 3P 110V	1/20
48 V AC	38 A	38	1 NO + 1 NC	104780	Ex9CR38 11 3P 48V	1/20
42 V AC	38 A	38	1 NO + 1 NC	104781	Ex9CR38 11 3P 42V	1/20
36 V AC	38 A	38	1 NO + 1 NC	104785	Ex9CR38 11 3P 36V	1/20
<b>24 V AC</b>	<b>38 A</b>	<b>38</b>	<b>1 NO + 1 NC</b>	<b>104786</b>	<b>Ex9CR38 11 3P 24V</b>	<b>1/20</b>
415 V AC	38 A	38	2 NO + 2 NC	104770	Ex9CR38 22 3P 415V	1/20
400 V AC	38 A	38	2 NO + 2 NC	104771	Ex9CR38 22 3P 400V	1/20
380 V AC	38 A	38	2 NO + 2 NC	104772	Ex9CR38 22 3P 380V	1/20
240 V AC	38 A	38	2 NO + 2 NC	104775	Ex9CR38 22 3P 240V	1/20
<b>230 V AC</b>	<b>38 A</b>	<b>38</b>	<b>2 NO + 2 NC</b>	<b>104776</b>	<b>Ex9CR38 22 3P 230V</b>	<b>1/20</b>
220 V AC	38 A	38	2 NO + 2 NC	104777	Ex9CR38 22 3P 220V	1/20
127 V AC	38 A	38	2 NO + 2 NC	104778	Ex9CR38 22 3P 127V	1/20
110 V AC	38 A	38	2 NO + 2 NC	104779	Ex9CR38 22 3P 110V	1/20
48 V AC	38 A	38	2 NO + 2 NC	104768	Ex9CR38 22 3P 48V	1/20
42 V AC	38 A	38	2 NO + 2 NC	104769	Ex9CR38 22 3P 42V	1/20
36 V AC	38 A	38	2 NO + 2 NC	104773	Ex9CR38 22 3P 36V	1/20
<b>24 V AC</b>	<b>38 A</b>	<b>38</b>	<b>2 NO + 2 NC</b>	<b>104774</b>	<b>Ex9CR38 22 3P 24V</b>	<b>1/20</b>

### Wiring diagrams

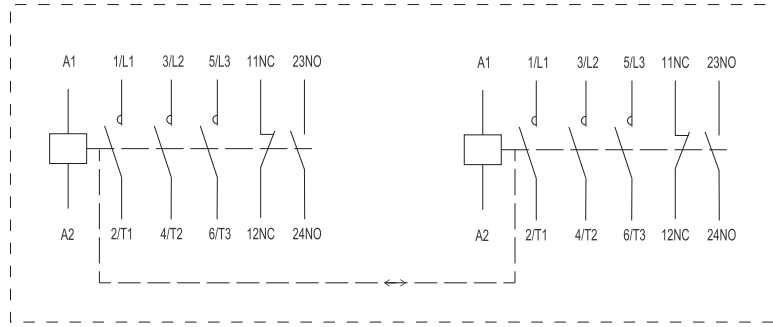

Ex9CR38 11 3P

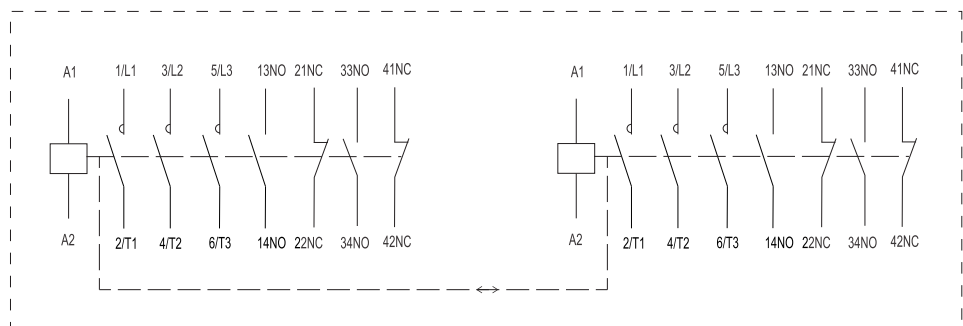

Ex9CR38 22 3P

# Reversible contactors Ex9CR, frame size 65

## Rated current 40 A, 3-pole

- Reversible version of contactor
- Mounting onto device (DIN) rail 35 mm and 75 mm or onto panel
- Front-mounted auxiliary contacts AX42.. as well as side-mounted ones AX43 can be used
- Can be combined with overload relays Ex9R100
- A given number of built-in auxiliary contacts belongs to single contactor unit in the pair



Control Voltage	AC-3 $I_e$	Frame size	Auxiliary contacts	Article No.	Type	Packing
415 V AC	40 A	65	1 NO + 1 NC	104794	Ex9CR40 11 3P 415V	1/12
400 V AC	40 A	65	1 NO + 1 NC	104795	Ex9CR40 11 3P 400V	1/12
380 V AC	40 A	65	1 NO + 1 NC	104796	Ex9CR40 11 3P 380V	1/12
240 V AC	40 A	65	1 NO + 1 NC	104799	Ex9CR40 11 3P 240V	1/12
<b>230 V AC</b>	<b>40 A</b>	<b>65</b>	<b>1 NO + 1 NC</b>	<b>104800</b>	<b>Ex9CR40 11 3P 230V</b>	<b>1/12</b>
220 V AC	40 A	65	1 NO + 1 NC	104801	Ex9CR40 11 3P 220V	1/12
127 V AC	40 A	65	1 NO + 1 NC	104802	Ex9CR40 11 3P 127V	1/12
110 V AC	40 A	65	1 NO + 1 NC	104803	Ex9CR40 11 3P 110V	1/12
48 V AC	40 A	65	1 NO + 1 NC	104792	Ex9CR40 11 3P 48V	1/12
42 V AC	40 A	65	1 NO + 1 NC	104793	Ex9CR40 11 3P 42V	1/12
36 V AC	40 A	65	1 NO + 1 NC	104797	Ex9CR40 11 3P 36V	1/12
<b>24 V AC</b>	<b>40 A</b>	<b>65</b>	<b>1 NO + 1 NC</b>	<b>104798</b>	<b>Ex9CR40 11 3P 24V</b>	<b>1/12</b>

### Wiring diagram

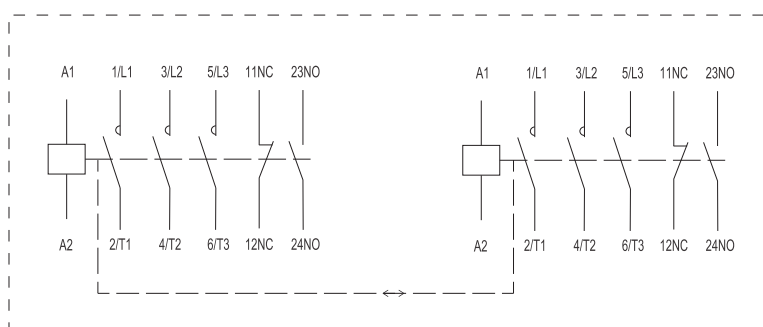

Ex9CR40 11 3P

# Reversible contactors Ex9CR, frame size 65

## Rated current 50 A, 3-pole

- Reversible version of contactor
- Mounting onto device (DIN) rail 35 mm and 75 mm or onto panel
- Front-mounted auxiliary contacts AX42.. as well as side-mounted ones AX43 can be used
- Can be combined with overload relays Ex9R100
- A given number of built-in auxiliary contacts belongs to single contactor unit in the pair



Control Voltage	AC-3 $I_e$	Frame size	Auxiliary contacts	Article No.	Type	Packing
415 V AC	50 A	65	1 NO + 1 NC	104806	Ex9CR50 11 3P 415V	1/12
400 V AC	50 A	65	1 NO + 1 NC	104807	Ex9CR50 11 3P 400V	1/12
380 V AC	50 A	65	1 NO + 1 NC	104808	Ex9CR50 11 3P 380V	1/12
240 V AC	50 A	65	1 NO + 1 NC	104811	Ex9CR50 11 3P 240V	1/12
<b>230 V AC</b>	<b>50 A</b>	<b>65</b>	<b>1 NO + 1 NC</b>	<b>104812</b>	<b>Ex9CR50 11 3P 230V</b>	<b>1/12</b>
220 V AC	50 A	65	1 NO + 1 NC	104813	Ex9CR50 11 3P 220V	1/12
127 V AC	50 A	65	1 NO + 1 NC	104814	Ex9CR50 11 3P 127V	1/12
110 V AC	50 A	65	1 NO + 1 NC	104815	Ex9CR50 11 3P 110V	1/12
48 V AC	50 A	65	1 NO + 1 NC	104804	Ex9CR50 11 3P 48V	1/12
42 V AC	50 A	65	1 NO + 1 NC	104805	Ex9CR50 11 3P 42V	1/12
36 V AC	50 A	65	1 NO + 1 NC	104809	Ex9CR50 11 3P 36V	1/12
<b>24 V AC</b>	<b>50 A</b>	<b>65</b>	<b>1 NO + 1 NC</b>	<b>104810</b>	<b>Ex9CR50 11 3P 24V</b>	<b>1/12</b>

*Wiring diagram*

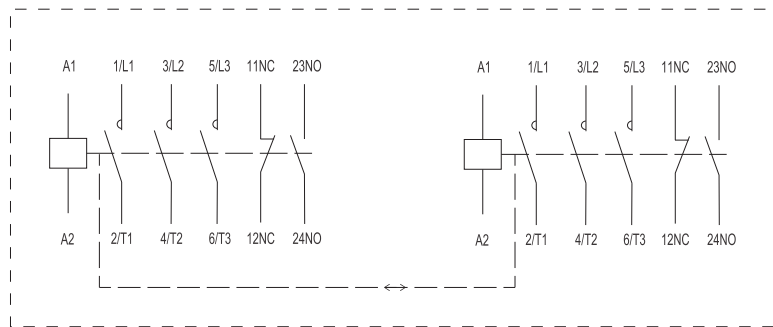

Ex9CR50 11 3P

# Reversible contactors Ex9CR, frame size 65

## Rated current 65 A, 3-pole

- Reversible version of contactor
- Mounting onto device (DIN) rail 35 mm and 75 mm or onto panel
- Front-mounted auxiliary contacts AX42.. as well as side-mounted ones AX43 can be used
- Can be combined with overload relays Ex9R100
- A given number of built-in auxiliary contacts belongs to single contactor unit in the pair



Control Voltage	AC-3 $I_e$	Frame size	Auxiliary contacts	Article No.	Type	Packing
415 V AC	65 A	65	1 NO + 1 NC	104818	Ex9CR65 11 3P 415V	1/12
400 V AC	65 A	65	1 NO + 1 NC	104819	Ex9CR65 11 3P 400V	1/12
380 V AC	65 A	65	1 NO + 1 NC	104820	Ex9CR65 11 3P 380V	1/12
240 V AC	65 A	65	1 NO + 1 NC	104823	Ex9CR65 11 3P 240V	1/12
<b>230 V AC</b>	<b>65 A</b>	<b>65</b>	<b>1 NO + 1 NC</b>	<b>104824</b>	<b>Ex9CR65 11 3P 230V</b>	<b>1/12</b>
220 V AC	65 A	65	1 NO + 1 NC	104825	Ex9CR65 11 3P 220V	1/12
127 V AC	65 A	65	1 NO + 1 NC	104826	Ex9CR65 11 3P 127V	1/12
110 V AC	65 A	65	1 NO + 1 NC	104827	Ex9CR65 11 3P 110V	1/12
48 V AC	65 A	65	1 NO + 1 NC	104816	Ex9CR65 11 3P 48V	1/12
42 V AC	65 A	65	1 NO + 1 NC	104817	Ex9CR65 11 3P 42V	1/12
36 V AC	65 A	65	1 NO + 1 NC	104821	Ex9CR65 11 3P 36V	1/12
<b>24 V AC</b>	<b>65 A</b>	<b>65</b>	<b>1 NO + 1 NC</b>	<b>104822</b>	<b>Ex9CR65 11 3P 24V</b>	<b>1/12</b>

### Wiring diagram

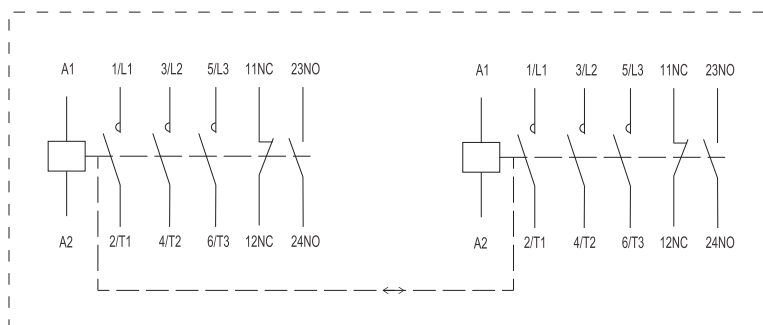

Ex9CR65 11 3P

# Reversible contactors Ex9CR, frame size 100

## Rated current 80 A, 3-pole

- Reversible version of contactor
- Mounting onto device (DIN) rail 35 mm and 75 mm or onto panel
- Front-mounted auxiliary contacts AX42.. as well as side-mounted ones AX43 can be used
- Can be combined with overload relays Ex9R100
- A given number of built-in auxiliary contacts belongs to single contactor unit in the pair



Control Voltage	AC-3 $I_e$	Frame size	Auxiliary contacts	Article No.	Type	Packing
415 V AC	80 A	100	1 NO + 1 NC	104830	Ex9CR80 11 3P 415V	1/12
400 V AC	80 A	100	1 NO + 1 NC	104831	Ex9CR80 11 3P 400V	1/12
380 V AC	80 A	100	1 NO + 1 NC	104832	Ex9CR80 11 3P 380V	1/12
240 V AC	80 A	100	1 NO + 1 NC	104835	Ex9CR80 11 3P 240V	1/12
<b>230 V AC</b>	<b>80 A</b>	<b>100</b>	<b>1 NO + 1 NC</b>	<b>104836</b>	<b>Ex9CR80 11 3P 230V</b>	<b>1/12</b>
220 V AC	80 A	100	1 NO + 1 NC	104837	Ex9CR80 11 3P 220V	1/12
127 V AC	80 A	100	1 NO + 1 NC	104838	Ex9CR80 11 3P 127V	1/12
110 V AC	80 A	100	1 NO + 1 NC	104839	Ex9CR80 11 3P 110V	1/12
48 V AC	80 A	100	1 NO + 1 NC	104828	Ex9CR80 11 3P 48V	1/12
42 V AC	80 A	100	1 NO + 1 NC	104829	Ex9CR80 11 3P 42V	1/12
36 V AC	80 A	100	1 NO + 1 NC	104833	Ex9CR80 11 3P 36V	1/12
<b>24 V AC</b>	<b>80 A</b>	<b>100</b>	<b>1 NO + 1 NC</b>	<b>104834</b>	<b>Ex9CR80 11 3P 24V</b>	<b>1/12</b>

*Wiring diagram*

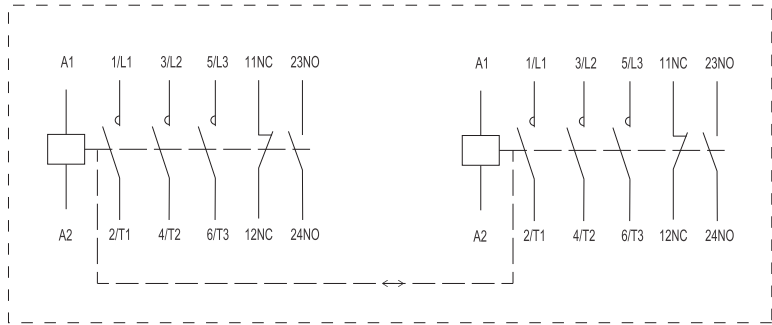

Ex9CR80 11 3P

# Reversible contactors Ex9CR, frame size 100

## Rated current 100 A, 3-pole

- Reversible version of contactor
- Mounting onto device (DIN) rail 35 mm and 75 mm or onto panel
- Front-mounted auxiliary contacts AX42.. as well as side-mounted ones AX43 can be used
- Can be combined with overload relays Ex9R100
- A given number of built-in auxiliary contacts belongs to single contactor unit in the pair



Control Voltage	AC-3 $I_e$	Frame size	Auxiliary contacts	Article No.	Type	Packing
415 V AC	100 A	100	1 NO + 1 NC	104842	Ex9CR100 11 3P 415V	1/12
400 V AC	100 A	100	1 NO + 1 NC	104843	Ex9CR100 11 3P 400V	1/12
380 V AC	100 A	100	1 NO + 1 NC	104844	Ex9CR100 11 3P 380V	1/12
240 V AC	100 A	100	1 NO + 1 NC	104847	Ex9CR100 11 3P 240V	1/12
<b>230 V AC</b>	<b>100 A</b>	<b>100</b>	<b>1 NO + 1 NC</b>	<b>104848</b>	<b>Ex9CR100 11 3P 230V</b>	<b>1/12</b>
220 V AC	100 A	100	1 NO + 1 NC	104849	Ex9CR100 11 3P 220V	1/12
127 V AC	100 A	100	1 NO + 1 NC	104850	Ex9CR100 11 3P 127V	1/12
110 V AC	100 A	100	1 NO + 1 NC	104851	Ex9CR100 11 3P 110V	1/12
48 V AC	100 A	100	1 NO + 1 NC	104840	Ex9CR100 11 3P 48V	1/12
42 V AC	100 A	100	1 NO + 1 NC	104841	Ex9CR100 11 3P 42V	1/12
36 V AC	100 A	100	1 NO + 1 NC	104845	Ex9CR100 11 3P 36V	1/12
<b>24 V AC</b>	<b>100 A</b>	<b>100</b>	<b>1 NO + 1 NC</b>	<b>104846</b>	<b>Ex9CR100 11 3P 24V</b>	<b>1/12</b>

### Wiring diagram

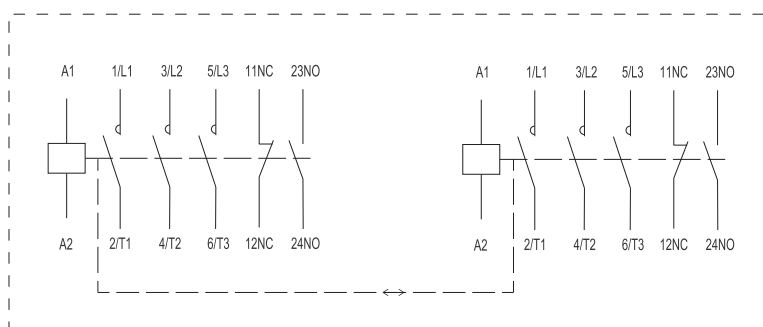

Ex9CR100 11 3P



# Contactors Ex9C up to 500 A



- Contactors according to IEC / EN 60947-4-1
- Rated current 115 - 500 A at 400 V AC-3
- 3-pole versions
- Coil control voltage 24 — 415 V AC/DC
- Rated conditional short circuit current  $I_q = 50 \text{ kA}$
- Suitable for industrial applications
- Mounting onto panel with screws

Ex9C contactors for rated current 115 - 500 A in category AC-3 are intended for various industrial applications including the heavy industrial ones. Splitting into next three frame sizes brings optimization of electrical parameters and mechanical dimensions. All these frame sizes share accessory auxiliary contacts.

The contactors are equipped with controlled coil. It ensures that power consumption is significantly reduced when contactor is closed.

Overload relays Ex9R differ with the frame sizes in order to fit respective contactor of given rated current.

## Type Key

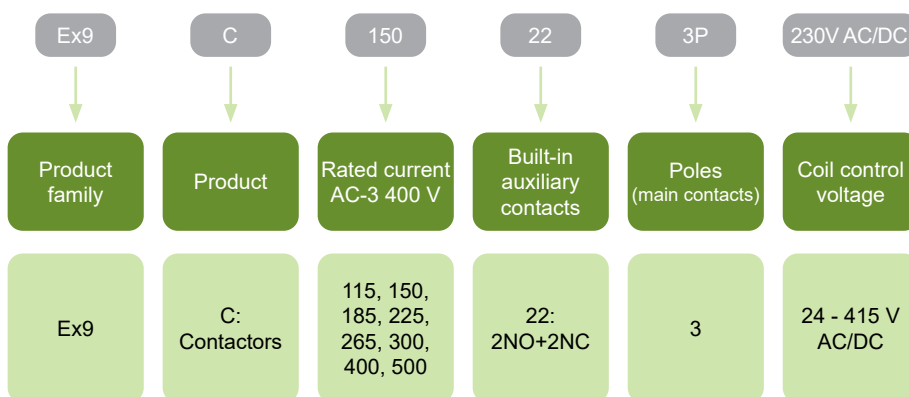

## Certification marks



# Contactors Ex9C up to 500 A

## Frame sizes



**Frame size 185**  
Rated currents  
115, 150, 185 A



**Frame size 300**  
Rated currents  
225, 265, 300 A



**Frame size 500**  
Rated currents  
400, 500 A

# Contactors Ex9C up to 500 A

## Accessories

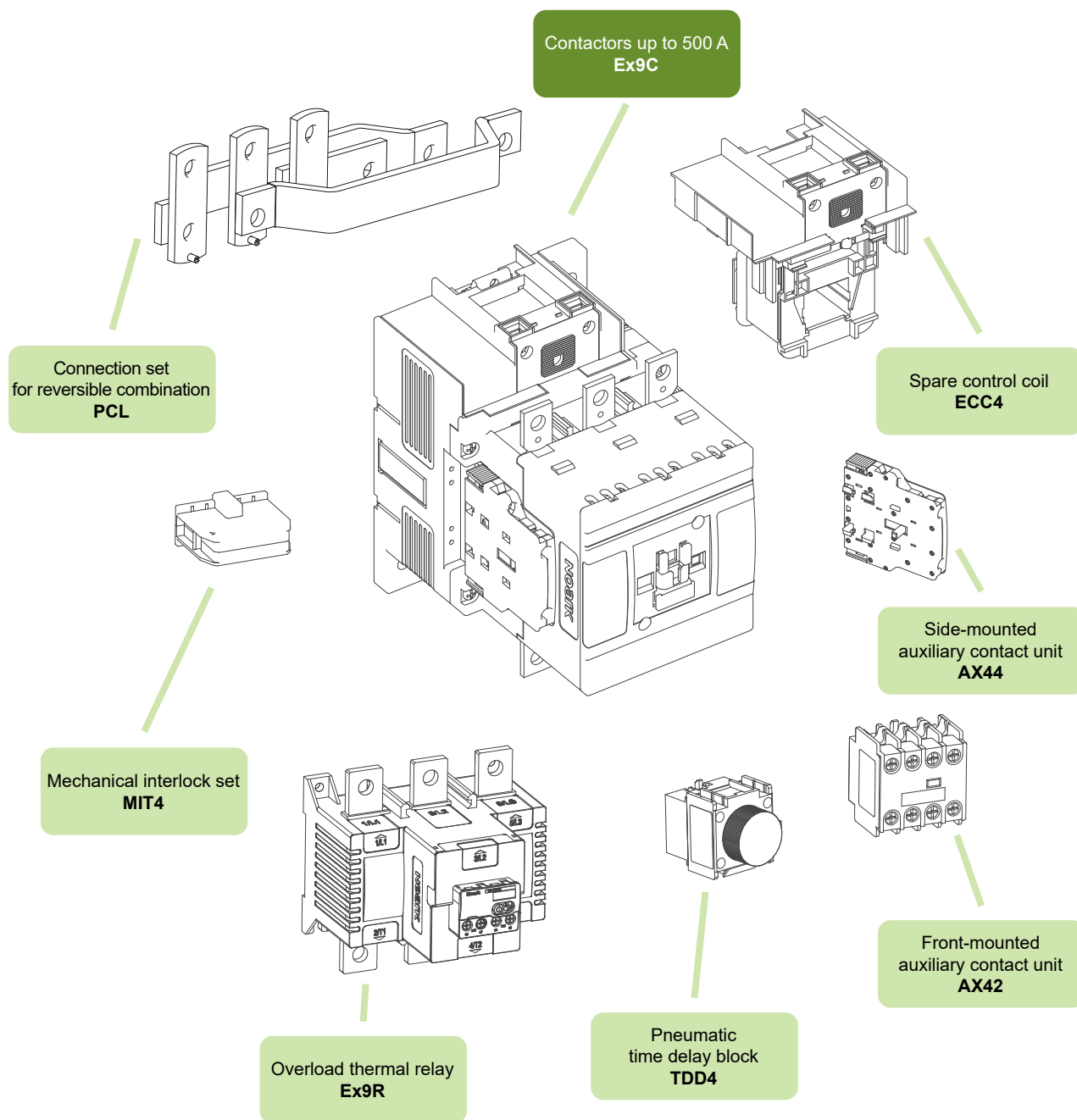

Front-mounted auxiliary contacts AX42  
 Side-mounted auxiliary contacts AX44  
 Overload thermal relays Ex9R  
 Pneumatic time delay block TDD4  
 Mechanical interlock MIT4  
 Connection set for reversible combination PCL  
 Spare control coil ECC4

see page 104  
 see page 105  
 see page 87  
 see page 106  
 see page 105  
 see page 105  
 see page 107

# Contactors Ex9C, frame size 185

## Rated current 115 A, 3-pole

- Mounting onto panel with screws
- Front-mounted auxiliary contacts AX42.. as well as side-mounted ones AX44.. can be used
- AC and DC control voltage
- Minimized power consumption of coil
- Can be combined with overload relays Ex9R185



Control voltage	$I_e$	Frame size	Poles	Auxiliary contacts	Article No.	Type	Packing
415 V AC/DC	115 A	185	3P	2NO+2NC	106213	Ex9C115 22 3P 415V AC/DC	1/2
400 V AC/DC	115 A	185	3P	2NO+2NC	106214	Ex9C115 22 3P 400V AC/DC	1/2
380 V AC/DC	115 A	185	3P	2NO+2NC	106215	Ex9C115 22 3P 380V AC/DC	1/2
240 V AC/DC	115 A	185	3P	2NO+2NC	106218	Ex9C115 22 3P 240V AC/DC	1/2
<b>230 V AC/DC</b>	<b>115 A</b>	<b>185</b>	<b>3P</b>	<b>2NO+2NC</b>	<b>106219</b>	<b>Ex9C115 22 3P 230V AC/DC</b>	<b>1/2</b>
220 V AC/DC	115 A	185	3P	2NO+2NC	106220	Ex9C115 22 3P 220V AC/DC	1/2
127 V AC/DC	115 A	185	3P	2NO+2NC	106221	Ex9C115 22 3P 127V AC/DC	1/2
110 V AC/DC	115 A	185	3P	2NO+2NC	106222	Ex9C115 22 3P 110V AC/DC	1/2
48 V AC/DC	115 A	185	3P	2NO+2NC	106211	Ex9C115 22 3P 48V AC/DC	1/2
42 V AC/DC	115 A	185	3P	2NO+2NC	106212	Ex9C115 22 3P 42V AC/DC	1/2
36 V AC/DC	115 A	185	3P	2NO+2NC	106216	Ex9C115 22 3P 36V AC/DC	1/2
<b>24 V AC/DC</b>	<b>115 A</b>	<b>185</b>	<b>3P</b>	<b>2NO+2NC</b>	<b>106217</b>	<b>Ex9C115 22 3P 24V AC/DC</b>	<b>1/2</b>

## Rated current 150 A, 3-pole

- Mounting onto panel with screws
- Front-mounted auxiliary contacts AX42.. as well as side-mounted ones AX44.. can be used
- AC and DC control voltage
- Minimized power consumption of coil
- Can be combined with overload relays Ex9R185



Control voltage	$I_e$	Frame size	Poles	Auxiliary contacts	Article No.	Type	Packing
415 V AC/DC	150 A	185	3P	2NO+2NC	106225	Ex9C150 22 3P 415V AC/DC	1/2
400 V AC/DC	150 A	185	3P	2NO+2NC	106226	Ex9C150 22 3P 400V AC/DC	1/2
380 V AC/DC	150 A	185	3P	2NO+2NC	106227	Ex9C150 22 3P 380V AC/DC	1/2
240 V AC/DC	150 A	185	3P	2NO+2NC	106230	Ex9C150 22 3P 240V AC/DC	1/2
<b>230 V AC/DC</b>	<b>150 A</b>	<b>185</b>	<b>3P</b>	<b>2NO+2NC</b>	<b>106231</b>	<b>Ex9C150 22 3P 230V AC/DC</b>	<b>1/2</b>
220 V AC/DC	150 A	185	3P	2NO+2NC	106232	Ex9C150 22 3P 220V AC/DC	1/2
127 V AC/DC	150 A	185	3P	2NO+2NC	106233	Ex9C150 22 3P 127V AC/DC	1/2
110 V AC/DC	150 A	185	3P	2NO+2NC	106234	Ex9C150 22 3P 110V AC/DC	1/2
48 V AC/DC	150 A	185	3P	2NO+2NC	106223	Ex9C150 22 3P 48V AC/DC	1/2
42 V AC/DC	150 A	185	3P	2NO+2NC	106224	Ex9C150 22 3P 42V AC/DC	1/2
36 V AC/DC	150 A	185	3P	2NO+2NC	106228	Ex9C150 22 3P 36V AC/DC	1/2
<b>24 V AC/DC</b>	<b>150 A</b>	<b>185</b>	<b>3P</b>	<b>2NO+2NC</b>	<b>106229</b>	<b>Ex9C150 22 3P 24V AC/DC</b>	<b>1/2</b>

# Contactors Ex9C, frame size 185

## Rated current 185 A, 3-pole

- Mounting onto panel with screws
- Front-mounted auxiliary contacts AX42.. as well as side-mounted ones AX44.. can be used
- AC and DC control voltage
- Minimized power consumption of coil
- Can be combined with overload relays Ex9R185



Control voltage	$I_e$	Frame size	Poles	Auxiliary contacts	Article No.	Type	Packing
415 V AC/DC	185 A	185	3P	2NO+2NC	106237	Ex9C185 22 3P 415V AC/DC	1/2
400 V AC/DC	185 A	185	3P	2NO+2NC	106238	Ex9C185 22 3P 400V AC/DC	1/2
380 V AC/DC	185 A	185	3P	2NO+2NC	106239	Ex9C185 22 3P 380V AC/DC	1/2
240 V AC/DC	185 A	185	3P	2NO+2NC	106242	Ex9C185 22 3P 240V AC/DC	1/2
<b>230 V AC/DC</b>	<b>185 A</b>	<b>185</b>	<b>3P</b>	<b>2NO+2NC</b>	<b>106243</b>	<b>Ex9C185 22 3P 230V AC/DC</b>	<b>1/2</b>
220 V AC/DC	185 A	185	3P	2NO+2NC	106244	Ex9C185 22 3P 220V AC/DC	1/2
127 V AC/DC	185 A	185	3P	2NO+2NC	106245	Ex9C185 22 3P 127V AC/DC	1/2
110 V AC/DC	185 A	185	3P	2NO+2NC	106246	Ex9C185 22 3P 110V AC/DC	1/2
48 V AC/DC	185 A	185	3P	2NO+2NC	106235	Ex9C185 22 3P 48V AC/DC	1/2
42 V AC/DC	185 A	185	3P	2NO+2NC	106236	Ex9C185 22 3P 42V AC/DC	1/2
36 V AC/DC	185 A	185	3P	2NO+2NC	106240	Ex9C185 22 3P 36V AC/DC	1/2
<b>24 V AC/DC</b>	<b>185 A</b>	<b>185</b>	<b>3P</b>	<b>2NO+2NC</b>	<b>106241</b>	<b>Ex9C185 22 3P 24V AC/DC</b>	<b>1/2</b>

### Wiring diagram

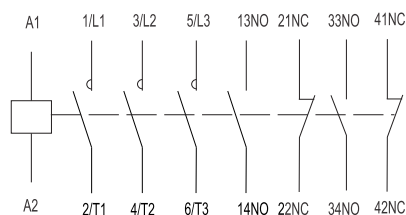

# Contactors Ex9C, frame size 300

## Rated current 225 A, 3-pole

- Mounting onto panel with screws
- Front-mounted auxiliary contacts AX42.. as well as side-mounted ones AX44.. can be used
- AC and DC control voltage
- Minimized power consumption of coil
- Can be combined with overload relays Ex9R500



Control voltage	$I_e$	Frame size	Poles	Auxiliary contacts	Article No.	Type	Packing
415 V AC/DC	225 A	300	3P	2NO+2NC	106249	Ex9C225 22 3P 415V AC/DC	1/2
400 V AC/DC	225 A	300	3P	2NO+2NC	106250	Ex9C225 22 3P 400V AC/DC	1/2
380 V AC/DC	225 A	300	3P	2NO+2NC	106251	Ex9C225 22 3P 380V AC/DC	1/2
240 V AC/DC	225 A	300	3P	2NO+2NC	106254	Ex9C225 22 3P 240V AC/DC	1/2
<b>230 V AC/DC</b>	<b>225 A</b>	<b>300</b>	<b>3P</b>	<b>2NO+2NC</b>	<b>106255</b>	<b>Ex9C225 22 3P 230V AC/DC</b>	<b>1/2</b>
220 V AC/DC	225 A	300	3P	2NO+2NC	106256	Ex9C225 22 3P 220V AC/DC	1/2
127 V AC/DC	225 A	300	3P	2NO+2NC	106257	Ex9C225 22 3P 127V AC/DC	1/2
110 V AC/DC	225 A	300	3P	2NO+2NC	106258	Ex9C225 22 3P 110V AC/DC	1/2
48 V AC/DC	225 A	300	3P	2NO+2NC	106247	Ex9C225 22 3P 48V AC/DC	1/2
42 V AC/DC	225 A	300	3P	2NO+2NC	106248	Ex9C225 22 3P 42V AC/DC	1/2
36 V AC/DC	225 A	300	3P	2NO+2NC	106252	Ex9C225 22 3P 36V AC/DC	1/2
<b>24 V AC/DC</b>	<b>225 A</b>	<b>300</b>	<b>3P</b>	<b>2NO+2NC</b>	<b>106253</b>	<b>Ex9C225 22 3P 24V AC/DC</b>	<b>1/2</b>

## Rated current 265 A, 3-pole

- Mounting onto panel with screws
- Front-mounted auxiliary contacts AX42.. as well as side-mounted ones AX44.. can be used
- AC and DC control voltage
- Minimized power consumption of coil
- Can be combined with overload relays Ex9R500



Control voltage	$I_e$	Frame size	Poles	Auxiliary contacts	Article No.	Type	Packing
415 V AC/DC	265 A	300	3P	2NO+2NC	106261	Ex9C265 22 3P 415V AC/DC	1/2
400 V AC/DC	265 A	300	3P	2NO+2NC	106262	Ex9C265 22 3P 400V AC/DC	1/2
380 V AC/DC	265 A	300	3P	2NO+2NC	106263	Ex9C265 22 3P 380V AC/DC	1/2
240 V AC/DC	265 A	300	3P	2NO+2NC	106266	Ex9C265 22 3P 240V AC/DC	1/2
<b>230 V AC/DC</b>	<b>265 A</b>	<b>300</b>	<b>3P</b>	<b>2NO+2NC</b>	<b>106267</b>	<b>Ex9C265 22 3P 230V AC/DC</b>	<b>1/2</b>
220 V AC/DC	265 A	300	3P	2NO+2NC	106268	Ex9C265 22 3P 220V AC/DC	1/2
127 V AC/DC	265 A	300	3P	2NO+2NC	106269	Ex9C265 22 3P 127V AC/DC	1/2
110 V AC/DC	265 A	300	3P	2NO+2NC	106270	Ex9C265 22 3P 110V AC/DC	1/2
48 V AC/DC	265 A	300	3P	2NO+2NC	106259	Ex9C265 22 3P 48V AC/DC	1/2
42 V AC/DC	265 A	300	3P	2NO+2NC	106260	Ex9C265 22 3P 42V AC/DC	1/2
36 V AC/DC	265 A	300	3P	2NO+2NC	106264	Ex9C265 22 3P 36V AC/DC	1/2
<b>24 V AC/DC</b>	<b>265 A</b>	<b>300</b>	<b>3P</b>	<b>2NO+2NC</b>	<b>106265</b>	<b>Ex9C265 22 3P 24V AC/DC</b>	<b>1/2</b>

# Contactors Ex9C, frame size 300

## Rated current 300 A, 3-pole

- Mounting onto panel with screws
- Front-mounted auxiliary contacts AX42.. as well as side-mounted ones AX44.. can be used
- AC and DC control voltage
- Minimized power consumption of coil
- Can be combined with overload relays Ex9R500



Control voltage	$I_e$	Frame size	Poles	Auxiliary contacts	Article No.	Type	Packing
415 V AC/DC	300 A	300	3P	2NO+2NC	106273	Ex9C300 22 3P 415V AC/DC	1/2
400 V AC/DC	300 A	300	3P	2NO+2NC	106274	Ex9C300 22 3P 400V AC/DC	1/2
380 V AC/DC	300 A	300	3P	2NO+2NC	106275	Ex9C300 22 3P 380V AC/DC	1/2
240 V AC/DC	300 A	300	3P	2NO+2NC	106278	Ex9C300 22 3P 240V AC/DC	1/2
<b>230 V AC/DC</b>	<b>300 A</b>	<b>300</b>	<b>3P</b>	<b>2NO+2NC</b>	<b>106279</b>	<b>Ex9C300 22 3P 230V AC/DC</b>	<b>1/2</b>
220 V AC/DC	300 A	300	3P	2NO+2NC	106280	Ex9C300 22 3P 220V AC/DC	1/2
127 V AC/DC	300 A	300	3P	2NO+2NC	106281	Ex9C300 22 3P 127V AC/DC	1/2
110 V AC/DC	300 A	300	3P	2NO+2NC	106282	Ex9C300 22 3P 110V AC/DC	1/2
48 V AC/DC	300 A	300	3P	2NO+2NC	106271	Ex9C300 22 3P 48V AC/DC	1/2
42 V AC/DC	300 A	300	3P	2NO+2NC	106272	Ex9C300 22 3P 42V AC/DC	1/2
36 V AC/DC	300 A	300	3P	2NO+2NC	106276	Ex9C300 22 3P 36V AC/DC	1/2
<b>24 V AC/DC</b>	<b>300 A</b>	<b>300</b>	<b>3P</b>	<b>2NO+2NC</b>	<b>106277</b>	<b>Ex9C300 22 3P 24V AC/DC</b>	<b>1/2</b>

### Wiring diagram

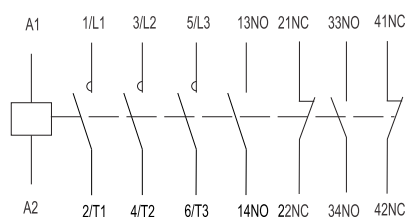

# Contactors Ex9C, frame size 500

## Rated current 400 A, 3-pole

- Mounting onto panel with screws
- Front-mounted auxiliary contacts AX42.. as well as side-mounted ones AX44.. can be used
- AC and DC control voltage
- Minimized power consumption of coil
- Can be combined with overload relays Ex9R500



Control voltage	$I_e$	Frame size	Poles	Auxiliary contacts	Article No.	Type	Packing
415 V AC/DC	400 A	500	3P	2NO+2NC	106285	Ex9C400 22 3P 415V AC/DC	1/1
400 V AC/DC	400 A	500	3P	2NO+2NC	106286	Ex9C400 22 3P 400V AC/DC	1/1
380 V AC/DC	400 A	500	3P	2NO+2NC	106287	Ex9C400 22 3P 380V AC/DC	1/1
240 V AC/DC	400 A	500	3P	2NO+2NC	106290	Ex9C400 22 3P 240V AC/DC	1/1
<b>230 V AC/DC</b>	<b>400 A</b>	<b>500</b>	<b>3P</b>	<b>2NO+2NC</b>	<b>106291</b>	<b>Ex9C400 22 3P 230V AC/DC</b>	<b>1/1</b>
220 V AC/DC	400 A	500	3P	2NO+2NC	106292	Ex9C400 22 3P 220V AC/DC	1/1
127 V AC/DC	400 A	500	3P	2NO+2NC	106293	Ex9C400 22 3P 127V AC/DC	1/1
110 V AC/DC	400 A	500	3P	2NO+2NC	106294	Ex9C400 22 3P 110V AC/DC	1/1
48 V AC/DC	400 A	500	3P	2NO+2NC	106283	Ex9C400 22 3P 48V AC/DC	1/1
42 V AC/DC	400 A	500	3P	2NO+2NC	106284	Ex9C400 22 3P 42V AC/DC	1/1
36 V AC/DC	400 A	500	3P	2NO+2NC	106288	Ex9C400 22 3P 36V AC/DC	1/1
<b>24 V AC/DC</b>	<b>400 A</b>	<b>500</b>	<b>3P</b>	<b>2NO+2NC</b>	<b>106289</b>	<b>Ex9C400 22 3P 24V AC/DC</b>	<b>1/1</b>

Technical data p. 190

## Rated current 500 A, 3-pole

- Mounting onto panel with screws
- Front-mounted auxiliary contacts AX42.. as well as side-mounted ones AX44.. can be used
- AC and DC control voltage
- Minimized power consumption of coil
- Can be combined with overload relays Ex9R500



Control voltage	$I_e$	Frame size	Poles	Auxiliary contacts	Article No.	Type	Packing
415 V AC/DC	500 A	500	3P	2NO+2NC	106297	Ex9C500 22 3P 415V AC/DC	1/1
400 V AC/DC	500 A	500	3P	2NO+2NC	106298	Ex9C500 22 3P 400V AC/DC	1/1
380 V AC/DC	500 A	500	3P	2NO+2NC	106299	Ex9C500 22 3P 380V AC/DC	1/1
240 V AC/DC	500 A	500	3P	2NO+2NC	106302	Ex9C500 22 3P 240V AC/DC	1/1
<b>230 V AC/DC</b>	<b>500 A</b>	<b>500</b>	<b>3P</b>	<b>2NO+2NC</b>	<b>106303</b>	<b>Ex9C500 22 3P 230V AC/DC</b>	<b>1/1</b>
220 V AC/DC	500 A	500	3P	2NO+2NC	106304	Ex9C500 22 3P 220V AC/DC	1/1
127 V AC/DC	500 A	500	3P	2NO+2NC	106305	Ex9C500 22 3P 127V AC/DC	1/1
110 V AC/DC	500 A	500	3P	2NO+2NC	106306	Ex9C500 22 3P 110V AC/DC	1/1
48 V AC/DC	500 A	500	3P	2NO+2NC	106295	Ex9C500 22 3P 48V AC/DC	1/1
42 V AC/DC	500 A	500	3P	2NO+2NC	106296	Ex9C500 22 3P 42V AC/DC	1/1
36 V AC/DC	500 A	500	3P	2NO+2NC	106300	Ex9C500 22 3P 36V AC/DC	1/1
<b>24 V AC/DC</b>	<b>500 A</b>	<b>500</b>	<b>3P</b>	<b>2NO+2NC</b>	<b>106301</b>	<b>Ex9C500 22 3P 24V AC/DC</b>	<b>1/1</b>

### Wiring diagram

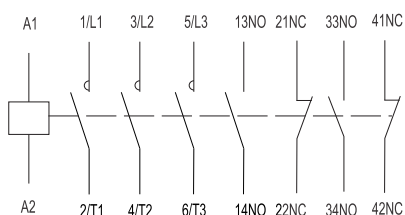

Technical data p. 190



# Capacitor contactors Ex9CC



- Contactors for switching of capacity loads, especially power factor compensation capacitors
- Tested according to IEC / EN 60947-4-1
- 3-pole versions
- Rated current AC-6b up to 100 A
- Coil control voltage 24 — 415 V AC
- Mounting onto DIN rail or onto panel
- Variants for compensation up to 60 kvar at 400 V

Capacitor contactors Ex9CC are used mainly for switching power factor correction blocks. These types of contactors are fitted and delivered with special front mounted block of series resistors which ensures early making of auxiliary poles and connect the capacitor to the network via the set of resistors, when the coil is energized. The contactor with this current suppression block can effectively reduce the current impact of the capacitors and operational overvoltage. Utilization category of these contactors is AC-6b.

## Type Key

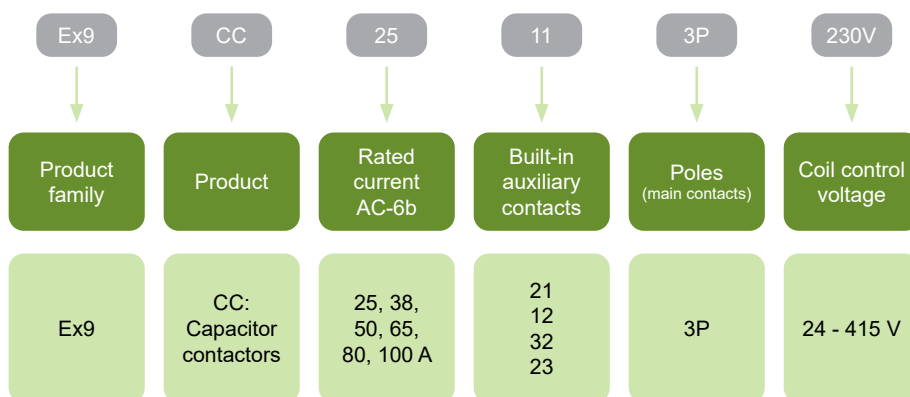

## Certification marks



# Capacitor contactors Ex9CC

## Frame sizes



**Frame size 38**  
Rated currents 25, 38 A  
Rated power 16, 25 kvar at 400 V



**Frame size 65**  
Rated currents 50, 65 A  
Rated power 30, 40 kvar at 400 V



**Frame size 100**  
Rated currents 80, 100 A  
Rated power 50, 60 kvar at 400 V

# Capacitor contactors Ex9CC

## Accessories

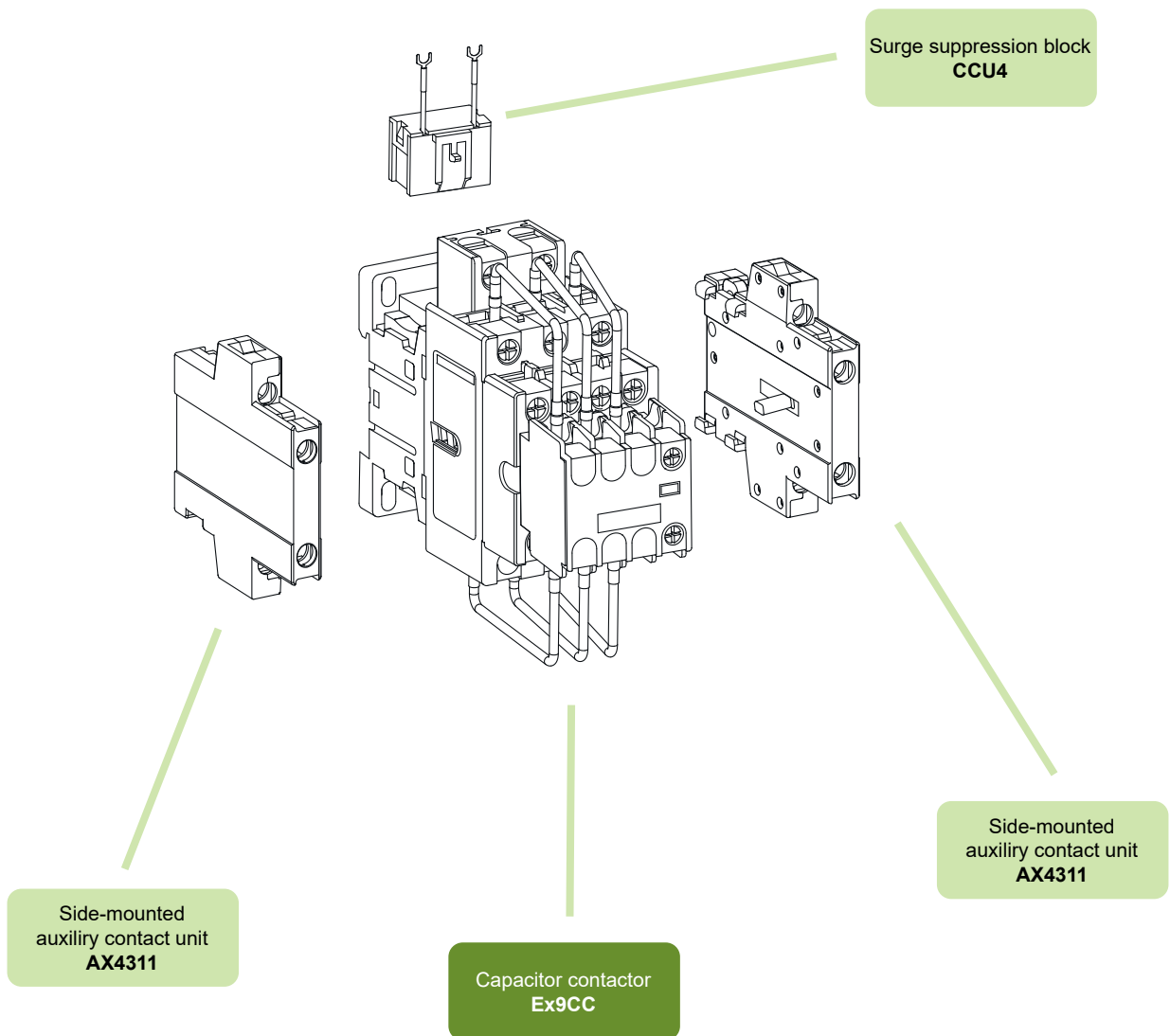

Auxiliary contacts AX4311  
Surge suppression block CCU4

see page 104  
see page 106

# Capacitor contactors Ex9CC

## Rated current 25 A AC-6b, 3-pole

- For compensation up to 16 kvar at 400 V AC
- Mounting onto device DIN rail or onto panel
- Side-mounted auxiliary contacts AX43 can be used



Control voltage	AC-6b current	Frame size	Auxiliary contacts	Article No.	Type	Packing
415 V AC	25 A	38	1 NO + 2 NC	104203	Ex9CC25 12 3P 415V	1/14
400 V AC	25 A	38	1 NO + 2 NC	104202	Ex9CC25 12 3P 400V	1/14
380 V AC	25 A	38	1 NO + 2 NC	104201	Ex9CC25 12 3P 380V	1/14
240 V AC	25 A	38	1 NO + 2 NC	104198	Ex9CC25 12 3P 240V	1/14
<b>230 V AC</b>	<b>25 A</b>	<b>38</b>	<b>1 NO + 2 NC</b>	<b>104197</b>	<b>Ex9CC25 12 3P 230V</b>	<b>1/14</b>
220 V AC	25 A	38	1 NO + 2 NC	104196	Ex9CC25 12 3P 220V	1/14
127 V AC	25 A	38	1 NO + 2 NC	104195	Ex9CC25 12 3P 127V	1/14
110 V AC	25 A	38	1 NO + 2 NC	104194	Ex9CC25 12 3P 110V	1/14
48 V AC	25 A	38	1 NO + 2 NC	104205	Ex9CC25 12 3P 48V	1/14
42 V AC	25 A	38	1 NO + 2 NC	104204	Ex9CC25 12 3P 42V	1/14
36 V AC	25 A	38	1 NO + 2 NC	104200	Ex9CC25 12 3P 36V	1/14
24 V AC	25 A	38	1 NO + 2 NC	104199	Ex9CC25 12 3P 24V	1/14
415 V AC	25 A	38	2 NO + 1 NC	104215	Ex9CC25 21 3P 415V	1/14
400 V AC	25 A	38	2 NO + 1 NC	104214	Ex9CC25 21 3P 400V	1/14
380 V AC	25 A	38	2 NO + 1 NC	104213	Ex9CC25 21 3P 380V	1/14
240 V AC	25 A	38	2 NO + 1 NC	104210	Ex9CC25 21 3P 240V	1/14
<b>230 V AC</b>	<b>25 A</b>	<b>38</b>	<b>2 NO + 1 NC</b>	<b>104209</b>	<b>Ex9CC25 21 3P 230V</b>	<b>1/14</b>
220 V AC	25 A	38	2 NO + 1 NC	104208	Ex9CC25 21 3P 220V	1/14
127 V AC	25 A	38	2 NO + 1 NC	104207	Ex9CC25 21 3P 127V	1/14
110 V AC	25 A	38	2 NO + 1 NC	104206	Ex9CC25 21 3P 110V	1/14
48 V AC	25 A	38	2 NO + 1 NC	104217	Ex9CC25 21 3P 48V	1/14
42 V AC	25 A	38	2 NO + 1 NC	104216	Ex9CC25 21 3P 42V	1/14
36 V AC	25 A	38	2 NO + 1 NC	104212	Ex9CC25 21 3P 36V	1/14
24 V AC	25 A	38	2 NO + 1 NC	104211	Ex9CC25 21 3P 24V	1/14
415 V AC	25 A	38	2 NO + 3 NC	104227	Ex9CC25 23 3P 415V	1/14
400 V AC	25 A	38	2 NO + 3 NC	104226	Ex9CC25 23 3P 400V	1/14
380 V AC	25 A	38	2 NO + 3 NC	104225	Ex9CC25 23 3P 380V	1/14
240 V AC	25 A	38	2 NO + 3 NC	104222	Ex9CC25 23 3P 240V	1/14
<b>230 V AC</b>	<b>25 A</b>	<b>38</b>	<b>2 NO + 3 NC</b>	<b>104221</b>	<b>Ex9CC25 23 3P 230V</b>	<b>1/14</b>
220 V AC	25 A	38	2 NO + 3 NC	104220	Ex9CC25 23 3P 220V	1/14
127 V AC	25 A	38	2 NO + 3 NC	104219	Ex9CC25 23 3P 127V	1/14
110 V AC	25 A	38	2 NO + 3 NC	104218	Ex9CC25 23 3P 110V	1/14
48 V AC	25 A	38	2 NO + 3 NC	104229	Ex9CC25 23 3P 48V	1/14
42 V AC	25 A	38	2 NO + 3 NC	104228	Ex9CC25 23 3P 42V	1/14
36 V AC	25 A	38	2 NO + 3 NC	104224	Ex9CC25 23 3P 36V	1/14
24 V AC	25 A	38	2 NO + 3 NC	104223	Ex9CC25 23 3P 24V	1/14
415 V AC	25 A	38	3 NO + 2 NC	104239	Ex9CC25 32 3P 415V	1/14
400 V AC	25 A	38	3 NO + 2 NC	104238	Ex9CC25 32 3P 400V	1/14
380 V AC	25 A	38	3 NO + 2 NC	104237	Ex9CC25 32 3P 380V	1/14
240 V AC	25 A	38	3 NO + 2 NC	104234	Ex9CC25 32 3P 240V	1/14
<b>230 V AC</b>	<b>25 A</b>	<b>38</b>	<b>3 NO + 2 NC</b>	<b>104233</b>	<b>Ex9CC25 32 3P 230V</b>	<b>1/14</b>
220 V AC	25 A	38	3 NO + 2 NC	104232	Ex9CC25 32 3P 220V	1/14
127 V AC	25 A	38	3 NO + 2 NC	104231	Ex9CC25 32 3P 127V	1/14
110 V AC	25 A	38	3 NO + 2 NC	104230	Ex9CC25 32 3P 110V	1/14
48 V AC	25 A	38	3 NO + 2 NC	104241	Ex9CC25 32 3P 48V	1/14
42 V AC	25 A	38	3 NO + 2 NC	104240	Ex9CC25 32 3P 42V	1/14
36 V AC	25 A	38	3 NO + 2 NC	104236	Ex9CC25 32 3P 36V	1/14
24 V AC	25 A	38	3 NO + 2 NC	104235	Ex9CC25 32 3P 24V	1/14

Main terminals wiring diagram

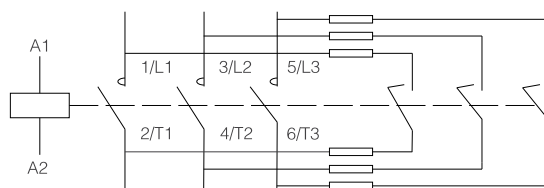

# Capacitor contactors Ex9CC

## Rated current 38 A AC-6b, 3-pole

- For compensation up to 25 kvar at 400 V AC
- Mounting onto device DIN rail or onto panel
- Side-mounted auxiliary contacts AX43 can be used



Control voltage	AC-6b current	Frame size	Auxiliary contacts	Article No.	Type	Packing
415 V AC	38 A	38	1 NO + 2 NC	104251	Ex9CC38 12 3P 415V	1/14
400 V AC	38 A	38	1 NO + 2 NC	104250	Ex9CC38 12 3P 400V	1/14
380 V AC	38 A	38	1 NO + 2 NC	104249	Ex9CC38 12 3P 380V	1/14
240 V AC	38 A	38	1 NO + 2 NC	104246	Ex9CC38 12 3P 240V	1/14
<b>230 V AC</b>	<b>38 A</b>	<b>38</b>	<b>1 NO + 2 NC</b>	<b>104245</b>	<b>Ex9CC38 12 3P 230V</b>	<b>1/14</b>
220 V AC	38 A	38	1 NO + 2 NC	104244	Ex9CC38 12 3P 220V	1/14
127 V AC	38 A	38	1 NO + 2 NC	104243	Ex9CC38 12 3P 127V	1/14
110 V AC	38 A	38	1 NO + 2 NC	104242	Ex9CC38 12 3P 110V	1/14
48 V AC	38 A	38	1 NO + 2 NC	104253	Ex9CC38 12 3P 48V	1/14
42 V AC	38 A	38	1 NO + 2 NC	104252	Ex9CC38 12 3P 42V	1/14
36 V AC	38 A	38	1 NO + 2 NC	104248	Ex9CC38 12 3P 36V	1/14
24 V AC	38 A	38	1 NO + 2 NC	104247	Ex9CC38 12 3P 24V	1/14
415 V AC	38 A	38	2 NO + 1 NC	104263	Ex9CC38 21 3P 415V	1/14
400 V AC	38 A	38	2 NO + 1 NC	104262	Ex9CC38 21 3P 400V	1/14
380 V AC	38 A	38	2 NO + 1 NC	104261	Ex9CC38 21 3P 380V	1/14
240 V AC	38 A	38	2 NO + 1 NC	104258	Ex9CC38 21 3P 240V	1/14
<b>230 V AC</b>	<b>38 A</b>	<b>38</b>	<b>2 NO + 1 NC</b>	<b>104257</b>	<b>Ex9CC38 21 3P 230V</b>	<b>1/14</b>
220 V AC	38 A	38	2 NO + 1 NC	104256	Ex9CC38 21 3P 220V	1/14
127 V AC	38 A	38	2 NO + 1 NC	104255	Ex9CC38 21 3P 127V	1/14
110 V AC	38 A	38	2 NO + 1 NC	104254	Ex9CC38 21 3P 110V	1/14
48 V AC	38 A	38	2 NO + 1 NC	104265	Ex9CC38 21 3P 48V	1/14
42 V AC	38 A	38	2 NO + 1 NC	104264	Ex9CC38 21 3P 42V	1/14
36 V AC	38 A	38	2 NO + 1 NC	104260	Ex9CC38 21 3P 36V	1/14
24 V AC	38 A	38	2 NO + 1 NC	104259	Ex9CC38 21 3P 24V	1/14
415 V AC	38 A	38	2 NO + 3 NC	104275	Ex9CC38 23 3P 415V	1/14
400 V AC	38 A	38	2 NO + 3 NC	104274	Ex9CC38 23 3P 400V	1/14
380 V AC	38 A	38	2 NO + 3 NC	104273	Ex9CC38 23 3P 380V	1/14
240 V AC	38 A	38	2 NO + 3 NC	104270	Ex9CC38 23 3P 240V	1/14
<b>230 V AC</b>	<b>38 A</b>	<b>38</b>	<b>2 NO + 3 NC</b>	<b>104269</b>	<b>Ex9CC38 23 3P 230V</b>	<b>1/14</b>
220 V AC	38 A	38	2 NO + 3 NC	104268	Ex9CC38 23 3P 220V	1/14
127 V AC	38 A	38	2 NO + 3 NC	104267	Ex9CC38 23 3P 127V	1/14
110 V AC	38 A	38	2 NO + 3 NC	104266	Ex9CC38 23 3P 110V	1/14
48 V AC	38 A	38	2 NO + 3 NC	104277	Ex9CC38 23 3P 48V	1/14
42 V AC	38 A	38	2 NO + 3 NC	104276	Ex9CC38 23 3P 42V	1/14
36 V AC	38 A	38	2 NO + 3 NC	104272	Ex9CC38 23 3P 36V	1/14
24 V AC	38 A	38	2 NO + 3 NC	104271	Ex9CC38 23 3P 24V	1/14
415 V AC	38 A	38	3 NO + 2 NC	104287	Ex9CC38 32 3P 415V	1/14
400 V AC	38 A	38	3 NO + 2 NC	104286	Ex9CC38 32 3P 400V	1/14
380 V AC	38 A	38	3 NO + 2 NC	104285	Ex9CC38 32 3P 380V	1/14
240 V AC	38 A	38	3 NO + 2 NC	104282	Ex9CC38 32 3P 240V	1/14
<b>230 V AC</b>	<b>38 A</b>	<b>38</b>	<b>3 NO + 2 NC</b>	<b>104281</b>	<b>Ex9CC38 32 3P 230V</b>	<b>1/14</b>
220 V AC	38 A	38	3 NO + 2 NC	104280	Ex9CC38 32 3P 220V	1/14
127 V AC	38 A	38	3 NO + 2 NC	104279	Ex9CC38 32 3P 127V	1/14
110 V AC	38 A	38	3 NO + 2 NC	104278	Ex9CC38 32 3P 110V	1/14
48 V AC	38 A	38	3 NO + 2 NC	104289	Ex9CC38 32 3P 48V	1/14
42 V AC	38 A	38	3 NO + 2 NC	104288	Ex9CC38 32 3P 42V	1/14
36 V AC	38 A	38	3 NO + 2 NC	104284	Ex9CC38 32 3P 36V	1/14
24 V AC	38 A	38	3 NO + 2 NC	104283	Ex9CC38 32 3P 24V	1/14

Main terminals wiring diagram

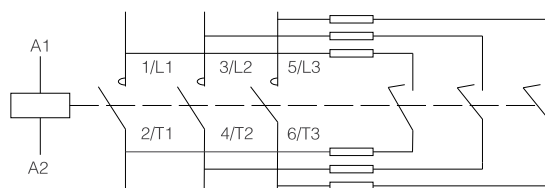

# Capacitor contactors Ex9CC

## Rated current 50 A AC-6b, 3-pole

- For compensation up to 30 kvar at 400 V AC
- Mounting onto device DIN rail or onto panel
- Side-mounted auxiliary contacts AX43 can be used



Control voltage	AC-6b current	Frame size	Auxiliary contacts	Article No.	Type	Packing
415 V AC	50 A	65	1 NO + 2 NC	104299	Ex9CC50 12 3P 415V	1/6
400 V AC	50 A	65	1 NO + 2 NC	104298	Ex9CC50 12 3P 400V	1/6
380 V AC	50 A	65	1 NO + 2 NC	104297	Ex9CC50 12 3P 380V	1/6
240 V AC	50 A	65	1 NO + 2 NC	104294	Ex9CC50 12 3P 240V	1/6
<b>230 V AC</b>	<b>50 A</b>	<b>65</b>	<b>1 NO + 2 NC</b>	<b>104293</b>	<b>Ex9CC50 12 3P 230V</b>	<b>1/6</b>
220 V AC	50 A	65	1 NO + 2 NC	104292	Ex9CC50 12 3P 220V	1/6
127 V AC	50 A	65	1 NO + 2 NC	104291	Ex9CC50 12 3P 127V	1/6
110 V AC	50 A	65	1 NO + 2 NC	104290	Ex9CC50 12 3P 110V	1/6
48 V AC	50 A	65	1 NO + 2 NC	104301	Ex9CC50 12 3P 48V	1/6
42 V AC	50 A	65	1 NO + 2 NC	104300	Ex9CC50 12 3P 42V	1/6
36 V AC	50 A	65	1 NO + 2 NC	104296	Ex9CC50 12 3P 36V	1/6
24 V AC	50 A	65	1 NO + 2 NC	104295	Ex9CC50 12 3P 24V	1/6
415 V AC	50 A	65	2 NO + 1 NC	104311	Ex9CC50 21 3P 415V	1/6
400 V AC	50 A	65	2 NO + 1 NC	104310	Ex9CC50 21 3P 400V	1/6
380 V AC	50 A	65	2 NO + 1 NC	104309	Ex9CC50 21 3P 380V	1/6
240 V AC	50 A	65	2 NO + 1 NC	104306	Ex9CC50 21 3P 240V	1/6
<b>230 V AC</b>	<b>50 A</b>	<b>65</b>	<b>2 NO + 1 NC</b>	<b>104305</b>	<b>Ex9CC50 21 3P 230V</b>	<b>1/6</b>
220 V AC	50 A	65	2 NO + 1 NC	104304	Ex9CC50 21 3P 220V	1/6
127 V AC	50 A	65	2 NO + 1 NC	104303	Ex9CC50 21 3P 127V	1/6
110 V AC	50 A	65	2 NO + 1 NC	104302	Ex9CC50 21 3P 110V	1/6
48 V AC	50 A	65	2 NO + 1 NC	104313	Ex9CC50 21 3P 48V	1/6
42 V AC	50 A	65	2 NO + 1 NC	104312	Ex9CC50 21 3P 42V	1/6
36 V AC	50 A	65	2 NO + 1 NC	104308	Ex9CC50 21 3P 36V	1/6
24 V AC	50 A	65	2 NO + 1 NC	104307	Ex9CC50 21 3P 24V	1/6

Main terminals wiring diagram

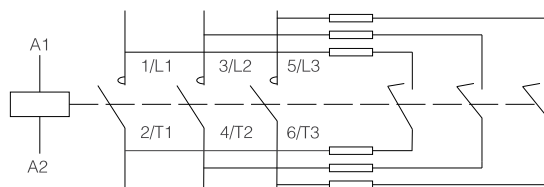

# Capacitor contactors Ex9CC

## Rated current 65 A AC-6b, 3-pole

- For compensation up to 40 kvar at 400 V AC
- Mounting onto device DIN rail or onto panel
- Side-mounted auxiliary contacts AX43 can be used



Control voltage	AC-6b current	Frame size	Auxiliary contacts	Article No.	Type	Packing
415 V AC	65 A	65	1 NO + 2 NC	104323	Ex9CC65 12 3P 415V	1/6
400 V AC	65 A	65	1 NO + 2 NC	104322	Ex9CC65 12 3P 400V	1/6
380 V AC	65 A	65	1 NO + 2 NC	104321	Ex9CC65 12 3P 380V	1/6
240 V AC	65 A	65	1 NO + 2 NC	104318	Ex9CC65 12 3P 240V	1/6
<b>230 V AC</b>	<b>65 A</b>	<b>65</b>	<b>1 NO + 2 NC</b>	<b>104317</b>	<b>Ex9CC65 12 3P 230V</b>	<b>1/6</b>
220 V AC	65 A	65	1 NO + 2 NC	104316	Ex9CC65 12 3P 220V	1/6
127 V AC	65 A	65	1 NO + 2 NC	104315	Ex9CC65 12 3P 127V	1/6
110 V AC	65 A	65	1 NO + 2 NC	104314	Ex9CC65 12 3P 110V	1/6
48 V AC	65 A	65	1 NO + 2 NC	104325	Ex9CC65 12 3P 48V	1/6
42 V AC	65 A	65	1 NO + 2 NC	104324	Ex9CC65 12 3P 42V	1/6
36 V AC	65 A	65	1 NO + 2 NC	104320	Ex9CC65 12 3P 36V	1/6
24 V AC	65 A	65	1 NO + 2 NC	104319	Ex9CC65 12 3P 24V	1/6
415 V AC	65 A	65	2 NO + 1 NC	104335	Ex9CC65 21 3P 415V	1/6
400 V AC	65 A	65	2 NO + 1 NC	104334	Ex9CC65 21 3P 400V	1/6
380 V AC	65 A	65	2 NO + 1 NC	104333	Ex9CC65 21 3P 380V	1/6
240 V AC	65 A	65	2 NO + 1 NC	104330	Ex9CC65 21 3P 240V	1/6
<b>230 V AC</b>	<b>65 A</b>	<b>65</b>	<b>2 NO + 1 NC</b>	<b>104329</b>	<b>Ex9CC65 21 3P 230V</b>	<b>1/6</b>
220 V AC	65 A	65	2 NO + 1 NC	104328	Ex9CC65 21 3P 220V	1/6
127 V AC	65 A	65	2 NO + 1 NC	104327	Ex9CC65 21 3P 127V	1/6
110 V AC	65 A	65	2 NO + 1 NC	104326	Ex9CC65 21 3P 110V	1/6
48 V AC	65 A	65	2 NO + 1 NC	104337	Ex9CC65 21 3P 48V	1/6
42 V AC	65 A	65	2 NO + 1 NC	104336	Ex9CC65 21 3P 42V	1/6
36 V AC	65 A	65	2 NO + 1 NC	104332	Ex9CC65 21 3P 36V	1/6
24 V AC	65 A	65	2 NO + 1 NC	104331	Ex9CC65 21 3P 24V	1/6

Main terminals wiring diagram

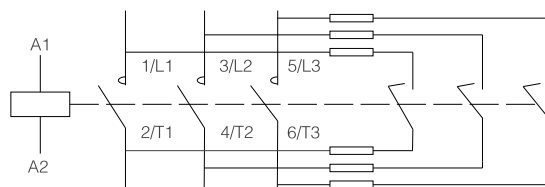

# Capacitor contactors Ex9CC

## Rated current 80 A AC-6b, 3-pole

- For compensation up to 50 kvar at 400 V AC
- Mounting onto device DIN rail or onto panel
- Side-mounted auxiliary contacts AX43 can be used



Control voltage	AC-6b current	Frame size	Auxiliary contacts	Article No.	Type	Packing
415 V AC	80 A	100	1 NO + 2 NC	104347	Ex9CC80 12 3P 415V	1/6
400 V AC	80 A	100	1 NO + 2 NC	104346	Ex9CC80 12 3P 400V	1/6
380 V AC	80 A	100	1 NO + 2 NC	104345	Ex9CC80 12 3P 380V	1/6
240 V AC	80 A	100	1 NO + 2 NC	104342	Ex9CC80 12 3P 240V	1/6
<b>230 V AC</b>	<b>80 A</b>	<b>100</b>	<b>1 NO + 2 NC</b>	<b>104341</b>	<b>Ex9CC80 12 3P 230V</b>	<b>1/6</b>
220 V AC	80 A	100	1 NO + 2 NC	104340	Ex9CC80 12 3P 220V	1/6
127 V AC	80 A	100	1 NO + 2 NC	104339	Ex9CC80 12 3P 127V	1/6
110 V AC	80 A	100	1 NO + 2 NC	104338	Ex9CC80 12 3P 110V	1/6
48 V AC	80 A	100	1 NO + 2 NC	104349	Ex9CC80 12 3P 48V	1/6
42 V AC	80 A	100	1 NO + 2 NC	104348	Ex9CC80 12 3P 42V	1/6
36 V AC	80 A	100	1 NO + 2 NC	104344	Ex9CC80 12 3P 36V	1/6
24 V AC	80 A	100	1 NO + 2 NC	104343	Ex9CC80 12 3P 24V	1/6
415 V AC	80 A	100	2 NO + 1 NC	104359	Ex9CC80 21 3P 415V	1/6
400 V AC	80 A	100	2 NO + 1 NC	104358	Ex9CC80 21 3P 400V	1/6
380 V AC	80 A	100	2 NO + 1 NC	104357	Ex9CC80 21 3P 380V	1/6
240 V AC	80 A	100	2 NO + 1 NC	104354	Ex9CC80 21 3P 240V	1/6
<b>230 V AC</b>	<b>80 A</b>	<b>100</b>	<b>2 NO + 1 NC</b>	<b>104353</b>	<b>Ex9CC80 21 3P 230V</b>	<b>1/6</b>
220 V AC	80 A	100	2 NO + 1 NC	104352	Ex9CC80 21 3P 220V	1/6
127 V AC	80 A	100	2 NO + 1 NC	104351	Ex9CC80 21 3P 127V	1/6
110 V AC	80 A	100	2 NO + 1 NC	104350	Ex9CC80 21 3P 110V	1/6
48 V AC	80 A	100	2 NO + 1 NC	104361	Ex9CC80 21 3P 48V	1/6
42 V AC	80 A	100	2 NO + 1 NC	104360	Ex9CC80 21 3P 42V	1/6
36 V AC	80 A	100	2 NO + 1 NC	104356	Ex9CC80 21 3P 36V	1/6
24 V AC	80 A	100	2 NO + 1 NC	104355	Ex9CC80 21 3P 24V	1/6

Main terminals wiring diagram

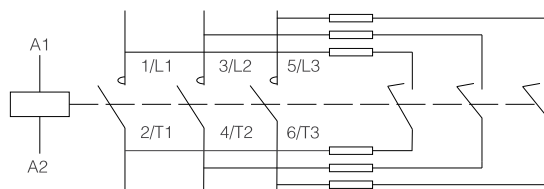



# Capacitor contactors Ex9CC

## Rated current 100 A AC-6b, 3-pole

- For compensation up to 60 kvar at 400 V AC
- Mounting onto device DIN rail or onto panel
- Side-mounted auxiliary contacts AX43 can be used



Control voltage	AC-6b current	Frame size	Auxiliary contacts	Article No.	Type	Packing
415 V AC	100 A	100	1 NO + 2 NC	104371	Ex9CC100 12 3P 415V	1/6
400 V AC	100 A	100	1 NO + 2 NC	104370	Ex9CC100 12 3P 400V	1/6
380 V AC	100 A	100	1 NO + 2 NC	104369	Ex9CC100 12 3P 380V	1/6
240 V AC	100 A	100	1 NO + 2 NC	104366	Ex9CC100 12 3P 240V	1/6
<b>230 V AC</b>	<b>100 A</b>	<b>100</b>	<b>1 NO + 2 NC</b>	<b>104365</b>	<b>Ex9CC100 12 3P 230V</b>	<b>1/6</b>
220 V AC	100 A	100	1 NO + 2 NC	104364	Ex9CC100 12 3P 220V	1/6
127 V AC	100 A	100	1 NO + 2 NC	104363	Ex9CC100 12 3P 127V	1/6
110 V AC	100 A	100	1 NO + 2 NC	104362	Ex9CC100 12 3P 110V	1/6
48 V AC	100 A	100	1 NO + 2 NC	104373	Ex9CC100 12 3P 48V	1/6
42 V AC	100 A	100	1 NO + 2 NC	104372	Ex9CC100 12 3P 42V	1/6
36 V AC	100 A	100	1 NO + 2 NC	104368	Ex9CC100 12 3P 36V	1/6
24 V AC	100 A	100	1 NO + 2 NC	104367	Ex9CC100 12 3P 24V	1/6
415 V AC	100 A	100	2 NO + 1 NC	104383	Ex9CC100 21 3P 415V	1/6
400 V AC	100 A	100	2 NO + 1 NC	104382	Ex9CC100 21 3P 400V	1/6
380 V AC	100 A	100	2 NO + 1 NC	104381	Ex9CC100 21 3P 380V	1/6
240 V AC	100 A	100	2 NO + 1 NC	104378	Ex9CC100 21 3P 240V	1/6
<b>230 V AC</b>	<b>100 A</b>	<b>100</b>	<b>2 NO + 1 NC</b>	<b>104377</b>	<b>Ex9CC100 21 3P 230V</b>	<b>1/6</b>
220 V AC	100 A	100	2 NO + 1 NC	104376	Ex9CC100 21 3P 220V	1/6
127 V AC	100 A	100	2 NO + 1 NC	104375	Ex9CC100 21 3P 127V	1/6
110 V AC	100 A	100	2 NO + 1 NC	104374	Ex9CC100 21 3P 110V	1/6
48 V AC	100 A	100	2 NO + 1 NC	104385	Ex9CC100 21 3P 48V	1/6
42 V AC	100 A	100	2 NO + 1 NC	104384	Ex9CC100 21 3P 42V	1/6
36 V AC	100 A	100	2 NO + 1 NC	104380	Ex9CC100 21 3P 36V	1/6
24 V AC	100 A	100	2 NO + 1 NC	104379	Ex9CC100 21 3P 24V	1/6

Main terminals wiring diagram

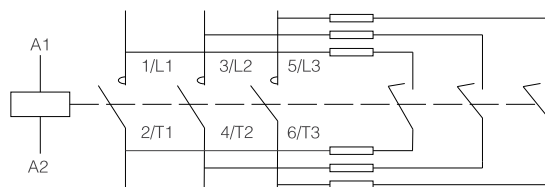

# Notes

A large grid of dashed lines for taking notes, covering most of the page area below the header and above the footer.

# Monitoring relays Ex9JP

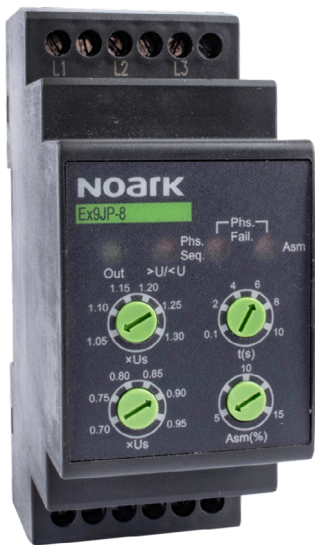

- 3-phase 3-wire or 3-phase 4-wire (with possibility of connection also as 1 or 2 phase)
- Protection against
  - overvoltage
  - undervoltage
  - unbalanced phases
  - phase sequence
  - phase failure
  - overheat
  - load side phase failure
- Delay up to 10 s
- Adjustable or fixed parameters

Monitoring relays Ex9JP are used to provide protection to circuits connected to the power grid. These relays can provide protection against overvoltage, undervoltage, unbalanced phases, phase sequence and phase failure by analyzing voltage on each phase. Temperature control by PTC thermistor in loaded device is optional.

These monitoring relays are provided in various combinations of protective functionalities with fixed or adjustable values.

Common applications are power control systems, air conditioning systems and several motor applications.

### Type Key

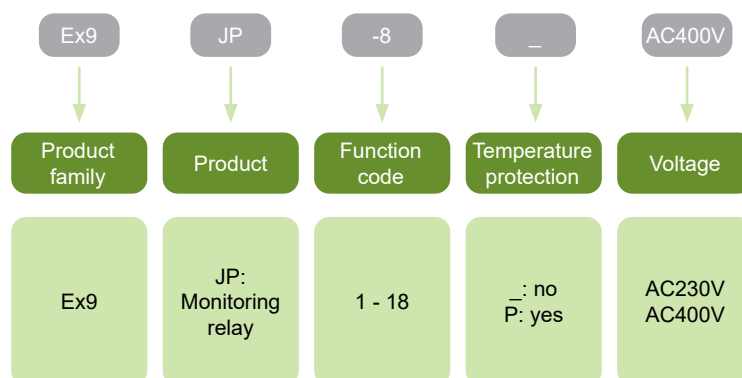

### Certification marks



# Monitoring relays Ex9JP

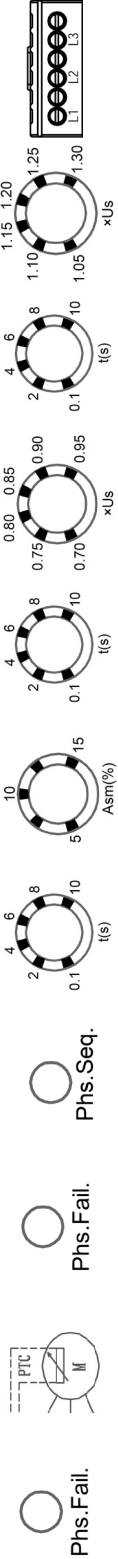

## Ex9JP function codes

Ex9JP		Ex9JP function codes										
Article No.	Type	Load side phase failure protection	Overheat protection	Phase failure protection	Phase sequence protection	Unbalanced phases time-delay [s]	Unbalanced phases protection [%]	Undervoltage time-delay [s]	Undervoltage protection [V]	Overvoltage time-delay [s]	Overvoltage protection [V]	Connection
110230	Ex9JP-1	-	-	■	■	-	-	-	-	-	-	3-phase 3-wire
110231	Ex9JP-1P	-	■	■	■	-	-	-	-	-		
110232	Ex9JP-2	-	-	■	-	-	-	0.1 - 10	(1.05 - 1.3) x U <sub>s</sub>	0.1 - 10		
110233	Ex9JP-3	-	-	■	-	-	-	0.1 - 10	(0.7 - 0.95) x U <sub>s</sub>	-		
110234	Ex9JP-4	-	-	■	-	-	-	0.1 - 10	(0.7 - 0.95) x U <sub>s</sub>	0.1 - 10		
110235	Ex9JP-5	-	-	■	■	-	-	0.1 - 10	(0.7 - 0.95) x U <sub>s</sub>	0.1 - 10		
110236	Ex9JP-6	-	-	■	■	2	20%	0.1 - 10	(0.7 - 0.95) x U <sub>s</sub>	0.1 - 10		
110237	Ex9JP-6P	-	■	■	■	2	20%	0.1 - 10	(0.7 - 0.95) x U <sub>s</sub>	(1.05 - 1.3) x U <sub>s</sub>		
110238	Ex9JP-7	-	-	■	■	0.1 - 10	5% - 15%	2	0.8 x U <sub>s</sub>	1.2 x U <sub>s</sub>		
110239	Ex9JP-7P	-	■	■	■	0.1 - 10	5% - 15%	2	0.8 x U <sub>s</sub>	1.2 x U <sub>s</sub>		
110240	Ex9JP-8	-	-	■	■	0.1 - 10	5% - 15%	0.1 - 10	(0.7 - 0.95) x U <sub>s</sub>	(1.05 - 1.3) x U <sub>s</sub>		

# Monitoring relays Ex9JP

## Ex9JP function codes

110241	110242	110243	110244	110245	110246	110247	110248	110249	110250	110251	110252	110253	110254	110255
Ex9JP-8P	Ex9JP-9	Ex9JP-10	Ex9JP-11	Ex9JP-12	Ex9JP-13	Ex9JP-13P	Ex9JP-14	Ex9JP-14P	Ex9JP-15	Ex9JP-15P	Ex9JP-16	Ex9JP-16P	Ex9JP-17P	Ex9JP-18
3-phase 3-wire		4-wire*						3-phase 4-wire					3-phase 3-wire	
(1.05 - 1.3) x U <sub>s</sub>	(1.05 - 1.3) x U <sub>s</sub>	-	(1.05 - 1.3) x U <sub>s</sub>	(1.05 - 1.3) x U <sub>s</sub>	(1.05 - 1.3) x U <sub>s</sub>	(1.05 - 1.3) x U <sub>s</sub>	1.2 x U <sub>s</sub>	1.2 x U <sub>s</sub>	(1.05 - 1.3) x U <sub>s</sub>	(1.05 - 1.3) x U <sub>s</sub>	-	-	-	(1.05 - 1.3) x U <sub>s</sub>
0.1 - 10	0.1 - 10	-	0.1 - 10	0.1 - 10	0.1 - 10	0.1 - 10	2	2	0.1 - 10	0.1 - 10	-	-	-	2
(0.7 - 0.95) x U <sub>s</sub>	-	(0.7 - 0.95) x U <sub>s</sub>	(0.7 - 0.95) x U <sub>s</sub>	(0.7 - 0.95) x U <sub>s</sub>	(0.7 - 0.95) x U <sub>s</sub>	(0.7 - 0.95) x U <sub>s</sub>	0.8 x U <sub>s</sub>	0.8 x U <sub>s</sub>	(0.7 - 0.95) x U <sub>s</sub>	(0.7 - 0.95) x U <sub>s</sub>	-	-	-	(0.7 - 0.95) x U <sub>s</sub>
0.1 - 10	-	0.1 - 10	0.1 - 10	0.1 - 10	0.1 - 10	0.1 - 10	2	2	0.1 - 10	0.1 - 10	-	-	-	2
5 % - 15 %	-	-	-	-	20 %	20 %	5 % - 15 %	5 % - 15 %	5 % - 15 %	5 % - 15 %	-	-	-	20 %
0.1 - 10	-	-	-	-	2	2	0.1 - 10	0.1 - 10	0.1 - 10	0.1 - 10	-	-	-	2
■	-	-	-	■	■	■	■	■	■	■	■	■	-	■
■	■	■	■	■	■	■	■	■	■	■	■	■	■	■
■	-	-	-	-	-	■	-	■	-	■	-	■	■	-
-	-	-	-	-	-	-	-	-	-	-	-	-	-	■

# Monitoring relays Ex9JP

## Monitoring relays



Connection	PTC protection	Article No.	Type	Packing
3-phase, 3-wire	-	110230	Ex9JP-1 AC400V	1/90
3-phase, 3-wire	yes	110231	Ex9JP-1P AC400V	1/90
3-phase, 3-wire	-	110232	Ex9JP-2 AC400V	1/90
3-phase, 3-wire	-	110233	Ex9JP-3 AC400V	1/90
3-phase, 3-wire	-	110234	Ex9JP-4 AC400V	1/90
3-phase, 3-wire	-	110235	Ex9JP-5 AC400V	1/90
3-phase, 3-wire	-	110236	Ex9JP-6 AC400V	1/90
3-phase, 3-wire	yes	110237	Ex9JP-6P AC400V	1/90
3-phase, 3-wire	-	110238	Ex9JP-7 AC400V	1/90
3-phase, 3-wire	yes	110239	Ex9JP-7P AC400V	1/90
3-phase, 3-wire	-	110240	Ex9JP-8 AC400V	1/90
3-phase, 3-wire	yes	110241	Ex9JP-8P AC400V	1/90
4-wire*	-	110242	Ex9JP-9 AC230V	1/90
4-wire*	-	110243	Ex9JP-10 AC230V	1/90
4-wire*	-	110244	Ex9JP-11 AC230V	1/90
3-phase, 4-wire	-	110245	Ex9JP-12 AC230V	1/90
3-phase, 4-wire	-	110246	Ex9JP-13 AC230V	1/90
3-phase, 4-wire	yes	110247	Ex9JP-13P AC230V	1/90
3-phase, 4-wire	-	110248	Ex9JP-14 AC230V	1/90
3-phase, 4-wire	yes	110249	Ex9JP-14P AC230V	1/90
3-phase, 4-wire	-	110250	Ex9JP-15 AC230V	1/90
3-phase, 4-wire	yes	110251	Ex9JP-15P AC230V	1/90
3-phase, 4-wire	-	110252	Ex9JP-16 AC230V	1/90
3-phase, 4-wire	yes	110253	Ex9JP-16P AC230V	1/90
3-phase, 3-wire	yes	110254	Ex9JP-17P AC400V	1/90
3-phase, 3-wire	-	110255	Ex9JP-18 AC400V	1/90

\* possibility of connection as 3, 2 or 1 phase (see wiring diagrams)

# Monitoring relays Ex9JP

## Monitoring relays

### Wiring diagrams

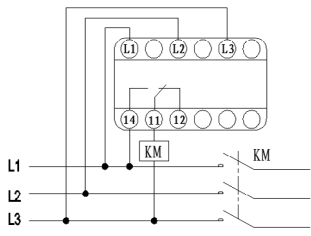

- Ex9JP-1
- Ex9JP-2
- Ex9JP-3
- Ex9JP-4
- Ex9JP-5
- Ex9JP-6
- Ex9JP-7
- Ex9JP-8

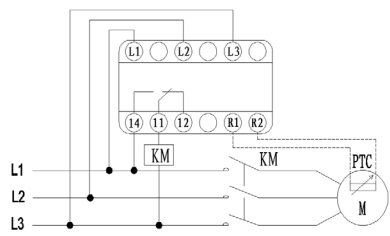

- Ex9JP-1P
- Ex9JP-6P
- Ex9JP-7P
- Ex9JP-8P
- Ex9JP-17P

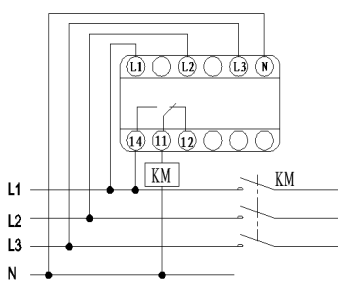

- Ex9JP-12
- Ex9JP-13
- Ex9JP-14
- Ex9JP-15
- Ex9JP-16

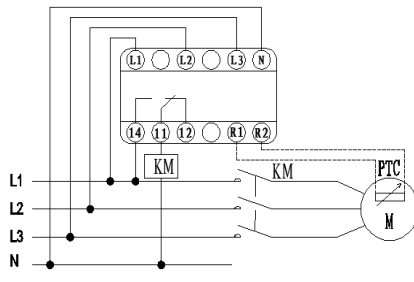

- Ex9JP-13P
- Ex9JP-14P
- Ex9JP-15P
- Ex9JP-16P

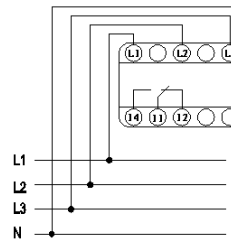

- Ex9JP-9
- Ex9JP-10
- Ex9JP-11

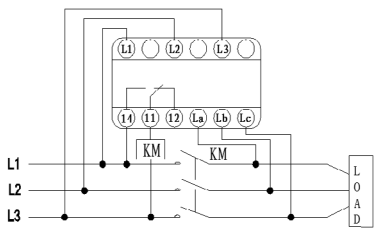

- Ex9JP-18

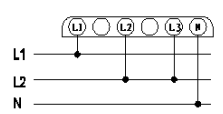

Two phase

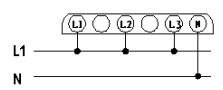

One phase

# Notes

A large grid of dashed lines for taking notes, covering most of the page below the header.



# Plug-in relays Ex9JM



- Meet requirements of IEC / EN 61810-1
- Rated current 3, 5 or 10 A
- Two versions with 2 change-over contacts (5 or 10 A) and version with 4 change-over contact (3 A)
- Plugs and bases offered separately
- Locking button on a plug
- Status indicator

General purpose plug-in relays Ex9JM are suitable for various industrial applications. Reliable and cost effective switching of smaller loads in control circuits is their main usage. Quick installation and easy maintenance make them convenient to use.

AC and DC versions are available with multiple contact configurations. This relay series is available in 12 – 230 V variants of 3, 5 or 10 A rated current — two versions with two change-over contacts (5 or 10 A) and version with four change-over contacts (3 A). Plug and base are sold separately. Locking the relay in one position is enabled by a manually operated locking button on the front side.

## Type Key

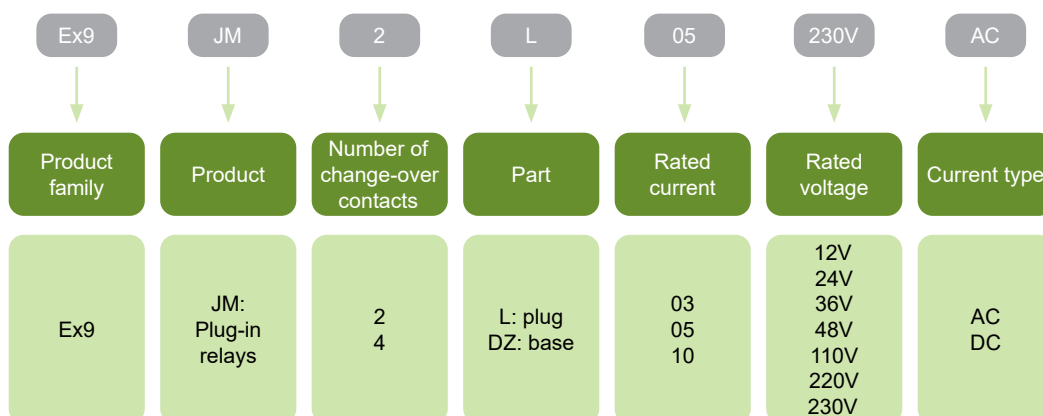

## Certification marks



# Plug-in relays Ex9JM

## Bases, 2 change-over contacts, 10 A



Control voltage	Number of change-over contacts	Rated current	Article No.	Type	Packing
all	2	10 A	110302	Ex9JM2DZ-10	1/10/270

## Plugs, 2 change-over contacts, 10 A



Control voltage	Number of change-over contacts	Rated current	Article No.	Type	Packing
12 V DC	2	10 A	110291	Ex9JM2L10 12VDC	1/20/480
24 V DC	2	10 A	110292	Ex9JM2L10 24VDC	1/20/480
36 V DC	2	10 A	110293	Ex9JM2L10 36VDC	1/20/480
48 V DC	2	10 A	110294	Ex9JM2L10 48VDC	1/20/480
110 V DC	2	10 A	110295	Ex9JM2L10 110VDC	1/20/480
220 V DC	2	10 A	110296	Ex9JM2L10 220VDC	1/20/480
24 V AC	2	10 A	110297	Ex9JM2L10 24VAC	1/20/480
36 V AC	2	10 A	110298	Ex9JM2L10 36VAC	1/20/480
48 V AC	2	10 A	110299	Ex9JM2L10 48VAC	1/20/480
110 V AC	2	10 A	110300	Ex9JM2L10 110VAC	1/20/480
230 V AC	2	10 A	110301	Ex9JM2L10 230VAC	1/20/480

### Wiring diagram

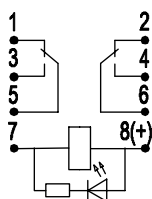

# Plug-in relays Ex9JM

## Bases, 2 change-over contacts, 5 A



Control voltage	Number of change-over contacts	Rated current	Article No.	Type	Packing
all	2	5 A	110314	Ex9JM2DZ-05	1/10/300

## Plugs, 2 change-over contacts, 5 A



Control voltage	Number of change-over contacts	Rated current	Article No.	Type	Packing
12 V DC	2	5 A	110303	Ex9JM2L05 12VDC	1/20/480
24 V DC	2	5 A	110304	Ex9JM2L05 24VDC	1/20/480
36 V DC	2	5 A	110305	Ex9JM2L05 36VDC	1/20/480
48 V DC	2	5 A	110306	Ex9JM2L05 48VDC	1/20/480
110 V DC	2	5 A	110307	Ex9JM2L05 110VDC	1/20/480
220 V DC	2	5 A	110308	Ex9JM2L05 220VDC	1/20/480
24 V AC	2	5 A	110309	Ex9JM2L05 24VAC	1/20/480
36 V AC	2	5 A	110310	Ex9JM2L05 36VAC	1/20/480
48 V AC	2	5 A	110311	Ex9JM2L05 48VAC	1/20/480
110 V AC	2	5 A	110312	Ex9JM2L05 110VAC	1/20/480
230 V AC	2	5 A	110313	Ex9JM2L05 230VAC	1/20/480

### Wiring diagram

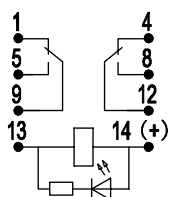

# Plug-in relays Ex9JM

## Bases, 4 change-over contacts, 3 A



Control voltage	Number of change-over contacts	Rated current	Article No.	Type	Packing
all	4	3 A	110326	Ex9JM4DZ-03	1/10/270

## Plugs, 4 change-over contacts, 3 A



Control voltage	Number of change-over contacts	Rated current	Article No.	Type	Packing
12 V DC	4	3 A	110315	Ex9JM4L03 12VDC	1/20/480
24 V DC	4	3 A	110316	Ex9JM4L03 24VDC	1/20/480
36 V DC	4	3 A	110317	Ex9JM4L03 36VDC	1/20/480
48 V DC	4	3 A	110318	Ex9JM4L03 48VDC	1/20/480
110 V DC	4	3 A	110319	Ex9JM4L03 110VDC	1/20/480
220 V DC	4	3 A	110320	Ex9JM4L03 220VDC	1/20/480
24 V AC	4	3 A	110321	Ex9JM4L03 24VAC	1/20/480
36 V AC	4	3 A	110322	Ex9JM4L03 36VAC	1/20/480
48 V AC	4	3 A	110323	Ex9JM4L03 48VAC	1/20/480
110 V AC	4	3 A	110324	Ex9JM4L03 110VAC	1/20/480
230 V AC	4	3 A	110325	Ex9JM4L03 230VAC	1/20/480

### Wiring diagram

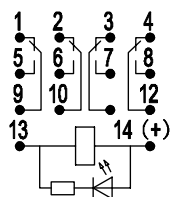

# Motor Protective Circuit Breakers



# Motor protective circuit breakers

## Professional Tips

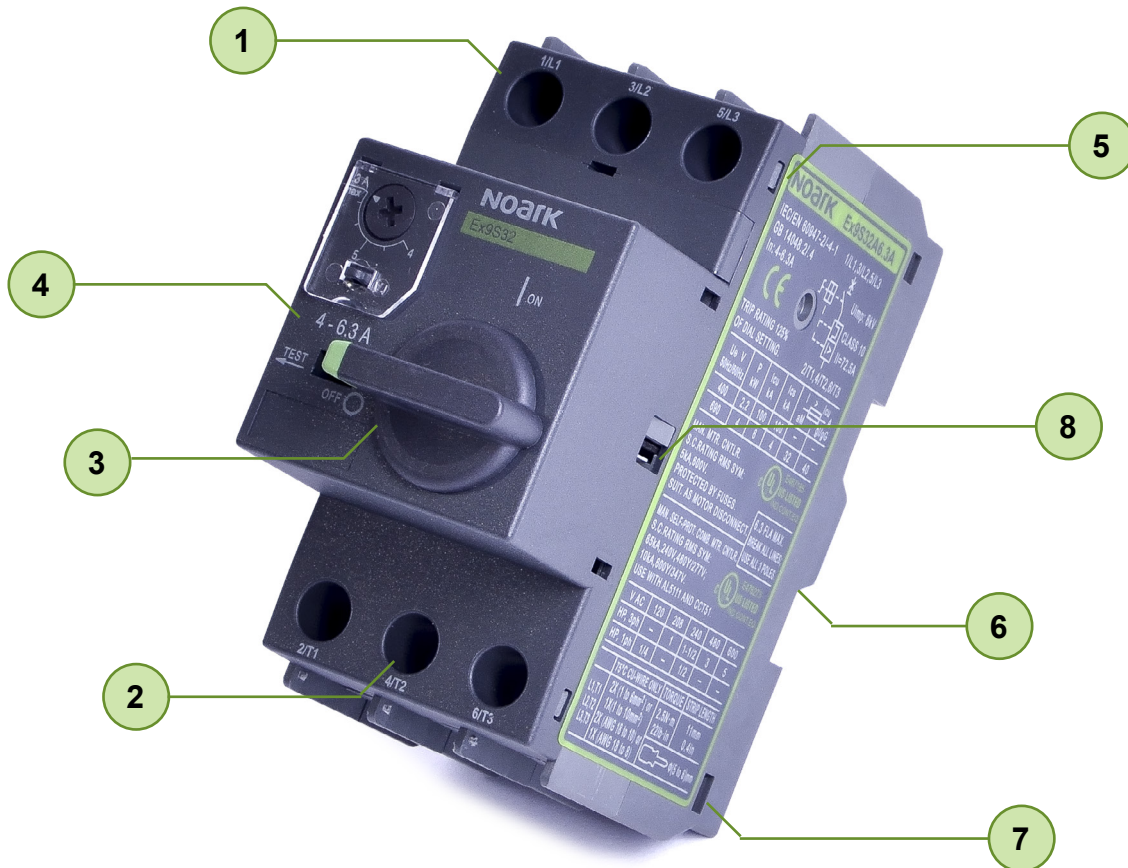

- |   |   |
|---|---|
| <ul style="list-style-type: none"> <li>1 5 year warranty</li> <li>2 Suitable for 1-phase as well 3-phase circuits</li> <li>3 Suitable for residential distribution boards</li> <li>4 Rated current up to 32 A (Ex9S32A), 25 A (Ex9SN25B)</li> </ul> | <ul style="list-style-type: none"> <li>5 Compact dimensions</li> <li>6 Easy mounting on DIN rail</li> <li>7 Wide range of accessories</li> <li>8 Protection against overload, short circuit and phase-loss</li> </ul> |
|---|---|

# Motor protective circuit breakers Ex9S32A



- Manual motor protective circuit breakers
- Meet requirements of IEC/EN 60947-2 and IEC/EN 60947-4-1
- Rated current  $I_n$  up to 32 A at 415 V AC-3
- Rated operating voltage  $U_n$  up to 690V
- Overload, short-circuit and phase-failure protection
- Ambient temperature compensation
- Single frame size suitable also for distribution boards with 45 mm cutout
- Wide range of accessories

Manual motor protective circuit breakers Ex9S32A provide overload, short-circuit and phase-failure protection for the three-phase asynchronous motors with not frequent starting. They are also suitable for power distribution line protection or can be used simply as an isolator.

The right setting of adjustable overload current allows to optimize motor protection by means of circuit breaker. In case of 3P application, correct setting of  $I_r$  provides also protection against overload caused due to a phase lost. Ambient temperature compensation function reduces the impact of ambient temperature. Release testing mechanism enables to test the function of the system and control rotary knob lock mechanism prevents illegal operation.

Motor protective circuit breakers can be combined with wide range of accessories including auxiliary and signal contacts, shunt trip and undervoltage releases. It is possible to create diverse combination of accessories.

## Type Key

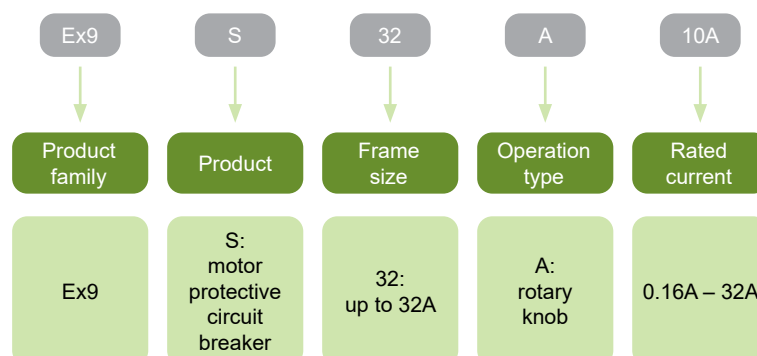

## Certification marks



# Motor protective circuit breakers Ex9S32A

## Accessories

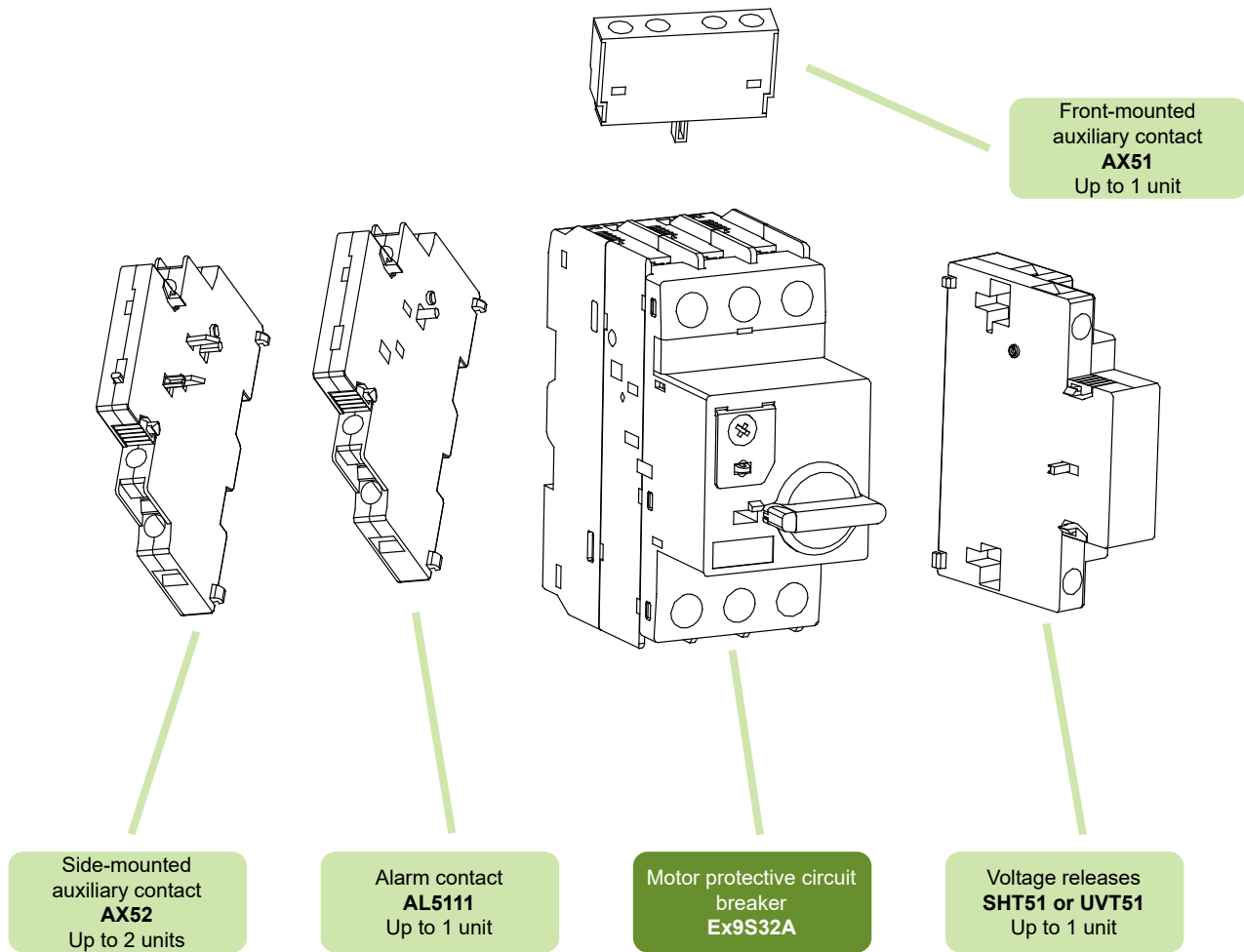

Auxiliary contacts AX51

see page 110

Auxiliary contacts AX52

see page 110

Alarm contact AL5111

see page 110

Shunt trip release SHT51

see page 110

Undervoltage release UVT51

see page 111

Terminal adapters CC5

see page 111

Adapter holder DRA51

see page 111



# Motor protective circuit breakers Ex9S32A

## Motor protective circuit breakers, 3-pole

- Adjustable overload protection  $I_r$
- Fixed instantaneous short-circuit current protection  $I_i$  (ca.  $11 - 14 \times I_e$ )
- Temperature compensation function to reduce the impact of ambient temperature
- Control rotary knob lock mechanism



Rated current $I_e$	Tripping current setting range $I_r$	Short-circuit current $I_i$	Article No.	Type	Packing
0.16 A	0.10 – 0.16 A	2.1 A	108096	Ex9S32A 0.16A	1/30
0.25 A	0.16 – 0.25 A	3.2 A	108097	Ex9S32A 0.25A	1/30
0.40 A	0.25 – 0.40 A	4.8 A	108098	Ex9S32A 0.4A	1/30
0.63 A	0.40 – 0.63 A	7.2 A	108099	Ex9S32A 0.63A	1/30
1.0 A	0.63 – 1.00 A	11 A	108100	Ex9S32A 1A	1/30
1.6 A	1.0 – 1.6 A	20 A	108101	Ex9S32A 1.6A	1/30
2.5 A	1.6 – 2.5 A	30 A	108102	Ex9S32A 2.5A	1/30
4.0 A	2.5 – 4.0 A	50 A	108103	Ex9S32A 4A	1/30
6.3 A	4.0 – 6.3 A	72.5 A	108104	Ex9S32A 6.3A	1/30
10 A	6.0 – 10 A	130 A	108105	Ex9S32A 10A	1/30
14 A	9.0 – 14 A	175 A	108106	Ex9S32A 14A	1/30
18 A	13 – 18 A	230 A	108107	Ex9S32A 18A	1/30
23 A	17 – 23 A	280 A	108108	Ex9S32A 23A	1/30
25 A	20 – 25 A	280 A	108109	Ex9S32A 25A	1/30
32 A	24 – 32 A	416 A	108110	Ex9S32A 32A	1/30

# Notes

A large grid of dashed lines for taking notes, covering most of the page below the 'Notes' header.

# Motor protective circuit breakers Ex9SN25B



- Manual motor protective circuit breakers
- Meet requirements of EN 60947-2 and EN 60947-4-1
- Rated current  $I_n$  up to 25 A at 415 V AC-3
- Rated operating voltage  $U_n$  up to 400/415 V
- Short-circuit protection
- Disconnect function
  - Overload protection
  - Loss-phase protection
- Suitable for three and single-phase applications
- Wide range of accessories

Manual motor starters are electromechanical protection devices for the main circuit. They are used mainly to switch motors manually ON/OFF and protect them fuseless against short circuit and loss-phase.

Fuseless protection with a manual motor starter saves costs, space and ensures a quick reaction under short-circuit condition, by switching off the motor within milliseconds.

Manual motor starter combinations are setup together with contactors and overload relays.

## Type Key

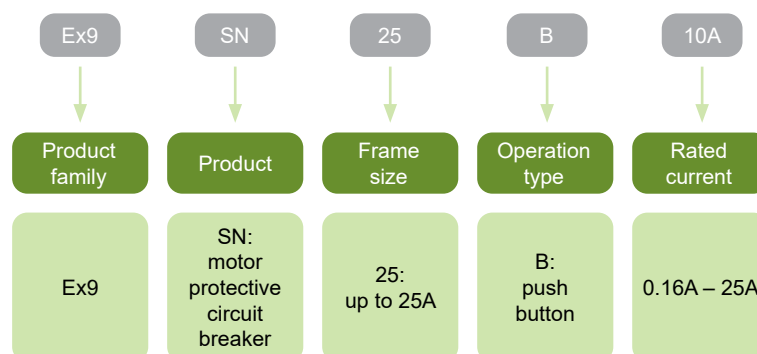

## Certification marks



# Motor protective circuit breakers Ex9SN25B

## Accessories

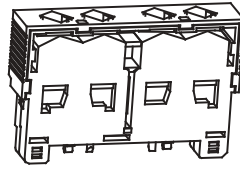

Front-mounted  
auxiliary contact  
**ASNB**  
Up to 1 unit

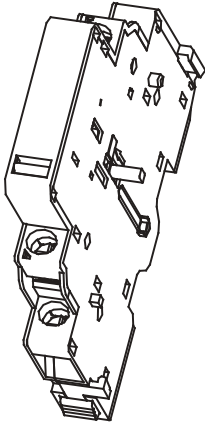

Side-mounted  
auxiliary contact  
**ASNA**  
Up to 2 units

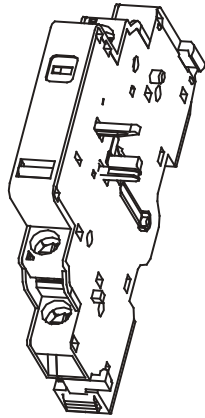

Alarm contact  
**ASNF**  
Up to 1 unit

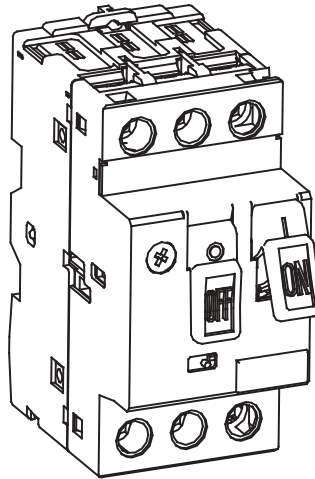

Motor protective  
circuit breaker  
**Ex9SN25B**

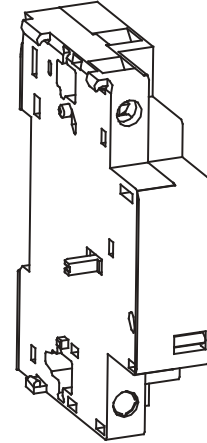

Voltage releases  
**ASNT or ASNUV**  
Up to 1 unit

Auxiliary contacts ASNA

see page 113

Auxiliary contacts ASNB

see page 113

Alarm contact ASNF

see page 113

Shunt trip release ASNT

see page 115

Undervoltage release ASNUV

see page 115

Isolated boxes for surface mounting ASNE

see page 115

# Motor protective circuit breakers Ex9SN25B

## Motor protective circuit breakers, 3-pole

- Adjustable overload protection  $I_r$
- Fixed instantaneous short-circuit current protection  $I_i$  (ca.  $11 - 14 \times I_n$ )
- Temperature compensation function to reduce the impact of ambient temperature



Rated current $I_n$	Tripping current setting range $I_r$	Short-circuit current $I_i$	Article No.	Type	Packing
0.16 A	0.10 – 0.16 A	1.5 A	108940	Ex9SN25B 0.16A	1/64
0.25 A	0.16 – 0.25 A	2.4 A	108941	Ex9SN25B 0.25A	1/64
0.40 A	0.25 – 0.40 A	5 A	108942	Ex9SN25B 0.4A	1/64
0.63 A	0.40 – 0.63 A	8 A	108943	Ex9SN25B 0.63A	1/64
1.0 A	0.63 – 1.00 A	13 A	108944	Ex9SN25B 1A	1/64
1.6 A	1.0 – 1.6 A	22.5 A	108945	Ex9SN25B 1.6A	1/64
2.5 A	1.6 – 2.5 A	33.5 A	108946	Ex9SN25B 2.5A	1/64
4.0 A	2.5 – 4.0 A	51 A	108947	Ex9SN25B 4A	1/64
6.3 A	4.0 – 6.3 A	78 A	108948	Ex9SN25B 6.3A	1/64
10 A	6.0 – 10 A	138 A	108949	Ex9SN25B 10A	1/64
14 A	9.0 – 14 A	170 A	108950	Ex9SN25B 14A	1/64
18 A	13 – 18 A	223 A	108951	Ex9SN25B 18A	1/64
23 A	17 – 23 A	327 A	108952	Ex9SN25B 23A	1/64
25 A	20 – 25 A	327 A	108953	Ex9SN25B 25A	1/64

# Notes

A large grid of dashed lines for taking notes, covering the majority of the page below the 'Notes' header.

# Overload Thermal Relays



# Overload thermal relays

## Professional Tips

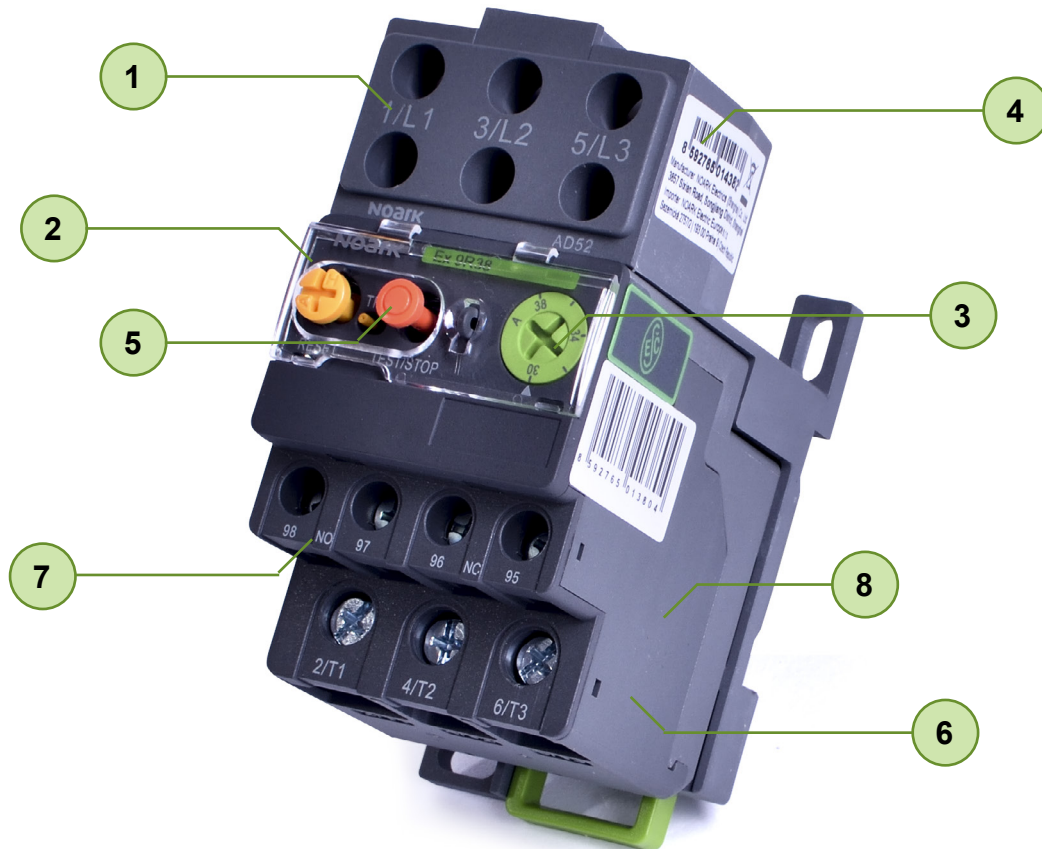

- 1 5 year warranty
- 2 Five frame sizes
- 3 Rate current up to 500 A
- 4 Direct mounting onto Ex9C(S) or stand alone
- 5 Automatic and manual reset function
- 6 Tripping class 10A
- 7 Integrated 1NO and 1NC contact
- 8 Motor protection against overload or phase lost



# Overload thermal relays Ex9R



- Overload thermal relays according to IEC / EN 60947-4-1
- Three frame sizes with rated current up to 100 A at 690 V AC-3
- 3-pole versions
- Tripping class 10A
- For direct mounting onto Ex9C(S) contactors series or as a stand-alone device
- Suitable mainly for motor protection against overload or phase lost
- Mounting onto connected contactor or onto device rail (DIN) 35 mm by means of AD5. adaptor

Ex9R overload thermal relays contactors are designed for protection of motors mainly. These relays can be either combined directly with contactors of Ex9CS and Ex9C series or used as a stand-alone device with AD5 adaptor. Relays are available in three frame sizes for rated non-reduced currents from 0.16 — 100 A.

Size Ex9R12 is designed to match miniature contactors Ex9CS. Version Ex9R38 can be mounted onto contactors Ex9C18 and with spacer (in the scope of delivery of the relay) also with size Ex9C38. The last size Ex9R100 can be combined with Ex9C65 and Ex9C100 directly.

Ex9R relays are equipped with 1 NO and 1 NC auxiliary contacts.

## Type Key

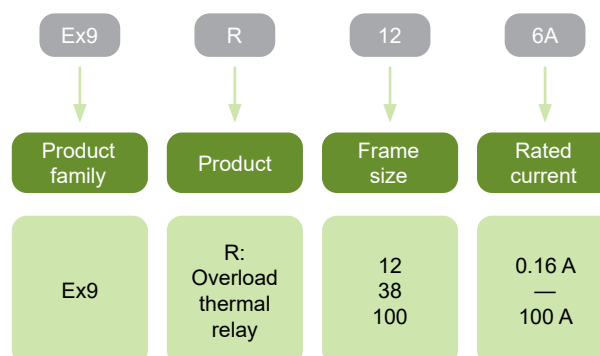

## Certification marks



# Overload thermal relays Ex9R

## Design



**Ex9R12**  
Frame size 12



**Ex9R38**  
Frame size 38



**Ex9R100**  
Frame size 100

## Mounting



Direct mounting  
onto contactor



Adaptor AD5.



Stand-alone device  
with adaptor AD5.

# Overload thermal relays Ex9R

## Frame size 12

- Overload thermal relays
- For direct mounting onto Miniature Contactors Ex9CS
- Stand-alone device for mounting onto device (DIN) rail 35 mm by means of combination with adaptor AD51
- Automatic and manual reset function
- Tripping class 10A



Current setting range $I_n$	For contactor frame size	Poles	Auxiliary contacts	Article No.	Type	Packing
0.1 - 0.16 A	Mini (S06, S09, S12)	3	1 NO + 1 NC	101359	Ex9R12 0.16A	1/80
0.16 - 0.25 A	Mini (S06, S09, S12)	3	1 NO + 1 NC	101360	Ex9R12 0.25A	1/80
0.25 - 0.4 A	Mini (S06, S09, S12)	3	1 NO + 1 NC	101361	Ex9R12 0.4A	1/80
0.4 - 0.63 A	Mini (S06, S09, S12)	3	1 NO + 1 NC	101362	Ex9R12 0.63A	1/80
0.63 - 1 A	Mini (S06, S09, S12)	3	1 NO + 1 NC	101363	Ex9R12 1A	1/80
1 - 1.6 A	Mini (S06, S09, S12)	3	1 NO + 1 NC	101364	Ex9R12 1.6A	1/80
1.6 - 2.5 A	Mini (S06, S09, S12)	3	1 NO + 1 NC	101365	Ex9R12 2.5A	1/80
2.5 - 4 A	Mini (S06, S09, S12)	3	1 NO + 1 NC	101366	Ex9R12 4A	1/80
4 - 6 A	Mini (S06, S09, S12)	3	1 NO + 1 NC	101367	Ex9R12 6A	1/80
5.5 - 8 A	Mini (S06, S09, S12)	3	1 NO + 1 NC	101368	Ex9R12 8A	1/80
7 - 10 A	Mini (S06, S09, S12)	3	1 NO + 1 NC	101369	Ex9R12 10A	1/80
9 - 12 A	Mini (S06, S09, S12)	3	1 NO + 1 NC	101370	Ex9R12 12A	1/80

### Wiring diagram

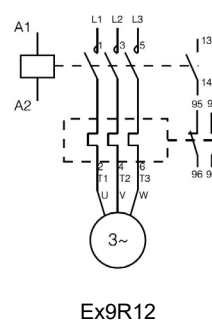
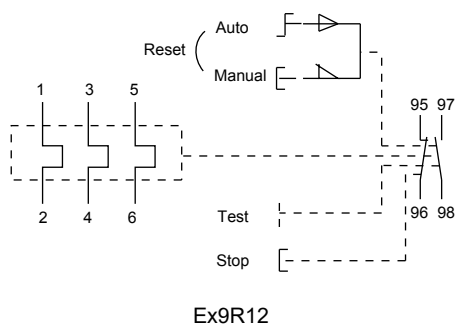

# Overload thermal relays Ex9R

## Frame size 38

- Overload thermal relays
- For direct mounting onto Contactors Ex9C09 to Ex9C38 (with included spacer)
- Stand-alone device for mounting onto device (DIN) rail 35 mm by means of combination with adaptor AD56
- Automatic and manual reset function
- Tripping class 10A



Current setting range $I_n$	For contactor frame size	Poles	Auxiliary contacts	Article No.	Type	Packing
0.63 - 1A	18 (09, 12, 18), 38 (25, 32, 38)	3	1 NO + 1 NC	110327	Ex9R38B 1A	1/60
1 - 1.6A	18 (09, 12, 18), 38 (25, 32, 38)	3	1 NO + 1 NC	110328	Ex9R38B 1.6A	1/60
1.6 - 2.5A	18 (09, 12, 18), 38 (25, 32, 38)	3	1 NO + 1 NC	110329	Ex9R38B 2.5A	1/60
2.5 - 4 A	18 (09, 12, 18), 38 (25, 32, 38)	3	1 NO + 1 NC	110330	Ex9R38B 4A	1/60
4 - 6 A	18 (09, 12, 18), 38 (25, 32, 38)	3	1 NO + 1 NC	110331	Ex9R38B 6A	1/60
5.5 - 8 A	18 (09, 12, 18), 38 (25, 32, 38)	3	1 NO + 1 NC	110332	Ex9R38B 8A	1/60
7 - 10 A	18 (09, 12, 18), 38 (25, 32, 38)	3	1 NO + 1 NC	110333	Ex9R38B 10A	1/60
9 - 13 A	18 (09, 12, 18), 38 (25, 32, 38)	3	1 NO + 1 NC	110334	Ex9R38B 13A	1/60
12 - 18 A	18 (09, 12, 18), 38 (25, 32, 38)	3	1 NO + 1 NC	110335	Ex9R38B 18A	1/60
16 - 24 A	18 (09, 12, 18), 38 (25, 32, 38)	3	1 NO + 1 NC	110336	Ex9R38B 24A	1/60
23 - 32 A	18 (09, 12, 18), 38 (25, 32, 38)	3	1 NO + 1 NC	110337	Ex9R38B 32A	1/60
30 - 38 A	18 (09, 12, 18), 38 (25, 32, 38)	3	1 NO + 1 NC	110338	Ex9R38B 38A	1/60

### Wiring diagram

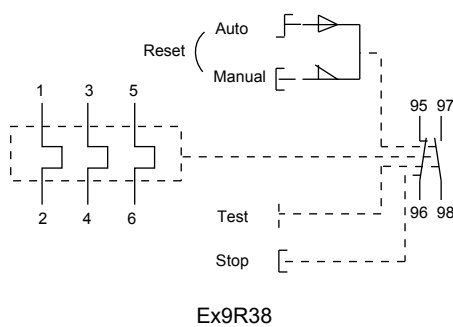

Ex9R38

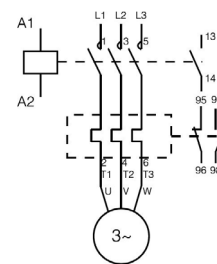

Ex9R38

# Overload thermal relays Ex9R

## Frame size 100

- Overload thermal relays
- For direct mounting onto Contactors Ex9C65 and Ex9C100 (with included spacer)
- Stand-alone device for mounting onto device (DIN) rail 35 mm by means of combination with adaptor AD53
- Automatic and manual reset function
- Tripping class 10A



Current setting range $I_e$	For contactor frame size	Poles	Auxiliary contacts	Article No.	Type	Packing
23 - 32 A	65 (40, 50, 65), 100 (80, 100)	3	1 NO + 1 NC	101380	Ex9R100 32A	1/24
30 - 40 A	65 (40, 50, 65), 100 (80, 100)	3	1 NO + 1 NC	101381	Ex9R100 40A	1/24
37 - 50 A	65 (40, 50, 65), 100 (80, 100)	3	1 NO + 1 NC	101382	Ex9R100 50A	1/24
48 - 65 A	65 (40, 50, 65), 100 (80, 100)	3	1 NO + 1 NC	101383	Ex9R100 65A	1/24
55 - 70 A	65 (40, 50, 65), 100 (80, 100)	3	1 NO + 1 NC	101384	Ex9R100 70A	1/24
63 - 80 A	65 (40, 50, 65), 100 (80, 100)	3	1 NO + 1 NC	101385	Ex9R100 80A	1/24
80 - 100 A	65 (40, 50, 65), 100 (80, 100)	3	1 NO + 1 NC	101386	Ex9R100 100A	1/24

### Wiring diagram

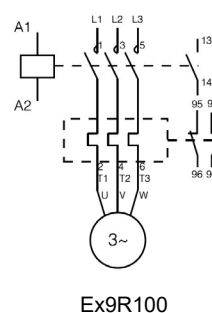
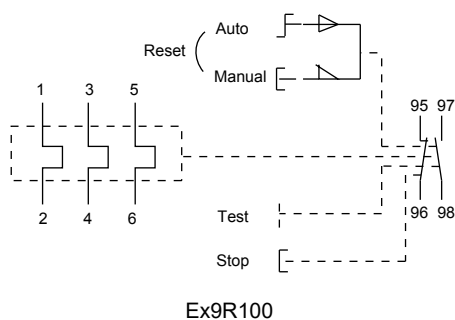

# Notes

A large grid of dashed lines for taking notes, covering the majority of the page area below the 'Notes' header.

# Overload thermal relays Ex9R up to 500 A



- Overload thermal relays according to IEC / EN 60947-4-1
- Two frame sizes with rated current up to 500 A at 690 V AC-3
- 3-pole versions
- Tripping class 10A
- For direct mounting onto Ex9C contactors or as a stand-alone device with AD adaptor
- Suitable mainly for motor protection against overload or phase lost

Ex9R overload thermal relays contactors are designed for protection of motors mainly. These relays can be either combined directly with contactors of Ex9C115-500 series or used as a stand-alone device with AD5 adaptor. Relays are available in two frame sizes for rated non-reduced currents from 80 — 500 A.

Size Ex9R185 is designed to match contactors of frame size 185 (Ex9C115-185). Version Ex9R500 can be mounted onto contactors of 300 (Ex9C225-300) frame size and also with size 500 (Ex9C400-500).

Ex9R relays are equipped with 1 NO and 1 NC auxiliary contacts as the standard.

## Type Key

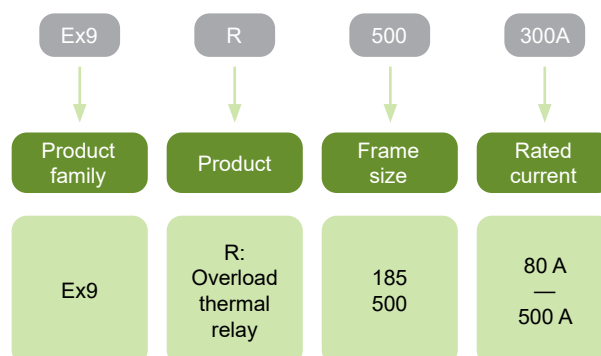

## Certification marks



# Overload thermal relays Ex9R up to 500 A

## Design



**Ex9R185**  
Frame size 185



**Ex9R500**  
Frame size 500

## Mounting



Direct mounting  
onto Ex9C contactor



Stand-alone device  
with adaptor AD5.



# Overload thermal relays Ex9R up to 500 A

## Frame size 185

- Overload thermal relays
- For direct mounting onto Ex9C115-185 contactors
- Stand-alone device for mounting onto panel by means of combination with adaptor AD54
- Automatic and manual reset function
- Tripping class 10A



Current setting range $I_n$	For contactors of frame size	Poles	Auxiliary contacts	Article No.	Type	Packing
80 - 115 A	185 (115, 165, 185)	3P	1 NO + 1 NC	106326	Ex9R185 115A	1/8
110 - 150 A	185 (115, 165, 185)	3P	1 NO + 1 NC	106327	Ex9R185 150A	1/8
140 - 185 A	185 (115, 165, 185)	3P	1 NO + 1 NC	106328	Ex9R185 185A	1/8

## Frame size 500

- Overload thermal relays
- For direct mounting onto Ex9C225-500 contactors
- Stand-alone device for mounting onto panel by means of combination with adaptor AD55
- Automatic and manual reset function
- Tripping class 10A



Current setting range $I_n$	For contactors of frame size	Poles	Auxiliary contacts	Article No.	Type	Packing
160 - 225 A	300 (225, 265, 300) 500 (400, 500)	3P	1 NO + 1 NC	106329	Ex9R500 225A	1/8
210 - 300 A	300 (225, 265, 300) 500 (400, 500)	3P	1 NO + 1 NC	106330	Ex9R500 300A	1/8
280 - 400 A	300 (225, 265, 300) 500 (400, 500)	3P	1 NO + 1 NC	106331	Ex9R500 400A	1/8
380 - 500 A	300 (225, 265, 300) 500 (400, 500)	3P	1 NO + 1 NC	106332	Ex9R500 500A	1/8

### Wiring diagram

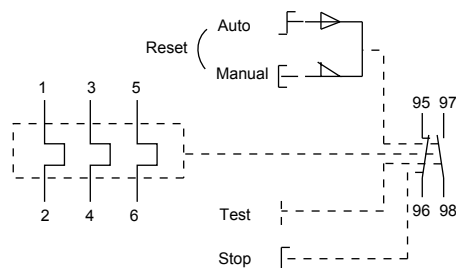

# Notes

A large grid of dashed lines for taking notes, covering most of the page area below the header.

# Accessories for Industrial Devices



# Accessories for Industrial Devices

## Professional Tips



- 1 5 year warranty
- 2 Various auxiliary contacts combination
- 3 Different types of releases
- 4 Robust construction
- 5 Easy mounting
- 6 Wide range of accessories

# Accessories for contactors



- Accessories for contactors of line Ex9CS, Ex9CSR, Ex9C, Ex9CR, Ex9C500 and Ex9CC
- Front-mounted auxiliary contacts AX41/42
- Side-mounted auxiliary contacts AX43/44
- Pneumatic time delay blocks TDD4
- Surge suppressor blocks CCU4
- Mechanical interlocks MIT4
- Connection set PCL for reversible combination

AX41 auxiliary contact units and CCU41 surge suppressor blocks are designed in order to match miniature version of contactors Ex9CS or Ex9CSR. Auxiliary contact units are available with four contacts with all possible contact combinations.

Contactors Ex9C line (Ex9C, Ex9CR) share accessories, i.e. available portfolio can be used for all sizes of contactors (except miniature ones). Every contactor can be equipped with one front-mounted unit (AX42 or TDD4), two units of side-mounted contact AX43/44 (one from the left, the other from the right) and surge suppressor block CCU42/43. Installation of an front-mounted unit does not affect a possibility to install overload thermal relay Ex9R.

Capacitor contactors Ex9CC can be equipped with two units of side-mounted contact AX4311 (one from the left, the other from the right) and surge suppressor block CCU42/43.

## Type Key

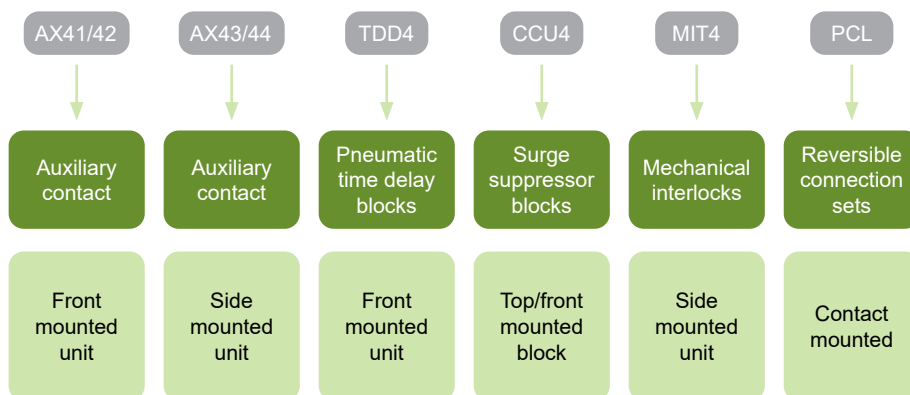

# Accessories for contactors

Miniature Contactors Ex9CS

Miniature Reversible Contactors Ex9CSR

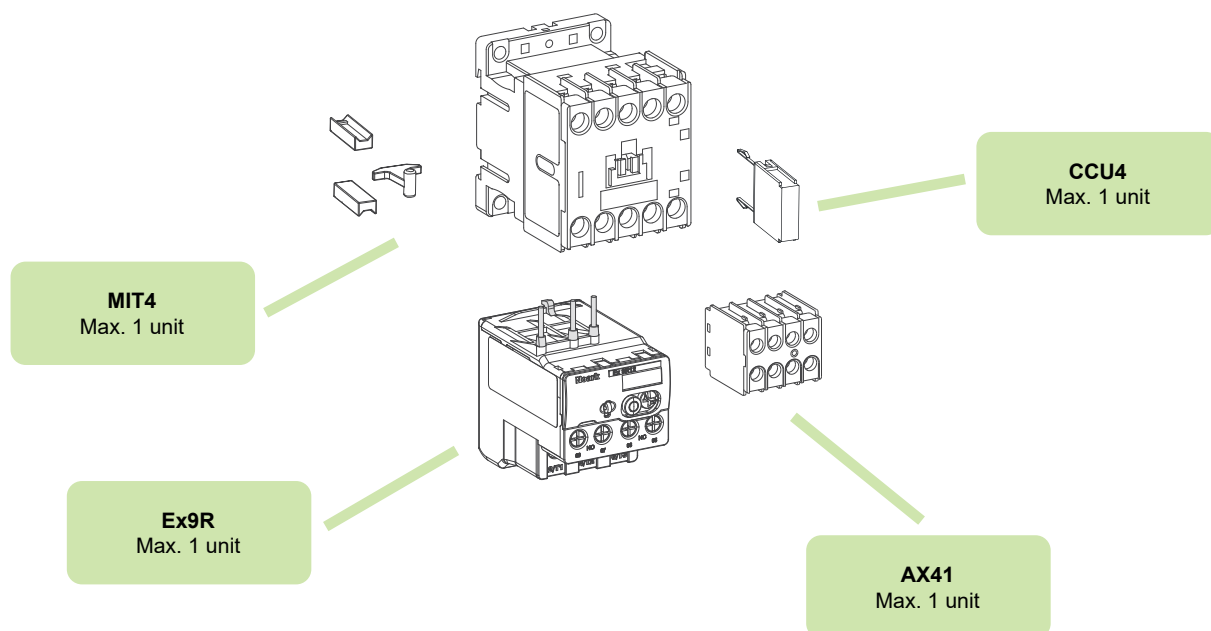

# Accessories for contactors

Contactors Ex9C, Ex9C500

Reversible contactors Ex9CR

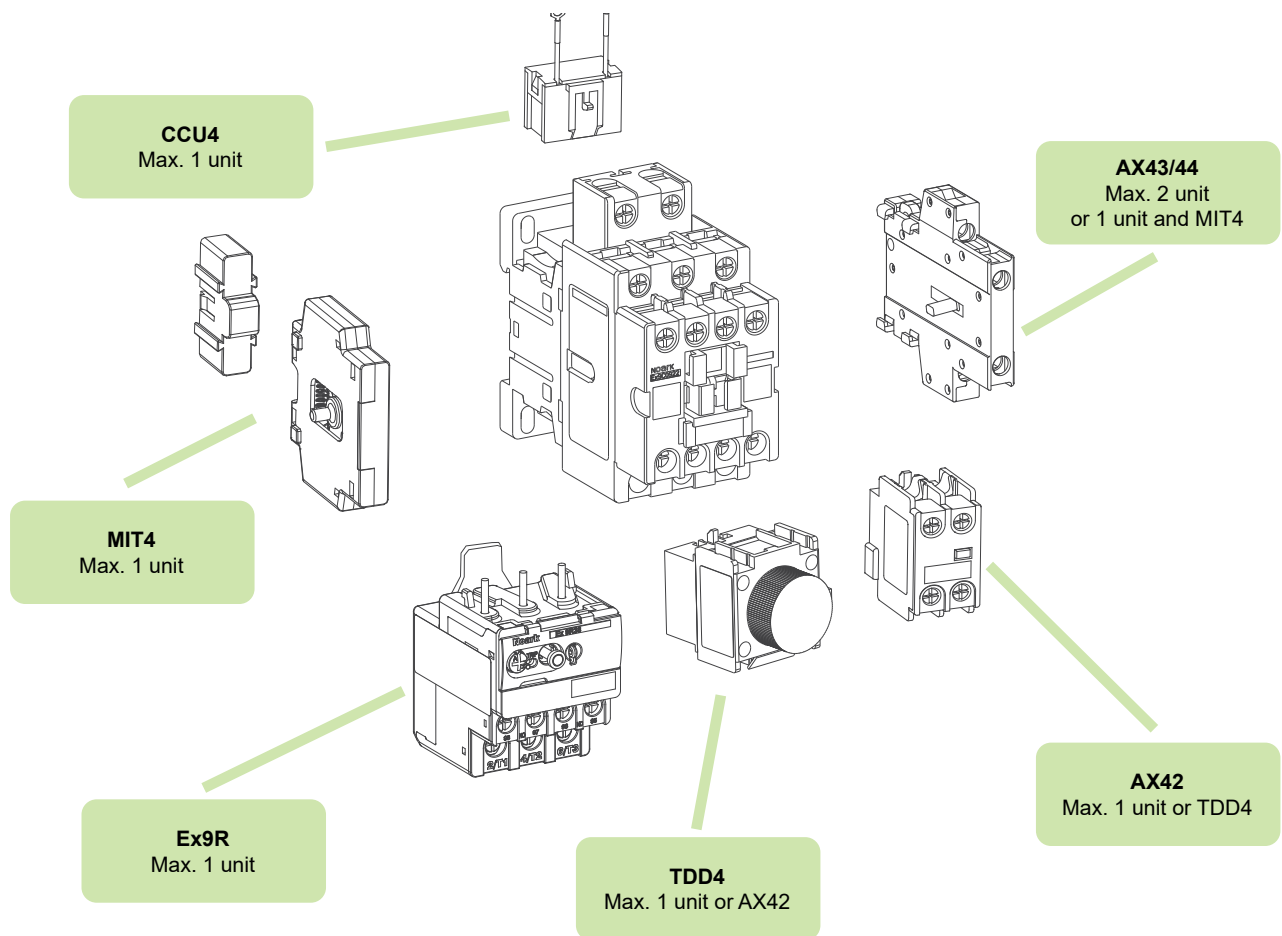

# Accessories for contactors

## Capacitor Contactors Ex9CC

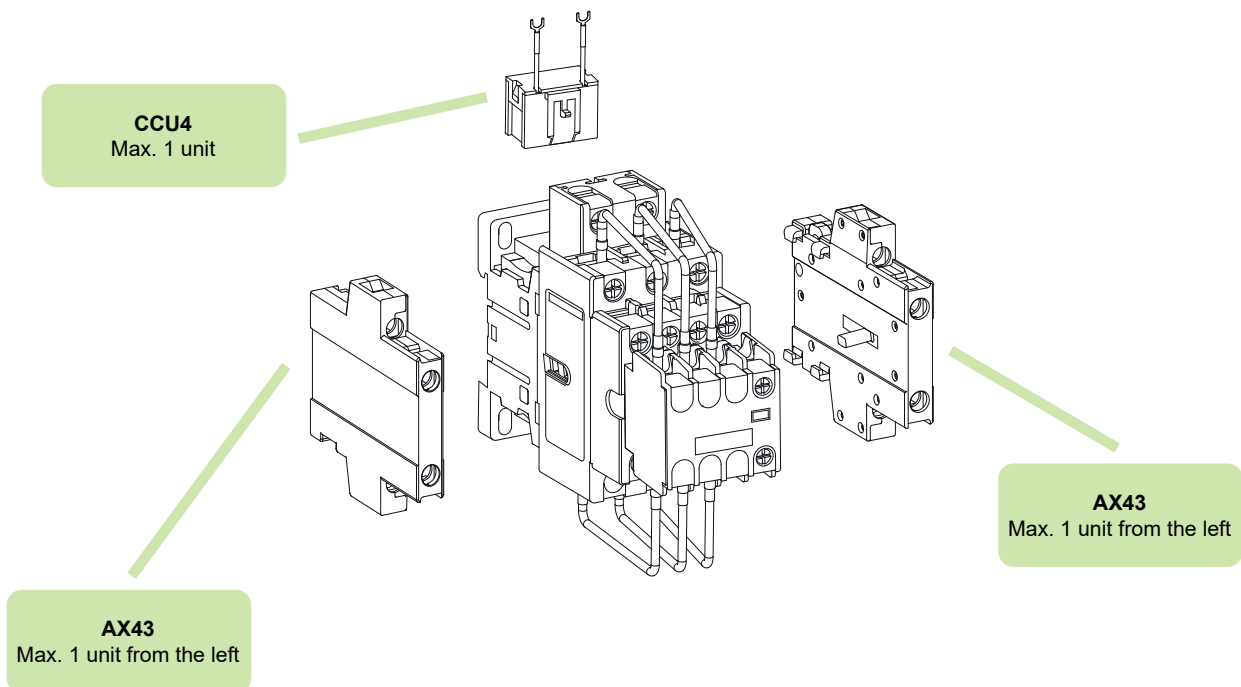



# Accessories for contactors

## Auxiliary contacts for Ex9CS line miniature contactors, front-mounted

- Auxiliary contacts for miniature contactors line Ex9CS and Ex9CSR
- For subsequent mounting
- Front-mounted version
- 1 unit can be used with a contactor
- Do not limit the possibility of installing overload thermal relays Ex9R12



Contacts	Suitable for	Article No.	Type	Packing
4 NC	Ex9CS, Ex9CSR	101435	AX4104	6/216
1 NO + 3 NC	Ex9CS, Ex9CSR	101280	AX4113	6/216
2 NO + 2 NC	Ex9CS, Ex9CSR	101281	AX4122	6/216
3 NO + 1 NC	Ex9CS, Ex9CSR	101282	AX4131	6/216
4 NO	Ex9CS, Ex9CSR	101283	AX4140	6/216

### Wiring diagrams

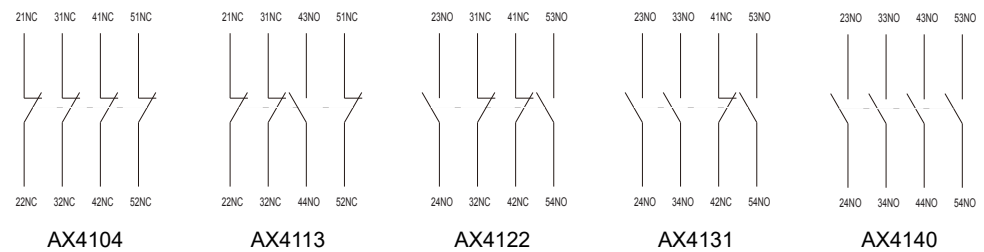

# Accessories for contactors

## Auxiliary contacts for contactors, front-mounted

- Auxiliary contacts for contactors line Ex9C, Ex9CR up to 500 A
- For subsequent mounting
- Front-mounted version
- 1 unit or TDD4 unit can be used with a contactor
- Do not limit the possibility of installing overload thermal relays Ex9R



Contacts	Suitable for	Article No.	Type	Packing
2 NC	Ex9C, Ex9CR	101284	AX4202	12/624
1 NO + 1 NC	Ex9C, Ex9CR	101285	AX4211	12/624
2 NO	Ex9C, Ex9CR	101286	AX4220	12/624
4 NC	Ex9C, Ex9CR	101287	AX4204	6/312
1 NO + 3 NC	Ex9C, Ex9CR	101288	AX4213	6/312
2 NO + 2 NC	Ex9C, Ex9CR	101289	AX4222	6/312
3 NO + 1 NC	Ex9C, Ex9CR	101290	AX4231	6/312
4 NO	Ex9C, Ex9CR	101291	AX4240	6/312

### Wiring diagrams

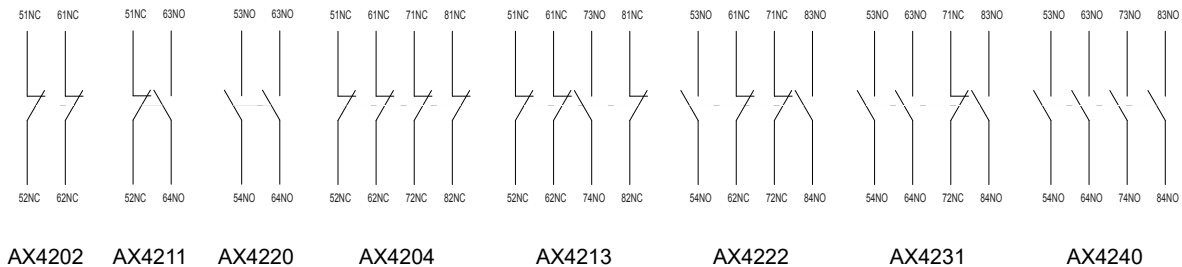

Technical data p. 218

## Auxiliary contacts for Ex9C line contactors, side-mounted

- Auxiliary contacts for contactors line Ex9C, Ex9CR up to 100 A
- For subsequent mounting
- Side-mounted version
- 1 unit can be used with a contactor at the left, another unit at the right
- Do not limit the possibility of installing front mounted auxiliary contacts AX42/TDD4 or overload thermal relays Ex9R



Contacts	Suitable for	Article No.	Type	Packing
1 NO + 1 NC	Ex9C, Ex9CR	101292	AX4311	10/120

### Wiring diagram

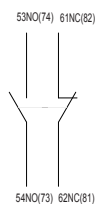

AX4311

Technical data p. 218

# Accessories for contactors

## Auxiliary contacts for C500 line contactors, side-mounted

- Auxiliary contacts for contactors line Ex9C115-500
- For subsequent mounting
- Side-mounted version
- 1 unit can be used with a contactor at the left, another unit at the right side
- Do not limit the possibility of installing front-mounted auxiliary contacts AX42 or overload thermal relays Ex9R185, Ex9R500



Contacts	Suitable for	Article No.	Type	Packing
1 NO + 1 NC	Ex9C115-500	106322	AX4411	1/12/144
2 NO	Ex9C115-500	107958	AX4420	1/12/144
2 NC	Ex9C115-500	107957	AX4402	1/12/144

### Wiring diagrams

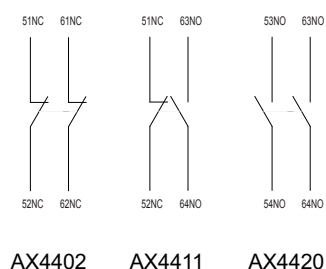

Technical data p. 225

## Mechanical interlocks for Ex9C line contactors, side-mounted

- Mechanical interlock set for connecting of two contactors line Ex9C allows that only one contactor is switched at a given moment
- For subsequent mounting
- 1 unit can be used together with two contactors of the same frame size
- Limit using of side-mounted auxiliary contact unit AX43/44, do not limit the possibility of installing front-mounted auxiliary contacts AX42 or overload thermal relays Ex9R



Description	Suitable for	Article No.	Type	Packing
Mechanical interlock	Ex9CS	107959	MIT41	1 set
Mechanical interlock	Ex9C09-38 11	107960	MIT42-11	1 set
Mechanical interlock	Ex9C09-38 22	108095	MIT42-22	1 set
Mechanical interlock	Ex9C40-100	107961	MIT43	1 set
Mechanical interlock	Ex9C115-185	107962	MIT44	1 set
Mechanical interlock	Ex9C225-300	107963	MIT45	1 set
Mechanical interlock	Ex9C400-500	107964	MIT46	1 set

## Connection sets for reversible combination of Ex9C line contactors

- Connection set for reversible combination of two contactors line Ex9C115-500
- For subsequent mounting
- 1 unit can be used together with two contactors of the same frame size
- Do not limit the possibility of installing front-mounted auxiliary contacts AX42 or overload thermal relays Ex9R



Description	Suitable for	Article No.	Type	Packing
Connection set	Ex9C115-185	107965	PCL185	1 set
Connection set	Ex9C225-300	107966	PCL300	1 set
Connection set	Ex9C400-500	107967	PCL500	1 set

# Accessories for contactors

## Pneumatic time delay blocks

- For delayed closing or delayed opening of internal 1 NO + 1 NC auxiliary contacts
- Suitable for contactors of Ex9C, Ex9CR up to 500 A
- For subsequent mounting
- Front mounted
- 1 unit or AX42 unit can be used with a contactor
- Do not limit the possibility of installing overload thermal relays Ex9R



Delay type	Delay range	Article No.	Type	Packing
ON delay	0.1 - 3 s	104494	TDD41A	1/72
ON delay	0.1 - 30 s	104493	TDD41B	1/72
ON delay	10 - 180 s	104492	TDD41C	1/72
OFF delay	0.1 - 3 s	104491	TDD42A	1/72
OFF delay	0.1 - 30 s	104490	TDD42B	1/72
OFF delay	10 - 180 s	104489	TDD42C	1/72

Technical data p. 222

## Surge suppressor blocks

- Reduces voltage peaks in control circuit
- Versions with varistor (CCU 41) and RC circuit technology (CCU 42, CCU 43)
- Includes cable lugs for connecting to contactor terminals
- For subsequent mounting
- Front/top mounted
- 1 unit unit can be used with a contactor
- Do not limit the possibility of installing front mounted auxiliary contacts AX42/TDD4 or overload thermal relays Ex9R



Protection range	Suitable for	Article No.	Type	Packing
380-415 V	Ex9CS06-12	104502	CCU41 415	1/10
110-240 V	Ex9CS06-12	104503	CCU41 240	1/10
24-48 V	Ex9CS06-12	104501	CCU41 48	1/10
380-415 V	Ex9C09-38, Ex9CC09-38	104499	CCU42 415	1/10
110-240 V	Ex9C09-38, Ex9CC09-38	104500	CCU42 240	1/10
24-48 V	Ex9C09-38, Ex9CC09-38	104498	CCU42 48	1/10
380-415 V	Ex9C40-100, Ex9CC50-100	104496	CCU43 415	1/4
110-240 V	Ex9C40-100, Ex9CC50-100	104497	CCU43 240	1/4
24-48 V	Ex9C40-100, Ex9CC50-100	104495	CCU43 48	1/4

Technical data p. 224

# Accessories for contactors

## Spare control coils for Ex9C500 line contactors

- Spare control coils for contactors line Ex9C115-500
- Replaces the coil supplied in contactor
- Including holder
- Packed separately

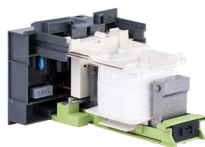

Description	Suitable for	Control voltage	Article No.	Type	Packing
Spare control coil	Ex9C185	415 V AC/DC	107986	ECC44 415V AC/DC	1
Spare control coil	Ex9C185	400 V AC/DC	107985	ECC44 400V AC/DC	1
Spare control coil	Ex9C185	380 V AC/DC	107984	ECC44 380V AC/DC	1
Spare control coil	Ex9C185	240 V AC/DC	107983	ECC44 240V AC/DC	1
Spare control coil	Ex9C185	230 V AC/DC	107982	ECC44 230V AC/DC	1
Spare control coil	Ex9C185	220 V AC/DC	107981	ECC44 220V AC/DC	1
Spare control coil	Ex9C185	127 V AC/DC	107980	ECC44 127V AC/DC	1
Spare control coil	Ex9C185	110 V AC/DC	107979	ECC44 110V AC/DC	1
Spare control coil	Ex9C185	48 V AC/DC	107978	ECC44 48V AC/DC	1
Spare control coil	Ex9C185	42 V AC/DC	107977	ECC44 42V AC/DC	1
Spare control coil	Ex9C185	36 V AC/DC	107976	ECC44 36V AC/DC	1
Spare control coil	Ex9C185	24 V AC/DC	107975	ECC44 24V AC/DC	1
Spare control coil	Ex9C300	415 V AC/DC	107998	ECC45 415V AC/DC	1
Spare control coil	Ex9C300	400 V AC/DC	107997	ECC45 400V AC/DC	1
Spare control coil	Ex9C300	380 V AC/DC	107996	ECC45 380V AC/DC	1
Spare control coil	Ex9C300	240 V AC/DC	107995	ECC45 240V AC/DC	1
Spare control coil	Ex9C300	230 V AC/DC	107994	ECC45 230V AC/DC	1
Spare control coil	Ex9C300	220 V AC/DC	107993	ECC45 220V AC/DC	1
Spare control coil	Ex9C300	127 V AC/DC	107992	ECC45 127V AC/DC	1
Spare control coil	Ex9C300	110 V AC/DC	107991	ECC45 110V AC/DC	1
Spare control coil	Ex9C300	48 V AC/DC	107990	ECC45 48V AC/DC	1
Spare control coil	Ex9C300	42 V AC/DC	107989	ECC45 42V AC/DC	1
Spare control coil	Ex9C300	36 V AC/DC	107988	ECC45 36V AC/DC	1
Spare control coil	Ex9C300	24 V AC/DC	107987	ECC45 24V AC/DC	1
Spare control coil	Ex9C500	415 V AC/DC	108010	ECC46 415V AC/DC	1
Spare control coil	Ex9C500	400 V AC/DC	108009	ECC46 400V AC/DC	1
Spare control coil	Ex9C500	380 V AC/DC	108008	ECC46 380V AC/DC	1
Spare control coil	Ex9C500	240 V AC/DC	108007	ECC46 240V AC/DC	1
Spare control coil	Ex9C500	230 V AC/DC	108006	ECC46 230V AC/DC	1
Spare control coil	Ex9C500	220 V AC/DC	108005	ECC46 220V AC/DC	1
Spare control coil	Ex9C500	127 V AC/DC	108004	ECC46 127V AC/DC	1
Spare control coil	Ex9C500	110 V AC/DC	108003	ECC46 110V AC/DC	1
Spare control coil	Ex9C500	48 V AC/DC	108002	ECC46 48V AC/DC	1
Spare control coil	Ex9C500	42 V AC/DC	108001	ECC46 42V AC/DC	1
Spare control coil	Ex9C500	36 V AC/DC	108000	ECC46 36V AC/DC	1
Spare control coil	Ex9C500*	24 V AC/DC	107999	ECC46 24V AC/DC	1

\*) for 24V version of Ex9C500 contactors cannot be used control coil with different  $U_c$ .

# Notes

A large grid of dashed lines for taking notes, covering most of the page area below the header.

# Accessories for Ex9S32A



- Accessories for motor protective circuit breakers Ex9S32A
- Front-mounted auxiliary contacts AX51
- Side-mounted auxiliary contacts AX52
- Side-mounted alarm contact AL5111
- Shunt trip release SHT51
- Undervoltage release UVT51
- Terminal adapters CC5
- Adapter holder DRA51

Ex9S32A motor protective circuit breakers can be equipped with various types of additional accessories. All the accessories are designed in the way to be possible to combine different types with one device. There can be used up to three auxiliary or alarm contact units plus one voltage release.

Auxiliary contact units are available with three possible contact combinations. Auxiliary and alarm contact units to be mounted from the left to the device. Release units are mounted from the right side. Installation of an auxiliary or alarm contact units does not affect the possibility of installing voltage release.

## Type Key

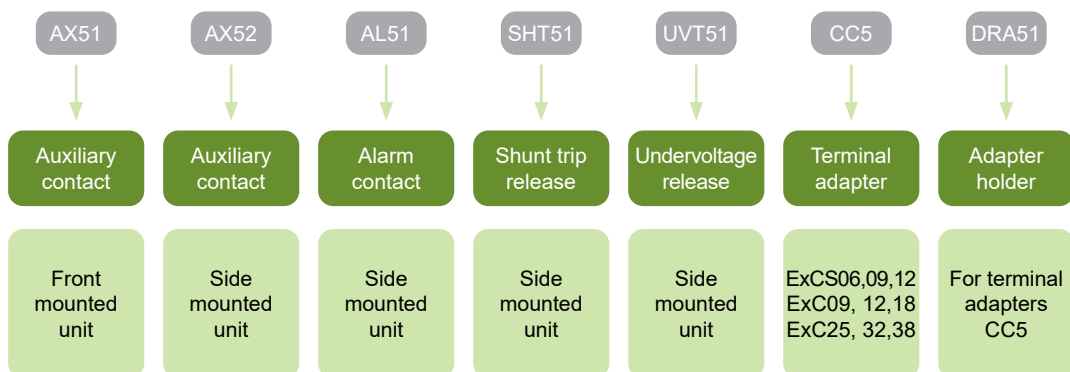

# Accessories for Ex9S32A

## Auxiliary contacts for Ex9S32A, front-mounted



Contacts	Suitable for	Article No.	Type	Packing
1 NO + 1 NC	Ex9S32A	108143	AX51 11	10/720
2 NO	Ex9S32A	108144	AX51 20	10/720

Technical data p. 227

## Auxiliary contacts for Ex9S32A, side-mounted



Contacts	Suitable for	Article No.	Type	Packing
1 NO + 1 NC	Ex9S32A	108145	AX52 11	2/192
2 NO	Ex9S32A	108146	AX52 20	2/192
2 NC	Ex9S32A	108147	AX52 02	2/192

Technical data p. 228

## Alarm contact for Ex9S32A, side-mounted



Contacts	Suitable for	Article No.	Type	Packing
1 NO + 1 NC	Ex9S32A	108154	AL5111	1/96

Technical data p. 229

## Shunt trip releases for Ex9S32A, side-mounted



AC oper. voltage	Suitable for	Article No.	Type	Packing
110 – 115 V AC	Ex9S32A	108151	SHT51F	1/96
220 – 240 V AC	Ex9S32A	108152	SHT51G	1/96
380 – 400 V AC	Ex9S32A	108153	SHT51H	1/96

Technical data p. 230



# Accessories for Ex9S32A

## Undervoltage releases for Ex9S32A, side-mounted



Technical data p. 231

AC oper. voltage	Suitable for	Article No.	Type	Packing
110 – 115 V AC	Ex9S32A	108148	UVT51I	1/96
220 – 240 V AC	Ex9S32A	108149	UVT51J	1/96
380 – 400 V AC	Ex9S32A	108150	UVT51K	1/96

## Terminal adapters for Ex9S32A



For contactors size	Suitable for	Article No.	Type	Packing
Ex9CS06, 09, 12	Ex9S32A	108155	CC51	6/240
Ex9C09, 12, 18	Ex9S32A	109077	CC52	3/120
Ex9C25, 32, 38	Ex9S32A	109078	CC53	3/60

## Adapter holder for Ex9S32A



For terminal adapters	Suitable for	Article No.	Type	Packing
CC51, CC52, CC53	Ex9S32A	109079	DRA51	16/96

# Notes

A large grid of dashed lines for taking notes, covering most of the page below the 'Notes' header.

# Accessories for Ex9SN25B



- Accessories for motor protective circuit breakers Ex9SN25B
- Front-mounted auxiliary contacts ASNB
- Side-mounted auxiliary contacts ASNA
- Side-mounted alarm contact ASNF
- Undervoltage release ASNUV
- Shunt trip release ASNT
- Isolated boxes for surface mounting

Ex9SN25B motor protective circuit breakers can be equipped with various types of additional accessories. All the accessories are designed in the way to be possible to combine different types with one device. There can be used up to three auxiliary or alarm contact units plus one voltage release.

Auxiliary contact units are available with three possible contact combinations. Auxiliary and alarm contact units are mounted from the left to the device. Release units are mounted from the right side. Installation of an auxiliary or alarm contact units does not affect the possibility of installing voltage release.

## Type Key

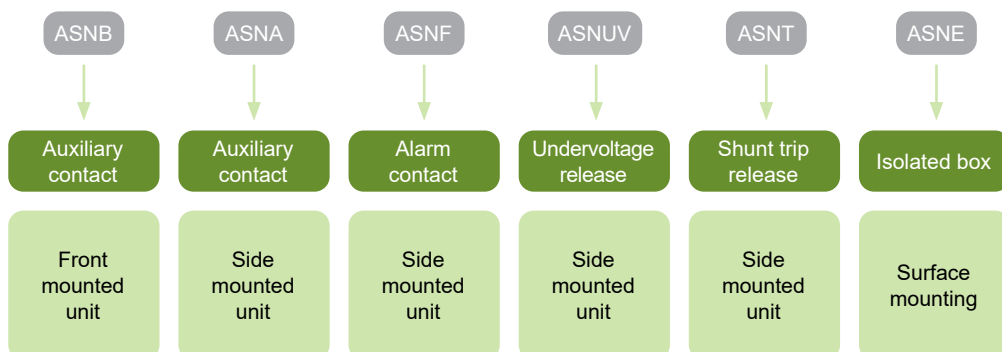

# Accessories for Ex9SN25B

## Auxiliary contacts for Ex9SN25B, front-mounted



Contacts	Suitable for	Article No.	Type	Packing
2 NO	Ex9SN25B	108956	ASNB20	20/1280
1 NO + 1 NC	Ex9SN25B	108957	ASNB11	20/1280

Technical data p. 232

## Auxiliary contacts for Ex9SN25B, side-mounted



Contacts	Suitable for	Article No.	Type	Packing
2 NO	Ex9SN25B	108954	ASNA20	4/256
1 NO + 1 NC	Ex9SN25B	108955	ASNA11	4/256

Technical data p. 233

## Alarm contacts for Ex9SN25B, side-mounted



Contacts	Suitable for	Article No.	Type	Packing
1 NO (Fault) + 1 NC (Aux)	Ex9SN25B	108964	ASNF1001	3/192
1 NC (Fault) + 1 NC (Aux)	Ex9SN25B	108965	ASNF0101	3/192
1 NO (Fault) + 1 NO (Aux)	Ex9SN25B	108966	ASNF1010	3/192
1 NC (Fault) + 1 NO (Aux)	Ex9SN25B	108967	ASNF0110	3/192

Technical data p. 234

# Accessories for Ex9SN25B

## Undervoltage releases for Ex9SN25B, side-mounted



AC operating voltage	Suitable for	Article No.	Type	Packing
110-115V 50Hz/127V 60Hz	Ex9SN25B	108958	ASNUVA	2/128
220-240V 50Hz	Ex9SN25B	108959	ASNUVB	2/128
380-400V 50Hz/ 440V 60Hz	Ex9SN25B	108960	ASNUVC	2/128

Technical data p. 236

## Shunt trip releases for Ex9SN25B, side-mounted



AC operating voltage	Suitable for	Article No.	Type	Packing
110-115V 50Hz/127V 60Hz	Ex9SN25B	108961	ASNTA	2/128
220-240V 50Hz	Ex9SN25B	108962	ASNTB	2/128
380-400V 50Hz/ 440V 60Hz	Ex9SN25B	108963	ASNTC	2/128

Technical data p. 235

## Isolated boxes for Ex9SN25B, surface mounting



Description	Suitable for	Article No.	Type	Packing
Actuating diaphragm	Ex9SN25B	108968	ASNEA	1/20
Emergency stop pushbutton	Ex9SN25B	108969	ASNEB	1/12

Technical data p. 237

# Notes

A large grid of dashed lines for taking notes, covering most of the page area below the header.

# Accessories for overload thermal relays



- Accessories for Overload thermal relays Ex9R
- Adaptors for stand-alone applications of the relays
- Enable mounting of the overload relay onto 35 mm device rail or panel
- Equipped with a set of terminals for wire connection of the relay at both sides

AD5. adaptors are designed in order to allow a use of overload thermal relays Ex9R separately without a contactor of Ex9C(S) series.

Adaptor AD51 fits to overload thermal relays Ex9R12. For relays Ex9R38, the adaptor AD56 is intended. Overload thermal relays type Ex9R100 can be combined with AD53, the size R185 with AD54 and the biggest type size R500 with AD55 adaptor.

## Type Key

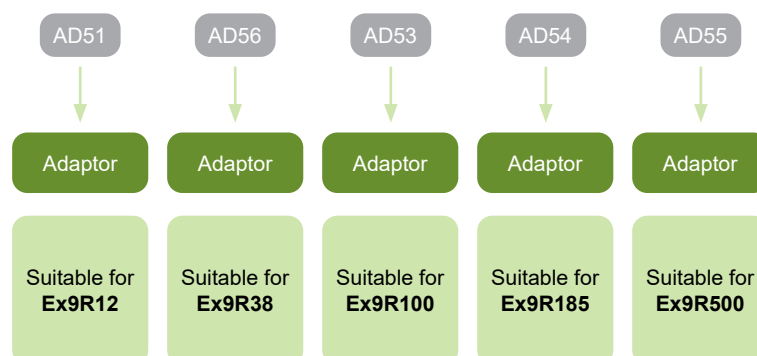

# Accessories for overload thermal relays

## Mounting



**Ex9R**  
Basic relay



**AD5.**  
Adaptor



**Ex9R + AD5.**  
For stand-alone  
applications



# Accessories for overload thermal relays

## Adaptors for stand-alone applications of Ex9R relays up to 100 A

- Enable use of overload relay separately without a contactor
- For direct mounting onto 35 mm device rail



Description	Suitable for	Article No.	Type	Packing
Adaptor	Ex9R12	101436	AD51	2/80
Adaptor	Ex9R38	110339	AD56	2/80
Adaptor	Ex9R100	101438	AD53	2/24

## Adaptors for stand-alone applications of Ex9R185/500 relays

- Enable use of overload relay separately without a contactor
- For direct mounting onto panel with screws



Description	Suitable for	Article No.	Type	Packing
Adaptor	Ex9R185	107968	AD54	1/12
Adaptor	Ex9R500	107969	AD55	1/12

# Notes

A large grid of dashed lines for taking notes, covering most of the page area below the header.

# Panel Mounted Devices



Panel Mounted  
Devices

# Panel mounted devices

## Professional Tips

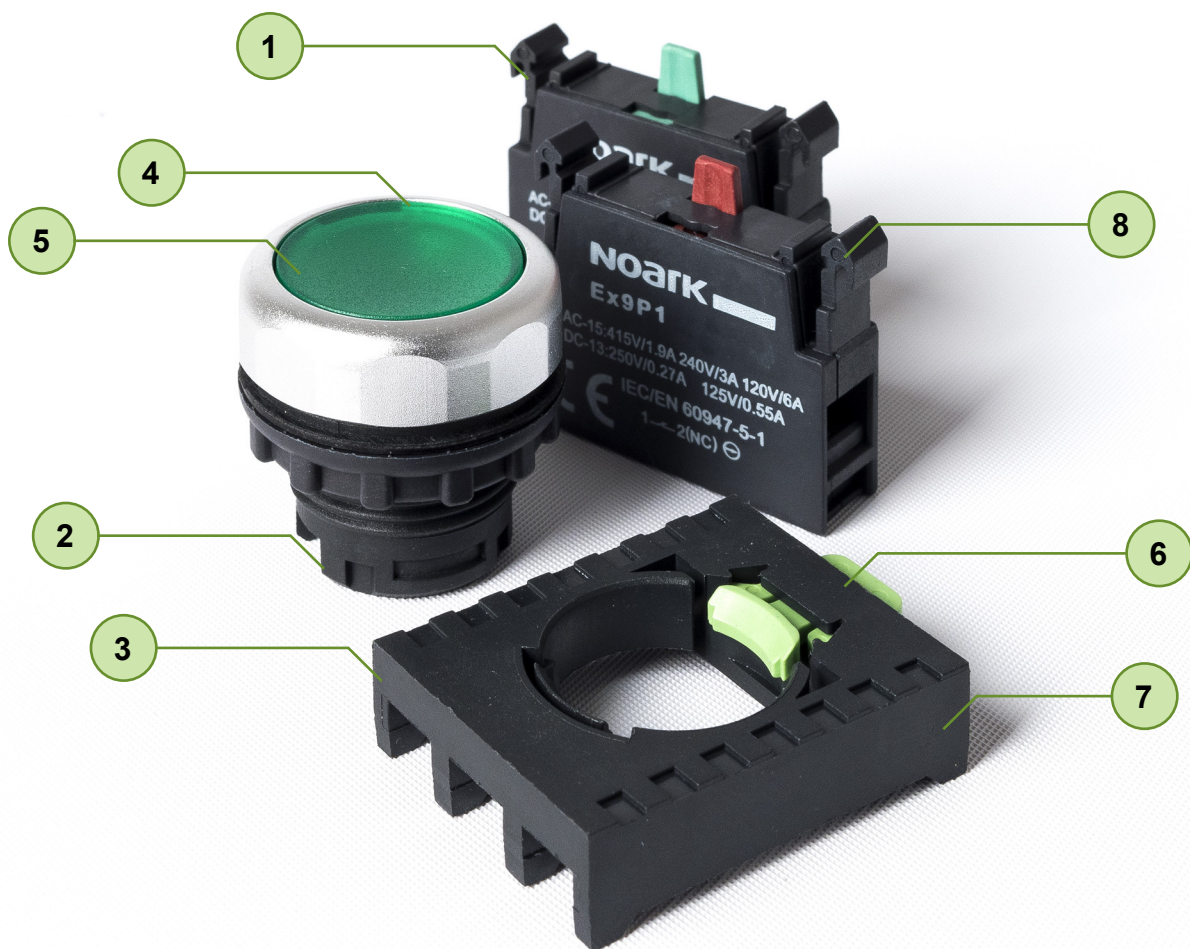

- 1 5 year warranty
- 2 Degree of protection IP65 for Ex9P1, IL
- 3 Control devices, signal lamps and buzzers
- 4 LED lamps with high brightness
- 5 Various colour of buttons and lamps
- 6 Easy mounting into standard 22 mm
- 7 Compact design
- 8 Different types of operating heads

# Panel mounted control devices Ex9P1 & Ex9P2



- Panel mounted control devices
- Tested according to IEC / EN 60947-5-1
- Various operating head types
- Easy mounting into standard 22 mm panel cutout
- Degree of protection IP65
- Convenient mounting and demounting
- LED lamp units with high brightness
- Configurable system, arbitrary combination of head, contact and LED units for various applications Design compact

Panel mounted control devices line Ex9P1 are used in various control desks, operator panels or machine control circuit parts as well as for control functions in power distribution boards. They are designed as compact devices combined from various modular parts - operating head, basement, contact and illumination units. These parts can be freely combined to realize different functions.

For semi-transparent (illuminated) version there can be used LED unit with high brightness which ensures reliable indication of connected circuit, reduces power consumption and extends service life.

The operating heads are designed in bright colours and streamline surface. They are available in many various colours, shapes and types.

## Type Key

Ex9	P1	M	6		I		g
Product family	Product	Operating part type	Head size	Holes	Illumination possibility	Key lockable	Colour
Ex9	P1, P2: Panel mounted control devices	F: flat button R: raised button D: dual colour button FH: push button box  M: mushroom button H: maintained mushroom for Emergency stop  S: 2-position selector S3: 3-position selector  P: signal lamp	_: 40 mm 6: 60 mm	1: one hole 2: two holes 3: three holes	_: no I: yes	_: no K: yes	_: metal g: green r: red w: white k: black y: yellow b: blue

## Certification marks



# Panel mounted control devices Ex9P1 & Ex9P2

## Head types overview



Flat buttons  
Ex9P1 F



Raised buttons  
Ex9P1 R



Dual colour buttons  
Ex9P1 D



Mushroom buttons  
Ex9P1 M



Emergency stop  
Ex9P1 H



Selector switches  
Ex9P1 S



Switches with key  
Ex9P1 SK



Signal lamps  
Ex9P1 P



Push button boxes  
Ex9P2 FH

## Mounting principle

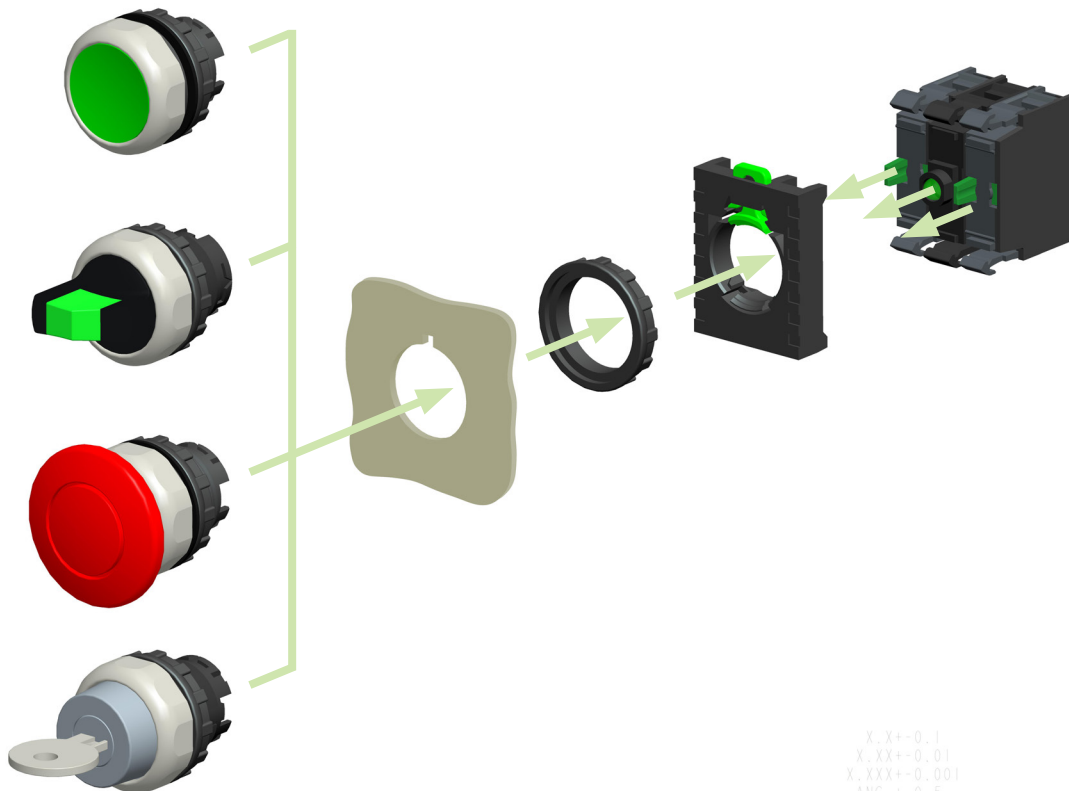

X, X+0.1  
X, XX+0.01  
X, XXX+0.001  
ANG, +0.5

# Panel mounted control devices Ex9P1 & Ex9P2

## Flat buttons

- Momentary function
- Without printing on the head
- Function elements and basement to be ordered separately
- Scope of delivery: flat button head with aluminium cover ring



Colour	Illumination possibility	Article No.	Type	Packing
white	no	105612	Ex9P1 F w	1/20/360
black	no	105613	Ex9P1 F k	1/20/360
green	no	105614	Ex9P1 F g	1/20/360
red	no	105615	Ex9P1 F r	1/20/360
yellow	no	105616	Ex9P1 F y	1/20/360
blue	no	105617	Ex9P1 F b	1/20/360
clear	yes	105618	Ex9P1 FI w	1/20/360
green	yes	105619	Ex9P1 FI g	1/20/360
red	yes	105620	Ex9P1 FI r	1/20/360
yellow	yes	105621	Ex9P1 FI y	1/20/360
blue	yes	105622	Ex9P1 FI b	1/20/360

## Raised buttons

- Momentary function
- Without printing on the head
- Function elements and basement to be ordered separately
- Scope of delivery: raised button head with aluminium cover ring



Colour	Illumination possibility	Article No.	Type	Packing
white	no	105623	Ex9P1 R w	1/10/320
black	no	105624	Ex9P1 R k	1/10/320
green	no	105625	Ex9P1 R g	1/10/320
red	no	105626	Ex9P1 R r	1/10/320
yellow	no	105627	Ex9P1 R y	1/10/320
blue	no	105628	Ex9P1 R b	1/10/320
clear	yes	105629	Ex9P1 RI w	1/10/320
green	yes	105630	Ex9P1 RI g	1/10/320
red	yes	105631	Ex9P1 RI r	1/10/320
yellow	yes	105632	Ex9P1 RI y	1/10/320
blue	yes	105633	Ex9P1 RI b	1/10/320

# Panel mounted control devices Ex9P1 & Ex9P2

## Mushroom type buttons, 40 mm

- Momentary function
- Without printing on the head
- Function elements and basement to be ordered separately
- Scope of delivery: mushroom button head with aluminium cover ring



Colour	Illumination possibility	Article No.	Type	Packing
white	no	105634	Ex9P1 M w	1/10/210
black	no	105635	Ex9P1 M k	1/10/210
green	no	105636	Ex9P1 M g	1/10/210
red	no	105637	Ex9P1 M r	1/10/210
yellow	no	105638	Ex9P1 M y	1/10/210
blue	no	105639	Ex9P1 M b	1/10/210
clear	yes	105640	Ex9P1 MI w	1/10/210
green	yes	105641	Ex9P1 MI g	1/10/210
red	yes	105642	Ex9P1 MI r	1/10/210
yellow	yes	105643	Ex9P1 MI y	1/10/210
blue	yes	105644	Ex9P1 MI b	1/10/210

## Mushroom type buttons, 60 mm

- Momentary function
- Without printing on the head
- Function elements and basement to be ordered separately
- Scope of delivery: mushroom button head with aluminium cover ring



Colour	Illumination possibility	Article No.	Type	Packing
white	no	105645	Ex9P1 M6 w	1/5/90
black	no	105646	Ex9P1 M6 k	1/5/90
green	no	105647	Ex9P1 M6 g	1/5/90
red	no	105648	Ex9P1 M6 r	1/5/90
yellow	no	105649	Ex9P1 M6 y	1/5/90
blue	no	105650	Ex9P1 M6 b	1/5/90
clear	yes	105651	Ex9P1 M6I w	1/5/90
green	yes	105652	Ex9P1 M6I g	1/5/90
red	yes	105653	Ex9P1 M6I r	1/5/90
yellow	yes	105654	Ex9P1 M6I y	1/5/90
blue	yes	105655	Ex9P1 M6I b	1/5/90



# Panel mounted control devices Ex9P1 & Ex9P2

## Mushroom type buttons for Emergency stop

- Maintained function for emergency stop use (release by rotation)
- Function elements and basement to be ordered separately
- Scope of delivery: emergency stop mushroom head



Colour	Diameter	Illumination	Article No.	Type	Packing
red	40 mm	no	105656	Ex9P1 H r	1/10/210
red	60 mm	no	105657	Ex9P1 H6 r	1/5/90

## Emergency stop stickers

- Yellow colour, circular shape
- With opening for 22 mm panel mouted devices
- Various diameter and language variants (empty, with emergency stop symbol only, em. stop symbol with text in given language)
- Self-adhesive flexible plastic material printed from back side
- The language version defines language of the text „Emergency stop“

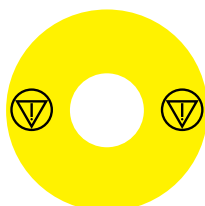

107871

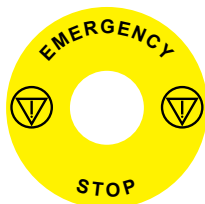

106807



106808

Diameter	Printing (language)	Article No.	Type	Packing
60 mm	empty	107868	Ex9P1 H S6EMPTY	1/10
60 mm	emergency stop symbol	107869	Ex9P1 H S6EMS	1/10
60 mm	EN	106791	Ex9P1 H S6EN	1/10
60 mm	CZ	106792	Ex9P1 H S6CZ	1/10
60 mm	SK	106793	Ex9P1 H S6SK	1/10
60 mm	PL	106794	Ex9P1 H S6PL	1/10
60 mm	RO	106795	Ex9P1 H S6RO	1/10
60 mm	DE	106796	Ex9P1 H S6DE	1/10
60 mm	FR	106797	Ex9P1 H S6FR	1/10
60 mm	ES	106798	Ex9P1 H S6ES	1/10
60 mm	IT	106799	Ex9P1 H S6IT	1/10
60 mm	RU	106800	Ex9P1 H S6RU	1/10
60 mm	BG	106801	Ex9P1 H S6BG	1/10
60 mm	RS	106802	Ex9P1 H S6RS	1/10
60 mm	HU	106803	Ex9P1 H S6HU	1/10
60 mm	LT	106804	Ex9P1 H S6LT	1/10
60 mm	LV	106805	Ex9P1 H S6LV	1/10
60 mm	EE	106806	Ex9P1 H S6EE	1/10
90 mm	empty	107870	Ex9P1 H S9EMPTY	1/10
90 mm	emergency stop symbol	107871	Ex9P1 H S9EMS	1/10
90 mm	EN	106807	Ex9P1 H S9EN	1/10
90 mm	CZ	106808	Ex9P1 H S9CZ	1/10
90 mm	SK	106809	Ex9P1 H S9SK	1/10
90 mm	PL	106810	Ex9P1 H S9PL	1/10
90 mm	RO	106811	Ex9P1 H S9RO	1/10
90 mm	DE	106812	Ex9P1 H S9DE	1/10
90 mm	FR	106813	Ex9P1 H S9FR	1/10
90 mm	ES	106814	Ex9P1 H S9ES	1/10
90 mm	IT	106815	Ex9P1 H S9IT	1/10
90 mm	RU	106816	Ex9P1 H S9RU	1/10
90 mm	BG	106817	Ex9P1 H S9BG	1/10
90 mm	RS	106818	Ex9P1 H S9RS	1/10
90 mm	HU	106819	Ex9P1 H S9HU	1/10
90 mm	LT	106820	Ex9P1 H S9LT	1/10
90 mm	LV	106821	Ex9P1 H S9LV	1/10
90 mm	EE	106822	Ex9P1 H S9EE	1/10

# Panel mounted control devices Ex9P1 & Ex9P2

## 2-position selector switches

- Rotary switch with handle
- 60° angle between positions
- Without printing on the head
- Function elements and basement to be ordered separately
- Scope of delivery: switch head with aluminium cover ring

### Maintained function types



Positions	Colour	Illumination possibility	Article No.	Type	Packing
2	white	no	105665	Ex9P1 S w	1/10/320
2	black	no	105666	Ex9P1 S k	1/10/320
2	green	no	105667	Ex9P1 S g	1/10/320
2	red	no	105668	Ex9P1 S r	1/10/320
2	yellow	no	105669	Ex9P1 S y	1/10/320
2	blue	no	105670	Ex9P1 S b	1/10/320
2	clear	yes	105671	Ex9P1 SI w	1/10/320
2	green	yes	105672	Ex9P1 SI g	1/10/320
2	red	yes	105673	Ex9P1 SI r	1/10/320
2	yellow	yes	105674	Ex9P1 SI y	1/10/320
2	blue	yes	105675	Ex9P1 SI b	1/10/320

### Momentary function types



Positions	Colour	Illumination possibility	Article No.	Type	Packing
2	white	no	105511	Ex9P1 SS w	1/10/320
2	black	no	105512	Ex9P1 SS k	1/10/320
2	green	no	105513	Ex9P1 SS g	1/10/320
2	red	no	105514	Ex9P1 SS r	1/10/320
2	yellow	no	105515	Ex9P1 SS y	1/10/320
2	blue	no	105516	Ex9P1 SS b	1/10/320
2	clear	yes	105517	Ex9P1 SSI w	1/10/320
2	green	yes	105518	Ex9P1 SSI g	1/10/320
2	red	yes	105519	Ex9P1 SSI r	1/10/320
2	yellow	yes	105520	Ex9P1 SSI y	1/10/320
2	blue	yes	105521	Ex9P1 SSI b	1/10/320

# Panel mounted control devices Ex9P1 & Ex9P2

## 3-position selector switches

- Rotary switch with handle
- 60° angle between positions
- Without printing on the head
- Function elements and basement to be ordered separately
- Scope of delivery: switch head with aluminium cover ring

### Maintained function types



Positions	Colour	Illumination possibility	Article No.	Type	Packing
3	white	no	105677	Ex9P1 S3 w	1/10/320
3	black	no	105678	Ex9P1 S3 k	1/10/320
3	green	no	105679	Ex9P1 S3 g	1/10/320
3	red	no	105680	Ex9P1 S3 r	1/10/320
3	yellow	no	105681	Ex9P1 S3 y	1/10/320
3	blue	no	105682	Ex9P1 S3 b	1/10/320
3	clear	yes	105683	Ex9P1 S3l w	1/10/320
3	green	yes	105684	Ex9P1 S3l g	1/10/320
3	red	yes	105685	Ex9P1 S3l r	1/10/320
3	yellow	yes	105686	Ex9P1 S3l y	1/10/320
3	blue	yes	105687	Ex9P1 S3l b	1/10/320

### Momentary function types



Positions	Colour	Illumination possibility	Article No.	Type	Packing
3	white	no	105522	Ex9P1 SS3 w	1/10/320
3	black	no	105523	Ex9P1 SS3 k	1/10/320
3	green	no	105524	Ex9P1 SS3 g	1/10/320
3	red	no	105525	Ex9P1 SS3 r	1/10/320
3	yellow	no	105526	Ex9P1 SS3 y	1/10/320
3	blue	no	105527	Ex9P1 SS3 b	1/10/320
3	clear	yes	105528	Ex9P1 SS3l w	1/10/320
3	green	yes	105529	Ex9P1 SS3l g	1/10/320
3	red	yes	105530	Ex9P1 SS3l r	1/10/320
3	yellow	yes	105531	Ex9P1 SS3l y	1/10/320
3	blue	yes	105532	Ex9P1 SS3l b	1/10/320

# Panel mounted control devices Ex9P1 & Ex9P2

## 3-position selector switches

- Rotary switch with handle
- 60° angle between positions
- Without printing on the head
- Function elements and basement to be ordered separately
- Scope of delivery: switch head with aluminium cover ring

### Maintained-momentary function types



Positions	Colour	Illumination possibility	Article No.	Type	Packing
3	white	no	105544	Ex9P1 SMS3 w	1/10/320
3	black	no	105545	Ex9P1 SMS3 k	1/10/320
3	green	no	105546	Ex9P1 SMS3 g	1/10/320
3	red	no	105547	Ex9P1 SMS3 r	1/10/320
3	yellow	no	105548	Ex9P1 SMS3 y	1/10/320
3	blue	no	105549	Ex9P1 SMS3 b	1/10/320
3	clear	yes	105550	Ex9P1 SMS3l w	1/10/320
3	green	yes	105551	Ex9P1 SMS3l g	1/10/320
3	red	yes	105552	Ex9P1 SMS3l r	1/10/320
3	yellow	yes	105553	Ex9P1 SMS3l y	1/10/320
3	blue	yes	105554	Ex9P1 SMS3l b	1/10/320

### Momentary-maintained function types



Positions	Colour	Illumination possibility	Article No.	Type	Packing
3	white	no	105533	Ex9P1 SSM3 w	1/10/320
3	black	no	105534	Ex9P1 SSM3 k	1/10/320
3	green	no	105535	Ex9P1 SSM3 g	1/10/320
3	red	no	105536	Ex9P1 SSM3 r	1/10/320
3	yellow	no	105537	Ex9P1 SSM3 y	1/10/320
3	blue	no	105538	Ex9P1 SSM3 b	1/10/320
3	clear	yes	105539	Ex9P1 SSM3l w	1/10/320
3	green	yes	105540	Ex9P1 SSM3l g	1/10/320
3	red	yes	105541	Ex9P1 SSM3l r	1/10/320
3	yellow	yes	105542	Ex9P1 SSM3l y	1/10/320
3	blue	yes	105543	Ex9P1 SSM3l b	1/10/320

# Panel mounted control devices Ex9P1 & Ex9P2

## 2-position selector switches with key

- Rotary switch with key
- 60° angle between positions
- The key can be removed in any maintained position
- Identical key for all ordered pieces
- Without printing on the head
- Function elements and basement to be ordered separately
- Scope of delivery: switch head with aluminium cover ring, 2 keys

### Maintained function types



Positions	Article No.	Type	Packing
2	105676	Ex9P1 SK	1/10/320

### Momentary function types



Positions	Article No.	Type	Packing
2	105555	Ex9P1 SSK	1/10/320

# Panel mounted control devices Ex9P1 & Ex9P2

## 3-position selector switches with key

- Rotary switch with key
- 60° angle between positions
- The key can be removed in any maintained position
- Identical key for all ordered pieces
- Without printing on the head
- Function elements and basement to be ordered separately
- Scope of delivery: switch head with aluminium cover ring, 2 keys

### Maintained function types



Positions	Article No.	Type	Packing
3	105688	Ex9P1 S3K	1/10/320

### Momentary function types



Positions	Article No.	Type	Packing
3	105556	Ex9P1 SS3K	1/10/320

### Maintained-momentary function types



Positions	Maintained position	Article No.	Type	Packing
3	right	105557	Ex9P1 SSM3K	1/10/320
3	left	105558	Ex9P1 SMS3K	1/10/320

# Panel mounted control devices Ex9P1 & Ex9P2

## Dual colour buttons

- Momentary function
- Center (white) part illuminated and semi-transparent in Ex9P1 DI version
- Without printing on the head
- Function elements and basement to be ordered separately
- Scope of delivery: dual colour button head



Colour	Illumination possibility	Article No.	Type	Packing
green+red	no	105658	Ex9P1 D gr	1/10/120
green+red	yes	105659	Ex9P1 DI gr	1/10/120

## Signal lamps

- Various colour diffusion light lens
- Without printing on the head
- Function elements and basement to be ordered separately
- Scope of delivery: signal lamp head with aluminium cover ring



Colour	Article No.	Type	Packing
white	105660	Ex9P1 PI w	1/20/360
green	105661	Ex9P1 PI g	1/20/360
red	105662	Ex9P1 PI r	1/20/360
yellow	105663	Ex9P1 PI y	1/20/360
blue	105664	Ex9P1 PI b	1/20/360

## Basement

- Compatible with all control head types, contact and LED units
- Flush mounting
- Up to 3 contact units (or 2 contact + 1 LED units)
- Allows to combine device heads with function elements



Description	Article No.	Type	Packing
Basement for 3 units	105611	Ex9P1 B3	1/60/1080

## Part for middle contact unit control

- Inserted into the head for control of the middle contact unit (instead of LED unit)
- Suitable for Ex9P1 F\*, R\*, M\* control head types with illumination possibility



Description	Article No.	Type	Packing
Part for middle contact control	105580	Ex9P1 MC	1/60/1080

# Panel mounted control devices Ex9P1 & Ex9P2

## Contact units

- Single contact units
- Normally open (NO) or normally close (NC) internal contact version
- Control moving part colour according to internal contact type
- Maximum two contact units in a stack
- For flush mounting type basement
- Arbitrary position in the basement, central position block must to be used with Ex9P1 MC part (see technical parameters)



Contact	Colour	Article No.	Type	Packing
1 NO	green	105578	Ex9P1 1NO	1/90/1620
1 NC	red	105579	Ex9P1 1NC	1/90/1620

## LED units

- Various colour and rated voltage versions
- To be installed to the middle position in the basement
- Suitable for all illuminated control head types
- For flush mounting type basement



Colour	Rated voltage	Article No.	Type	Packing
white	6 V AC/DC	105581	Ex9P1 LEDw 6V AC/DC	1/60/1080
white	12 V AC/DC	105582	Ex9P1 LEDw 12V AC/DC	1/60/1080
white	24 V AC/DC	105583	Ex9P1 LEDw 24V AC/DC	1/60/1080
white	36 V AC/DC	105584	Ex9P1 LEDw 36V AC/DC	1/60/1080
white	110-230 V AC	105585	Ex9P1 LEDw 110V-230V AC	1/60/1080
red	6 V AC/DC	105587	Ex9P1 LEDr 6V AC/DC	1/60/1080
red	12 V AC/DC	105588	Ex9P1 LEDr 12V AC/DC	1/60/1080
red	24 V AC/DC	105589	Ex9P1 LEDr 24V AC/DC	1/60/1080
red	36 V AC/DC	105590	Ex9P1 LEDr 36V AC/DC	1/60/1080
red	110-230 V AC	105591	Ex9P1 LEDr 110V-230V AC	1/60/1080
green	6 V AC/DC	105593	Ex9P1 LEDg 6V AC/DC	1/60/1080
green	12 V AC/DC	105594	Ex9P1 LEDg 12V AC/DC	1/60/1080
green	24 V AC/DC	105595	Ex9P1 LEDg 24V AC/DC	1/60/1080
green	36 V AC/DC	105596	Ex9P1 LEDg 36V AC/DC	1/60/1080
green	110-230 V AC	105597	Ex9P1 LEDg 110V-230V AC	1/60/1080
yellow	6 V AC/DC	105599	Ex9P1 LEDy 6V AC/DC	1/60/1080
yellow	12 V AC/DC	105600	Ex9P1 LEDy 12V AC/DC	1/60/1080
yellow	24 V AC/DC	105601	Ex9P1 LEDy 24V AC/DC	1/60/1080
yellow	36 V AC/DC	105602	Ex9P1 LEDy 36V AC/DC	1/60/1080
yellow	110-230 V AC	105603	Ex9P1 LEDy 110V-230V AC	1/60/1080
blue	6 V AC/DC	105605	Ex9P1 LEDb 6V AC/DC	1/60/1080
blue	12 V AC/DC	105606	Ex9P1 LEDb 12V AC/DC	1/60/1080
blue	24 V AC/DC	105607	Ex9P1 LEDb 24V AC/DC	1/60/1080
blue	36 V AC/DC	105608	Ex9P1 LEDb 36V AC/DC	1/60/1080
blue	110-230 V AC	105609	Ex9P1 LEDb 110V-230V AC	1/60/1080



# Panel mounted control devices Ex9P1 & Ex9P2

## Position and function description labels

- Various versions of labels
- Holder and labels to be ordered separately
- Silver plastic material of stickers
- Self-adhesive - can be stuck onto the holder or inserted underneath of transparent cover
- Printing colour of standard and customer defined labels: black
- Customer defined variants of labels (ordering quantity as multiple of 7 pcs, printing can be different for every single piece)\*



Description	Article No.	Type	Packing
Holder for labels	106776	Ex9P1 S SH	1
<b>Label printing</b>			
Description	Article No.	Type	Packing
Empty label (25x11 mm)	106777	Ex9P1 S S0	10
OFF - ON	106778	Ex9P1 S S1	10
0 - I	106779	Ex9P1 S S2	10
I - 0 - II	106780	Ex9P1 S S3	10
STOP - START	106781	Ex9P1 S S4	10
0 - 1	106782	Ex9P1 S S5	10
1 - 0 - 2	106783	Ex9P1 S S6	10
STOP	106784	Ex9P1 S S7	10
START	106785	Ex9P1 S S8	10
ON	106786	Ex9P1 S S9	10
OFF	106787	Ex9P1 S S10	10
RUN	106788	Ex9P1 S S11	10
AUTO	106789	Ex9P1 S S12	10
FAULT	106790	Ex9P1 S S13	10
Customer defined printing*	107876	Ex9P1 S S_USER	7

*\*) Ordering of customer defined stickers:*

- Order the item 107876
- Attach the information with requested sticker text and quantity of stickers with given content. Each sticker can be different
- Minimum ordering quantity is 7 pieces and multiples
- In case of graphic symbol to be produced, it is necessary to deliver source data (pdf, ai, jpg, png, etc.)
- Mention positioning of the sticker (standard horizontal, vertical)
- Maximum printable area is 10 x 24 mm (H x W)

# Panel mounted control devices Ex9P1 & Ex9P2

## Push button box 1 hole

- Push button box for panel mounted devices Ex9P1 - one hole
- Grey or yellow colour
- Degree of protection IP65
- Scope of delivery: push button box plus 2 grommets



Colour	Article No.	Type	Packing
grey	111409	Ex9P2 FH 1	1/40
yellow	111412	Ex9P2 FH 1 y	1/40

## Push button box 2 holes

- Push button box for panel mounted devices Ex9P1 - two holes
- Grey or yellow colour
- Degree of protection IP65
- Scope of delivery: push button box plus 2 grommets



Colour	Article No.	Type	Packing
grey	111410	Ex9P2 FH 2	1/32
yellow	111413	Ex9P2 FH 2 y	1/32

## Push button box 3 holes

- Push button box for panel mounted devices Ex9P1 - three holes
- Grey or yellow colour
- Degree of protection IP65
- Scope of delivery: push button box plus 2 grommets



Colour	Article No.	Type	Packing
grey	111411	Ex9P2 FH 3	1/36
yellow	111414	Ex9P2 FH 3 y	1/36

# Panel mounted signal lamps Ex9IL



- Panel mounted signal lamps
- Tested according to IEC / EN 60947-5-1
- Degree of protection IP65
- Flat and arc shaped head cover types
- Various colour cover variants
- Height 51 or 53 mm
- Easy mounting into standard 22 mm panel cutout
- LED technology
- Compact design

Panel mounted signal lamps Ex9IL are used in various control desks, operator panels, machine control parts, security systems as well as in power distribution boards where it is necessary to show actual status or some event occurring in the circuit. Device's height is 51 or 53 mm (depends on type) only. There are available versions with white, green, red, yellow or blue head colour in two basic design variants. The first one with flat and the second with arc shaped head cover.

Based on the requested application, there are offered two variants according to internal connection, resistance and capacitance types. Used LED lights reduce current consumption, heat dissipation and extend service life.

## Type Key

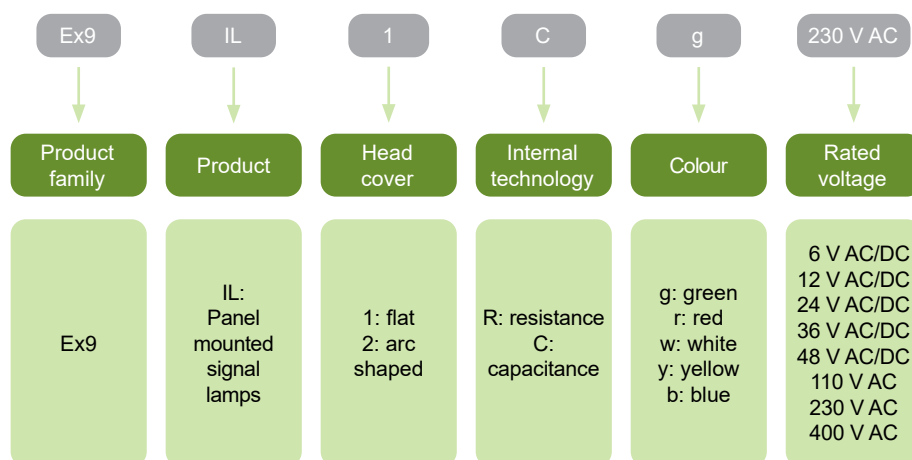

## Certification marks



# Panel mounted signal lamps Ex9IL

## Flat shaped head cover types

- Scope of delivery: complete device consisting of device body, internal LED function block, head cover



Rated voltage	Colour	Technology	Article No.	Type	Packing
6 V AC/DC	white	resistance	105413	Ex9IL 1R w 6V AC/DC	1/10
6 V AC/DC	green	resistance	105414	Ex9IL 1R g 6V AC/DC	1/10
6 V AC/DC	red	resistance	105415	Ex9IL 1R r 6V AC/DC	1/10
6 V AC/DC	yellow	resistance	105416	Ex9IL 1R y 6V AC/DC	1/10
6 V AC/DC	blue	resistance	105417	Ex9IL 1R b 6V AC/DC	1/10
12 V AC/DC	white	resistance	105418	Ex9IL 1R w 12V AC/DC	1/10
12 V AC/DC	green	resistance	105419	Ex9IL 1R g 12V AC/DC	1/10
12 V AC/DC	red	resistance	105420	Ex9IL 1R r 12V AC/DC	1/10
12 V AC/DC	yellow	resistance	105421	Ex9IL 1R y 12V AC/DC	1/10
12 V AC/DC	blue	resistance	105422	Ex9IL 1R b 12V AC/DC	1/10
24 V AC/DC	white	resistance	105423	Ex9IL 1R w 24V AC/DC	1/10
24 V AC/DC	green	resistance	105424	Ex9IL 1R g 24V AC/DC	1/10
24 V AC/DC	red	resistance	105425	Ex9IL 1R r 24V AC/DC	1/10
24 V AC/DC	yellow	resistance	105426	Ex9IL 1R y 24V AC/DC	1/10
24 V AC/DC	blue	resistance	105427	Ex9IL 1R b 24V AC/DC	1/10
36 V AC/DC	white	resistance	105428	Ex9IL 1R w 36V AC/DC	1/10
36 V AC/DC	green	resistance	105429	Ex9IL 1R g 36V AC/DC	1/10
36 V AC/DC	red	resistance	105430	Ex9IL 1R r 36V AC/DC	1/10
36 V AC/DC	yellow	resistance	105431	Ex9IL 1R y 36V AC/DC	1/10
36 V AC/DC	blue	resistance	105432	Ex9IL 1R b 36V AC/DC	1/10
48 V AC/DC	white	resistance	105433	Ex9IL 1R w 48V AC/DC	1/10
48 V AC/DC	green	resistance	105434	Ex9IL 1R g 48V AC/DC	1/10
48 V AC/DC	red	resistance	105435	Ex9IL 1R r 48V AC/DC	1/10
48 V AC/DC	yellow	resistance	105436	Ex9IL 1R y 48V AC/DC	1/10
48 V AC/DC	blue	resistance	105437	Ex9IL 1R b 48V AC/DC	1/10
110 V AC	white	capacitance	105438	Ex9IL 1C w 110V AC	1/10
110 V AC	green	capacitance	105439	Ex9IL 1C g 110V AC	1/10
110 V AC	red	capacitance	105440	Ex9IL 1C r 110V AC	1/10
110 V AC	yellow	capacitance	105441	Ex9IL 1C y 110V AC	1/10
110 V AC	blue	capacitance	105442	Ex9IL 1C b 110V AC	1/10
230 V AC	white	capacitance	105443	Ex9IL 1C w 230V AC	1/10
230 V AC	green	capacitance	105444	Ex9IL 1C g 230V AC	1/10
230 V AC	red	capacitance	105445	Ex9IL 1C r 230V AC	1/10
230 V AC	yellow	capacitance	105446	Ex9IL 1C y 230V AC	1/10
230 V AC	blue	capacitance	105447	Ex9IL 1C b 230V AC	1/10
400 V AC	white	capacitance	105448	Ex9IL 1C w 400V AC	1/10
400 V AC	green	capacitance	105449	Ex9IL 1C g 400V AC	1/10
400 V AC	red	capacitance	105450	Ex9IL 1C r 400V AC	1/10
400 V AC	yellow	capacitance	105451	Ex9IL 1C y 400V AC	1/10
400 V AC	blue	capacitance	105452	Ex9IL 1C b 400V AC	1/10

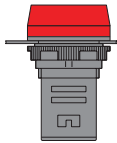

# Panel mounted signal lamps Ex9IL

## Arc shaped head cover types

- Scope of delivery: complete device consisting of device body, internal LED function block, head cover



Rated voltage	Colour	Technology	Article No.	Type	Packing
6 V AC/DC	white	resistance	105453	Ex9IL 2R w 6V AC/DC	1/10
6 V AC/DC	green	resistance	105454	Ex9IL 2R g 6V AC/DC	1/10
6 V AC/DC	red	resistance	105455	Ex9IL 2R r 6V AC/DC	1/10
6 V AC/DC	yellow	resistance	105456	Ex9IL 2R y 6V AC/DC	1/10
6 V AC/DC	blue	resistance	105457	Ex9IL 2R b 6V AC/DC	1/10
12 V AC/DC	white	resistance	105458	Ex9IL 2R w 12V AC/DC	1/10
12 V AC/DC	green	resistance	105459	Ex9IL 2R g 12V AC/DC	1/10
12 V AC/DC	red	resistance	105460	Ex9IL 2R r 12V AC/DC	1/10
12 V AC/DC	yellow	resistance	105461	Ex9IL 2R y 12V AC/DC	1/10
12 V AC/DC	blue	resistance	105462	Ex9IL 2R b 12V AC/DC	1/10
24 V AC/DC	white	resistance	105463	Ex9IL 2R w 24V AC/DC	1/10
24 V AC/DC	green	resistance	105464	Ex9IL 2R g 24V AC/DC	1/10
24 V AC/DC	red	resistance	105465	Ex9IL 2R r 24V AC/DC	1/10
24 V AC/DC	yellow	resistance	105466	Ex9IL 2R y 24V AC/DC	1/10
24 V AC/DC	blue	resistance	105467	Ex9IL 2R b 24V AC/DC	1/10
36 V AC/DC	white	resistance	105468	Ex9IL 2R w 36V AC/DC	1/10
36 V AC/DC	green	resistance	105469	Ex9IL 2R g 36V AC/DC	1/10
36 V AC/DC	red	resistance	105470	Ex9IL 2R r 36V AC/DC	1/10
36 V AC/DC	yellow	resistance	105471	Ex9IL 2R y 36V AC/DC	1/10
36 V AC/DC	blue	resistance	105472	Ex9IL 2R b 36V AC/DC	1/10
48 V AC/DC	white	resistance	105473	Ex9IL 2R w 48V AC/DC	1/10
48 V AC/DC	green	resistance	105474	Ex9IL 2R g 48V AC/DC	1/10
48 V AC/DC	red	resistance	105475	Ex9IL 2R r 48V AC/DC	1/10
48 V AC/DC	yellow	resistance	105476	Ex9IL 2R y 48V AC/DC	1/10
48 V AC/DC	blue	resistance	105477	Ex9IL 2R b 48V AC/DC	1/10
110 V AC	white	capacitance	105478	Ex9IL 2C w 110V AC	1/10
110 V AC	green	capacitance	105479	Ex9IL 2C g 110V AC	1/10
110 V AC	red	capacitance	105480	Ex9IL 2C r 110V AC	1/10
110 V AC	yellow	capacitance	105481	Ex9IL 2C y 110V AC	1/10
110 V AC	blue	capacitance	105482	Ex9IL 2C b 110V AC	1/10
230 V AC	white	capacitance	105483	Ex9IL 2C w 230V AC	1/10
230 V AC	green	capacitance	105484	Ex9IL 2C g 230V AC	1/10
230 V AC	red	capacitance	105485	Ex9IL 2C r 230V AC	1/10
230 V AC	yellow	capacitance	105486	Ex9IL 2C y 230V AC	1/10
230 V AC	blue	capacitance	105487	Ex9IL 2C b 230V AC	1/10
400 V AC	white	capacitance	105488	Ex9IL 2C w 400V AC	1/10
400 V AC	green	capacitance	105489	Ex9IL 2C g 400V AC	1/10
400 V AC	red	capacitance	105490	Ex9IL 2C r 400V AC	1/10
400 V AC	yellow	capacitance	105491	Ex9IL 2C y 400V AC	1/10
400 V AC	blue	capacitance	105492	Ex9IL 2C b 400V AC	1/10

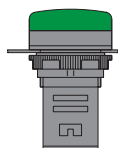

# Panel mounted signal lamps Ex9IL

## Spare flat shaped head covers



Colour	Article No.	Type	Packing
white	105403	Ex9IL 1 w	1/20
green	105404	Ex9IL 1 g	1/20
red	105405	Ex9IL 1 r	1/20
yellow	105406	Ex9IL 1 y	1/20
blue	105407	Ex9IL 1 b	1/20

## Spare arc shaped head covers



Colour	Article No.	Type	Packing
white	105408	Ex9IL 2 w	1/20
green	105409	Ex9IL 2 g	1/20
red	105410	Ex9IL 2 r	1/20
yellow	105411	Ex9IL 2 y	1/20
blue	105412	Ex9IL 2 b	1/20

## Position and function description labels

- Various versions of labels
- Holder and labels to be ordered separately
- Silver plastic material of stickers
- Self-adhesive - can be stuck onto the holder or inserted underneath of transparent cover
- Printing colour of standard and customer defined labels: black
- Customer defined variants of labels (ordering quantity as multiple of 7 pcs, printing can be different for every single piece)\*



Description	Article No.	Type	Packing
Holder for labels	106776	Ex9P1 S SH	1

Label printing	Article No.	Type	Packing
Empty label (25x11 mm)	106777	Ex9P1 S S0	10
OFF - ON	106778	Ex9P1 S S1	10
0 - I	106779	Ex9P1 S S2	10
I - 0 - II	106780	Ex9P1 S S3	10
STOP - START	106781	Ex9P1 S S4	10
0 - 1	106782	Ex9P1 S S5	10
1 - 0 - 2	106783	Ex9P1 S S6	10
STOP	106784	Ex9P1 S S7	10
START	106785	Ex9P1 S S8	10
ON	106786	Ex9P1 S S9	10
OFF	106787	Ex9P1 S S10	10
RUN	106788	Ex9P1 S S11	10
AUTO	106789	Ex9P1 S S12	10
FAULT	106790	Ex9P1 S S13	10
Customer defined printing*	107876	Ex9P1 S S_USER	7

*\*) Ordering of customer defined stickers:*

- Order the item 107876
- Attach the information with requested sticker text and quantity of stickers with given content. Each sticker can be different
- Minimum ordering quantity is 7 pieces and multiples
- In case of graphic symbol to be produced, it is necessary to deliver source data (pdf, ai, jpg, png, etc.)
- Mention positioning of the sticker (standard horizontal, vertical)
- Maximum printable area is 10 x 24 mm (H x W)

# Panel mounted buzzers Ex9PB



- Panel mounted buzzers
- Meet requirements of IEC / EN 60947-5-1
- Degree of protection IP30
- Interrupted and continuous variants
- Device's height 54 mm
- Easy mounting into 22 mm panel cutout
- Illuminated and non-illuminated versions
- LED lighting technology

Panel mounted buzzers Ex9PB are suitable mainly for industrial applications, security system, etc., where it is necessary to signalize with sound some event occurring in the circuit.

They are offered with device's body height 54 mm and two basic versions, interrupted and continuous. Both of them are available in illuminated and non-illuminated variants with black and semi-transparent red head colour, respectively. Used LEDs reduce current consumption, heat dissipation and extend service life.

## Type Key

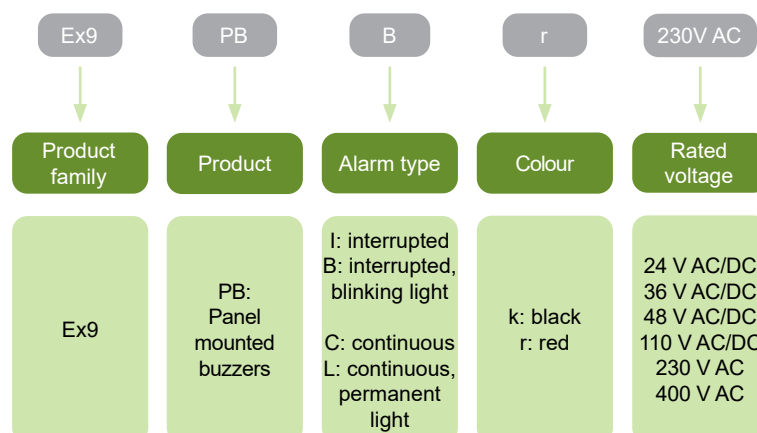

## Certification marks



# Panel mounted buzzers Ex9PB

## Interrupted types

- Tone length 0.5 s, signal frequency 1 Hz, tone frequency 2300 Hz, noise level 75-105 dB
- Scope of delivery: complete device consisting of device body, internal sound module, head cover



Rated voltage	Illuminated	Colour	Article No.	Type	Packing
24 V AC/DC	no	black	105689	Ex9PB I k 24V AC/DC	1/10
36 V AC/DC	no	black	105690	Ex9PB I k 36V AC/DC	1/10
48 V AC/DC	no	black	105691	Ex9PB I k 48V AC/DC	1/10
110 V AC/DC	no	black	105692	Ex9PB I k 110V AC/DC	1/10
230 V AC	no	black	105693	Ex9PB I k 230V AC	1/10
400 V AC	no	black	105694	Ex9PB I k 400V AC	1/10
24 V AC/DC	no	red	105695	Ex9PB I r 24V AC/DC	1/10
36 V AC/DC	no	red	105696	Ex9PB I r 36V AC/DC	1/10
48 V AC/DC	no	red	105697	Ex9PB I r 48V AC/DC	1/10
110 V AC/DC	no	red	105698	Ex9PB I r 110V AC	1/10
230 V AC	no	red	105699	Ex9PB I r 230V AC	1/10
400 V AC	no	red	105700	Ex9PB I r 400V AC	1/10

## Interrupted blinking types

- Tone length 0.5 s, signal frequency 1 Hz, tone frequency 2300 Hz, noise level 75-105 dB
- Scope of delivery: complete device consisting of device body, internal sound and LED module, head cover



Rated voltage	Illuminated	Colour	Article No.	Type	Packing
24 V AC/DC	yes	red	105701	Ex9PB B r 24V AC/DC	1/10
36 V AC/DC	yes	red	105702	Ex9PB B r 36V AC/DC	1/10
48 V AC/DC	yes	red	105703	Ex9PB B r 48V AC/DC	1/10
110 V AC/DC	yes	red	105704	Ex9PB B r 110V AC	1/10
230 V AC	yes	red	105705	Ex9PB B r 230V AC	1/10
400 V AC	yes	red	105706	Ex9PB B r 400V AC	1/10



# Panel mounted buzzers Ex9PB

## Continuous types

- Tone frequency 2300 Hz, loudness 75-105 dB
- Scope of delivery: complete device consisting of device body, internal sound module, head cover



Rated voltage	Illuminated	Colour	Article No.	Type	Packing
24 V AC/DC	no	black	105707	Ex9PB C k 24V AC/DC	1/10
36 V AC/DC	no	black	105708	Ex9PB C k 36V AC/DC	1/10
48 V AC/DC	no	black	105709	Ex9PB C k 48V AC/DC	1/10
110 V AC/DC	no	black	105710	Ex9PB C k 110V AC	1/10
230 V AC	no	black	105711	Ex9PB C k 230V AC	1/10
400 V AC	no	black	105712	Ex9PB C k 400V AC	1/10
24 V AC/DC	no	red	105713	Ex9PB C r 24V AC/DC	1/10
36 V AC/DC	no	red	105714	Ex9PB C r 36V AC/DC	1/10
48 V AC/DC	no	red	105715	Ex9PB C r 48V AC/DC	1/10
110 V AC/DC	no	red	105716	Ex9PB C r 110V AC	1/10
230 V AC	no	red	105717	Ex9PB C r 230V AC	1/10
400 V AC	no	red	105718	Ex9PB C r 400V AC	1/10

## Continuous lighting types

- Tone frequency 2300 Hz, loudness 75-105 dB
- Scope of delivery: complete device consisting of device body, internal sound and LED module, head cover



Rated voltage	Illuminated	Colour	Article No.	Type	Packing
24 V AC/DC	yes	red	105719	Ex9PB L r 24V AC/DC	1/10
36 V AC/DC	yes	red	105720	Ex9PB L r 36V AC/DC	1/10
48 V AC/DC	yes	red	105721	Ex9PB L r 48V AC/DC	1/10
110 V AC/DC	yes	red	105722	Ex9PB L r 110V AC	1/10
230 V AC	yes	red	105723	Ex9PB L r 230V AC	1/10
400 V AC	yes	red	105724	Ex9PB L r 400V AC	1/10

# Panel mounted buzzers Ex9PB

## Position and function description labels

- Various versions of labels
- Holder and labels to be ordered separately
- Silver plastic material of stickers
- Self-adhesive - can be stuck onto the holder or inserted underneath of transparent cover
- Printing colour of standard and customer defined labels: black
- Customer defined variants of labels (ordering quantity as multiple of 7 pcs, printing can be different for every single piece)\*



Description	Article No.	Type	Packing
Holder for labels	106776	Ex9P1 S SH	1
<b>Label printing</b>			
Empty label (25x11 mm)	106777	Ex9P1 S S0	10
OFF - ON	106778	Ex9P1 S S1	10
0 - I	106779	Ex9P1 S S2	10
I - 0 - II	106780	Ex9P1 S S3	10
STOP - START	106781	Ex9P1 S S4	10
0 - 1	106782	Ex9P1 S S5	10
1 - 0 - 2	106783	Ex9P1 S S6	10
STOP	106784	Ex9P1 S S7	10
START	106785	Ex9P1 S S8	10
ON	106786	Ex9P1 S S9	10
OFF	106787	Ex9P1 S S10	10
RUN	106788	Ex9P1 S S11	10
AUTO	106789	Ex9P1 S S12	10
FAULT	106790	Ex9P1 S S13	10
Customer defined printing*	107876	Ex9P1 S S_USER	7

*\*) Ordering of customer defined stickers:*

- Order the item 107876
- Attach the information with requested sticker text and quantity of stickers with given content. Each sticker can be different
- Minimum ordering quantity is 7 pieces and multiples
- In case of graphic symbol to be produced, it is necessary to deliver source data (pdf, ai, jpg, png, etc.)
- Mention positioning of the sticker (standard horizontal, vertical)
- Maximum printable area is 10 x 24 mm (H x W)

# Technical Data

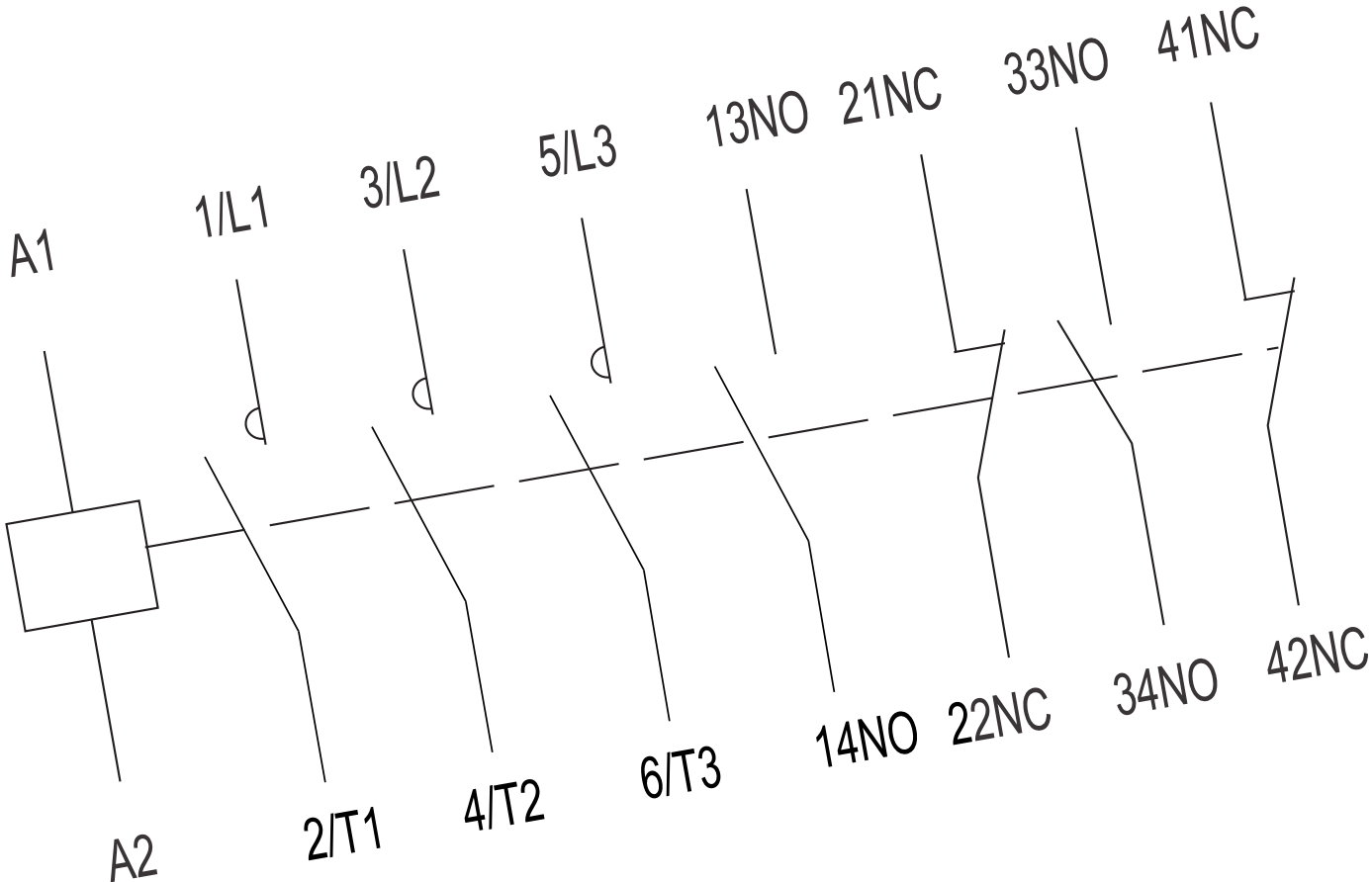

Technical data

# Content

## Technical Data

<b>Contactors and Relays</b>	
Ex9CS Miniature contactor .....	147
Ex9CSR Miniature reversible contactor .....	150
Ex9C Contactors up to 100 A .....	154
Ex9CR Reversible contactors .....	166
Ex9C Contactors up to 500 A .....	182
Ex9CC Capacitor contactors .....	194
Ex9JP Monitoring relays.....	197
Ex9JM Plug-in relays .....	200
<b>Motor Protective Circuit Breakers</b>	
Ex9S32A Motor protective circuit breakers .....	202
Ex9SN25B Motor protective circuit breakers .....	206
<b>Overload Thermal Relays</b>	
Ex9R Overload thermal relays up to 100 A .....	210
Ex9R Overload thermal relays up to 500 A .....	213
<b>Accessories for Industrial Devices</b>	
Accessories for contactors .....	216
Accessories for motor protective circuit breakers ..	227
Accessories for overload thermal relays .....	232
<b>Panel Mounted Devices</b>	
Ex9P1 Panel mounted control devices .....	236
Ex9P2FH Panel mounted control devices.....	242
Ex9IL Panel mounted signal lamps .....	244
Ex9PB Panel mounted buzzers .....	246

# Technical Data Ex9CS

## Miniature contactors Ex9CS06, Ex9CS09, Ex9CS12

### General parameters

Very compact dimensions		
Contactors rated at AC-3		
Suitable for industrial as well as domestic applications		
3 and 4-pole versions		
Mounting onto device rail (DIN) 35 mm or onto panel		
With or without built-in auxiliary contacts		
Accessories		
Front-mounted auxiliary contacts	AX41	101435, 101280, 101281, 101282, 101283
Surge suppression blocks	CCU41	104501, 104502, 104503
Mechanical interlocks	MIT41	107959

### Electrical parameters - main contacts and general

	Ex9CS06	Ex9CS09	Ex9CS12
Tested according to	IEC/EN 60947-4-1		
Rated operating voltage $U_e$	690 V AC		
Rated insulating voltage $U_i$	690 V AC		
Rated impulse withstand voltage $U_{imp}$	6 kV	6 kV	6 kV
Rated frequency	50/60 Hz		
Interlocked opposing contacts according to EN 60947-4-1, Annex L	yes	yes	yes
Conventional free air thermal current $I_{th}$	20 A	20 A	20 A
Rated operational current $I_e$			
AC-1	20 A	20 A	20 A
AC-2/AC-3/AC-4, 380/400 V	6 A	9 A	12 A
AC-2/AC-3/AC-4, 660/690 V	3.8 A	4.9 A	4.9 A
Rated power of 3-phase motor			
AC-3/AC-4, 380/400 V	2.2 kW	4 kW	5.5 kW
AC-3/AC-4, 660/690 V	3 kW	4 kW	4 kW
Maximum short circuit protection fuse			
Coordination type 1 at 500 V AC	25 A gG/gL	25 A gG/gL	25 A gG/gL
Coordination type 2 at 500 V AC	20 A gG/gL	20 A gG/gL	20 A gG/gL
Safe isolation (EN 61140)			
Main contact — main contact	400 V AC	400 V AC	400 V AC
Main contact — coil	400 V AC	400 V AC	400 V AC
3-phase power AC-1			
Maximum back-up fuse gG/gL	36 A	36 A	36 A
Power at 230/240 V	8 kW	8 kW	8 kW
Power at 380/400 V	13 kW	13 kW	13 kW
Power at 660/690 V	23 kW	23 kW	23 kW
Rated current $I_e = I_{th}$	20 A	20 A	20 A
1-phase power AC-1, 3 contacts in parallel			
Maximum back-up fuse gG/gL	63 A	63 A	63 A
Power at 230/240 V	18 kW	18 kW	18 kW
Power at 380/400 V	30 kW	30 kW	30 kW
Power at 660/690 V	51 kW	51 kW	51 kW
Rated current $I_e = I_{th}$	45 A	45 A	45 A

# Technical Data Ex9CS

## Miniature contactors Ex9CS06, Ex9CS09, Ex9CS12

### Electrical parameters - main contacts and general

	Ex9CS06	Ex9CS09	Ex9CS12
Making capacity			
230/240 V	144 A	144 A	144 A
380/400 V	144 A	144 A	144 A
660/690 V	144 A	144 A	144 A
Breaking capacity			
230/240 V	60 A	90 A	120 A
380/400 V	60 A	90 A	120 A
660/690 V	38 A	49 A	49 A
Mechanical service life	10 000 000 operation cycles		
Electrical service life 380/400 V			
AC-3	1 200 000 operation cycles		
AC-4	50 000 operation cycles	40 000 operation cycles	40 000 operation cycles
Overvoltage category	III		
EMC environment	A		
Comparative Tracking Index	400 V		
Prospective short circuit current $I_q$	50 kA		

### Electrical parameters - coil

	Ex9CS06	Ex9CS09	Ex9CS12
Control Voltage $U_c$	24, 36, 42, 48, 110, 127, 220, 230, 240, 380, 400, 415 V AC		
Tolerance of Control Voltage $U_c$	0.8 — 1.1 $U_c$	0.8 — 1.1 $U_c$	0.8 — 1.1 $U_c$
Frequency	50 Hz	50 Hz	50 Hz
Power consumption			
Pick-up	70 VA / 30 W	70 VA / 30 W	70 VA / 30 W
Hold	7.5 VA / 3 W	7.5 VA / 3 W	7.5 VA / 3 W
Duty	100 %	100 %	100 %
Closing delay	10 — 20 ms	10 — 20 ms	10 — 20 ms
Opening delay	4 — 16 ms	4 — 16 ms	4 — 16 ms
Closing delay with front-mounted AX	5 — 15 ms	5 — 15 ms	5 — 15 ms

### Electrical parameters - built-in auxiliary contacts

Rated operating voltage $U_e$	690 V AC
Rated insulating voltage $U_i$	690 V AC
Rated impulse withstand voltage $U_{imp}$	6 kV
Rated frequency	50 Hz
Interlocked opposing contacts according to EN 60947-4-1, Annex L	yes
Conventional free air thermal current $I_{th}$	10 A
Rated operational current $I_e$	
AC-15	6 A / 120 V, 3 A / 240 V, 1.9 A / 380 V, 1.5 A / 480 V, 1.2 A / 600 V
DC-13	0.55 A / 125 V, 0.27 A / 250 V
Max. back-up fuse	10 A gG/gL
Conditional short circuit current $I_k$ with max. back-up fuse	1 kA

# Technical Data Ex9CS

## Miniature contactors Ex9CS06, Ex9CS09, Ex9CS12

### Mechanical parameters

	Ex9CS06	Ex9CS09	Ex9CS12
Device width	45 mm		
Device height	59 mm including rail clip		
Device depth	58 mm (without front-mounted auxiliary contact)		
Mounting	easy fastening onto 35 mm device rail (DIN) or onto panel		
Degree of protection	IP20		
Terminals	lift		
Terminal capacity	1 — 2.5 mm <sup>2</sup>		
Fastening torque of terminals	0.7 — 0.8 Nm		
Ambient temperature	-20 — +60 °C		
Altitude	≤ 2000 m		
Relative humidity	≤ 95 %		
Resistance to humidity and heat	class 2		
Pollution degree	3		
Installation class	III		
Weight	0.18 kg	0.18 kg	0.18 kg
Power loss at $I_e$	0.2 W	0.2 W	0.2 W

### Dimensions

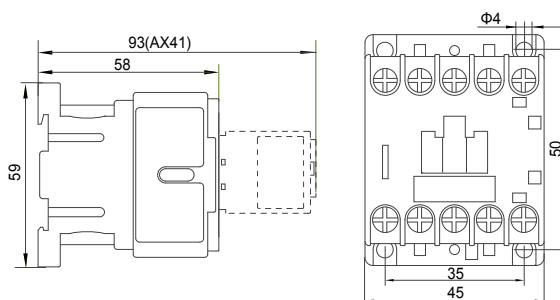

### Mounting positions

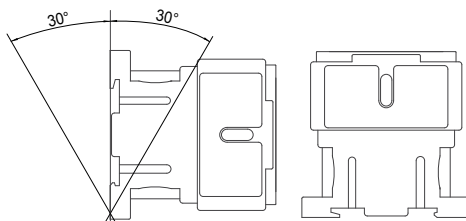

### Wiring diagrams

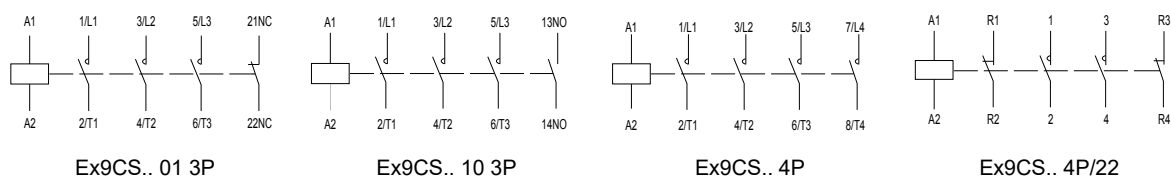

# Technical Data Ex9CSR

## Miniature reversible contactors Ex9CSR06, Ex9CSR09, Ex9CSR12

### General parameters

Very compact dimensions		
Contactors rated at AC-3		
Suitable for industrial as well as domestic applications		
3 and 4-pole versions		
Built-in mechanical interlock between particular contactors		
Mounting onto device rail (DIN) 35 mm or onto panel		
With or without built-in auxiliary contacts		
Accessories		
Front-mounted auxiliary contacts	AX41	101435, 101280, 101281, 101282, 101283
Surge suppressor block	CCU41	104501-104503

### Electrical parameters - main contacts and general

	Ex9CSR06	Ex9CSR09	Ex9CSR12
Tested according to	IEC/EN 60947-4-1		
Rated op. voltage $U_e$	690 V AC		
Rated insulating voltage $U_i$	690 V AC		
Rated impulse withstand voltage $U_{imp}$	6 kV	6 kV	6 kV
Rated frequency	50/60 Hz		
Interlocked opposing contacts according to EN 60947-4-1, Annex L	yes	yes	yes
Conventional free air thermal current $I_{th}$	20 A	20 A	20 A
Rated operational current $I_e$			
AC-1	20 A	20 A	20 A
AC-2/AC-3/AC-4, 380/400 V	6 A	9 A	12 A
AC-2/AC-3/AC-4, 660/690 V	3.8 A	4.9 A	4.9 A
Rated power of 3-phase motor			
AC-3/AC-4, 380/400 V	2.2 kW	4 kW	5.5 kW
AC-3/AC-4, 660/690 V	3 kW	4 kW	4 kW
Maximum short circuit protection fuse			
Coordination type 1 at 500 V AC	25 A gG/gL	25 A gG/gL	25 A gG/gL
Coordination type 2 at 500 V AC	20 A gG/gL	20 A gG/gL	20 A gG/gL
Safe isolation (EN 61140)			
Main contact — main contact	400 V AC	400 V AC	400 V AC
Main contact — coil	400 V AC	400 V AC	400 V AC
3-phase power AC-1			
Maximum back-up fuse gG/gL	36 A	36 A	36 A
Power at 230/240 V	8 kW	8 kW	8 kW
Power at 380/400 V	13 kW	13 kW	13 kW
Power at 660/690 V	23 kW	23 kW	23 kW
Rated current $I_e = I_{th}$	20 A	20 A	20 A
1-phase power AC-1, 3 contacts in parallel			
Maximum back-up fuse gG/gL	63 A	63 A	63 A
Power at 230/240 V	18 kW	18 kW	18 kW
Power at 380/400 V	30 kW	30 kW	30 kW
Power at 660/690 V	51 kW	51 kW	51 kW
Rated current $I_e = I_{th}$	45 A	45 A	45 A



# Technical Data Ex9CSR

## Miniature reversible contactors Ex9CSR06, Ex9CSR09, Ex9CSR12

### Electrical parameters - main contacts and general

	Ex9CSR06	Ex9CSR09	Ex9CSR12
Making capacity			
230/240 V	144 A	144 A	144 A
380/400 V	144 A	144 A	144 A
660/690 V	144 A	144 A	144 A
Breaking capacity			
230/240 V	60 A	90 A	120 A
380/400 V	60 A	90 A	120 A
660/690 V	38 A	49 A	49 A
Mechanical service life	10 000 000 operation cycles		
Electrical service life 380/400 V			
AC-3	1 200 000 operation cycles		
AC-4	50 000 operation cycles	40 000 operation cycles	40 000 operation cycles
Overvoltage category	III		
EMC environment	A		
Comparative Tracking Index	400 V		
Prospective short circuit current $I_q$	50 kA		

### Electrical parameters - coil

	Ex9CSR06	Ex9CSR09	Ex9CSR12
Control Voltage $U_c$	24, 36, 42, 48, 110, 127, 220, 230, 240, 380, 400, 415 V AC		
Tolerance of Control Voltage $U_c$	0.8 — 1.1 $U_c$	0.8 — 1.1 $U_c$	0.8 — 1.1 $U_c$
Frequency	50 Hz	50 Hz	50 Hz
Power consumption			
Pick-up	70 VA / 30 W	70 VA / 30 W	70 VA / 30 W
Hold	7.5 VA / 3 W	7.5 VA / 3 W	7.5 VA / 3 W
Duty	100 %	100 %	100 %
Closing delay	10 — 20 ms	10 — 20 ms	10 — 20 ms
Opening delay	4 — 16 ms	4 — 16 ms	4 — 16 ms
Closing delay with front-mounted AX	5 — 15 ms	5 — 15 ms	5 — 15 ms

### Electrical parameters - built-in auxiliary contacts

Rated op. voltage $U_e$	690 V AC
Rated insulating voltage $U_i$	690 V AC
Rated impulse withstand voltage $U_{imp}$	6 kV
Rated frequency	50 Hz
Interlocked opposing contacts according to EN 60947-4-1, Annex L	yes
Conventional free air thermal current $I_{th}$	10 A
Rated operational current $I_e$	
AC-15	6 A / 120 V, 3 A / 240 V, 1.9 A / 380 V, 1.5 A / 480 V, 1.2 A / 600 V
DC-13	0.55 A / 125 V, 0.27 A / 250 V
Max. back-up fuse	10 A gG/gL
Conditional short circuit current $I_k$ with max. back-up fuse	1 kA

# Technical Data Ex9CSR

## Miniature reversible contactors Ex9CSR06, Ex9CSR09, Ex9CSR12

### Mechanical parameters

	Ex9CSR06	Ex9CSR09	Ex9CSR12
Device width	90 mm		
Device height	59 mm (including rail clip)		
Device depth	58 mm (without front-mounted auxiliary contact)		
Mounting	easy fastening onto 35 mm device rail (DIN) or onto panel		
Degree of protection	IP20		
Terminals	lift		
Terminal capacity	1 — 2.5 mm <sup>2</sup>		
Fastening torque of terminals	0.7 — 0.8 Nm		
Ambient temperature	-20 — +60 °C		
Altitude	≤ 2000 m		
Relative humidity	≤ 95 %		
Resistance to humidity and heat	class 2		
Pollution degree	3		
Installation class	III		
Weight	0.37 kg	0.37 kg	0.37 kg
Power loss at $I_e$ (per contactor)	0.2 W	0.2 W	0.2 W

### Dimensions

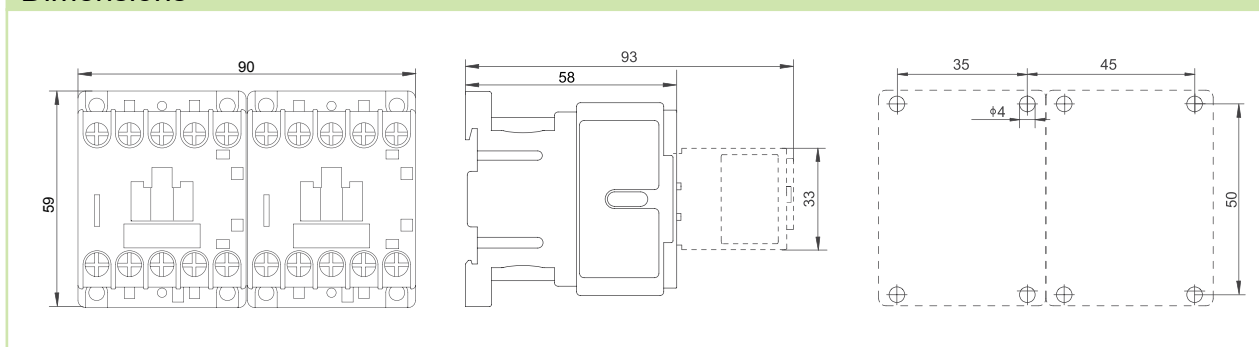

### Mounting positions

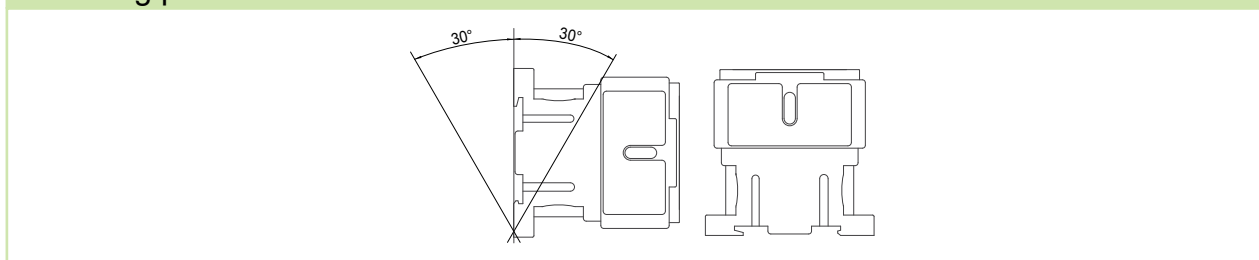

## Miniature reversible contactors Ex9CSR06, Ex9CSR09, Ex9CSR12

### Wiring diagrams

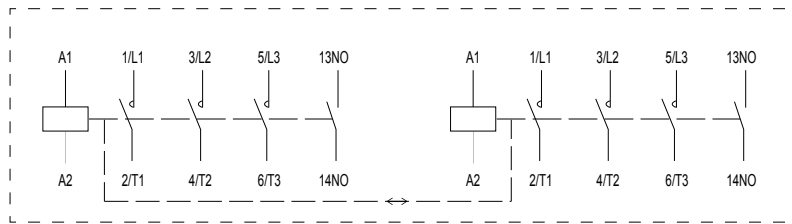

Ex9CSR 3P 1NO

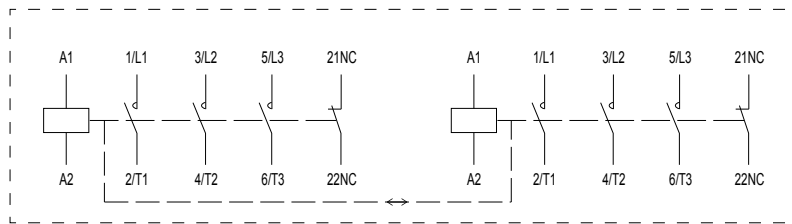

Ex9CSR 3P 1NC

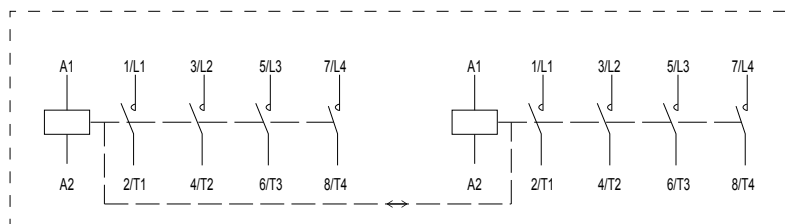

Ex9CSR 4P

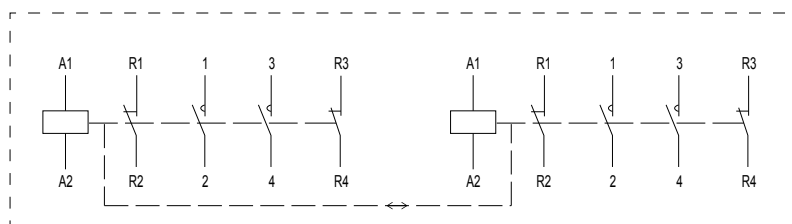

Ex9CSR 4P/22

# Technical Data Ex9C, frame size 18

## Contactors Ex9C09, Ex9C12, Ex9C18

### General parameters

Standard contactors rated at AC-3

Suitable mainly for industrial applications

Mounting onto device rail (DIN) 35 mm or onto panel

With built-in auxiliary contacts

Accessories

Front-mounted auxiliary contacts	AX42	101284 — 101291
Side-mounted auxiliary contacts	AX4311	101292
Surge suppressor blocks	CCU42	104498, 104499, 104500
Mechanical interlocks	MIT42	107960

### Electrical parameters - main contacts and general

	Ex9C09	Ex9C12	Ex9C18
Tested according to	IEC/EN 60947-4-1		
Rated operating voltage $U_e$	690 V AC		
Rated insulating voltage $U_i$	690 V AC		
Rated impulse withstand voltage $U_{imp}$	6 kV	6 kV	6 kV
Rated frequency	50/60 Hz		
Interlocked opposing contacts according to EN 60947-4-1, Annex L	yes	yes	yes
Conventional free air thermal current $I_{th}$	25 A	25 A	32 A
Rated operational current $I_e$			
AC-1	25 A	25 A	32 A
AC-2/AC-3/AC-4, 380/400 V	9 A	12 A	18 A
AC-3, 660/690 V	6.7 A	9 A	10.6 A
AC-2/AC-4, 660/690 V	4.9 A	4.9 A	6.7 A
Rated power of 3-phase motor			
AC-3/AC-4, 380/400 V	4 kW	5.5 kW	7.5 kW
AC-3, 660/690 V	5.5 kW	7.5 kW	9 kW
AC-4, 660/690 V	4 kW	4 kW	5.5 kW
Maximum short circuit protection fuse			
Coordination type 1 at 500 V AC	25 A gG/gL	40 A gG/gL	50 A gG/gL
Coordination type 2 at 500 V AC	20 A gG/gL	25 A gG/gL	36 A gG/gL
Safe isolation (EN 61140)			
Main contact — main contact	400 V AC	400 V AC	400 V AC
Main contact — coil	400 V AC	400 V AC	400 V AC
3-phase power AC-1			
Maximum back-up fuse gG/gL	50 A	50 A	63 A
Power at 230/240 V	10 kW	10 kW	13 kW
Power at 380/400 V	17 kW	17 kW	21 kW
Power at 660/690 V	29 kW	29 kW	37 kW
Rated current $I_e = I_{th}$	25 A	25 A	32 A
1-phase power AC-1, 3 contacts in parallel			
Maximum back-up fuse gG/gL	80 A	80 A	100 A
Power at 230/240 V	23 kW	23 kW	29 kW
Power at 380/400 V	37 kW	37 kW	48 kW
Power at 660/690 V	64 kW	64 kW	82 kW
Rated current $I_e = I_{th}$	56 A	56 A	72 A

# Technical Data Ex9C, frame size 18

## Contactors Ex9C09, Ex9C12, Ex9C18

### Electrical parameters - main contacts and general

	Ex9C09	Ex9C12	Ex9C18
Making capacity			
230/240 V	144 A	144 A	216 A
380/400 V	144 A	144 A	216 A
660/690 V	144 A	144 A	216 A
Breaking capacity			
230/240 V	90 A	120 A	180 A
380/400 V	90 A	120 A	180 A
660/690 V	67 A	90 A	106 A
Mechanical service life	10 000 000 operation cycles		
Electrical service life 380/400 V			
AC-3	1 200 000 operation cycles		
AC-4	50 000 operation cycles	40 000 operation cycles	40 000 operation cycles
Overvoltage category	III		
EMC environment	A		
Comparative Tracking Index	400 V		
Prospective short circuit current $I_q$	50 kA		

### Electrical parameters - coil

	Ex9C09	Ex9C12	Ex9C18
Control Voltage $U_c$	24, 36, 42, 48, 110, 127, 220, 230, 240, 380, 400, 415 V AC		
Tolerance of Control Voltage $U_c$	0.8 — 1.1 $U_c$	0.8 — 1.1 $U_c$	0.8 — 1.1 $U_c$
Frequency	50 Hz	50 Hz	50 Hz
Power consumption			
Pick-up	90 VA / 40 W	90 VA / 40 W	90 VA / 40 W
Hold	9.5 VA / 4 W	9.5 VA / 4 W	9.5 VA / 4 W
Duty	100 %	100 %	100 %
Closing delay	12 — 24 ms	12 — 24 ms	12 — 24 ms
Opening delay	6 — 20 ms	6 — 20 ms	6 — 20 ms
Closing delay with front-mounted AX	8 — 18 ms	8 — 18 ms	8 — 18 ms

### Electrical parameters - built-in auxiliary contacts

Rated operating voltage $U_e$	690 V AC
Rated insulating voltage $U_i$	690 V AC
Rated impulse withstand voltage $U_{imp}$	6 kV
Rated frequency	50 Hz
Interlocked opposing contacts according to EN 60947-4-1, Annex L	yes
Conventional free air thermal current $I_{th}$	10 A
Rated operational current $I_e$	
AC-15	6 A / 120 V, 3 A / 240 V, 1.9 A / 380 V, 1.5 A / 480 V, 1.2 A / 600 V
DC-13	0.55 A / 125 V, 0.27 A / 250 V
Max. back-up fuse	10 A gG/gL
Conditional short circuit current $I_k$ with max. back-up fuse	1 kA

# Technical Data Ex9C, frame size 18

## Contactors Ex9C09, Ex9C12, Ex9C18

### Mechanical parameters

	Ex9C09	Ex9C12	Ex9C18
Device width	45 mm (without side-mounted auxiliary contact)		
Device height	89 mm including rail clip		
Device depth	94 mm (without front-mounted auxiliary contact)		
Mounting	easy fastening onto 35 mm device rail (DIN) or onto panel		
Degree of protection	IP20		
Terminals	lift		
Terminal capacity	(1 — 2) x (1.5 — 6 mm <sup>2</sup> ) wired; 1 x (1 — 6 mm <sup>2</sup> ), 2 x (1 — 4 mm <sup>2</sup> ) solid		
Fastening torque of terminals	1.5 — 1.7 Nm		
Ambient temperature	-20 — +60 °C		
Altitude	≤ 2000 m		
Relative humidity	≤ 95 %		
Resistance to humidity and heat	class 2		
Pollution degree	3		
Installation class	III		
Weight	0.35 kg	0.35 kg	0.35 kg
Power loss at $I_e$	0.2 W	0.36 W	0.8 W

### Dimensions

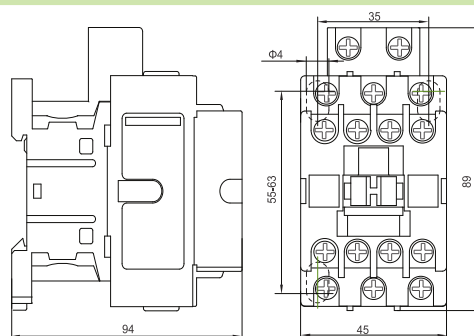

### Mounting positions

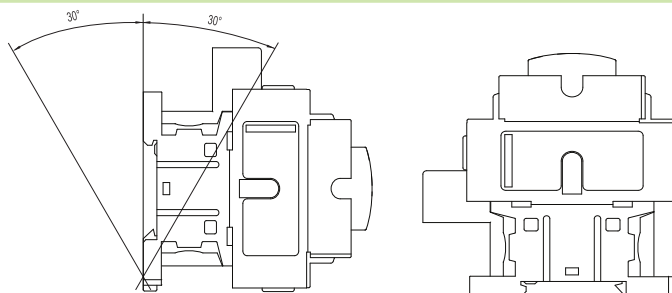

### Wiring diagrams

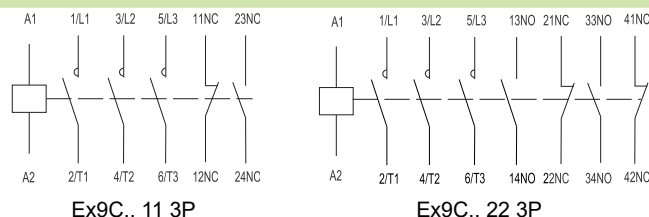

# Technical Data Ex9C, frame size 38

## Contactors Ex9C25, Ex9C32, Ex9C38

### General parameters

Standard contactors rated at AC-3

Suitable mainly for industrial applications

Mounting onto device rail (DIN) 35 mm or onto panel

With built-in auxiliary contacts

Accessories

Front-mounted auxiliary contacts	AX42	101284 — 101291
Side-mounted auxiliary contacts	AX4311	101292
Surge suppressor block	CCU42	104498, 104499, 104500
Mechanical interlocks	MIT42	107960

### Electrical parameters - main contacts and general

	Ex9C25	Ex9C32	Ex9C38
Tested according to	IEC/EN 60947-4-1		
Rated operating voltage $U_e$	690 V AC		
Rated insulating voltage $U_i$	690 V AC		
Rated impulse withstand voltage $U_{imp}$	6 kV	6 kV	6 kV
Rated frequency	50/60 Hz		
Interlocked opposing contacts according to EN 60947-4-1, Annex L	yes	yes	yes
Conventional free air thermal current $I_{th}$	40 A	50 A	50 A
Rated operational current $I_e$			
AC-1	40 A	50 A	50 A
AC-2/AC-3/AC-4, 380/400 V	25 A	32 A	38 A
AC-3, 660/690 V	17.3 A	21.9 A	21.9 A
AC-2/AC-4, 660/690 V	14 A	17.3 A	17.3 A
Rated power of 3-phase motor			
AC-3/AC-4, 380/400 V	11 kW	15 kW	18.5 kW
AC-3, 660/690 V	15 kW	18.5 kW	18.5 kW
AC-4, 660/690 V	11 kW	15 kW	15 kW
Maximum short circuit protection fuse			
Coordination type 1 at 500 V AC	63 A gG/gL	63 A gG/gL	63 A gG/gL
Coordination type 2 at 500 V AC	40 A gG/gL	63 A gG/gL	63 A gG/gL
Safe isolation (EN 61140)			
Main contact — main contact	400 V AC	400 V AC	400 V AC
Main contact — coil	400 V AC	400 V AC	400 V AC
3-phase power AC-1			
Maximum back-up fuse gG/gL	80 A	100 A	100 A
Power at 230/240 V	16 kW	20 kW	20 kW
Power at 380/400 V	26 kW	33 kW	33 kW
Power at 660/690 V	46 kW	57 kW	57 kW
Rated current $I_e = I_{th}$	40 A	50 A	50 A
1-phase power AC-1, 3 contacts in parallel			
Maximum back-up fuse gG/gL	160 A	160 A	160 A
Power at 230/240 V	34 kW	42 kW	42 kW
Power at 380/400 V	55 kW	69 kW	69 kW
Power at 660/690 V	96 kW	120 kW	120 kW
Rated current $I_e = I_{th}$	84 A	105 A	105 A

# Technical Data Ex9C, frame size 38

## Contactors Ex9C25, Ex9C32, Ex9C38

### Electrical parameters - main contacts and general

	Ex9C25	Ex9C32	Ex9C38
Making capacity			
230/240 V	300 A	384 A	456 A
380/400 V	300 A	384 A	456 A
660/690 V	300 A	384 A	456 A
Breaking capacity			
230/240 V	250 A	320 A	320 A
380/400 V	250 A	320 A	320 A
660/690 V	173 A	219 A	219 A
Mechanical service life	10 000 000 operation cycles		
Electrical service life 380/400 V			
AC-3	1 200 000 operation cycles		
AC-4	50 000 operation cycles	40 000 operation cycles	40 000 operation cycles
Overvoltage category	III		
EMC environment	A		
Comparative Tracking Index	400 V		
Prospective short circuit current $I_q$	50 kA		

### Electrical parameters - coil

	Ex9C25	Ex9C32	Ex9C38
Control Voltage $U_c$	24, 36, 42, 48, 110, 127, 220, 230, 240, 380, 400, 415 V AC		
Tolerance of Control Voltage $U_c$	0.8 — 1.1 $U_c$	0.8 — 1.1 $U_c$	0.8 — 1.1 $U_c$
Frequency	50 Hz	50 Hz	50 Hz
Power consumption			
Pick-up	100 VA / 50 W	100 VA / 50 W	100 VA / 50 W
Hold	10.5 VA / 5 W	10.5 VA / 5 W	10.5 VA / 5 W
Duty	100 %	100 %	100 %
Closing delay	14 — 27 ms	14 — 27 ms	14 — 27 ms
Opening delay	7 — 22 ms	7 — 22 ms	7 — 22 ms
Closing delay with front-mounted AX	9 — 20 ms	9 — 20 ms	9 — 20 ms

### Electrical parameters - built-in auxiliary contacts

Rated operating voltage $U_e$	690 V AC
Rated insulating voltage $U_i$	690 V AC
Rated impulse withstand voltage $U_{imp}$	6 kV
Rated frequency	50 Hz
Interlocked opposing contacts according to EN 60947-4-1, Annex L	yes
Conventional free air thermal current $I_{th}$	10 A
Rated operational current $I_e$	
AC-15	6 A / 120 V, 3 A / 240 V, 1.9 A / 380 V, 1.5 A / 480 V, 1.2 A / 600 V
DC-13	0.55 A / 125 V, 0.27 A / 250 V
Max. back-up fuse	10 A gG/gL
Conditional short circuit current $I_k$ with max. back-up fuse	1 kA



# Technical Data Ex9C, frame size 38

## Contactors Ex9C25, Ex9C32, Ex9C38

### Mechanical parameters

	Ex9C25	Ex9C32	Ex9C38
Device width	45 mm (without side-mounted auxiliary contact)		
Device height	100 mm including rail clip		
Device depth	108 mm (without front-mounted auxiliary contact)		
Mounting	easy fastening onto 35 mm device rail (DIN) or onto panel		
Degree of protection	IP20		
Terminals	lift		
Terminal capacity	(1 — 2) x (2.5 — 10 mm <sup>2</sup> ) wired; 1 x (1 — 10 mm <sup>2</sup> ), 2 x (1.5 — 6 mm <sup>2</sup> ) solid		
Fastening torque of terminals	2 — 2.5 Nm		
Ambient temperature	-20 — +60 °C		
Altitude	≤ 2000 m		
Relative humidity	≤ 95 %		
Resistance to humidity and heat	class 2		
Pollution degree	3		
Installation class	III		
Weight	0.4 kg	0.4 kg	0.4 kg
Power loss at $I_e$	1.25 W	2 W	3 W

### Dimensions

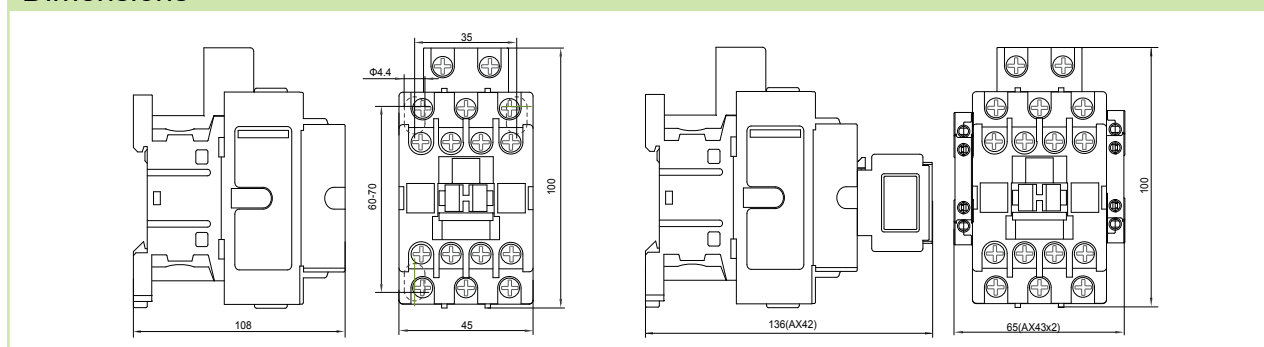

### Mounting positions

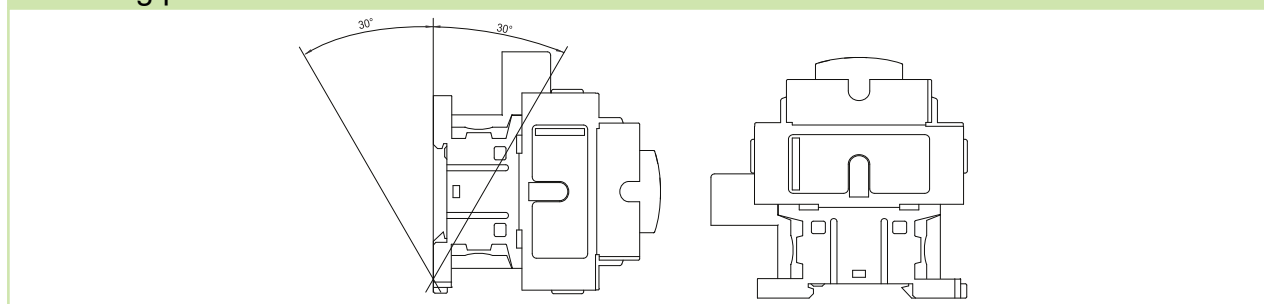

### Wiring diagrams

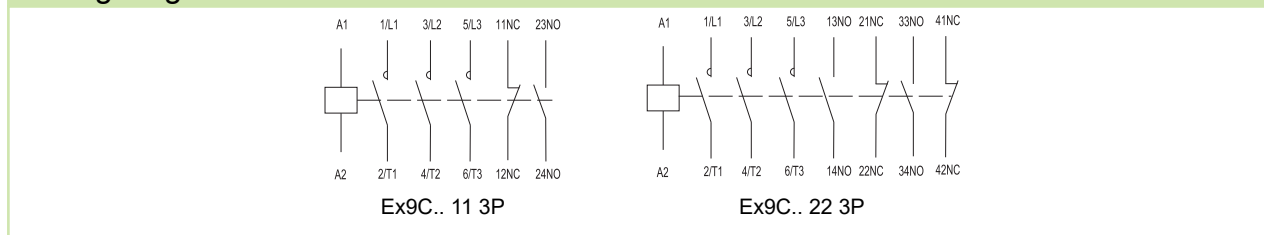

# Technical Data Ex9C, frame size 65

## Contactors Ex9C40, Ex9C50, Ex9C65

### General parameters

Standard contactors		
Contactors rated at AC-3		
Suitable mainly for industrial applications		
Mounting onto device rail (DIN) 35 mm and 75 mm or onto panel		
With built-in auxiliary contacts		
Accessories		
Front-mounted auxiliary contacts	AX42	101284 — 101291
Side-mounted auxiliary contacts	AX4311	101292
Surge suppressor block	CCU43	104495, 104496, 104497
Mechanical interlocks	MIT43	107961

### Electrical parameters - main contacts and general

	Ex9C40	Ex9C50	Ex9C65
Tested according to	IEC/EN 60947-4-1		
Rated op. voltage $U_e$	690 V AC		
Rated insulating voltage $U_i$	1000 V AC		
Rated impulse withstand voltage $U_{imp}$	6 kV	6 kV	6 kV
Rated frequency	50/60 Hz		
Interlocked opposing contacts according to EN 60947-4-1, Annex L	yes	yes	yes
Conventional free air thermal current $I_{th}$	60 A	80 A	80 A
Rated operational current $I_e$			
AC-1	60 A	80 A	80 A
AC-2/AC-3/AC-4, 380/400 V	40 A	50 A	65 A
AC-2/AC-3/AC-4, 660/690 V	34 A	39 A	42 A
Rated power of 3-phase motor			
AC-3/AC-4, 380/400 V	18.5 kW	22 kW	30 kW
AC-3/AC-4, 660/690 V	30 kW	33 kW	37 kW
Maximum short circuit protection fuse			
Coordination type 1 at 500 V AC	80 A gG/gL	100 A gG/gL	160 A gG/gL
Coordination type 2 at 500 V AC	80 A gG/gL	100 A gG/gL	125 A gG/gL
Safe isolation (EN 61140)			
Main contact — main contact	690 V AC	690 V AC	690 V AC
Main contact — coil	690 V AC	690 V AC	690 V AC
3-phase power AC-1			
Maximum back-up fuse gG/gL	125 A	160 A	160 A
Power at 230/240 V	24 kW	32 kW	32 kW
Power at 380/400 V	40 kW	53 kW	53 kW
Power at 660/690 V	69 kW	92 kW	92 kW
Rated current $I_e = I_{th}$	60 A	80 A	80 A
1-phase power AC-1, 3 contacts in parallel			
Maximum back-up fuse gG/gL	200 A	250 A	250 A
Power at 230/240 V	50 kW	67 kW	67 kW
Power at 380/400 V	83 kW	110 kW	110 kW
Power at 660/690 V	144 kW	192 kW	192 kW
Rated current $I_e = I_{th}$	126 A	168 A	168 A

# Technical Data Ex9C, frame size 65

## Contactors Ex9C40, Ex9C50, Ex9C65

### Electrical parameters - main contacts and general

	Ex9C40	Ex9C50	Ex9C65
Making capacity			
230/240 V	480 A	600 A	780 A
380/400 V	480 A	600 A	780 A
660/690 V	480 A	600 A	780 A
Breaking capacity			
230/240 V	400 A	500 A	650 A
380/400 V	400 A	500 A	650 A
660/690 V	340 A	390 A	420 A
Mechanical service life	10 000 000 operation cycles		
Electrical service life 380/400 V			
AC-3	1 200 000 operation cycles		
AC-4	35 000 operation cycles	30 000 operation cycles	30 000 operation cycles
Overvoltage category	III		
EMC environment	A		
Comparative Tracking Index	400 V		
Prospective short circuit current $I_q$	50 kA		

### Electrical parameters - coil

	Ex9C40	Ex9C50	Ex9C65
Control Voltage $U_c$	24, 36, 42, 48, 110, 127, 220, 230, 240, 380, 400, 415 V AC		
Tolerance of Control Voltage $U_c$	0.8 — 1.1 $U_c$	0.8 — 1.1 $U_c$	0.8 — 1.1 $U_c$
Frequency	50 Hz	50 Hz	50 Hz
Power consumption			
Pick-up	240 VA / 100 W	240 VA / 100 W	240 VA / 100 W
Hold	25 VA / 10 W	25 VA / 10 W	25 VA / 10 W
Duty	100 %	100 %	100 %
Closing delay	20 — 30 ms	20 — 30 ms	20 — 30 ms
Opening delay	8 — 20 ms	8 — 20 ms	8 — 20 ms
Closing delay with front-mounted AX	12 — 25 ms	12 — 25 ms	12 — 25 ms

### Electrical parameters - built-in auxiliary contacts

Rated op. voltage $U_e$	690 V AC
Rated insulating voltage $U_i$	690 V AC
Rated impulse withstand voltage $U_{imp}$	6 kV
Rated frequency	50 Hz
Interlocked opposing contacts according to EN 60947-4-1, Annex L	yes
Conventional free air thermal current $I_{th}$	10 A
Rated operational current $I_e$	
AC-15	6 A / 120 V, 3 A / 240 V, 1.9 A / 380 V, 1.5 A / 480 V, 1.2 A / 600 V
DC-13	0.55 A / 125 V, 0.27 A / 250 V
Max. back-up fuse	10 A gG/gL
Conditional short circuit current $I_k$ with max. back-up fuse	1 kA

# Technical Data Ex9C, frame size 65

## Contactors Ex9C40, Ex9C50, Ex9C65

### Mechanical parameters

	Ex9C40	Ex9C50	Ex9C65
Device width	76 mm (without side-mounted auxiliary contact)		
Device height	122 mm including rail clip		
Device depth	123 mm (without front-mounted auxiliary contact)		
Mounting	easy fastening onto 35 or 75 mm device rail (DIN) or onto panel		
Degree of protection	IP20		
Terminals	lift		
Terminal capacity	(1 — 2) x (2.5 — 25 mm <sup>2</sup> )		
Fastening torque of terminals	5.5 — 6 Nm		
Ambient temperature	-20 — +60 °C		
Altitude	≤ 2000 m		
Relative humidity	≤ 95 %		
Resistance to humidity and heat	class 2		
Pollution degree	3		
Installation class	III		
Weight	1.23 kg	1.23 kg	1.23 kg
Power loss at $I_e$	2.4 W	3.7 W	4.2 W

### Dimensions

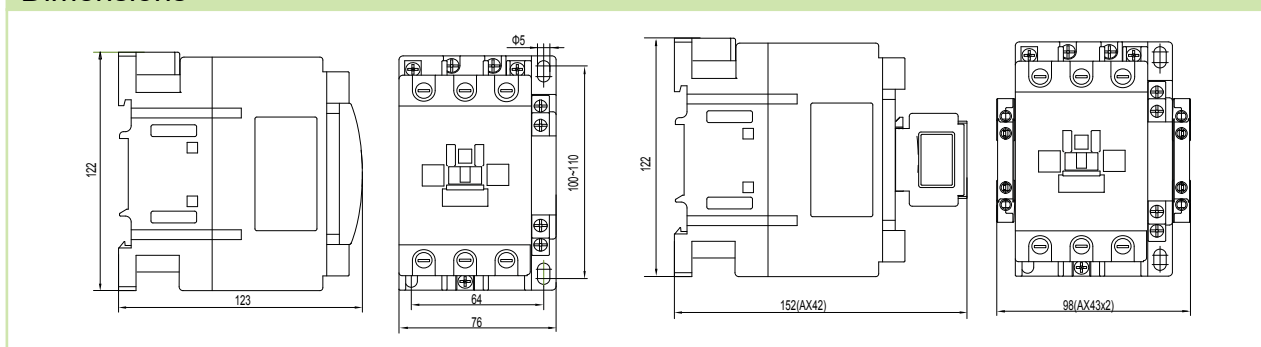

### Mounting positions

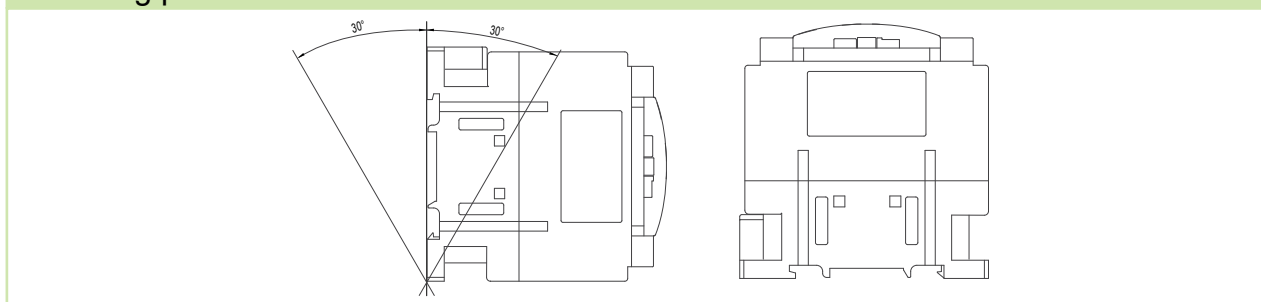

### Wiring diagram

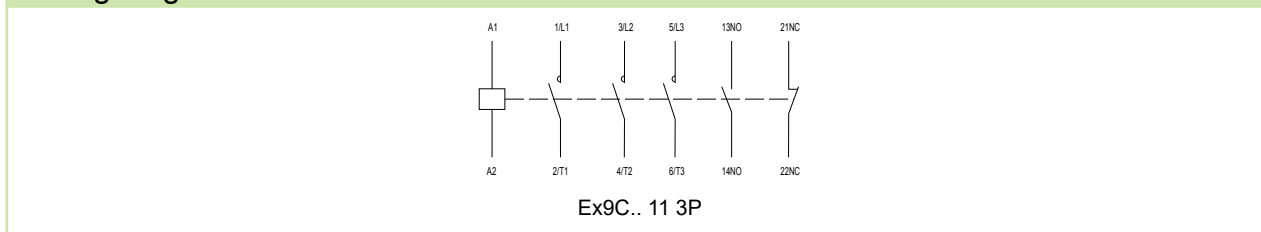

# Technical Data Ex9C, frame size 100

## Contactors Ex9C80, Ex9C100

### General parameters

Standard contactors		
Contactors rated at AC-3		
Suitable mainly for industrial applications		
Mounting onto device rail (DIN) 35 mm and 75 mm or onto panel		
With built-in auxiliary contacts		
Accessories		
Front-mounted auxiliary contacts	AX42	101284 — 101291
Side-mounted auxiliary contacts	AX4311	101292
Surge suppressor block	CCU43	104495, 104496, 104497
Mechanical interlocks	MIT43	107961

### Electrical parameters - main contacts and general

	Ex9C80	Ex9C100
Tested according to	IEC/EN 60947-4-1	
Rated op. voltage $U_e$	690 V AC	
Rated insulating voltage $U_i$	1000 V AC	
Rated impulse withstand voltage $U_{imp}$	6 kV	6 kV
Rated frequency	50/60 Hz	
Interlocked opposing contacts according to EN 60947-4-1, Annex L	yes	yes
Conventional free air thermal current $I_{th}$	125 A	125 A
Rated operational current $I_e$		
AC-1	125 A	125 A
AC-2/AC-3/AC-4, 380/400 V	80 A	100 A
AC-2/AC-3/AC-4, 660/690 V	49 A	49 A
Rated power of 3-phase motor		
AC-3/AC-4, 380/400 V	37 kW	45 kW
AC-3/AC-4, 660/690 V	45 kW	45 kW
Maximum short circuit protection fuse		
Coordination type 1 at 500 V AC	200 A gG/gL	200 A gG/gL
Coordination type 2 at 500 V AC	160 A gG/gL	160 A gG/gL
Safe isolation (EN 61140)		
Main contact — main contact	690 V AC	690 V AC
Main contact — coil	690 V AC	690 V AC
3-phase power AC-1		
Maximum back-up fuse gG/gL	250 A	250 A
Power at 230/240 V	50 kW	50 kW
Power at 380/400 V	82 kW	82 kW
Power at 660/690 V	143 kW	143 kW
Rated current $I_e = I_{th}$	125 A	125 A
1-phase power AC-1, 3 contacts in parallel		
Maximum back-up fuse gG/gL	400 A	400 A
Power at 230/240 V	105 kW	105 kW
Power at 380/400 V	172 kW	172 kW
Power at 660/690 V	300 kW	300 kW
Rated current $I_e = I_{th}$	262 A	262 A

# Technical Data Ex9C, frame size 100

## Contactors Ex9C80, Ex9C100

### Electrical parameters - main contacts and general

	Ex9C80	Ex9C100
Making capacity		
230/240 V	960 A	1200 A
380/400 V	960 A	1200 A
660/690 V	960 A	1200 A
Breaking capacity		
230/240 V	800 A	1000 A
380/400 V	800 A	1000 A
660/690 V	490 A	490 A
Mechanical service life	10 000 000 operation cycles	
Electrical service life 380/400 V		
AC-3	1 200 000 operation cycles	
AC-4	25 000 operation cycles	25 000 operation cycles
Overvoltage category	III	
EMC environment	A	
Comparative Tracking Index	400 V	
Prospective short circuit current $I_q$	50 kA	

### Electrical parameters - coil

	Ex9C80	Ex9C100
Control Voltage $U_c$	24, 36, 42, 48, 110, 127, 220, 230, 240, 380, 400, 415 V AC	
Tolerance of Control Voltage $U_c$	0.8 — 1.1 $U_c$	
Frequency	50 Hz	
Power consumption		
Pick-up	280 VA / 120 W	280 VA / 120 W
Hold	30 VA / 12 W	30 VA / 12 W
Duty	100 %	
Closing delay	20 — 35 ms	
Opening delay	6 — 20 ms	
Closing delay with front-mounted AX	12 — 30 ms	

### Electrical parameters - built-in auxiliary contacts

Rated op. voltage $U_e$	690 V AC
Rated insulating voltage $U_i$	690 V AC
Rated impulse withstand voltage $U_{imp}$	6 kV
Rated frequency	50 Hz
Interlocked opposing contacts according to EN 60947-4-1, Annex L	yes
Conventional free air thermal current $I_{th}$	10 A
Rated operational current $I_e$	
AC-15	6 A / 120 V, 3 A / 240 V, 1.9 A / 380 V, 1.5 A / 480 V, 1.2 A / 600 V
DC-13	0.55 A / 125 V, 0.27 A / 250 V
Max. back-up fuse	10 A gG/gL
Conditional short circuit current $I_k$ with max. back-up fuse	1 kA

# Technical Data Ex9C, frame size 100

## Contactors Ex9C80, Ex9C100

### Mechanical parameters

	Ex9C80	Ex9C100
Device width	87 mm (without side-mounted auxiliary contact)	
Device height	130 mm including rail clip	
Device depth	130 mm (without front-mounted auxiliary contact)	
Mounting	easy fastening onto 35 or 75 mm device rail (DIN) or onto panel	
Degree of protection	IP20	
Terminals	lift	
Terminal capacity	(1 — 2) x (4 — 50 mm <sup>2</sup> )	
Fastening torque of terminals	5.5 — 6 Nm	
Ambient temperature	-20 — +60 °C	
Altitude	≤ 2000 m	
Relative humidity	≤ 95 %	
Resistance to humidity and heat	class 2	
Pollution degree	3	
Installation class	III	
Weight	1.5 kg	1.5 kg
Power loss at $I_e$	5.1 W	7.5 W

### Dimensions

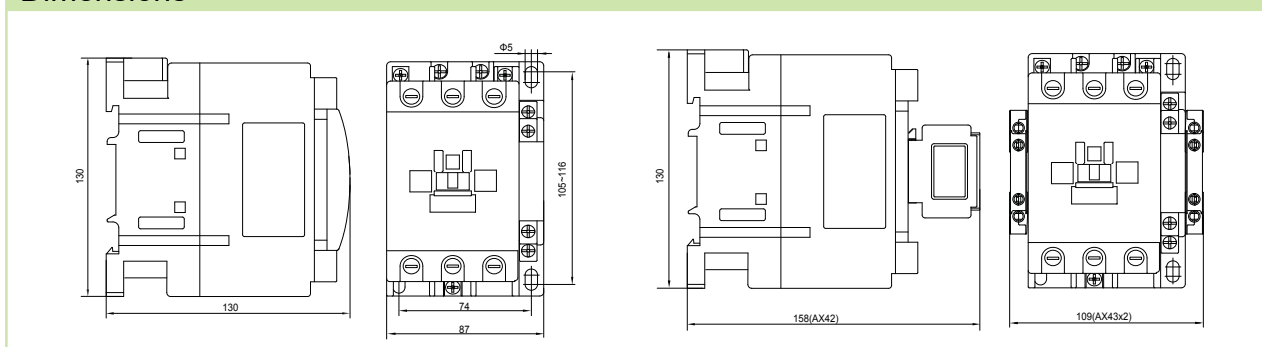

### Mounting positions

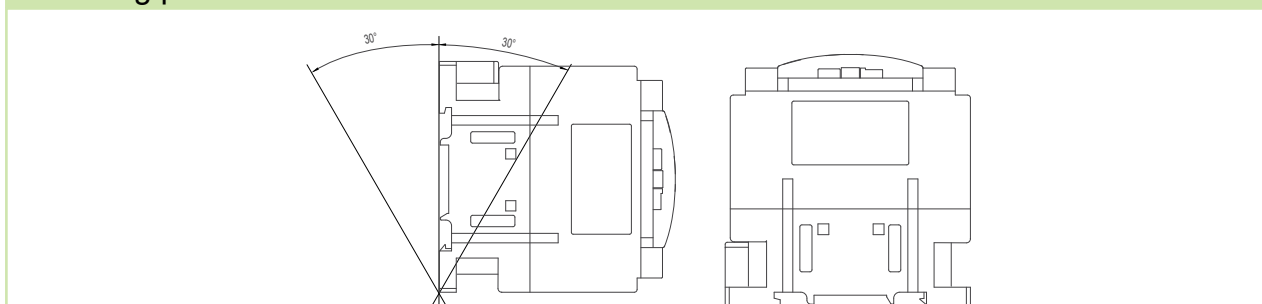

### Wiring diagram

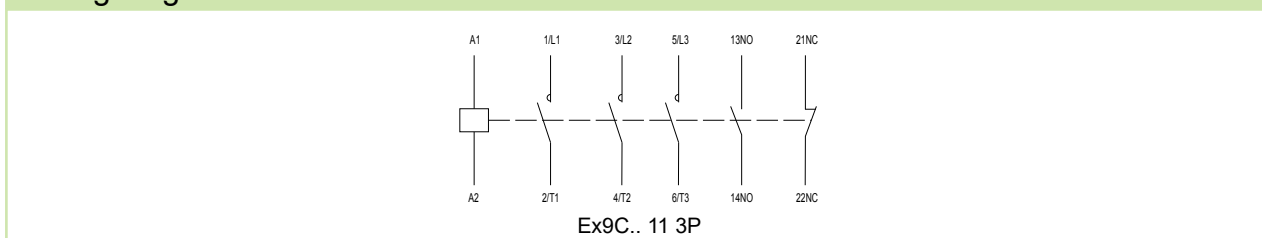

# Technical Data Ex9CR, frame size 18

## Reversible contactors Ex9CR09, Ex9CR12, Ex9CR18

### General parameters

Reversible combinations of contactors rated at AC-3

Suitable mainly for industrial applications

3-pole versions

Built-in mechanical interlock between particular contactors

With built-in auxiliary contacts

Accessories

Front-mounted auxiliary contacts	AX42	101284 — 101291
Side-mounted auxiliary contacts	AX4311	101292
Surge suppressor block	CCU42	104498, 104499, 104500

### Electrical parameters - main contacts and general

	Ex9CR09	Ex9CR12	Ex9CR18
Tested according to	IEC/EN 60947-4-1		
Rated op. voltage $U_e$	690 V AC		
Rated insulating voltage $U_i$	690 V AC		
Rated impulse withstand voltage $U_{imp}$	6 kV	6 kV	6 kV
Rated frequency	50/60 Hz		
Interlocked opposing contacts according to EN 60947-4-1, Annex L	yes	yes	yes
Conventional free air thermal current $I_{th}$	25 A	25 A	32 A
Rated operational current $I_e$			
AC-1	25 A	25 A	32 A
AC-2/AC-3/AC-4, 380/400 V	9 A	12 A	18 A
AC-3, 660/690 V	6.7 A	9 A	10.6 A
AC-2/AC-4, 660/690 V	4.9 A	4.9 A	6.7 A
Rated power of 3-phase motor			
AC-3/AC-4, 380/400 V	4 kW	5.5 kW	7.5 kW
AC-3, 660/690 V	5.5 kW	7.5 kW	9 kW
AC-4, 660/690 V	4 kW	4 kW	5.5 kW
Maximum short circuit protection fuse			
Coordination type 1 at 500 V AC	25 A gG/gL	40 A gG/gL	50 A gG/gL
Coordination type 2 at 500 V AC	20 A gG/gL	25 A gG/gL	36 A gG/gL
Safe isolation (EN 61140)			
Main contact — main contact	400 V AC	400 V AC	400 V AC
Main contact — coil	400 V AC	400 V AC	400 V AC
3-phase power AC-1			
Maximum back-up fuse gG/gL	50 A	50 A	63 A
Power at 230/240 V	10 kW	10 kW	13 kW
Power at 380/400 V	17 kW	17 kW	21 kW
Power at 660/690 V	29 kW	29 kW	37 kW
Rated current $I_e = I_{th}$	25 A	25 A	32 A
1-phase power AC-1, 3 contacts in parallel			
Maximum back-up fuse gG/gL	80 A	80 A	100 A
Power at 230/240 V	23 kW	23 kW	29 kW
Power at 380/400 V	37 kW	37 kW	48 kW
Power at 660/690 V	64 kW	64 kW	82 kW
Rated current $I_e = I_{th}$	56 A	56 A	72 A



# Technical Data Ex9CR, frame size 18

## Reversible contactors Ex9CR09, Ex9CR12, Ex9CR18

### Electrical parameters - main contacts and general

	Ex9CR09	Ex9CR12	Ex9CR18
Making capacity			
230/240 V	144 A	144 A	216 A
380/400 V	144 A	144 A	216 A
660/690 V	144 A	144 A	216 A
Breaking capacity			
230/240 V	90 A	120 A	180 A
380/400 V	90 A	120 A	180 A
660/690 V	67 A	90 A	106 A
Mechanical service life	10 000 000 operation cycles		
Electrical service life 380/400 V			
AC-3	1 200 000 operation cycles		
AC-4	50 000 operation cycles	40 000 operation cycles	40 000 operation cycles
Overvoltage category	III		
EMC environment	A		
Comparative Tracking Index	400 V		
Prospective short circuit current $I_q$	50 kA		

### Electrical parameters - coil

	Ex9CR09	Ex9CR12	Ex9CR18
Control Voltage $U_c$	24, 36, 42, 48, 110, 127, 220, 230, 240, 380, 400, 415 V AC		
Tolerance of Control Voltage $U_c$	0.8 — 1.1 $U_c$	0.8 — 1.1 $U_c$	0.8 — 1.1 $U_c$
Frequency	50 Hz	50 Hz	50 Hz
Power consumption			
Pick-up	90 VA / 40 W	90 VA / 40 W	90 VA / 40 W
Hold	9.5 VA / 4 W	9.5 VA / 4 W	9.5 VA / 4 W
Duty	100 %	100 %	100 %
Closing delay	12 — 24 ms	12 — 24 ms	12 — 24 ms
Opening delay	6 — 20 ms	6 — 20 ms	6 — 20 ms
Closing delay with front-mounted AX	8 — 18 ms	8 — 18 ms	8 — 18 ms

### Electrical parameters - built-in auxiliary contacts

Rated op. voltage $U_e$	690 V AC
Rated insulating voltage $U_i$	690 V AC
Rated impulse withstand voltage $U_{imp}$	6 kV
Rated frequency	50 Hz
Interlocked opposing contacts according to EN 60947-4-1, Annex L	yes
Conventional free air thermal current $I_{th}$	10 A
Rated operational current $I_e$	
AC-15	6 A / 120 V, 3 A / 240 V, 1.9 A / 380 V, 1.5 A / 480 V, 1.2 A / 600 V
DC-13	0.55 A / 125 V, 0.27 A / 250 V
Max. back-up fuse	10 A gG/gL
Conditional short circuit current $I_k$ with max. back-up fuse	1 kA

# Technical Data Ex9CR, frame size 18

## Reversible contactors Ex9CR09, Ex9CR12, Ex9CR18

### Mechanical parameters

	Ex9CR09	Ex9CR12	Ex9CR18
Device width	99 mm		
Device height	89 mm (including rail clip)		
Device depth	94 mm (without front-mounted auxiliary contact)		
Mounting	easy fastening onto 35 mm device rail (DIN) or onto panel		
Degree of protection	IP20		
Terminals	lift		
Terminal capacity	(1 — 2) x (1.5 — 6 mm <sup>2</sup> ) wired; 1 x (1 — 6 mm <sup>2</sup> ), 2 x (1 — 4 mm <sup>2</sup> ) solid		
Fastening torque of terminals	1.5 — 1.7 Nm		
Ambient temperature	-20 — +60 °C		
Altitude	≤ 2000 m		
Relative humidity	≤ 95 %		
Resistance to humidity and heat	class 2		
Pollution degree	3		
Installation class	III		
Weight	0.72 kg	0.72 kg	0.72 kg
Power loss at $I_e$ (per contactor)	0.2 W	0.36 W	0.8 W

### Dimensions

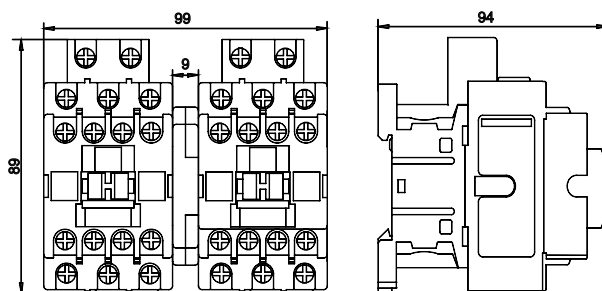

### Mounting positions

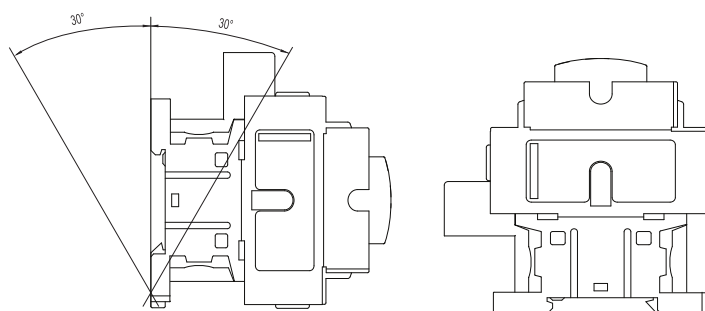

# Technical Data Ex9CR, frame size 18

## Reversible contactors Ex9CR09, Ex9CR12, Ex9CR18

### Wiring diagram

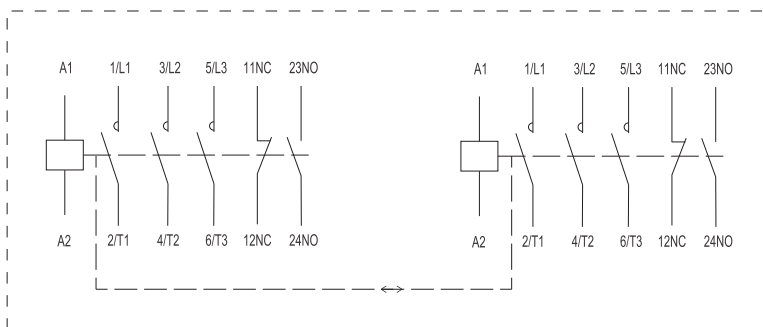

Ex9CR.. 11 3P

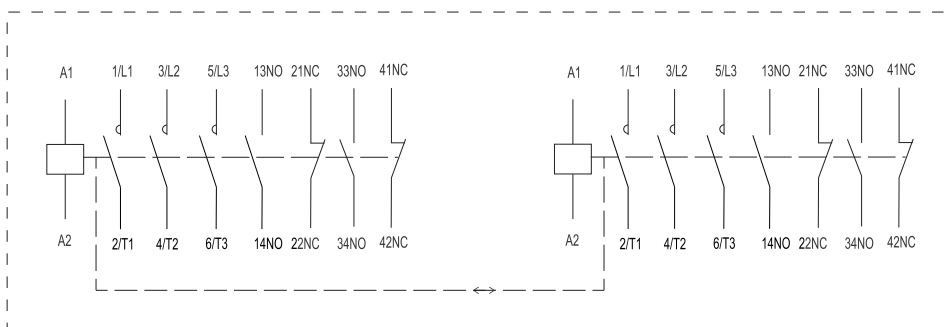

Ex9CR.. 22 3P

# Technical Data Ex9CR, frame size 38

## Reversible contactors Ex9CR25, Ex9CR32, Ex9CR38

### General parameters

Reversible combinations of contactors rated at AC-3

Suitable mainly for industrial applications

3-pole versions

Built-in mechanical interlock between particular contactors

With built-in auxiliary contacts

Accessories

Front-mounted auxiliary contacts	AX42	101284 — 101291
Side-mounted auxiliary contacts	AX4311	101292
Surge suppressor block	CCU42	104498, 104499, 104500

### Electrical parameters - main contacts and general

	Ex9CR25	Ex9CR32	Ex9CR38
Tested according to	IEC/EN 60947-4-1		
Rated op. voltage $U_e$	690 V AC		
Rated insulating voltage $U_i$	690 V AC		
Rated impulse withstand voltage $U_{imp}$	6 kV	6 kV	6 kV
Rated frequency	50/60 Hz		
Interlocked opposing contacts according to EN 60947-4-1, Annex L	yes	yes	yes
Conventional free air thermal current $I_{th}$	40 A	50 A	50 A
Rated operational current $I_e$			
AC-1	40 A	50 A	50 A
AC-2/AC-3/AC-4, 380/400 V	25 A	32 A	38 A
AC-3, 660/690 V	17.3 A	21.9 A	21.9 A
AC-2/AC-4, 660/690 V	14 A	17.3 A	17.3 A
Rated power of 3-phase motor			
AC-3/AC-4, 380/400 V	11 kW	15 kW	18.5 kW
AC-3, 660/690 V	15 kW	18.5 kW	18.5 kW
AC-4, 660/690 V	11 kW	15 kW	15 kW
Maximum short circuit protection fuse			
Coordination type 1 at 500 V AC	63 A gG/gL	63 A gG/gL	63 A gG/gL
Coordination type 2 at 500 V AC	40 A gG/gL	63 A gG/gL	63 A gG/gL
Safe isolation (EN 61140)			
Main contact — main contact	400 V AC	400 V AC	400 V AC
Main contact — coil	400 V AC	400 V AC	400 V AC
3-phase power AC-1			
Maximum back-up fuse gG/gL	80 A	100 A	100 A
Power at 230/240 V	16 kW	20 kW	20 kW
Power at 380/400 V	26 kW	33 kW	33 kW
Power at 660/690 V	46 kW	57 kW	57 kW
Rated current $I_e = I_{th}$	40 A	50 A	50 A
1-phase power AC-1, 3 contacts in parallel			
Maximum back-up fuse gG/gL	160 A	160 A	160 A
Power at 230/240 V	34 kW	42 kW	42 kW
Power at 380/400 V	55 kW	69 kW	69 kW
Power at 660/690 V	96 kW	120 kW	120 kW
Rated current $I_e = I_{th}$	84 A	105 A	105 A

# Technical Data Ex9CR, frame size 38

## Reversible contactors Ex9CR25, Ex9CR32, Ex9CR38

### Electrical parameters - main contacts and general

	Ex9CR25	Ex9CR32	Ex9CR38
Making capacity			
230/240 V	300 A	384 A	456 A
380/400 V	300 A	384 A	456 A
660/690 V	300 A	384 A	456 A
Breaking capacity			
230/240 V	250 A	320 A	320 A
380/400 V	250 A	320 A	320 A
660/690 V	173 A	219 A	219 A
Mechanical service life	10 000 000 operation cycles		
Electrical service life 380/400 V			
AC-3	1 200 000 operation cycles		
AC-4	50 000 operation cycles	40 000 operation cycles	40 000 operation cycles
Overvoltage category	III		
EMC environment	A		
Comparative Tracking Index	400 V		
Prospective short circuit current $I_q$	50 kA		

### Electrical parameters - coil

	Ex9CR25	Ex9CR32	Ex9CR38
Control Voltage $U_c$	24, 36, 42, 48, 110, 127, 220, 230, 240, 380, 400, 415 V AC		
Tolerance of Control Voltage $U_c$	0.8 — 1.1 $U_c$	0.8 — 1.1 $U_c$	0.8 — 1.1 $U_c$
Frequency	50 Hz	50 Hz	50 Hz
Power consumption			
Pick-up	100 VA / 50 W	100 VA / 50 W	100 VA / 50 W
Hold	10.5 VA / 5 W	10.5 VA / 5 W	10.5 VA / 5 W
Duty	100 %	100 %	100 %
Closing delay	14 — 27 ms	14 — 27 ms	14 — 27 ms
Opening delay	7 — 22 ms	7 — 22 ms	7 — 22 ms
Closing delay with front-mounted AX	9 — 20 ms	9 — 20 ms	9 — 20 ms

### Electrical parameters - built-in auxiliary contacts

Rated op. voltage $U_e$	690 V AC
Rated insulating voltage $U_i$	690 V AC
Rated impulse withstand voltage $U_{imp}$	6 kV
Rated frequency	50 Hz
Interlocked opposing contacts according to EN 60947-4-1, Annex L	yes
Conventional free air thermal current $I_{th}$	10 A
Rated operational current $I_e$	
AC-15	6 A / 120 V, 3 A / 240 V, 1.9 A / 380 V, 1.5 A / 480 V, 1.2 A / 600 V
DC-13	0.55 A / 125 V, 0.27 A / 250 V
Max. back-up fuse	10 A gG/gL
Conditional short circuit current $I_k$ with max. back-up fuse	1 kA

# Technical Data Ex9CR, frame size 38

## Reversible contactors Ex9CR25, Ex9CR32, Ex9CR38

### Mechanical parameters

	Ex9CR25	Ex9CR32	Ex9CR38
Device width	99 mm		
Device height	100 mm (including rail clip)		
Device depth	108 mm (without front-mounted auxiliary contact)		
Mounting	easy fastening onto 35 mm device rail (DIN) or onto panel		
Degree of protection	IP20		
Terminals	lift		
Terminal capacity	(1 — 2) x (2.5 — 10 mm <sup>2</sup> ) wired; 1 x (1 — 10 mm <sup>2</sup> ), 2 x (1.5 — 6 mm <sup>2</sup> ) solid		
Fastening torque of terminals	2 — 2.5 Nm		
Ambient temperature	-20 — +60 °C		
Altitude	≤ 2000 m		
Relative humidity	≤ 95 %		
Resistance to humidity and heat	class 2		
Pollution degree	3		
Installation class	III		
Weight	0.82 kg	0.82 kg	0.82 kg
Power loss at $I_e$ (per contactor)	1.25 W	2 W	3 W

### Dimensions

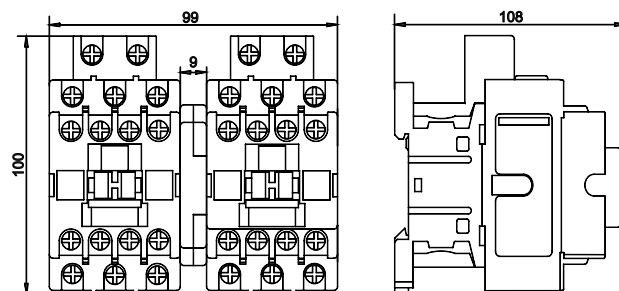

### Mounting positions

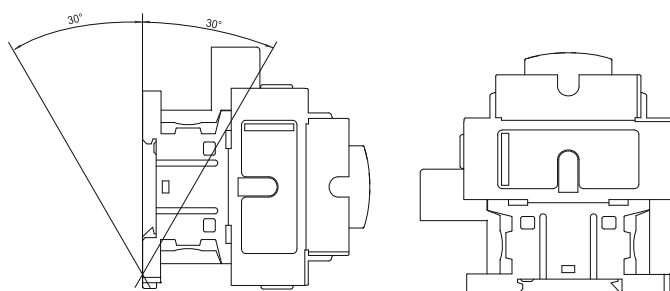

# Technical Data Ex9CR, frame size 38

## Reversible contactors Ex9CR25, Ex9CR32, Ex9CR38

### Wiring diagram

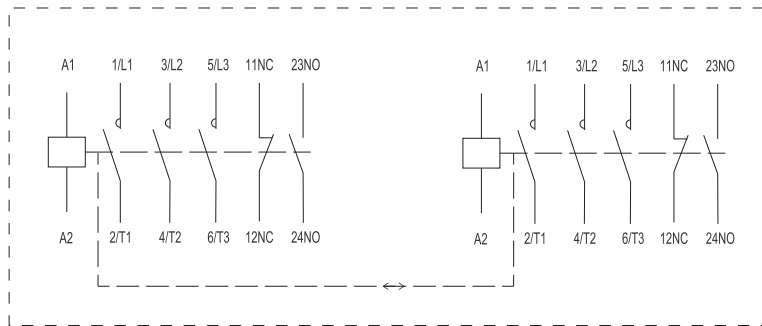

Ex9CR.. 11 3P

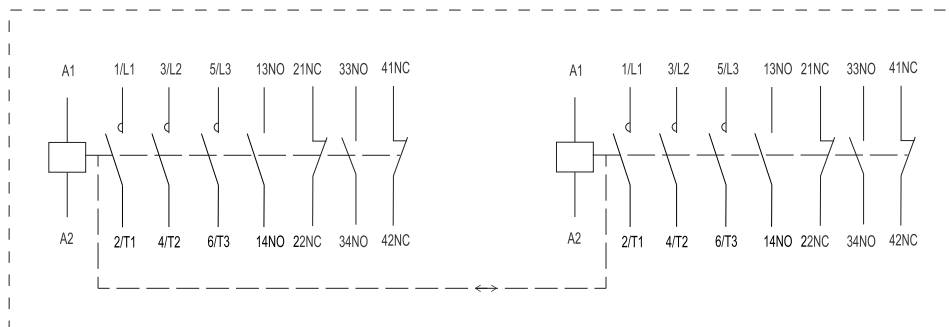

Ex9CR.. 22 3P

# Technical Data Ex9CR, frame size 65

## Reversible contactors Ex9CR40, Ex9CR50, Ex9CR65

### General parameters

Reversible combinations of contactors		
Contactors rated at AC-3		
Suitable mainly for industrial applications		
3-pole versions		
Built-in mechanical interlock between particular contactors		
With built-in auxiliary contacts		
Accessories		
Front-mounted auxiliary contacts	AX42	101284 — 101291
Side-mounted auxiliary contacts	AX4311	101292
Surge suppressor block	CCU43	104495, 104496, 104497

### Electrical parameters - main contacts and general

	Ex9CR40	Ex9CR50	Ex9CR65
Tested according to	IEC/EN 60947-4-1		
Rated op. voltage $U_e$	690 V AC		
Rated insulating voltage $U_i$	1000 V AC		
Rated impulse withstand voltage $U_{imp}$	6 kV	6 kV	6 kV
Rated frequency	50/60 Hz		
Interlocked opposing contacts according to EN 60947-4-1, Annex L	yes	yes	yes
Conventional free air thermal current $I_{th}$	60 A	80 A	80 A
Rated operational current $I_e$			
AC-1	60 A	80 A	80 A
AC-2/AC-3/AC-4, 380/400 V	40 A	50 A	65 A
AC-2/AC-3/AC-4, 660/690 V	34 A	39 A	42 A
Rated power of 3-phase motor			
AC-3/AC-4, 380/400 V	18.5 kW	22 kW	30 kW
AC-3/AC-4, 660/690 V	30 kW	33 kW	37 kW
Maximum short circuit protection fuse			
Coordination type 1 at 500 V AC	80 A gG/gL	100 A gG/gL	160 A gG/gL
Coordination type 2 at 500 V AC	80 A gG/gL	100 A gG/gL	125 A gG/gL
Safe isolation (EN 61140)			
Main contact — main contact	690 V AC	690 V AC	690 V AC
Main contact — coil	690 V AC	690 V AC	690 V AC
3-phase power AC-1			
Maximum back-up fuse gG/gL	125 A	160 A	160 A
Power at 230/240 V	24 kW	32 kW	32 kW
Power at 380/400 V	40 kW	53 kW	53 kW
Power at 660/690 V	69 kW	92 kW	92 kW
Rated current $I_e = I_{th}$	60 A	80 A	80 A
1-phase power AC-1, 3 contacts in parallel			
Maximum back-up fuse gG/gL	200 A	250 A	250 A
Power at 230/240 V	50 kW	67 kW	67 kW
Power at 380/400 V	83 kW	110 kW	110 kW
Power at 660/690 V	144 kW	192 kW	192 kW
Rated current $I_e = I_{th}$	126 A	168 A	168 A



# Technical Data Ex9CR, frame size 65

## Reversible contactors Ex9CR40, Ex9CR50, Ex9CR65

### Electrical parameters - main contacts and general

	Ex9CR40	Ex9CR50	Ex9CR65
Making capacity			
230/240 V	480 A	600 A	780 A
380/400 V	480 A	600 A	780 A
660/690 V	480 A	600 A	780 A
Breaking capacity			
230/240 V	400 A	500 A	650 A
380/400 V	400 A	500 A	650 A
660/690 V	340 A	390 A	420 A
Mechanical service life	10 000 000 operation cycles		
Electrical service life 380/400 V			
AC-3	1 200 000 operation cycles		
AC-4	35 000 operation cycles	30 000 operation cycles	30 000 operation cycles
Overvoltage category	III		
EMC environment	A		
Comparative Tracking Index	400 V		
Prospective short circuit current $I_q$	50 kA		

### Electrical parameters - coil

	Ex9CR40	Ex9CR50	Ex9CR65
Control Voltage $U_c$	24, 36, 42, 48, 110, 127, 220, 230, 240, 380, 400, 415 V AC		
Tolerance of Control Voltage $U_c$	0.8 — 1.1 $U_c$	0.8 — 1.1 $U_c$	0.8 — 1.1 $U_c$
Frequency	50 Hz	50 Hz	50 Hz
Power consumption			
Pick-up	240 VA / 100 W	240 VA / 100 W	240 VA / 100 W
Hold	25 VA / 10 W	25 VA / 10 W	25 VA / 10 W
Duty	100 %	100 %	100 %
Closing delay	20 — 30 ms	20 — 30 ms	20 — 30 ms
Opening delay	8 — 20 ms	8 — 20 ms	8 — 20 ms
Closing delay with front-mounted AX	12 — 25 ms	12 — 25 ms	12 — 25 ms

### Electrical parameters - built-in auxiliary contacts

Rated op. voltage $U_e$	690 V AC
Rated insulating voltage $U_i$	690 V AC
Rated impulse withstand voltage $U_{imp}$	6 kV
Rated frequency	50 Hz
Interlocked opposing contacts according to EN 60947-4-1, Annex L	yes
Conventional free air thermal current $I_{th}$	10 A
Rated operational current $I_e$	
AC-15	6 A / 120 V, 3 A / 240 V, 1.9 A / 380 V, 1.5 A / 480 V, 1.2 A / 600 V
DC-13	0.55 A / 125 V, 0.27 A / 250 V
Max. back-up fuse	10 A gG/gL
Conditional short circuit current $I_k$ with max. back-up fuse	1 kA

# Technical Data Ex9CR, frame size 65

## Reversible contactors Ex9CR40, Ex9CR50, Ex9CR65

### Mechanical parameters

	Ex9CR40	Ex9CR50	Ex9CR65
Device width	161 mm		
Device height	122 mm (including rail clip)		
Device depth	123 mm (without front-mounted auxiliary contact)		
Mounting	easy fastening onto 35 or 75 mm device rail (DIN) or onto panel		
Degree of protection	IP20		
Terminals	lift		
Terminal capacity	(1 — 2) x (2.5 — 25 mm <sup>2</sup> )		
Fastening torque of terminals	5.5 — 6 Nm		
Ambient temperature	-20 — +60 °C		
Altitude	≤ 2000 m		
Relative humidity	≤ 95 %		
Resistance to humidity and heat	class 2		
Pollution degree	3		
Installation class	III		
Weight	2.5 kg	2.5 kg	2.5 kg
Power loss at $I_e$ (per contactor)	2.4 W	3.7 W	4.2 W

### Dimensions

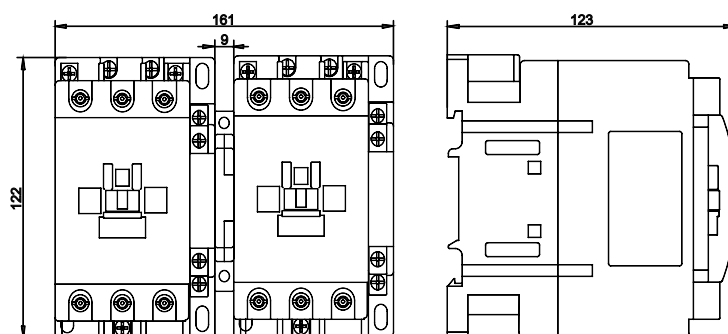

### Mounting positions

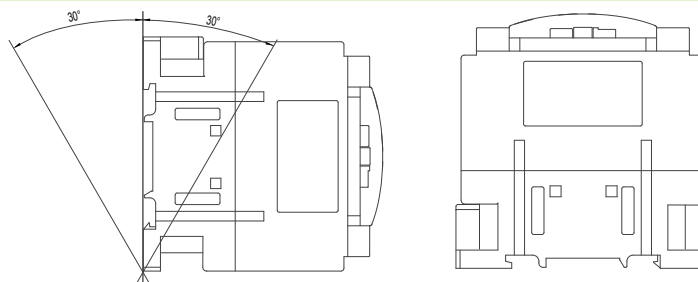

# Technical Data Ex9CR, frame size 65

## Reversible contactors Ex9CR40, Ex9CR50, Ex9CR65

### Wiring diagram

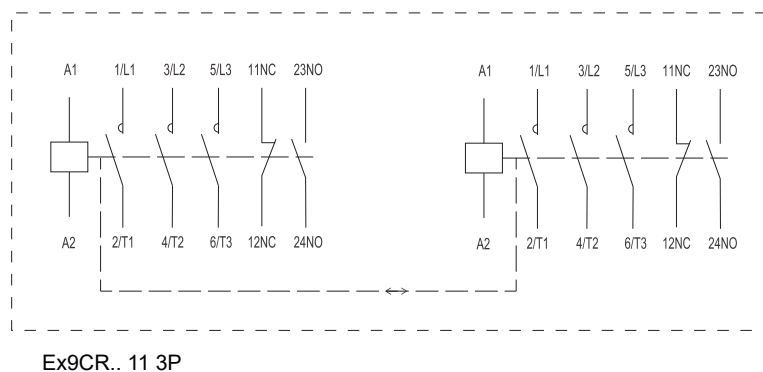

# Technical Data Ex9CR, frame size 100

## Reversible contactors Ex9CR80, Ex9CR100

### General parameters

Reversible combinations of contactors		
Contactors rated at AC-3		
Suitable mainly for industrial applications		
3-pole versions		
Built-in mechanical interlock between particular contactors		
With built-in auxiliary contacts		
Accessories		
Front-mounted auxiliary contacts	AX42	101284 — 101291
Side-mounted auxiliary contacts	AX4311	101292
Surge suppressor block	CCU43	104495, 104496, 104497

### Electrical parameters - main contacts and general

	Ex9CR80	Ex9CR100
Tested according to	IEC/EN 60947-4-1	
Rated op. voltage $U_e$	690 V AC	
Rated insulating voltage $U_i$	1000 V AC	
Rated impulse withstand voltage $U_{imp}$	6 kV	6 kV
Rated frequency	50/60 Hz	
Interlocked opposing contacts according to EN 60947-4-1, Annex L	yes	yes
Conventional free air thermal current $I_{th}$	125 A	125 A
Rated operational current $I_e$		
AC-1	125 A	125 A
AC-2/AC-3/AC-4, 380/400 V	80 A	100 A
AC-2/AC-3/AC-4, 660/690 V	49 A	49 A
Rated power of 3-phase motor		
AC-3/AC-4, 380/400 V	37 kW	45 kW
AC-3/AC-4, 660/690 V	45 kW	45 kW
Maximum short circuit protection fuse		
Coordination type 1 at 500 V AC	200 A gG/gL	200 A gG/gL
Coordination type 2 at 500 V AC	160 A gG/gL	160 A gG/gL
Safe isolation (EN 61140)		
Main contact — main contact	690 V AC	690 V AC
Main contact — coil	690 V AC	690 V AC
3-phase power AC-1		
Maximum back-up fuse gG/gL	250 A	250 A
Power at 230/240 V	50 kW	50 kW
Power at 380/400 V	82 kW	82 kW
Power at 660/690 V	143 kW	143 kW
Rated current $I_e = I_{th}$	125 A	125 A
1-phase power AC-1, 3 contacts in parallel		
Maximum back-up fuse gG/gL	400 A	400 A
Power at 230/240 V	105 kW	105 kW
Power at 380/400 V	172 kW	172 kW
Power at 660/690 V	300 kW	300 kW
Rated current $I_e = I_{th}$	262 A	262 A

# Technical Data Ex9CR, frame size 100

## Reversible contactors Ex9CR80, Ex9CR100

### Electrical parameters - main contacts and general

	Ex9CR80	Ex9CR100
Making capacity		
230/240 V	960 A	1200 A
380/400 V	960 A	1200 A
660/690 V	960 A	1200 A
Breaking capacity		
230/240 V	800 A	1000 A
380/400 V	800 A	1000 A
660/690 V	490 A	490 A
Mechanical service life	10 000 000 operation cycles	
Electrical service life 380/400 V		
AC-3	1 200 000 operation cycles	
AC-4	25 000 operation cycles	25 000 operation cycles
Overvoltage category	III	
EMC environment	A	
Comparative Tracking Index	400 V	
Prospective short circuit current $I_q$	50 kA	

### Electrical parameters - coil

	Ex9CR80	Ex9CR100
Control Voltage $U_c$	24, 36, 42, 48, 110, 127, 220, 230, 240, 380, 400, 415 V AC	
Tolerance of Control Voltage $U_c$	0.8 — 1.1 $U_c$	
Frequency	50 Hz	
Power consumption		
Pick-up	280 VA / 120 W	280 VA / 120 W
Hold	30 VA / 12 W	30 VA / 12 W
Duty	100 %	
Closing delay	20 — 35 ms	
Opening delay	6 — 20 ms	
Closing delay with front-mounted AX	12 — 30 ms	

### Electrical parameters - built-in auxiliary contacts

Rated op. voltage $U_e$	690 V AC
Rated insulating voltage $U_i$	690 V AC
Rated impulse withstand voltage $U_{imp}$	6 kV
Rated frequency	50 Hz
Interlocked opposing contacts according to EN 60947-4-1, Annex L	yes
Conventional free air thermal current $I_{th}$	10 A
Rated operational current $I_e$	
AC-15	6 A / 120 V, 3 A / 240 V, 1.9 A / 380 V, 1.5 A / 480 V, 1.2 A / 600 V
DC-13	0.55 A / 125 V, 0.27 A / 250 V
Max. back-up fuse	10 A gG/gL
Conditional short circuit current $I_k$ with max. back-up fuse	1 kA

# Technical Data Ex9CR, frame size 100

## Reversible contactors Ex9CR80, Ex9CR100

### Mechanical parameters

	Ex9CR80	Ex9CR100
Device width	183 mm	
Device height	130 mm (including rail clip)	
Device depth	130 mm (without front-mounted auxiliary contact)	
Mounting	easy fastening onto 35 or 75 mm device rail (DIN) or onto panel	
Degree of protection	IP20	
Terminals	lift	
Terminal capacity	(1 — 2) x (4 — 50 mm <sup>2</sup> )	
Fastening torque of terminals	5.5 — 6 Nm	
Ambient temperature	-20 — +60 °C	
Altitude	≤ 2000 m	
Relative humidity	≤ 95 %	
Resistance to humidity and heat	class 2	
Pollution degree	3	
Installation class	III	
Weight	3 kg	3 kg
Power loss at $I_e$ (per contactor)	5.1 W	7.5 W

### Dimensions

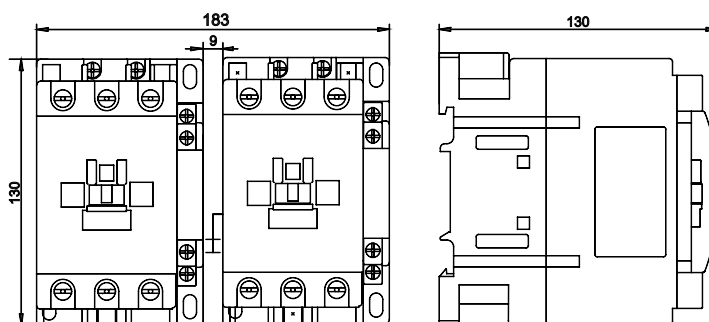

### Mounting positions

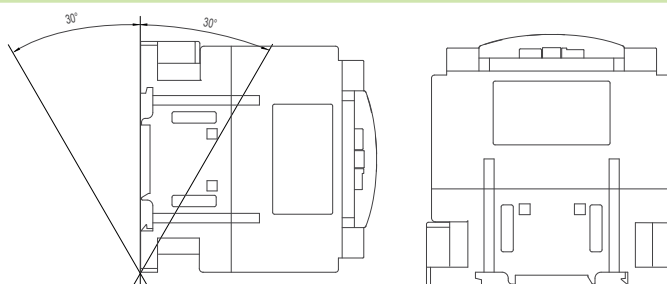

# Technical Data Ex9CR, frame size 100

## Reversible contactors Ex9CR80, Ex9CR100

### Wiring diagram

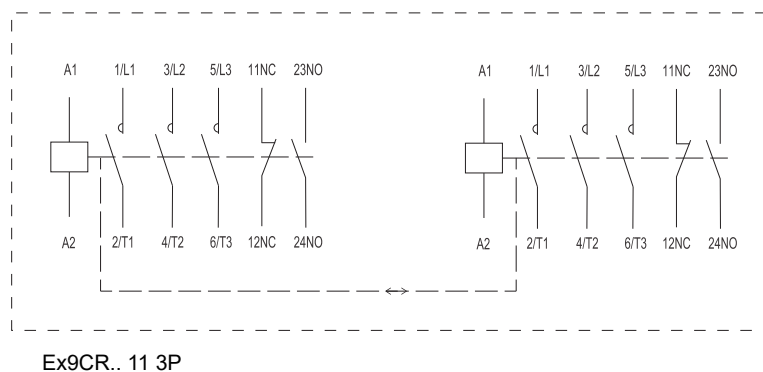

# Technical Data Ex9C, frame size 185

## Contactors Ex9C115, Ex9C150, Ex9C185

### General parameters

Contactors rated at AC-3		
Suitable for industrial applications		
3-pole versions		
Mounting with screws onto panel		
With built-in 2NO + 2NC auxiliary contacts		
Accessories		
Front-mounted auxiliary contacts	AX42	101284 — 101291
Side-mounted auxiliary contacts	AX44	106322, 107958, 107957
Overload thermal relay	Ex9R185	106326 — 106328
Pneumatic time delay block	TDD4	104489 — 104494
Mechanical interlocks	MIT44	107962
Reversible connection sets	PCL185	107965

### Electrical parameters - main contacts and general

	Ex9C115	Ex9C150	Ex9C185
Tested according to	IEC/EN 60947-4-1		
Rated operating voltage $U_e$	230 / 400 / 690 / 1000 V AC		
Rated insulating voltage $U_i$	1000 V AC		
Rated impulse withstand voltage $U_{imp}$	8 kV		
Rated frequency for AC	50/60 Hz		
Interlocked opposing contacts according to EN 60947-4-1, Annex L	yes	yes	yes
Conventional free air thermal current $I_{th}$	160 A	185 A	215 A
Rated operational current $I_e$			
AC-1	160 A	185 A	215 A
AC-3 / AC-4 at 400 V	115 A / 54 A	150 A / 68 A	185 A / 81 A
AC-3 / AC-4 at 690 V	115 A / 48 A	150 A / 57 A	170 A / 65 A
AC-3 / AC-4 at 1000 V	53 A / 34 A	65 A / 38 A	65 A / 42 A
Rated power of 3-phase motor			
AC-3 / AC-4 at 230 V	37 kW / 18.5 kW	45 kW / 22 kW	55 kW / 30 kW
AC-3 / AC-4 at 400 V	55 kW / 30 kW	75 kW / 37 kW	90 kW / 45 kW
AC-3 / AC-4 at 690 V	110 kW / 50 kW	132 kW / 55 kW	160 kW / 63 kW
Maximum short circuit protection fuse			
Coordination type 1 at 500 V AC	355 A gG/gL	355 A gG/gL	355 A gG/gL
Coordination type 2 at 500 V AC	315 A gG/gL	315 A gG/gL	315 A gG/gL
Safe isolation (EN 61140)			
Main contact — main contact	600 V AC	600 V AC	600 V AC
Main contact — coil	600 V AC	600 V AC	600 V AC
3-phase power AC-1			
Maximum back-up fuse gG/gL	400 A	400 A	400 A
Rated current $I_e = I_{th}$	160 A	185 A	215 A



# Technical Data Ex9C, frame size 185

## Contactors Ex9C115, Ex9C150, Ex9C185

### Electrical parameters - main contacts and general

	Ex9C115	Ex9C150	Ex9C185
Making capacity			
AC-3 / AC-4 at 230 V	1150 A / 648 A	1500 A / 816 A	1850 A / 972 A
AC-3 / AC-4 at 400 V	1150 A / 648 A	1500 A / 816 A	1850 A / 972 A
AC-3 / AC-4 at 690 V	1150 A / 576 A	1500 A / 684 A	1700 A / 780 A
Breaking capacity			
AC-3 / AC-4 at 230 V	920 A / 540 A	1200 A / 680 A	1480 A / 810 A
AC-3 / AC-4 at 400 V	920 A / 540 A	1200 A / 680 A	1480 A / 810 A
AC-3 / AC-4 at 690 V	920 A / 480 A	1200 A / 570 A	1360 A / 650 A
Mechanical service life	8 000 000 operation cycles		
Electrical service life 380/400 V			
AC-3	1 000 000 operation cycles		
AC-4	200 000 operation cycles		
Switching frequency			
AC-3	1 000 oper. cycles per hour	750 oper. cycles per hour	750 oper. cycles per hour
AC-4	130 oper. cycles per hour	130 oper. cycles per hour	130 oper. cycles per hour
Overvoltage category	III		
Comparative Tracking Index	400 V		
Prospective short circuit current $I_q$	50 kA		

### Electrical parameters - control coil

	Ex9C115	Ex9C150	Ex9C185
Control Voltage $U_c$	24, 36, 42, 48, 110, 127, 220, 230, 240, 380, 400, 415 V AC/DC		
Tolerance of Control Voltage $U_c$	0.85 — 1.1 $U_c$		
Frequency	50 Hz / DC		
Power consumption AC / DC			
Pick-up	400 VA / 400 W		
Hold	10 VA / 10 W		
Duty	100 %		
Closing delay	30 — 65 ms		
Opening delay	45 — 65 ms		

### Electrical parameters - built-in auxiliary contacts

Built-in auxiliary contacts	2 NO + 2 NC		
Rated operating voltage $U_e$	690 V AC		
Rated insulating voltage $U_i$	690 V AC		
Rated impulse withstand voltage $U_{imp}$	6 kV		
Rated frequency	50 Hz		
Interlocked opposing contacts according to EN 60947-4-1, Annex L	yes		
Conventional free air thermal current $I_{th}$	10 A		
Rated operational current $I_e$			
AC-15	6 A at 24 V, 3.13 A at 230 V, 1.8 A at 400 V, 1.04 A at 690 V		
DC-13	0.55 A at 125 V, 0.27 A at 250 V		
Max. back-up fuse	10 A gG/gL		
Conditional short circuit current $I_k$ with max. back-up fuse	1 kA		

# Technical Data Ex9C, frame size 185

## Contactors Ex9C115, Ex9C150, Ex9C185

### Mechanical parameters

	Ex9C115	Ex9C150	Ex9C185
Device width		120 mm	
Device height		173 mm	
Device depth		174 mm	
Mounting	with screws onto panel		
Degree of protection	IP20		
Terminals	connection plates for M8 screw		
Terminal capacity	copper bar 2x20x5 or 2x cable lug 25 — 120 mm <sup>2</sup>		
Fastening torque of the screw	18 Nm		
Control coil terminal capacity	1 — 2.5 mm <sup>2</sup>		
Control coil terminal fastening torque	1.7 Nm		
Ambient temperature	-20 — +60 °C		
Altitude	≤ 2000 m		
Relative humidity	≤ 90 %		
Resistance to humidity and heat	class 2		
Pollution degree	3		
Installation class	III		
Weight	3 kg		

### Dimensions

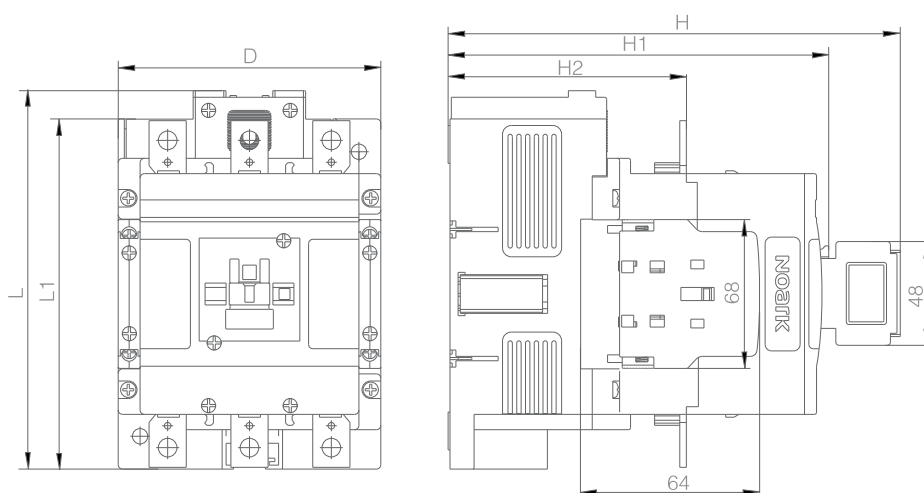

	Ex9C115	Ex9C150	Ex9C185
D		120 mm	
L		173 mm	
L1		160 mm	
H		205 mm	
H1		174 mm	
H2		108 mm	

# Technical Data Ex9C, frame size 185

Contactors Ex9C115, Ex9C150, Ex9C185

## Dimensions of reversible combination

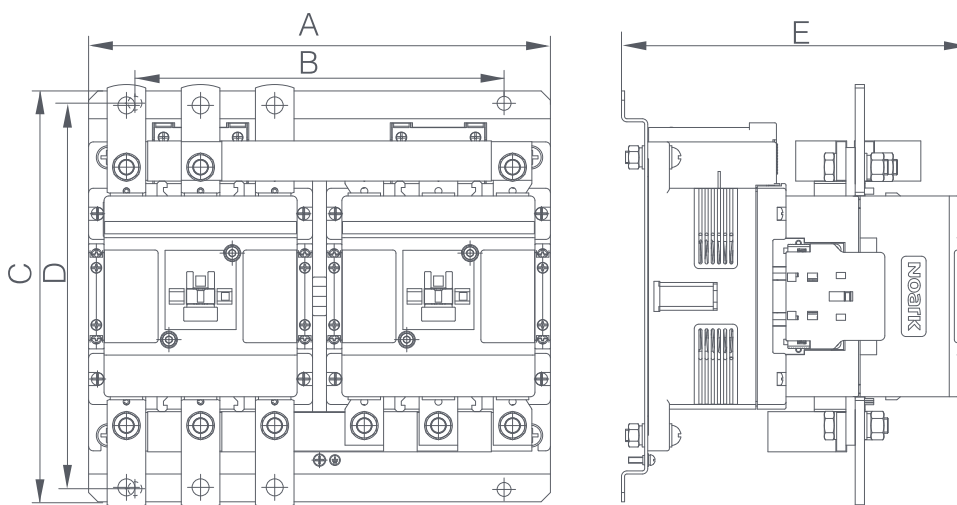

	Ex9C115	Ex9C150	Ex9C185
A		249 mm	
B		189 mm	
C		230 mm	
D		214 mm	
E		194 mm	

## Mounting positions

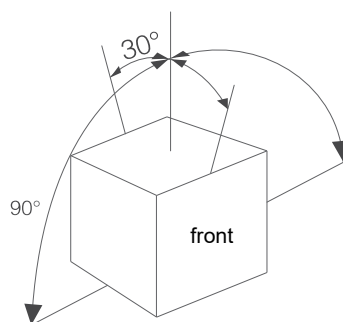

## Wiring diagram

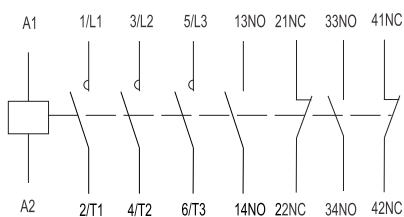

# Technical Data Ex9C, frame size 300

## Contactors Ex9C225, Ex9C265, Ex9C300

### General parameters

Contactors rated at AC-3

Suitable for industrial applications

3-pole versions

Mounting with screws onto panel

With built-in 2NO + 2NC auxiliary contacts

Accessories

Front-mounted auxiliary contacts	AX42	101284 — 101291
Side-mounted auxiliary contacts	AX44	106322, 107958, 107957
Overload thermal relay	Ex9R500	106329 — 106332
Pneumatic time delay block	TDD4	104489 — 104494
Mechanical interlocks	MIT45	107963
Reversible connection sets	PCL300	107966

### Electrical parameters - main contacts and general

	Ex9C225	Ex9C265	Ex9C300
Tested according to	IEC/EN 60947-4-1		
Rated operating voltage $U_e$	230 / 400 / 690 / 1000 V AC		
Rated insulating voltage $U_i$	1000 V AC		
Rated impulse withstand voltage $U_{imp}$	8 kV		
Rated frequency for AC	50/60 Hz		
Interlocked opposing contacts according to EN 60947-4-1, Annex L	yes	yes	yes
Conventional free air thermal current $I_{th}$	275 A	330 A	400 A
Rated operational current $I_e$			
AC-1	275 A	330 A	400 A
AC-3 / AC-4 at 400 V	225 A / 96 A	265 A / 117 A	300 A / 125 A
AC-3 / AC-4 at 690 V	225 A / 85 A	265 A / 105 A	280 A / 115 A
AC-3 / AC-4 at 1000 V	68 A / 42 A	95 A / 57 A	95 A / 57 A
Rated power of 3-phase motor			
AC-3 / AC-4 at 230 V	55 kW / 30 kW	75 kW / 37 kW	90 kW / 40 kW
AC-3 / AC-4 at 400 V	110 kW / 55 kW	132 kW / 63 kW	160 kW / 75 kW
AC-3 / AC-4 at 690 V	200 kW / 80 kW	250 kW / 100 kW	250 kW / 110 kW
Maximum short circuit protection fuse			
Coordination type 1 at 500 V AC	500 A gG/gL	500 A gG/gL	500 A gG/gL
Coordination type 2 at 500 V AC	400 A gG/gL	400 A gG/gL	400 A gG/gL
Safe isolation (EN 61140)			
Main contact — main contact	600 V AC	600 V AC	600 V AC
Main contact — coil	600 V AC	600 V AC	600 V AC
3-phase power AC-1			
Maximum back-up fuse gG/gL	500 A	800 A	800 A
Rated current $I_e = I_{th}$	275 A	330 A	400 A

# Technical Data Ex9C, frame size 300

## Contactors Ex9C225, Ex9C265, Ex9C300

### Electrical parameters - main contacts and general

	Ex9C225	Ex9C265	Ex9C300
Making capacity			
AC-3 / AC-4 at 230 V	2250 A / 1152 A	2650 A / 1404 A	3000 A / 1500 A
AC-3 / AC-4 at 400 V	2250 A / 1152 A	2650 A / 1404 A	3000 A / 1500 A
AC-3 / AC-4 at 690 V	2250 A / 1020 A	2650 A / 1260 A	2800 A / 1380 A
Breaking capacity			
AC-3 / AC-4 at 230 V	1800 A / 960 A	2120 A / 1170 A	2400 A / 1250 A
AC-3 / AC-4 at 400 V	1800 A / 960 A	2120 A / 1170 A	2400 A / 1250 A
AC-3 / AC-4 at 690 V	1800 A / 850 A	2120 A / 1050 A	2240 A / 1150 A
Mechanical service life	8 000 000 operation cycles		
Electrical service life 380/400 V			
AC-3	1 000 000 operation cycles		
AC-4	200 000 operation cycles		
Switching frequency			
AC-3	500 oper. cycles per hour	500 oper. cycles per hour	500 oper. cycles per hour
AC-4	130 oper. cycles per hour	130 oper. cycles per hour	130 oper. cycles per hour
Overvoltage category	III		
Comparative Tracking Index	400 V		
Prospective short circuit current $I_q$	50 kA		

### Electrical parameters - control coil

	Ex9C225	Ex9C265	Ex9C300
Control Voltage $U_c$	24, 36, 42, 48, 110, 127, 220, 230, 240, 380, 400, 415 V AC/DC		
Tolerance of Control Voltage $U_c$	0.85 — 1.1 $U_c$		
Frequency	50 Hz / DC		
Power consumption AC / DC			
Pick-up	590 VA / 590 W		
Hold	10 VA / 10 W		
Duty	100 %		
Closing delay	45 — 80 ms		
Opening delay	50 — 70 ms		

### Electrical parameters - built-in auxiliary contacts

Built-in auxiliary contacts	2 NO + 2 NC		
Rated operating voltage $U_e$	690 V AC		
Rated insulating voltage $U_i$	690 V AC		
Rated impulse withstand voltage $U_{imp}$	6 kV		
Rated frequency	50 Hz		
Interlocked opposing contacts according to EN 60947-4-1, Annex L	yes		
Conventional free air thermal current $I_{th}$	10 A		
Rated operational current $I_e$			
AC-15	6 A at 24 V, 3.13 A at 230 V, 1.8 A at 400 V, 1.04 A at 690 V		
DC-13	0.55 A at 125 V, 0.27 A at 250 V		
Max. back-up fuse	10 A gG/gL		
Conditional short circuit current $I_k$ with max. back-up fuse	1 kA		

# Technical Data Ex9C, frame size 300

## Contactors Ex9C225, Ex9C265, Ex9C300

### Mechanical parameters

	Ex9C225	Ex9C265	Ex9C300
Device width		145 mm	
Device height		212 mm	
Device depth		207 mm	
Mounting	with screws onto panel		
Degree of protection	IP20		
Terminals	connection plates for M10 screw		
Terminal capacity	copper bar 2x30x5 or 2x cable lug 50 — 240 mm <sup>2</sup>		
Fastening torque of the screw	35 Nm		
Control coil terminal capacity	1 — 2.5 mm <sup>2</sup>		
Control coil terminal fastening torque	1.7 Nm		
Ambient temperature	-20 — +60 °C		
Altitude	≤ 2000 m		
Relative humidity	≤ 90 %		
Resistance to humidity and heat	class 2		
Pollution degree	3		
Installation class	III		
Weight	6 kg		

### Dimensions

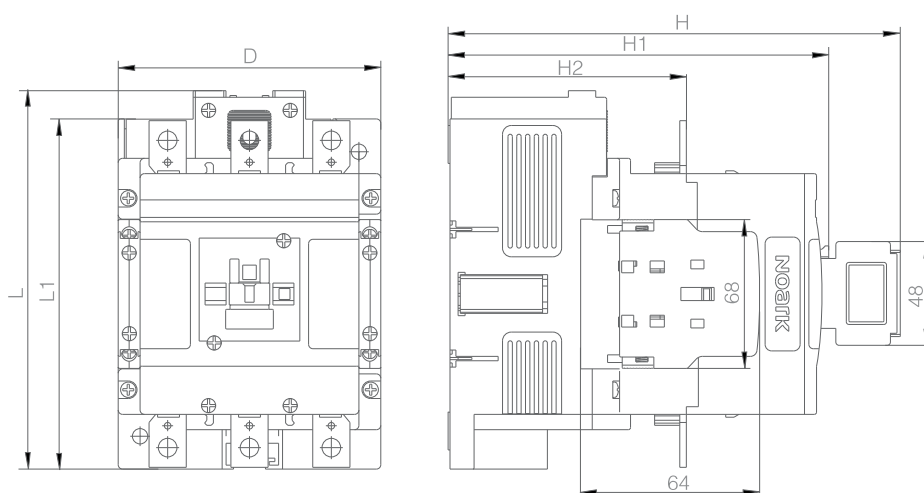

	Ex9C225	Ex9C265	Ex9C300
D		145 mm	
L		212 mm	
L1		200 mm	
H		239 mm	
H1		207 mm	
H2		134 mm	

# Technical Data Ex9C, frame size 300

Contactors Ex9C225, Ex9C265, Ex9C300

## Dimensions of reversible combination

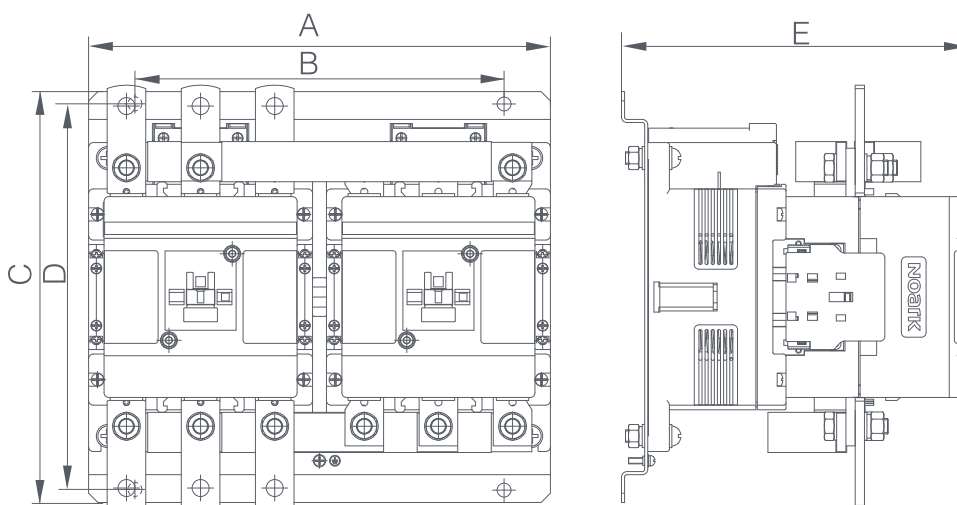

	Ex9C225	Ex9C265	Ex9C300
A		299 mm	
B		239 mm	
C		266 mm	
D		250 mm	
E		225 mm	

## Mounting positions

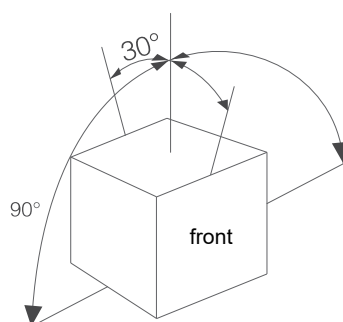

## Wiring diagram

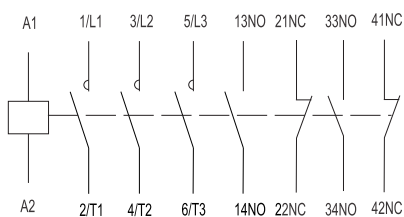

# Technical Data Ex9C, frame size 500

## Contactors Ex9C400, Ex9C500

### General parameters

Contactors rated at AC-3		
Suitable for industrial applications		
3-pole versions		
Mounting with screws onto panel		
With built-in 2NO + 2NC auxiliary contacts		
Accessories		
Front-mounted auxiliary contacts	AX42	101284 — 101291
Side-mounted auxiliary contacts	AX44	106322, 107958, 107957
Overload thermal relay	Ex9R500	106329 — 106332
Pneumatic time delay block	TDD4	104489 — 104494
Mechanical interlocks	MIT46	107964
Reversible connection sets	PCL500	107967

### Electrical parameters - main contacts and general

	Ex9C400	Ex9C500
Tested according to	IEC/EN 60947-4-1	
Rated operating voltage $U_e$	230 / 400 / 690 / 1000 V AC	
Rated insulating voltage $U_i$	1000 V AC	
Rated impulse withstand voltage $U_{imp}$	8 kV	
Rated frequency for AC	50/60 Hz	
Interlocked opposing contacts according to EN 60947-4-1, Annex L	yes	yes
Conventional free air thermal current $I_{th}$	430 A	610 A
Rated operational current $I_e$		
AC-1	430 A	610 A
AC-3 / AC-4 at 400 V	400 A / 150 A	500 A / 175 A
AC-3 / AC-4 at 690 V	400 A / 135 A	450 A / 150 A
AC-3 / AC-4 at 1000 V	180 A / 80 A	200 A / 80 A
Rated power of 3-phase motor		
AC-3 / AC-4 at 230 V	132 kW / 45 kW	160 kW / 55 kW
AC-3 / AC-4 at 400 V	220 kW / 90 kW	250 kW / 100 kW
AC-3 / AC-4 at 690 V	355 kW / 132 kW	400 kW / 150 kW
Maximum short circuit protection fuse		
Coordination type 1 at 500 V AC	630 A gG/gL	630 A gG/gL
Coordination type 2 at 500 V AC	630 A gG/gL	630 A gG/gL
Safe isolation (EN 61140)		
Main contact — main contact	600 V AC	600 V AC
Main contact — coil	600 V AC	600 V AC
3-phase power AC-1		
Maximum back-up fuse gG/gL	1000 A	1200 A
Rated current $I_e = I_{th}$	430 A	610 A



# Technical Data Ex9C, frame size 500

## Contactors Ex9C400, Ex9C500

### Electrical parameters - main contacts and general

	Ex9C400	Ex9C500
Making capacity		
AC-3 / AC-4 at 230 V	4000 A / 1800 A	5000 A / 2100 A
AC-3 / AC-4 at 400 V	4000 A / 1800 A	5000 A / 2100 A
AC-3 / AC-4 at 690 V	4000 A / 1620 A	4500 A / 1800 A
Breaking capacity		
AC-3 / AC-4 at 230 V	3200 A / 1500 A	4000 A / 1750 A
AC-3 / AC-4 at 400 V	3200 A / 1500 A	4000 A / 1750 A
AC-3 / AC-4 at 690 V	3200 A / 1350 A	3600 A / 1500 A
Mechanical service life	5 000 000 operation cycles	
Electrical service life 380/400 V		
AC-3	1 000 000 operation cycles	
AC-4	200 000 operation cycles	
Switching frequency		
AC-3	500 oper. cycles per hour	420 oper. cycles per hour
AC-4	130 oper. cycles per hour	130 oper. cycles per hour
Overvoltage category	III	
Comparative Tracking Index	400 V	
Prospective short circuit current $I_q$	50 kA	

### Electrical parameters - control coil

	Ex9C400	Ex9C500
Control Voltage $U_c$	36, 42, 48, 110, 127, 220, 230, 240, 380, 400, 415 V AC/DC	
Tolerance of Control Voltage $U_c$	0.85 — 1.1 $U_c$	
Frequency	50 Hz / DC	
Power consumption AC / DC		
Pick-up	600 VA / 600 W	
Hold	10 VA / 10 W	
Duty	100 %	
Closing delay	70 — 90 ms	
Opening delay	60 — 80 ms	

### Electrical parameters - built-in auxiliary contacts

Built-in auxiliary contacts	2 NO + 2 NC
Rated operating voltage $U_e$	690 V AC
Rated insulating voltage $U_i$	690 V AC
Rated impulse withstand voltage $U_{imp}$	6 kV
Rated frequency	50 Hz
Interlocked opposing contacts according to EN 60947-4-1, Annex L	yes
Conventional free air thermal current $I_{th}$	10 A
Rated operational current $I_e$	
AC-15	6 A at 24 V, 3.13 A at 230 V, 1.8 A at 400 V, 1.04 A at 690 V
DC-13	0.55 A at 125 V, 0.27 A at 250 V
Max. back-up fuse	10 A gG/gL
Conditional short circuit current $I_k$ with max. back-up fuse	1 kA

# Technical Data Ex9C, frame size 500

## Contactors Ex9C400, Ex9C500

### Mechanical parameters

	Ex9C400	Ex9C500
Device width	160 mm	
Device height	218 mm	
Device depth	229 mm	
Mounting	with screws onto panel	
Degree of protection	IP20	
Terminals	connection plates for M10 screw	
Terminal capacity	copper bar 2x30x5 or 2x cable lug 50 — 240 mm <sup>2</sup>	
Fastening torque of the screw	35 Nm	
Control coil terminal capacity	1 — 2.5 mm <sup>2</sup>	
Control coil terminal fastening torque	1.7 Nm	
Ambient temperature	-20 — +60 °C	
Altitude	≤ 2000 m	
Relative humidity	≤ 90 %	
Resistance to humidity and heat	class 2	
Pollution degree	3	
Installation class	III	
Weight	9,5 kg	

### Dimensions

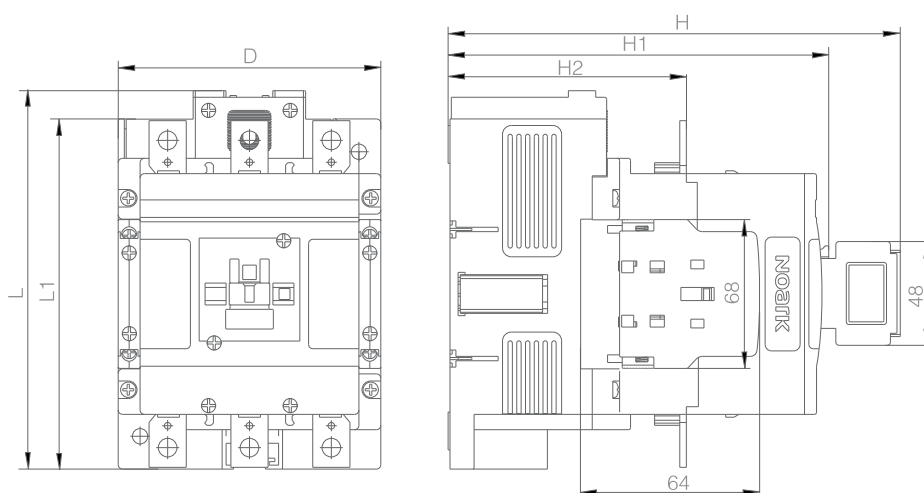

	Ex9C400	Ex9C500
D	160 mm	
L	218 mm	
L1	200 mm	
H	261 mm	
H1	229 mm	
H2	151 mm	

# Technical Data Ex9C, frame size 500

## Contactors Ex9C400, Ex9C500

### Dimensions of reversible combination

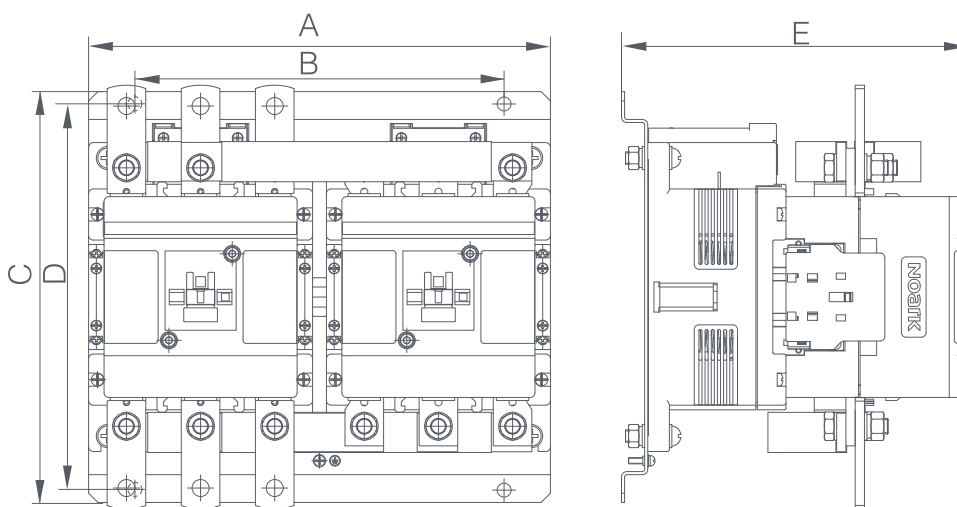

	Ex9C400	Ex9C500
A		329 mm
B		269 mm
C		268 mm
D		253 mm
E		246 mm

### Mounting positions

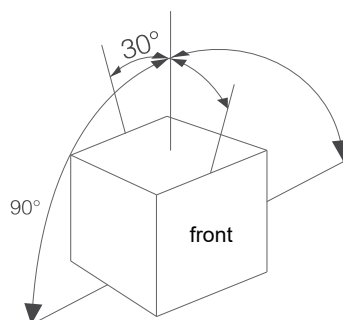

### Wiring diagram

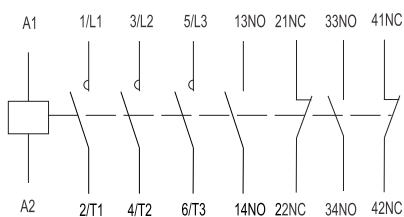

# Technical Data Ex9CC

## Capacitor contactors Ex9CC

### General parameters

Contactors rated at AC-6b		
Suitable for switching of power factor compensation		
3-pole versions		
Mounting onto device rail DIN (35 or 75 mm) or onto panel		
With various combinations of built-in auxiliary contacts		
Accessories		
Side-mounted auxiliary contacts	AX4311	101292
Surge suppressor blocks	CCU4	104495 - 104500

### Electrical parameters - main contacts and general

	Ex9CC25	Ex9CC38	Ex9CC50	Ex9CC65	Ex9CC80	Ex9CC100
Tested according to	IEC/EN 60947-4-1					
Rated operating voltage $U_e$	220-240 V AC, 380-415 V AC, 660-690 V AC					
Rated insulating voltage $U_i$	690 V AC					
Rated frequency	50/60 Hz					
Conventional free air thermal current $I_{th}$	50 A	50 A	80 A	80 A	125 A	125 A
Rated current AC-6b $I_e$						
AC-6b, 220-240 V	25 A	38 A	50 A	65 A	80 A	100 A
AC-6b, 380-415 V	25 A	38 A	50 A	65 A	80 A	100 A
AC-6b, 660-690 V	17.3 A	21.9 A	39 A	42 A	49 A	49 A
Rated operational power $Q_e$						
AC-6b, 220-240 V	8 kvar	15 kvar	20 kvar	25 kvar	30 kvar	40 kvar
AC-6b, 380-415 V	16 kvar	25 kvar	30 kvar	40 kvar	50 kvar	60 kvar
AC-6b, 660-690 V	25 kvar	40 kvar	50 kvar	60 kvar	80 kvar	90 kvar
Mechanical service life	1 000 000 operation cycles					
Electrical service life	200 000 operation cycles					
Operating frequency	180 operation cycles per hour		100 operation cycles per hour			
Max. permissible peak current I	30 x $I_e$					
Maximum short-circuit protection fuse Coordination type 1	63 A gG/gL	63 A gG/gL	100 A gG/gL	160 A gG/gL	200 A gG/gL	200 A gG/gL
Rated impulse withstand voltage $U_{imp}$	6 kV					
Safe isolation (EN 61140)						
Main contact	400 V AC		690 V AC		690 V AC	
Coil	400 V AC		690 V AC		690 V AC	
Overvoltage category	III					
EMC environment	A					
Comparative Tracking Index	400 A					
Prospective short circuit current $I_q$	50 kA					

# Technical Data Ex9CC

## Capacitor contactors Ex9CC

### Electrical parameters - coil

	Ex9CC25/38	Ex9CC50/65	Ex9CC80/100
Control Voltage $U_c$	24, 36, 42, 48, 110, 127, 220, 230, 240, 380, 400, 415 V AC		
Tolerance of Control Voltage $U_c$	0.85 - 1.15 x $U_c$		
Frequency	50/60 Hz		
Power consumption			
Pick-up	100 VA / 50 W	240 VA / 100 W	280 VA / 120 W
Hold	10.5 VA / 5W	25 VA / 10 W	30 VA / 12 W
Duty	100%		
Closing delay	14 - 27 ms	20 - 30 ms	20 - 35 ms
Opening delay	7 - 22 ms	8 - 20 ms	6 - 20 ms

### Electrical parameters - built-in auxiliary contacts

Rated operational voltage $U_e$	415 V AC
Rated frequency	50 Hz
Conventional free air thermal current $I_{th}$	10 A
Rated operational current $I_e$	
AC-15	6 A / 120 V, 3 A / 240 V, 1.9 A / 415 V, 1.2 A / 600 V
DC-13	0.55 A / 125 V, 0.31 A / 250 V
Making capacity	
AC-15	7200 VA
DC-13	69 W
Breaking capacity	
AC-15	720 VA
DC-13	69 W

### Mechanical parameters

	Ex9CC25/38	Ex9CC50/65	Ex9CC80/100
Device width	45 mm	76 mm	87 mm
Device height (including comp. block)	140 mm	190 mm	220 mm
Device depth (including comp. block)	136 mm	152 mm	158 mm
Mounting	easy fastening onto 35 mm (75 mm) device rail (DIN) or onto panel		
Degree of protection	IP20		
Terminals	lift		
Main contact terminal capacity	2.5 — 10 mm <sup>2</sup>	2.5 — 25 mm <sup>2</sup>	4 — 50 mm <sup>2</sup>
Fastening torque of main contact terminals	2.5 Nm	6 Nm	9 Nm
Auxiliary contact terminal capacity	2x 1.5 - 6 mm <sup>2</sup> (multi wire) 2x 1 - 4 mm <sup>2</sup> (fine wire)		
Fastening torque of auxiliary contact terminals	1.5 - 1.7 Nm		
Ambient temperature	-20 — +40 °C		
Altitude	≤ 2000 m		
Relative humidity	≤ 90 %		
Resistance to humidity and heat	class 2		
Pollution degree	3		
Installation class	III		
Weight	0.62 kg	1.65 kg	1.9 kg
Power loss at $I_e$	3 W	4.2 W	7.5 W

# Technical Data Ex9CC

## Capacitor contactors Ex9CC

### Dimensions

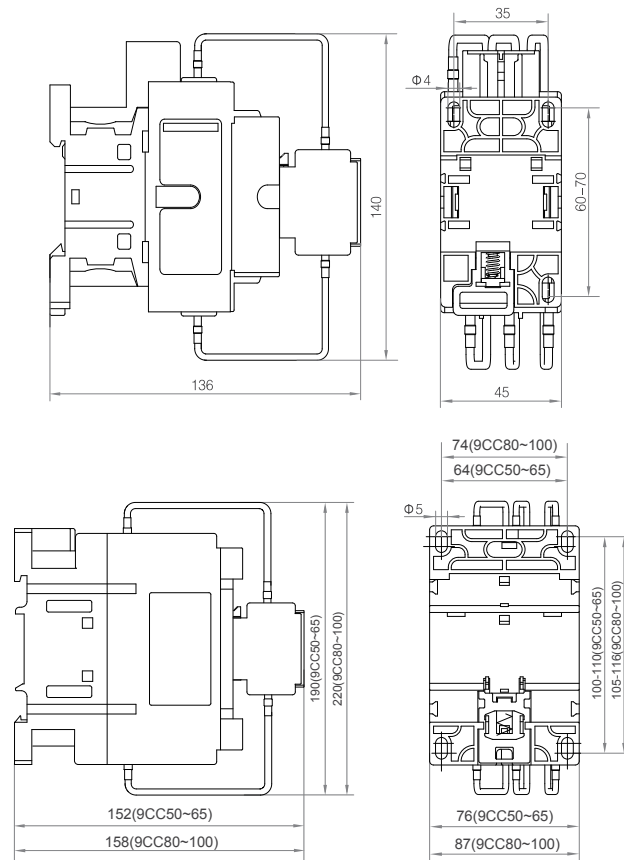

### Mounting position

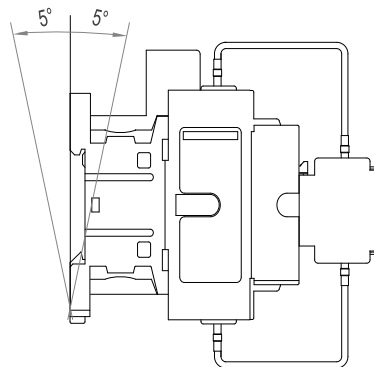

### Wiring diagram

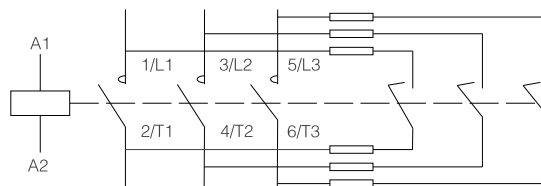

# Technical Data Ex9JP

## Monitoring control relays

### General functionalities

Indication lights help users to know the status of power grid
Low operating noise level
Temperature protection via PTC thermistor for usage on motor protective applications

### Electrical parameters

Tested according to	IEC / EN 60947-5-1
Rated operational voltage $U_e$	230/400 V AC
Rated operational frequency	50/60 Hz
Power consumption	< 3 W
Rated insulation voltage $U_i$	415 V
Rated impulse withstand voltage $U_{imp}$	4 kV
Contacts	1CO
Contact conventional heating current $I_{th}$	3 A
Rated contact current 240V AC	3 A, $\cos\phi = 1$ 0.75 A, $\cos\phi = 0.4$
Usage category	AC-15
Electrical service life	100 000 operating cycles
PTC fault detection resistance value	$\geq 1.5 \text{ k}\Omega$
PTC fault reset resistance value	$\leq 500 \Omega$
Electrostatic discharge immunity	8 kV $\pm 10\%$ (air discharge)
Radiated electromagnetic field immunity	Test electric field strength: 10 V/m $\pm 10\%$
Fast transient immunity	For power line: 2 kV $\pm 10\%$
Surge (impact) immunity	Open circuit test voltage: 1 kV $\pm 10\%$ (wire to wire)

### Mechanical parameters

Device width	36 mm (2MU)
Device height	91 mm
Device depth	66.2 mm
Mounting	easy fastening onto 35 mm device rail (DIN)
Degree of protection	IP20
Terminals	M2.5 screws
Terminal capacity	0.5 — 1 mm <sup>2</sup>
Fastening torque of terminals	0.5 Nm
Mechanical service life	1 000 000 operating cycles
Pollution degree	3
Installation class	II
Weight	0.181 kg
Operating ambient temperature	-5 — +40° C
Storage ambient temperature	-25 — +55° C

NOTE: Detailed function information of each type of Ex9JP can be found on selection pages 2 and 3

# Technical Data Ex9JP

## Monitoring control relays

### Dimensions

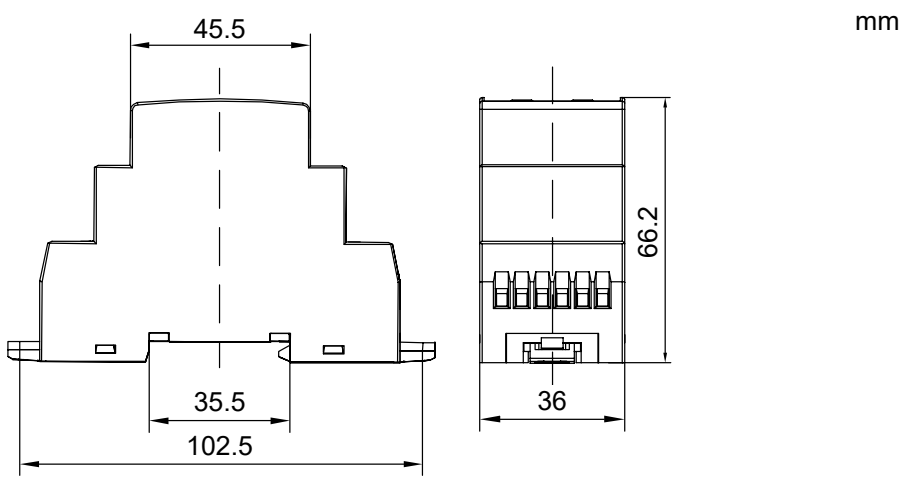

### Connections

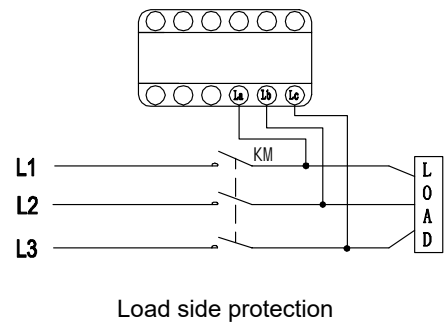
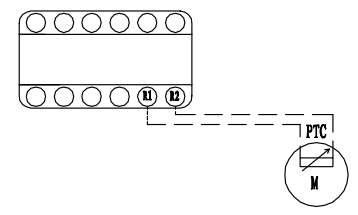
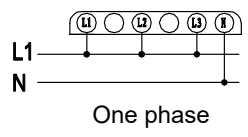
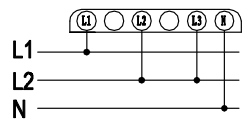
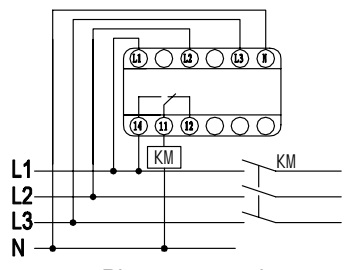
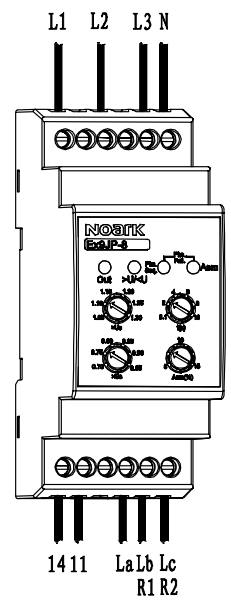



# Technical Data Ex9JP

## Monitoring control relays

### Wiring diagrams

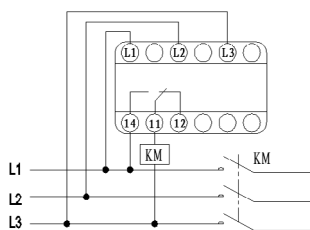

Ex9JP-1  
Ex9JP-2  
Ex9JP-3  
Ex9JP-4  
Ex9JP-5  
Ex9JP-6  
Ex9JP-7  
Ex9JP-8

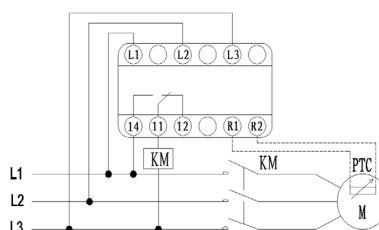

Ex9JP-1P  
Ex9JP-6P  
Ex9JP-7P  
Ex9JP-8P  
Ex9JP-17P

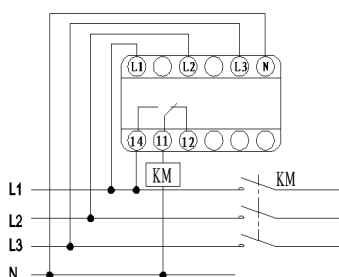

Ex9JP-12  
Ex9JP-13  
Ex9JP-14  
Ex9JP-15  
Ex9JP-16

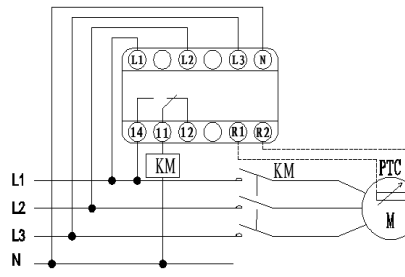

Ex9JP-13P  
Ex9JP-14P  
Ex9JP-15P  
Ex9JP-16P

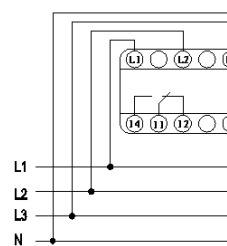

Ex9JP-9  
Ex9JP-10  
Ex9JP-11

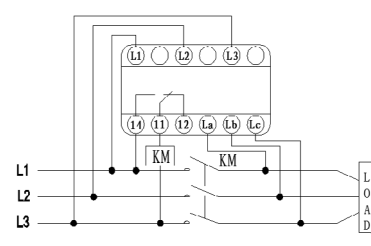

Ex9JP-18

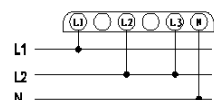

Two phase

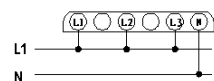

One phase

# Technical Data Ex9JM

## Plug-in relays Ex9JM

### General parameters

Plug and base offered separately
Locking button on a plug
Status indicator

### Electrical parameters

	Ex9JM2L10	Ex9JM2L05	Ex9JM4L03
Tested according to	IEC/EN 61810-1		
Control coil voltage $U_c$			
AC	24, 36, 48, 110, 230 V AC		
DC	12, 24, 36, 48, 110, 220 V DC		
Maximal coil voltage $U_{cmax}$	110% $U_c$		
Pick-up voltage (AC / DC)	$\leq 80\%$ / $\leq 75\%$ $U_c$		
Drop-off voltage (AC / DC)	$\geq 20\%$ / $\geq 10\%$ $U_c$		
Maximal switching voltage $U_e$	250 V AC / 30 V DC		
Switching time	$\leq 25$ ms		
Rated insulation voltage $U_i$			
main contacts	500 V AC		
coil to main contacts	1500 V AC		
Rated current AC-1	10 A	5 A	3 A
Controlled power AC-1	2500 VA / 300 W	1250 VA / 150 W	750 VA / 90 W
Electrical service life	100 000 operating cycles		
Initial contact resistance	100 m $\Omega$		
Coil power consumption	1.8 VA / 0.9 W		

### Mechanical parameters PLUG

	Ex9JM2L10	Ex9JM2L05	Ex9JM4L03
Device width	21.5 mm		
Device length	27.5 mm		
Device height	37 mm		
Contact material	Ag alloy		
Mechanical service life	10 000 000 operating cycles		
Ambient temperature	-25 — +55°C		
Pollution degree	2		
Weight	0.033 kg		

### Mechanical parameters BASES

	Ex9JM2DZ-10	Ex9JM2DZ-05	Ex9JM4DZ-03
Device width	29 mm	23 mm	30 mm
Device length	79 mm	72 mm	72 mm
Device height	33 mm	31 mm	31 mm
Terminals	M3 screws		
Mounting	easy fastening onto 35 mm device rail (DIN) or onto panel		
Mounting position	any		
Installation class	II		
Weight	0.050 kg	0.035 kg	0.049 kg

# Technical Data Ex9JM

## Plug-in relays Ex9JM

### Dimensions

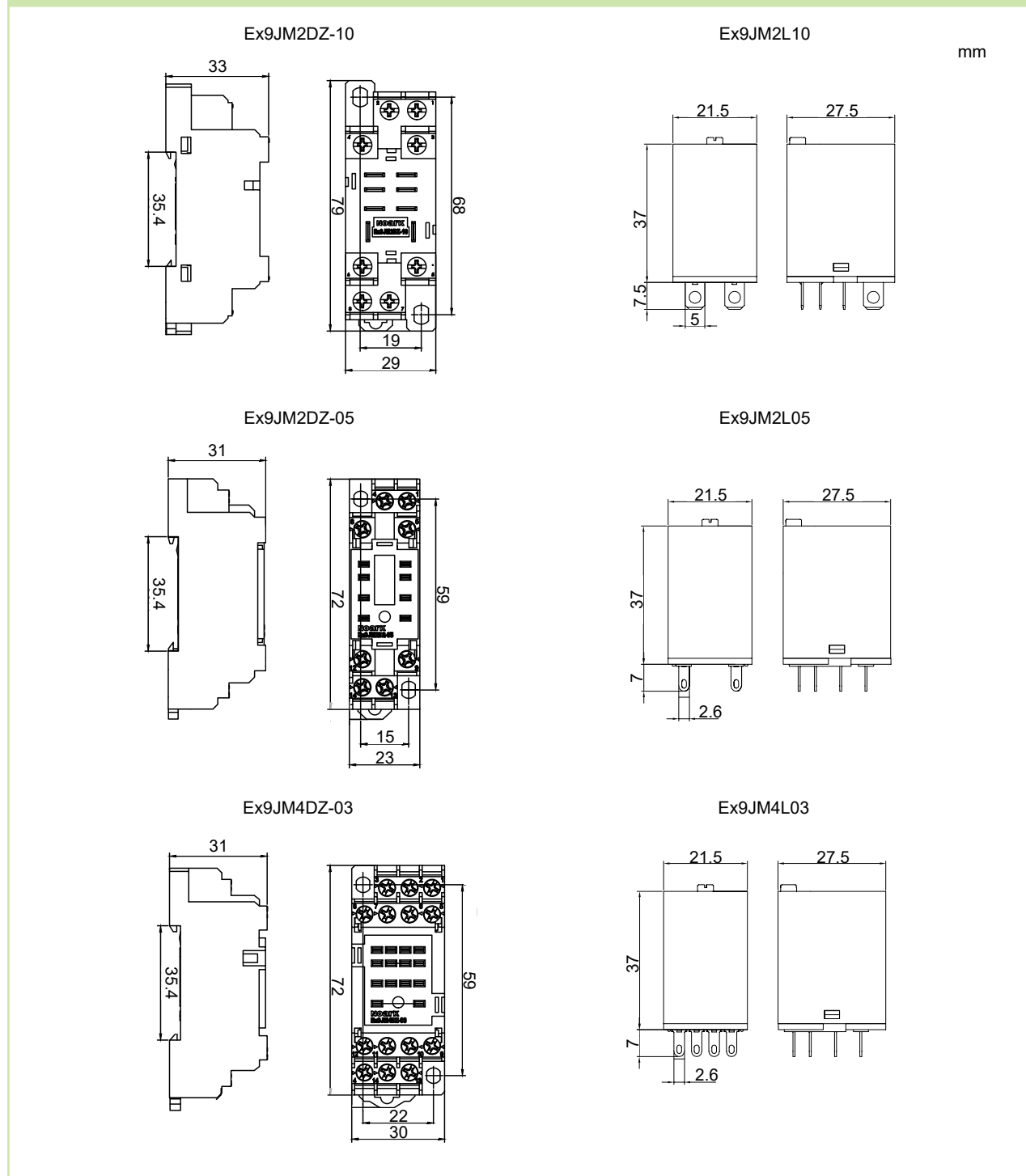

### Wiring diagrams

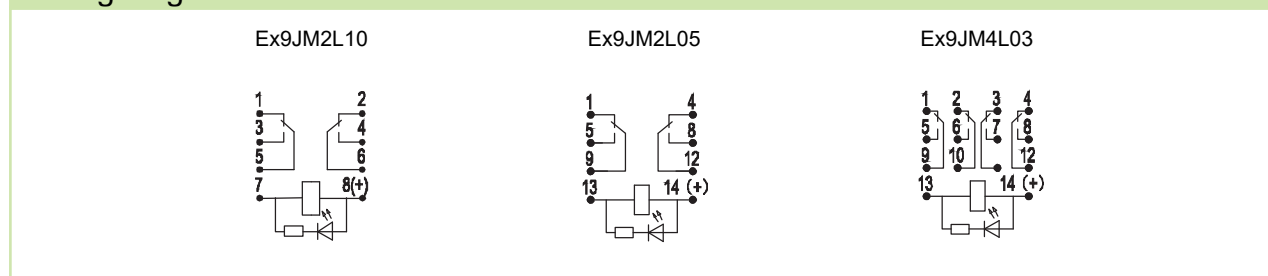

# Technical Data Ex9S32A

## Motor protective circuit breakers Ex9S32A

### General parameters

For protection of various motor applications

Provide overload, short-circuit and phase-failure protection

Can replace the circuit breaker and thermal relay to reduce costs and space

Temperature compensation function to reduce the impact of ambient temperature

#### Accessories

Front-mounted auxiliary contacts	AX51 11, AX51 20	108143, 108144
Side-mounted auxiliary contacts	AX52 11, AX52 20, AX52 02	108145, 108146, 108147
Alarm contact	AL5111	108154
Undervoltage releases	UVT51I, UVT51J, UVT51K	108148, 108149, 108150
Shunt trip releases	SHT51F, SHT51G, SHT51H	108151, 108152, 108153
Max. number of installed accessories are 2 pcs of contact or signal units (2 pcs of AX52 or 1 pc of AX52 + 1 pc of AL5111) or 1 pc of front-mounted contact unit (AX51) and 1 pc of voltage release (SHT51, UVT51)		

### Electrical parameters

Tested according to	IEC/EN 60947-4-1 IEC/EN 60947-2
Rated operating voltage $U_e$	400/690 V AC
Rated frequency $f$	50/60 Hz
Rated insulation voltage $U_i$	690 V
Rated impulse withstand voltage $U_{imp}$	6 kV
Rated current $I_e$	0.16 – 32 A
Fixed rated inst. short-circuit current $I_i$	see table below for exact values
Conventional free air thermal current $I_{th}$	$I_{th} = I_e$
Rated ultimate short-circuit breaking capacity $I_{CU}$ (IEC/EN 60947-2)	
$I_e$ 0.1 – 14 A at 400 V AC	100 kA
$I_e$ 18 – 32 A at 400 V AC	50 kA
$I_e$ 0.16 – 2.5 A at 690 V AC	100 kA
$I_e$ 4 – 32 A at 690 V AC	6 kA
Rated service short-circuit breaking capacity $I_{CS}$ (IEC/EN 60947-2)	
$I_e$ 0.16 – 14 A at 400 V AC	100 kA
$I_e$ 18 – 32 A at 400 V AC	30 kA
$I_e$ 0.16 – 2.5 A at 690 V AC	100 kA
$I_e$ 4 – 32 A at 690 V AC	4 kA
Required contactor type	
$I_e$ 0.1 – 10 A	Ex9CS06/09 or Ex9C12 frame size
$I_e$ 14 – 32 A	Ex9C18/25/32/38 frame size
Maximum operating frequency	30 operating cycles per hour
Electrical service life	100 000 operating cycles (at 400 V AC-3)

# Technical Data Ex9S32A

## Motor protective circuit breakers Ex9S32A

### Mechanical parameters

Device width	45 mm
Device height	97 mm
Device depth	98 mm
Frame size	45 mm
Mounting	easy fastening onto 35 mm device rail (DIN)
Safety arcing distance	50 mm
Degree of protection	IP20
Mechanical service life	100 000 operating cycles
Terminals	lift
Terminal capacity	1 – 10 mm <sup>2</sup>
Fastening torque of terminals	2.5 Nm
Ambient temperature	-5 – +40 °C
Altitude	≤ 2 000 m
Relative humidity	≤ 90 %
Resistance to climatic conditions	class 2, according to EN60068-2-3 and EN60068-2-30
Resistance to mechanical shock	30 gn (shock duration 11 ms)
Resistance to vibrations	5 gn (5 – 150 Hz)
Pollution degree	3
Installation class	III
Weight	0.33 kg

### Dimensions

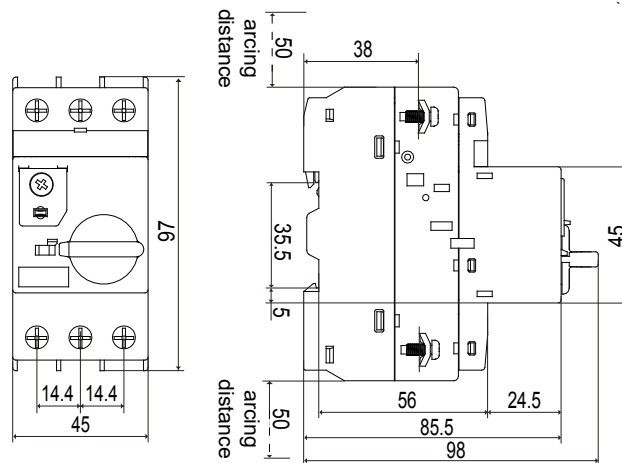

### Mounting positions

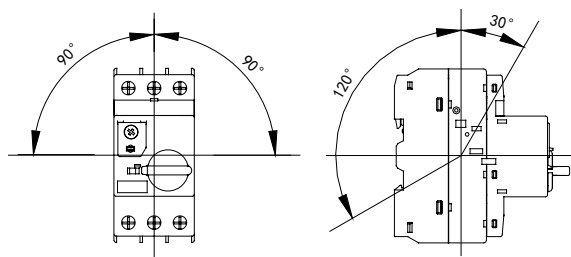

# Technical Data Ex9S32A

## Motor protective circuit breakers Ex9S32A

### Rated instantaneous short-circuit current $I_i$

$I_e$ [A]	0.16 A	0.25 A	0.4 A	0.63 A	1 A	1.6 A	2.5 A	4 A	6.3 A	10 A	14 A	18 A	23 A	25 A	32 A
$I_i$ [A]	2.1	3.2	4.8	7.2	11	20	30	50	72.5	130	175	230	280	280	416

### Rated power of three-phase motor

$I_e$ [A]	AC-3, 50/60 Hz [kW]				
	230 V	400 V	440 V	500 V	690 V
0.16 A	-	-	-	0.06	0.06
0.25 A	-	0.06	0.06	0.09	0.12
0.4 A	0.06	0.09	0.09	0.12	0.18
0.63 A	0.09	0.18	0.18	0.18	0.25
1 A	0.18	0.25	0.25	0.37	0.55
1.6 A	0.25	0.55	0.55	0.75	1.1
2.5 A	0.37	0.75	0.75	1.1	1.5
4 A	0.75	1.5	1.5	2.2	3.0
6.3 A	1.5	2.2	2.2	3.0	4.0
10 A	2.2	4.0	4.0	5.5	7.5
14 A	3.0	5.5	5.5	7.5	11
18 A	4.0	7.5	7.5	11	15
23 A	5.5	11	11	15	18.5
25 A	5.5	11	11	15	22
32 A	7.5	15	15	18.5	30

### Connection diagrams

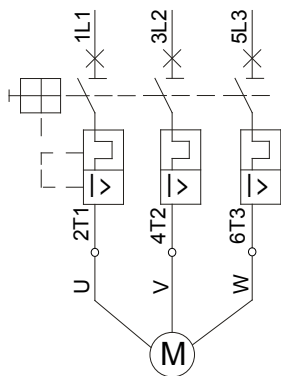

3-phase motor protection

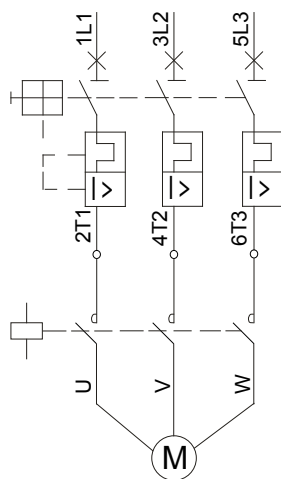

3-phase motor protection with contactor

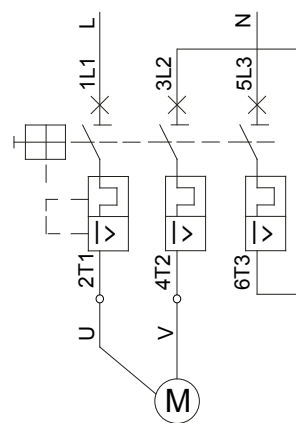

1-phase or DC motor protection

# Technical Data Ex9S32A

## Motor protective circuit breakers Ex9S32A

### Tripping characteristics

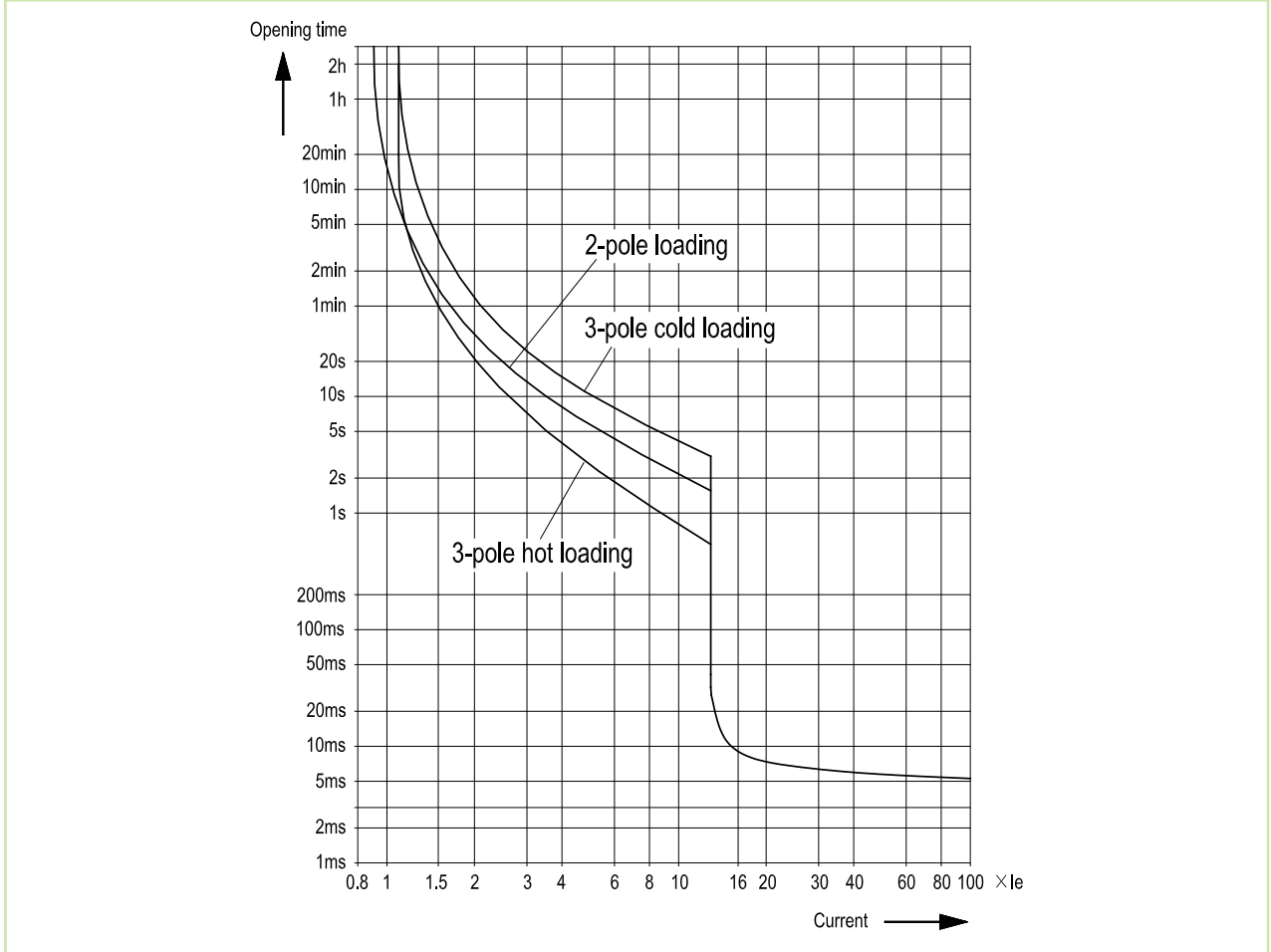

### Power loss

$I_0$ [A]	0.16 A	0.25 A	0.4 A	0.63 A	1 A	1.6 A	2.5 A	4 A	6.3 A	10 A	14 A	18 A	23 A	25 A	32 A
$P$ [W]	5.2	5.5	6.5	6.2	6.4	6.5	5.1	5.8	6.3	7.2	8.5	9.3	12.6	12.6	19.2

# Technical Data Ex9SN25B

## Motor protective circuit breakers

### General parameters

For protection of various motor applications

Provide overload, short-circuit and phase-failure protection

Can replace the circuit breaker and thermal relay to reduce costs and space

Temperature compensation function to reduce the impact of ambient temperature

#### Accessories

Front-mounted auxiliary contacts	ASNB	108954, 108955
Side-mounted auxiliary contacts	ASNA	108956, 108957
Alarm contacts	ASNF	108964, 108965, 108966, 108967
Undervoltage releases	ASNUV	108958, 108959, 108960
Shunt trip releases	ASNT	108961, 108962, 108963
Isolated boxes for surface mounting	ASNE	108968, 108969

Max. number of installed accessories are 2 pcs of contact or signal units (2 pcs ASNA or 1 pc of ASNA + 1 pc of ASNF) or 1 pc of front-mounted contact unit (ASNB) and 1 pc of voltage release (ASNT, ASNUV)

### Electrical parameters

Tested according to	EN 60947-4-1 EN 60947-2
Rated operating voltage $U_e$	230/240, 400/415, 440, 500, 690 V AC
Rated frequency f	50/60 Hz
Rated insulation voltage $U_i$	690 V
Rated impulse withstand voltage $U_{imp}$	8 kV
Rated current $I_e$	0.16 – 25 A
Fixed rated inst. short-circuit current $I_i$	see table below for exact values
Conventional free air thermal current $I_{th}$	$I_{th} = I_e$
Rated ultimate short-circuit breaking capacity $I_{CU}$ (EN 60947-2)	
$I_e$ 0.1 – 18 A at 230/240 V AC	100 kA
$I_e$ 17 – 25 A at 230/240 V AC	50 kA
$I_e$ 0.1 – 10 A at 400/415 V AC	100 kA
$I_e$ 9 – 25 A at 400/415 V AC	15 kA
$I_e$ 0.1 – 1.6 A at 660/690 V AC	100 kA
$I_e$ 1.6 – 25 A at 660/690 V AC	3 kA
Rated service short-circuit breaking capacity $I_{CS}$ (EN 60947-2)	
$I_e$ 0.1 – 18 A at 230/240 V AC	100 kA
$I_e$ 17 – 25 A at 230/240 V AC	50 kA
$I_e$ 0.1 – 6.3 A at 400/415 V AC	100 kA
$I_e$ 6 – 18 A at 400/415 V AC	7.5 kA
$I_e$ 17 – 25 A at 400/415 V AC	6 kA
$I_e$ 0.1 – 1.6 A at 660/690 V AC	100 kA
$I_e$ 1.6 – 25 A at 660/690 V AC	2.25 kA
Required contactor type	
$I_e$ 0.1 – 10 A	Ex9CS06/09 or Ex9C12 frame size
$I_e$ 14 – 25 A	Ex9C18/25 frame size
Maximum operating frequency	30 operating cycles per hour
Electrical service life	2 000 operating cycles (at 400 V AC-3)
Power loss	9 W



# Technical Data Ex9SN25B

## Motor protective circuit breakers

### Mechanical parameters

Device width	44.5 mm
Device height	91.3 mm
Device depth	81 mm
Frame size	45 mm
Mounting	easy fastening onto 35 mm device rail (DIN)
Safety arcing distance	40 mm
Degree of protection	IP20
Mechanical service life	10 000 operating cycles
Terminals	lift
Terminal capacity	1 – 6 mm <sup>2</sup>
Fastening torque of terminals	1.7 Nm
Ambient temperature	-5 – +40 °C
Altitude	≤ 2 000 m
Relative humidity	≤ 50 %
Resistance to climatic conditions	class 2, according to EN 60068-2-3 and EN 60068-2-30
Resistance to mechanical shock	30 gn (shock duration 11 ms)
Resistance to vibrations	5 gn (5 – 150 Hz)
Pollution degree	3
Overvoltage class	III
Weight	0.33 kg

### Dimensions

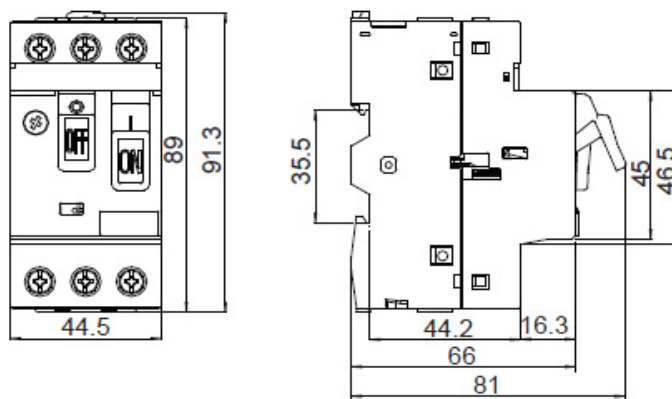

### Mounting positions

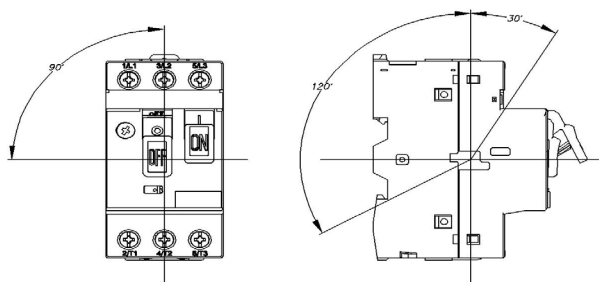

# Technical Data Ex9SN25B

## Motor protective circuit breakers Ex9SN25B

### Rated instantaneous short-circuit current $I_i$

$I_o$ [A]	0.16 A	0.25 A	0.40 A	0.63 A	1 A	1.6 A	2.5 A	4.0 A	6.3 A	10 A	14 A	18 A	23 A	25 A
$I_i$ [A]	1.5	2.4	5	8	13	22.5	33.5	51	78	138	170	223	327	327

### Rated power of three-phase motor

$I_o$ [A]	AC-3, 50/60 Hz [W]					
	230/240 V	400 V	415 V	440 V	500 V	690 V
0.16 A	-	-	-	-	-	-
0.25 A	-	-	-	-	-	-
0.40 A	-	-	-	-	-	-
0.63 A	-	-	-	-	-	0.37
1 A	-	-	-	0.37	0.37	0.55
1.6 A	-	0.37	-	0.55	0.75	1.1
2.5 A	0.37	0.75	0.75	1.1	1.1	1.5
4.0 A	0.75	1.5	1.5	1.5	2.2	3.0
6.3 A	1.1	2.2	2.2	3.0	3.7	4.0
10 A	2.2	4.0	4.0	4.0	5.5	7.5
14 A	3.0	5.5	5.5	7.5	7.5	9
18 A	4.0	7.5	9	9	9	11
23 A	5.5	11	11	11	11	15
25 A	5.5	11	11	11	15	18.5

### Maximum value of backup fuse for short-circuit protection for $I_{cc} > I_{cu}$

$I_o$ [A]	230/240 V		400/415 V		440 V		500 V		690 V	
	aM A	gL/gG A	aM A	gL/gG A	aM A	gL/gG A	aM A	gL/gG A	aM A	gL/gG A
0.16 A	-	-	-	-	-	-	-	-	-	-
0.25 A	-	-	-	-	-	-	-	-	-	-
0.40 A	-	-	-	-	-	-	-	-	-	-
0.63 A	-	-	-	-	-	-	-	-	-	-
1 A	-	-	-	-	-	-	-	-	-	-
1.6 A	-	-	-	-	-	-	-	-	-	-
2.5 A	-	-	-	-	-	-	-	-	16	20
4.0 A	-	-	-	-	-	-	-	-	25	32
6.3 A	-	-	-	-	50	63	50	63	32	40
10 A	-	-	-	-	50	63	50	63	32	40
14 A	-	-	63	80	50	63	50	63	40	50
18 A	-	-	63	80	50	63	50	63	40	50
23 A	80	100	80	100	63	80	50	63	40	50
25 A	80	100	80	100	63	80	50	63	40	50

# Technical Data Ex9SN25B

## Motor protective circuit breakers Ex9SN25B

### Tripping characteristics

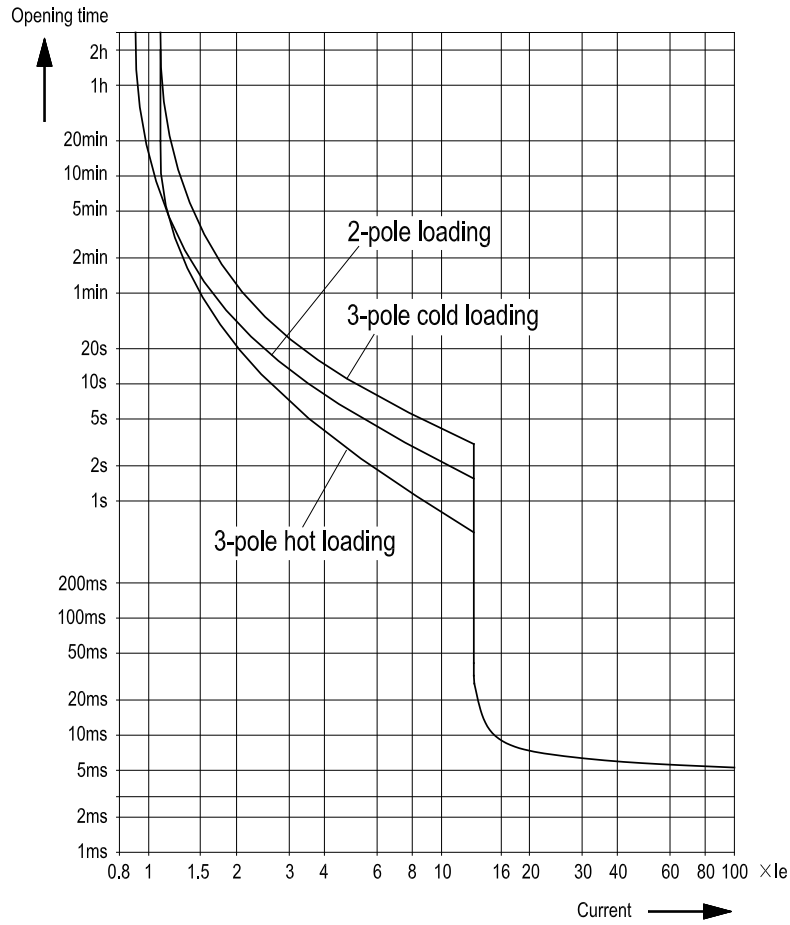

### Connection diagram

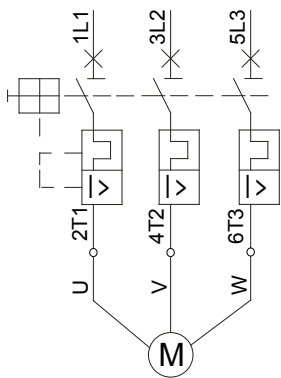

3-phase motor protection

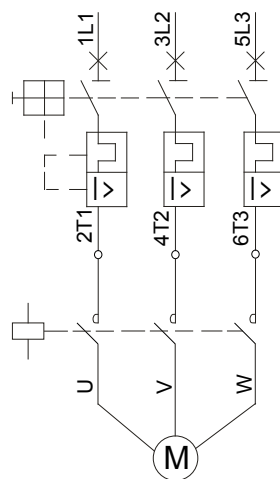

3-phase motor protection with contactor

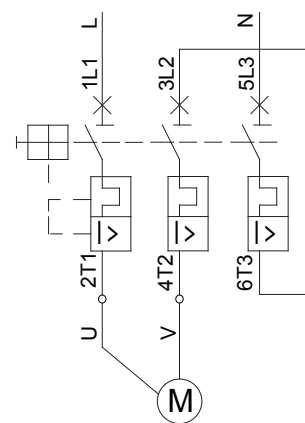

1-phase or DC motor protection

# Technical Data Ex9R

## Overload thermal relays Ex9R12, Ex9R38, Ex9R100

### General parameters

Thermal overload relays		
Ex9R12 for direct mounting onto Contactors Ex9CS		
Ex9R38B for direct mounting onto Contactors frame size 18, 38 (with spacer)		
Ex9R100 for direct mounting onto Contactors frame size 65, 100		
For stand-alone applications by means of adaptor AD5.		
Suitable mainly for motor protection against overload or phase lost		
With built-in auxiliary contacts 1 NO + 1 NC		
Accessories		
Adaptors for stand-alone use	AD51, AD56, AD53	101436, 110339, 101438

### Electrical parameters

	Ex9R12	Ex9R38	Ex9R100
Tested according to	IEC/EN 60947-4-1		
Rated op. voltage $U_e$	690 V AC		
Rated insulating voltage $U_i$	690 V AC		
Rated impulse withstand voltage $U_{imp}$	6 kV	6 kV	6 kV
Rated frequency	50/60 Hz		
Tripping Class	10A	10A	10A
Current setting range (per frame size)	0.1 — 12 A	1 — 38 A	23 — 100 A
Tripping threshold	$1.14 \pm 0.06 \times I_n$		
Phase failure detection	30 % in a phase		
Maximum short circuit protection fuse	25 A gG/gL	80 A gG/gL	160 A gG/gL
Reset	Manual or Auto		
Min. op. voltage per AX contact $U_{min}$	17 V AC, 3 V DC		
Rated thermal current $I_{th}$ of AX cont.	5 A 600 V AC, 1 A 300 V DC		
Rated op. current $I_e$ , AC-15 of AX	1.64 A / 230 V, 0.95 A / 400 V		
Rated op. current $I_e$ , DC-13 of AX	0.13 A / 220 V		
Min. operational current $I_{min}$ of AX	5 mA AC, 5 mA DC		
Max. back-up fuse of AX	6 A gG/gL, 6 A MCB char. B		
Conditional short circuit current $I_k$ with max. back-up fuse of AX	1 kA		

### Mechanical parameters

	Ex9R12	Ex9R38	Ex9R100
Tripping indicator	yellow	yellow	yellow
Device width	45 mm	45 mm	72 mm
Device height	72 mm	65.5 mm	80 mm
Device depth	68 mm	94 mm	117 mm
Mounting onto	Ex9CS, AD51	Ex9C09 — 38, AD56	Ex9C40 — 100, AD53
Degree of protection	IP20		
Terminals	lift		
Terminal capacity	1 — 4 mm <sup>2</sup>	1 — 10 mm <sup>2</sup>	4 — 35 mm <sup>2</sup>
Fastening torque of terminals	1.7 Nm	2.5 Nm	9 Nm
Weight	0.16 kg	0.14 kg	0.51 kg
Vibration resistance IEC 68-2-6	2 g, 5 — 300 Hz		
Shock resistance IEC 68-2-27	15 g, 11 ms		

# Technical Data Ex9R

## Overload thermal relays Ex9R12, Ex9R38, Ex9R100

### Dimensions

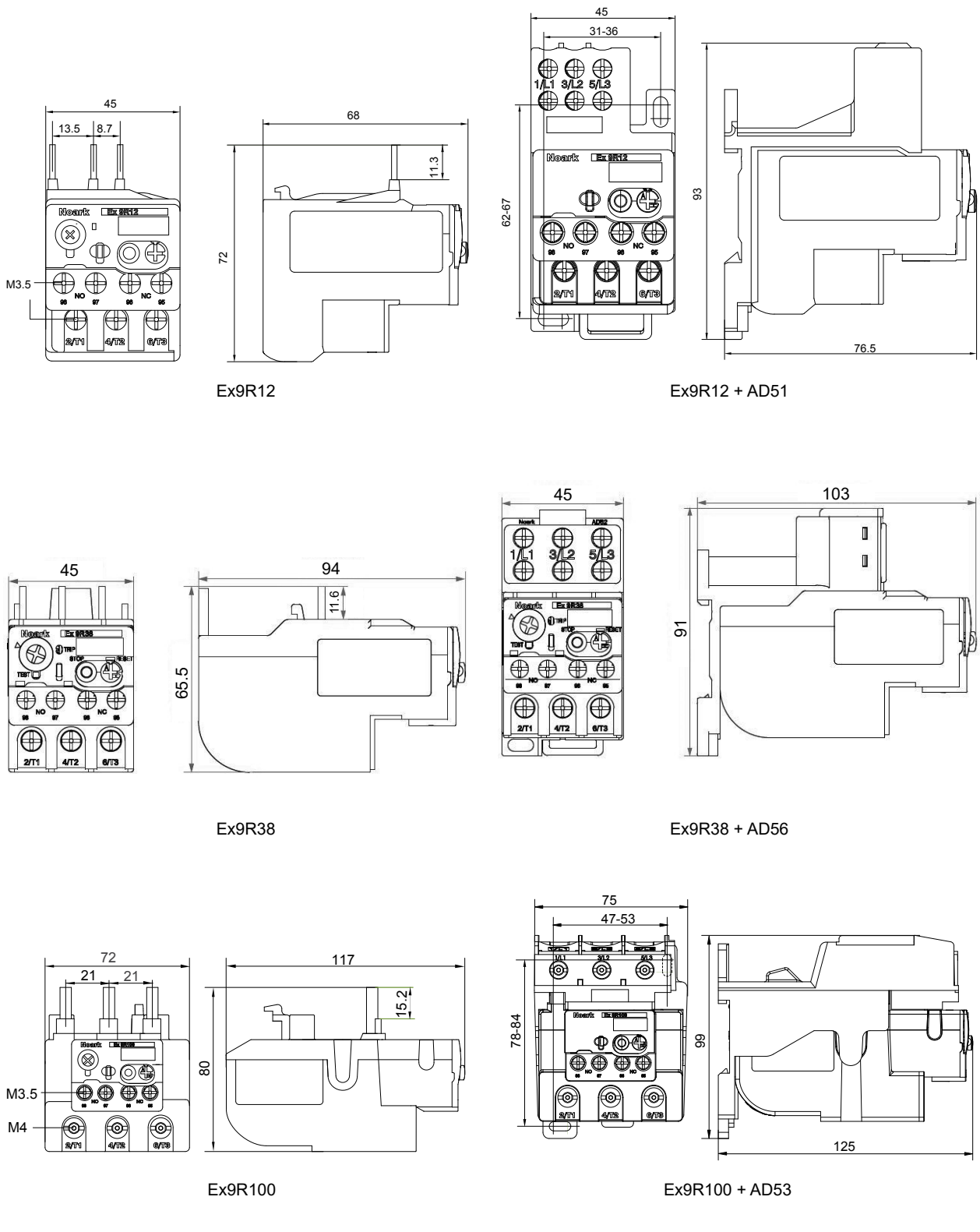

# Technical Data Ex9R

## Overload thermal relays Ex9R12, Ex9R38, Ex9R100

### Wiring diagrams

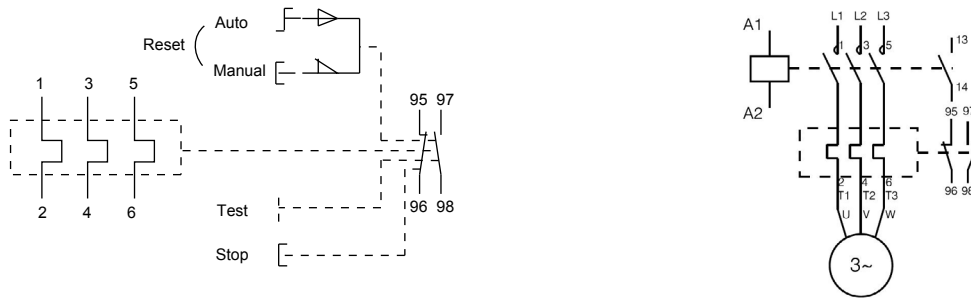

### Tripping characteristics

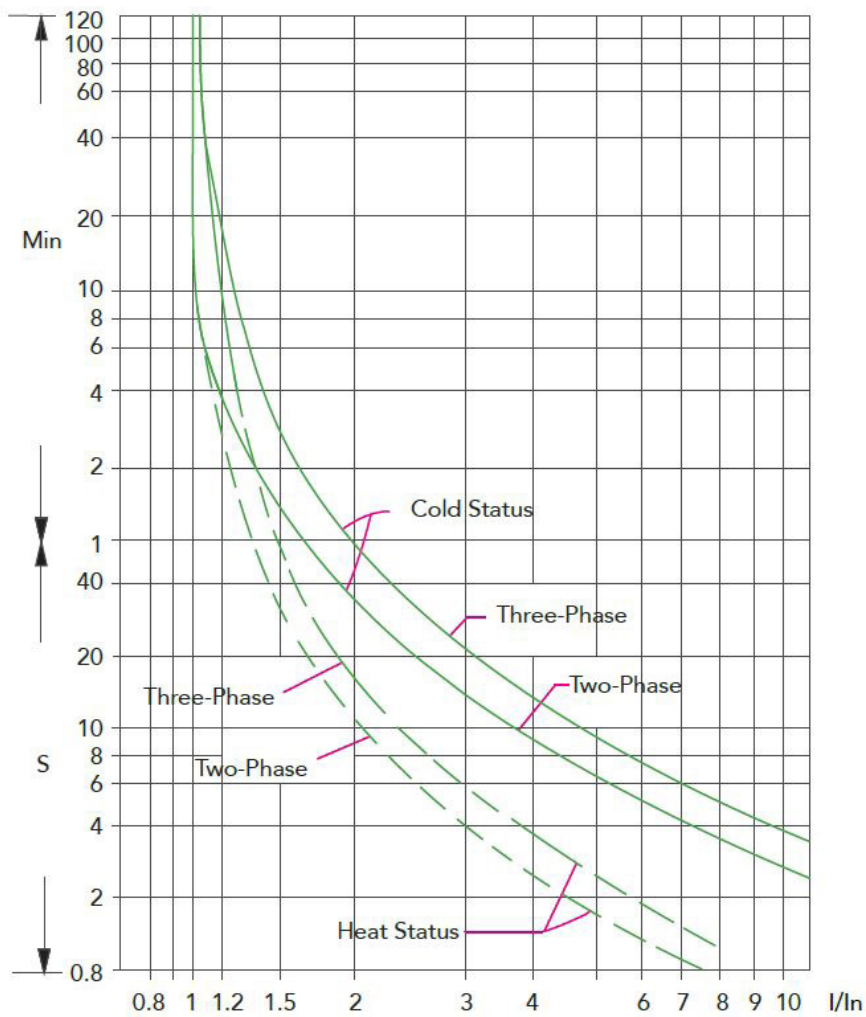

# Technical Data Ex9R500

## Overload thermal relays Ex9R185, Ex9R500

### General parameters

Overload thermal relays

Ex9R185 for direct mounting onto contactors of frame size Ex9C185

Ex9R500 for direct mounting onto contactors of frame size Ex9C300, Ex9C500

For stand-alone applications by means of adaptor AD5

Suitable mainly for motor protection against overload or phase lost

With built-in auxiliary contacts 1NO + 1NC

Accessories

Adaptors for stand-alone use	AD54, AD55	107968, 107969
------------------------------	------------	----------------

### Electrical parameters

	Ex9R185	Ex9R500
Tested according to	IEC/EN 60947-4-1	
Rated operating voltage $U_e$	690 V AC	
Rated insulating voltage $U_i$	690 V AC	
Rated impulse withstand voltage $U_{imp}$	6 kV	6 kV
Rated frequency	50/60 Hz	
Tripping Class	10A	10A
Current setting range $I_r$ (per frame size)	80 — 185 A	160 — 500 A
Tripping threshold	$1.14 \pm 0.06 \times I_r$	
Phase failure detection	30 % in a phase	
Maximum short circuit protection fuse	315 A gG/gL	800 A gG/gL
Reset	Manual or Auto	
Minimum operating voltage $U_{min}$ of AX	17 V AC / 3 V DC	
Rated thermal current $I_{th}$ of AX	5 A	
Rated op. current $I_e$ , AC-15 of AX	1.64 A / 230 V, 0.95 A / 400 V	
Rated op. current $I_e$ , DC-13 of AX	0.13 A / 220 V	
Min. operational current $I_{min}$ of AX	5 mA AC, 5 mA DC	
Max. back-up fuse of AX	6 A gG/gL, 6 A MCB char. B	
Conditional short circuit current $I_k$ with max. back-up fuse of AX	1 kA	

### Mechanical parameters

	Ex9R185	Ex9R500
Tripping indicator	blank-yellow	blank-yellow
Device width	120 mm	145 mm
Device height	133 mm	149 mm
Device depth	136 mm	146 mm
Mounting onto	Ex9C115 — 185, AD54	Ex9C225 — 500, AD55
Degree of protection	IP20	
Terminals	connection plates for M8 screw	connection plates for M10 screw
Terminal capacity	25 — 95 mm <sup>2</sup>	50 — 240 mm <sup>2</sup>
Fastening torque of terminals	18 Nm	35 Nm
Altitude	≤ 2000 m	
Relative humidity	≤ 90 %	
Ambient temperature	-20 — +55 °C	
Weight	1.5 kg	1.9 kg
Vibration resistance IEC 68-2-6	2 g, 5 — 300 Hz	
Shock resistance IEC 68-2-27	15 g, 11 ms	

# Technical Data Ex9R500

## Overload thermal relays Ex9R185, Ex9R500

### Dimensions

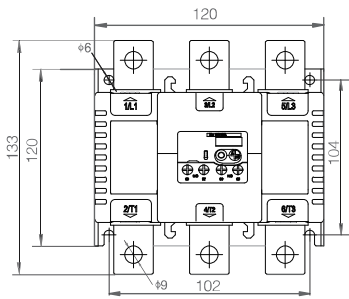

**Ex9R185**

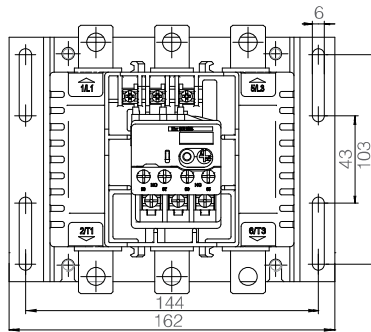
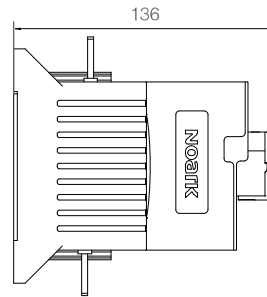

**Ex9R185 + AD54**

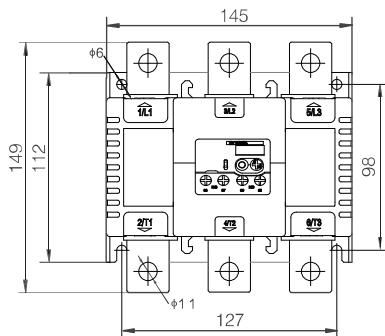
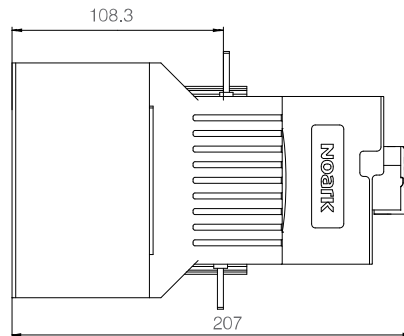

**Ex9R500**

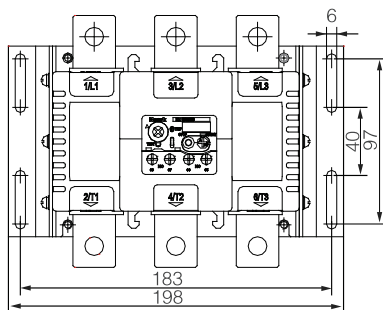
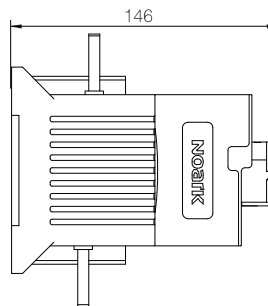

**Ex9R500 + AD55**

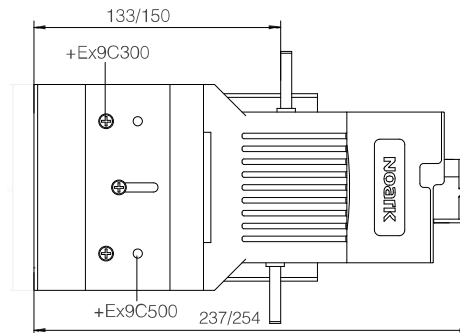



# Technical Data Ex9R500

## Overload thermal relays Ex9R185, Ex9R500

### Wiring diagrams

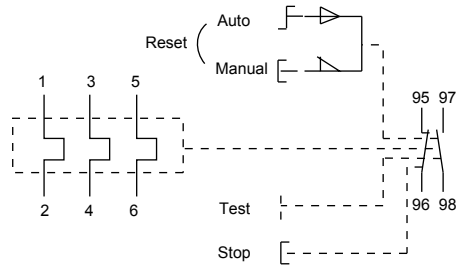

### Tripping characteristics

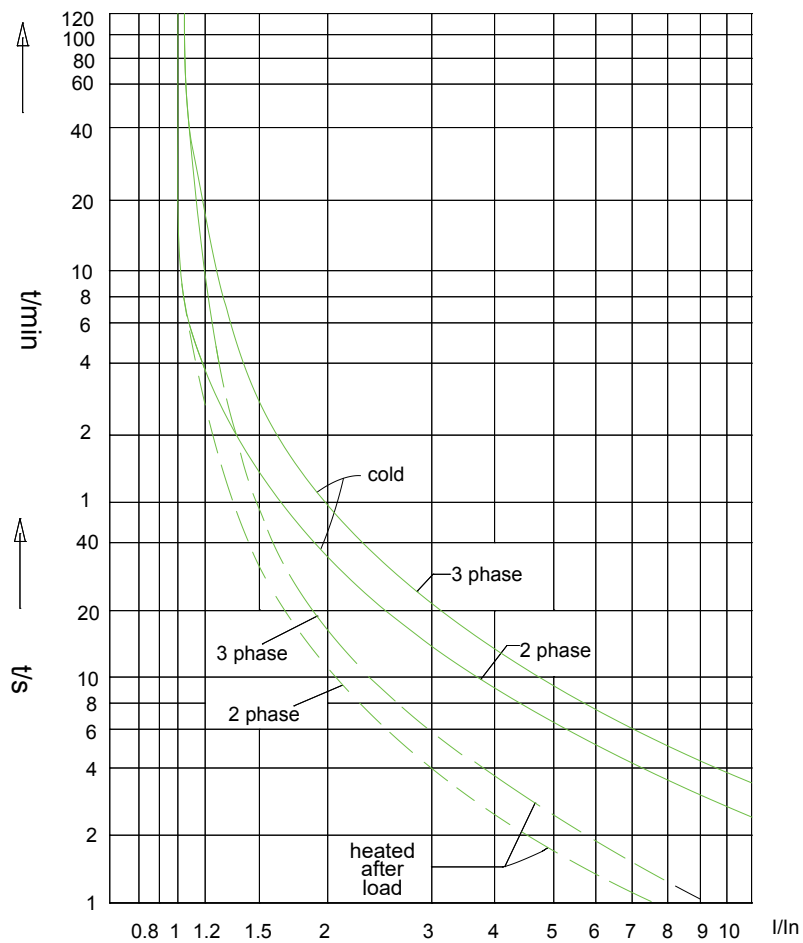

# Technical Data Ex9C accessories

## Accessories for miniature contactors Ex9CS/Ex9CSR line

### Front-mounted auxiliary contact units AX41

#### General parameters

Auxiliary contacts for Miniature Contactors Ex9CS and Ex9CSR, for subsequent mounting

Front-mounted version

1 unit can be used with a contactor

Do not limit a possibility to install overload relay Ex9R12

#### Electrical parameters

	AX4104	AX4113	AX4122	AX4131	AX4140
Contacts	4 NC	1 NO + 3 NC	2 NO + 2 NC	3 NO + 1 NC	4 NO
Tested according to	IEC/EN 60947-5-1				
Rated op. voltage $U_e$	120 / 240 / 380 / 480 / 600 V AC, 125 / 250 V DC				
Min. op. voltage per contact $U_{min}$	17 V AC, 3 V DC				
Rated frequency	50 Hz				
Rated thermal current $I_{th}$	10 A				
Rated op. current $I_e$ , ut. cat. AC-15	6A / 120 V, 3 A / 240 V, 1.9 A / 380 V, 1.5 A / 480 V, 1.2 A / 600 V				
Rated op. current $I_e$ , ut. cat. DC-13	0.55 A / 125 V, 0.27 A / 250 V				
Min. operational current $I_{min}$	5 mA AC, 5 mA DC				
Rated impulse withstand voltage $U_{imp}$	6 kV (1.2/50 ms)				
Rated insulation voltage $U_i$	690 V				
Max. back-up fuse	10 A gG/gL				
Conditional short circuit current $I_k$ with max. back-up fuse	1 kA				

#### Mechanical parameters

	AX4104	AX4113	AX4122	AX4131	AX4140
Device width	33 mm				
Device height	39 mm				
Device depth	37 mm				
Mounting	front				
Degree of protection	IP20				
Terminals	lift				
Terminal capacity	1 — 6 mm <sup>2</sup>				
Fastening torque of terminals	1 Nm				

# Technical Data Ex9C accessories

## Accessories for miniature contactors Ex9CS/Ex9CSR line

### Front-mounted auxiliary contact units AX41

#### Dimensions

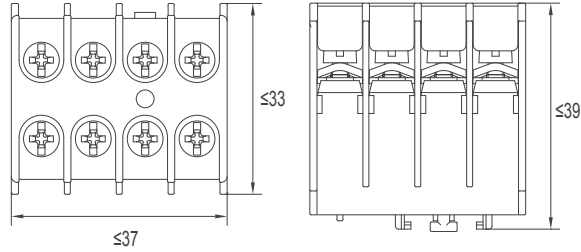

#### Wiring diagrams

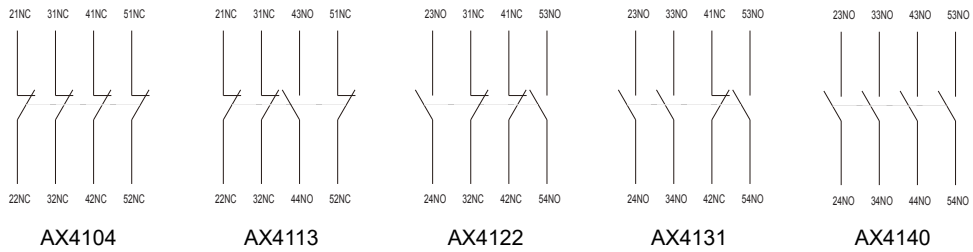

# Technical Data Ex9C accessories

## Accessories for contactors Ex9C line

### Front-mounted auxiliary contact units AX42

#### General parameters

Auxiliary contacts for contactors line Ex9C and Ex9CR, for subsequent mounting

Front-mounted version

1 unit can be used with a contactor

Do not limit the possibility of installing overload relay Ex9R

#### Electrical parameters

	AX4202	AX4211	AX4220	AX4204	AX4213	AX4222	AX4231	AX4240
Contacts	2 NC	1NO+1NC	2 NO	4 NC	1NO+3NC	2NO+2NC	3NO+1NC	4 NO
Tested according to	IEC/EN 60947-5-1							
Rated op. voltage $U_e$	120 / 240 / 380 / 480 / 600 V AC, 125 / 250 V DC							
Min. op. voltage per contact $U_{min}$	17 V AC, 3 V DC							
Rated frequency	50 Hz							
Rated thermal current $I_{th}$	10 A							
Rated op. current $I_e$ , ut. cat. AC-15	6 A / 120 V, 3 A / 240 V, 1.9 A / 380 V, 1.5 A / 480 V, 1.2 A / 600 V							
Rated op. current $I_e$ , ut. cat. DC-13	0.55 A / 125 V, 0.27 A / 250 V							
Min. operational current $I_{min}$	5 mA AC, 5 mA DC							
Rated impulse withstand voltage $U_{imp}$	6 kV (1.2/50 ms)							
Rated insulation voltage $U_i$	690 V							
Max. back-up fuse	10 A gG/gL							
Conditional short circuit current $I_k$ with max. back-up fuse	1 kA							

#### Mechanical parameters

	AX4202	AX4211	AX4220	AX4204	AX4213	AX4222	AX4231	AX4240
Device width	48 mm			48 mm				
Device height	37 mm			37 mm				
Device depth	26 mm			45 mm				
Mounting	front							
Degree of protection	IP20							
Terminals	lift							
Terminal capacity	1 — 6 mm <sup>2</sup>							
Fastening torque of terminals	1 Nm							

# Technical Data Ex9C accessories

## Accessories for contactors Ex9C line

### Front-mounted auxiliary contact units AX42

#### Dimensions

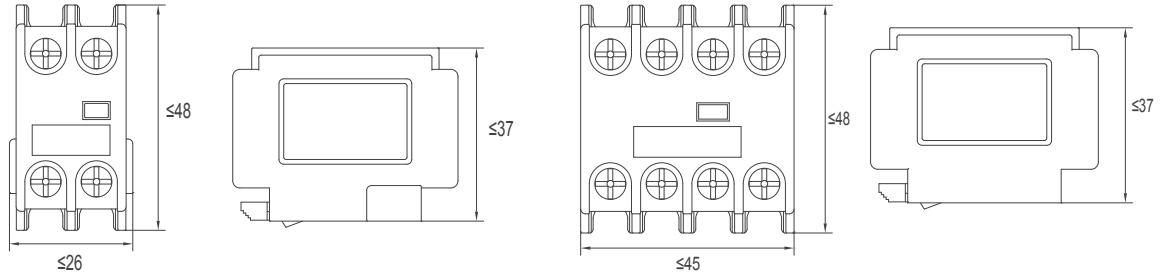

AX4202, AX4211, AX4220

AX4204, AX4213, AX4222, AX4231, AX4240

#### Wiring diagrams

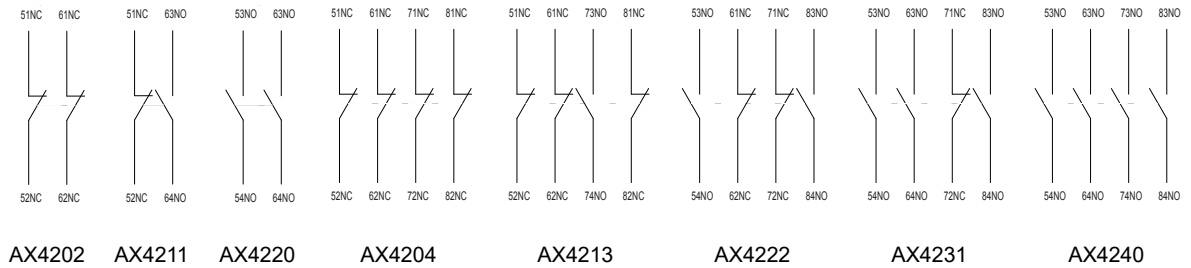

# Technical Data Ex9C accessories

Accessories for contactors Ex9C line, frame sizes Ex9C18, Ex9C38, Ex9C65, Ex9C100

## Side-mounted auxiliary contact units AX4311

### General parameters

Auxiliary contacts for contactors line Ex9C and Ex9CR, for subsequent mounting

Side-mounted version

1 unit can be used with a contactor at the left, another unit at the right

Do not limit the possibility of installing overload relay Ex9R

### Electrical parameters

	<b>AX4311</b>
Contacts	1 NO + 1 NC
Tested according to	IEC/EN 60947-5-1
Rated op. voltage $U_e$	120 / 240 / 380 / 480 / 600 V AC, 125 / 250 V DC
Min. op. voltage per contact $U_{min}$	17 V AC, 3 V DC
Rated frequency	50 Hz
Rated thermal current $I_{th}$	10 A
Rated op. current $I_e$ , ut. cat. AC-15	6 A / 120 V, 3 A / 240 V, 1.9 A / 380 V, 1.5 A / 480 V, 1.2 A / 600 V
Rated op. current $I_e$ , ut. cat. DC-13	0.55 A / 125 V, 0.27 A / 250 V
Min. operational current $I_{min}$	5 mA AC, 5 mA DC
Rated impulse withstand voltage $U_{imp}$	6 kV (1.2/50 ms)
Rated insulation voltage $U_i$	690 V
Max. back-up fuse	10 A gG/gL
Conditional short circuit current $I_k$ with max. back-up fuse	1 kA

### Mechanical parameters

	<b>AX4311</b>
Device width	11 mm
Device height	69 mm
Device depth	70 mm
Mounting	side
Degree of protection	IP20
Terminals	lift
Terminal capacity	1 — 6 mm <sup>2</sup>
Fastening torque of terminals	1 Nm

# Technical Data Ex9C accessories

Accessories for contactors Ex9C line, frame sizes Ex9C18, Ex9C38, Ex9C65, Ex9C100

## Side-mounted auxiliary contact units AX4311

### Dimensions

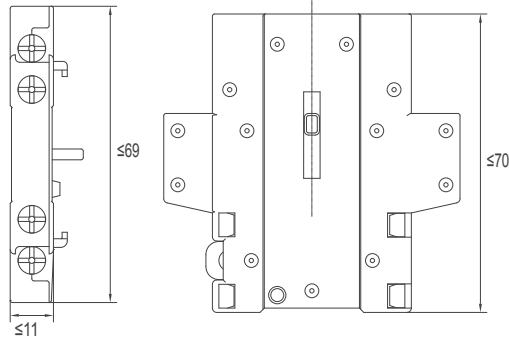

### Wiring diagrams

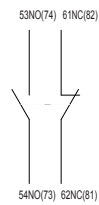

AX4311

# Technical Data Ex9C accessories

## Accessories for contactors Ex9C line

### Pneumatic time delay block TDD4

#### General parameters

Pneumatic time delay block with delayed auxiliary contact operations (ON and OFF delay types)

Suitable for contactors line Ex9C and Ex9CR, for front subsequent mounting

1 unit can be used with a contactor

Do not limit the possibility of installing overload relay Ex9R

#### Electrical parameters

Contacts	1NO + 1NC
Delay type	ON, OFF
Time delay	0.1 - 3 s (A) 0.1 - 30 s (B) 10 - 180 s (C)
Rated operational voltage $U_e$	400 / 690 V AC 220 V DC
Minimum switching capacity	17 V / 5 mA
Rated frequency	50 Hz
Rated thermal current $I_{th}$	10 A
Rated op. current $I_e$ , ut. cat. AC-15	3 A / 120 V, 1.5 A / 240 V, 0.95 A / 380 V, 0.6 A / 600 V, 0.52 A / 660 V
Rated op. current $I_e$ , ut. cat. DC-13	0.26 A / 125 V, 0.15 A / 250 V
Rated making capacity $U_e \times I_e$	3600 VA AC / 33 W DC
Rated breaking capacity $U_e \times I_e$	360 VA AC / 33 W DC
Min. operational current $I_{min}$	5 mA AC/DC
Rated impulse withstand voltage $U_{imp}$	6 kV
Rated insulation voltage $U_i$	660 V
Max. back-up fuse	10 A gG/gL
Conditional short circuit current $I_k$ with max. back-up fuse	1 kA

#### Mechanical parameters

Device width	45 mm
Device height	52 mm
Device depth	60 mm
Mounting	front
Mechanical service life	3 000 000 operating cycles
Degree of protection	IP20
Terminals	lift
Terminal capacity	1 — 2.5 mm <sup>2</sup>
Fastening torque of terminals	0.8 Nm
Weight	0.06 kg



# Technical Data Ex9C accessories

## Accessories for contactors Ex9C line

### Pneumatic time delay blocks TDD4

#### Dimensions

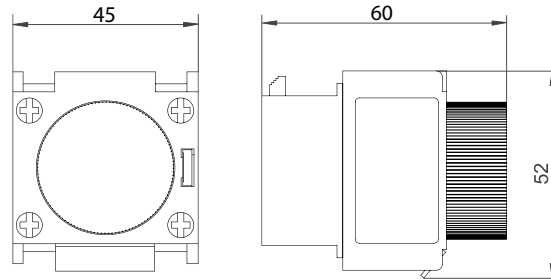

#### Wiring diagram

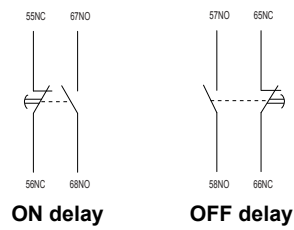

# Technical Data Ex9C accessories

## Accessories for contactors Ex9C line

### Surge suppressor blocks CCU4

#### General parameters

Reduces voltage peaks in control circuit

Suitable for contactors line Ex9C, Ex9CR and Ex9CC, for subsequent mounting

Includes cable lugs for connecting to contactor terminals

Do not limit the possibility of installing other accessories

#### Electrical parameters

	CCU41	CCU42	CCU43
Internal technology	varistor	RC circuit	RC circuit
Control coil voltage $U_c$ (protection range)		380 - 415 V AC 110 - 240 V AC 24 - 48 V AC	
Maximal peak voltage $U_p$		$3 U_c$	

#### Mechanical parameters

	CCU41	CCU42	CCU43
Suitable for	Ex9CS06-12	Ex9C09-38 Ex9CC09-38	Ex9C40-100 Ex9CC50-100
Mounting	subsequent into contactor control coil terminals		
Weight	0.02 kg		

#### Wiring diagram

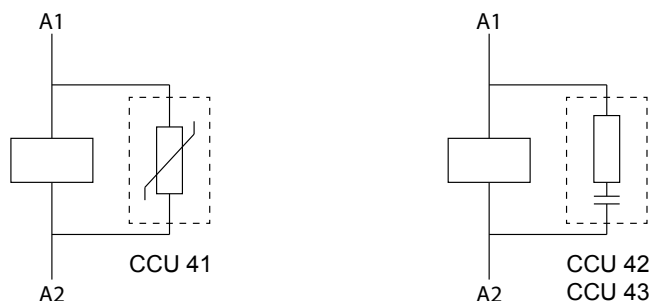

# Technical Data Ex9C500 accessories

## Accessories for contactors Ex9C line, frame sizes Ex9C185, Ex9C300, Ex9C500

### Side-mounted auxiliary contact units AX44

#### General parameters

Auxiliary contacts for contactors of frame size Ex9C115-500, for subsequent mounting

Side-mounted version

1 unit can be used with a contactor at the left, another unit at the right side

Do not limit the possibility of installing front-mounted auxiliary contact unit AX42 or overload relay Ex9R

#### Electrical parameters

	<b>AX4411</b>	<b>AX4402</b>	<b>AX4420</b>
Contacts	1 NO + 1 NC	2 NC	2 NO
Tested according to	IEC/EN 60947-5-1		
Rated op. voltage $U_e$	24 / 230 / 400 / 690 V AC 125 / 250 V DC		
Min. op. voltage per contact $U_{min}$	17 V AC, 3 V DC		
Rated frequency	50 Hz		
Rated thermal current $I_{th}$	10 A		
Rated op. current $I_e$ , ut. cat. AC-15	6 A at 24 V, 3.13 A at 230 V, 1.8 A at 400 V, 1.04 A at 690 V		
Rated op. current $I_e$ , ut. cat. DC-13	0.55 A at 125 V, 0.27 A at 250 V		
Min. operational current $I_{min}$	5 mA AC, 5 mA DC		
Rated impulse withstand voltage $U_{imp}$	6 kV (1.2/50 ms)		
Rated insulation voltage $U_i$	690 V		
Max. back-up fuse	10 A gG/gL		
Conditional short circuit current $I_k$ with max. back-up fuse	1 kA		

#### Mechanical parameters

	<b>AX44</b>
Device width	10 mm
Device height	64 mm
Device depth	68 mm
Mounting	side
Degree of protection	IP20
Terminals	lift
Terminal capacity	1 — 4 mm <sup>2</sup>
Fastening torque of terminals	1.7 Nm

# Technical Data Ex9C500 accessories

Accessories for contactors Ex9C line, frame sizes Ex9C185, Ex9C300, Ex9C500

## Side-mounted auxiliary contact units AX44

### Dimensions

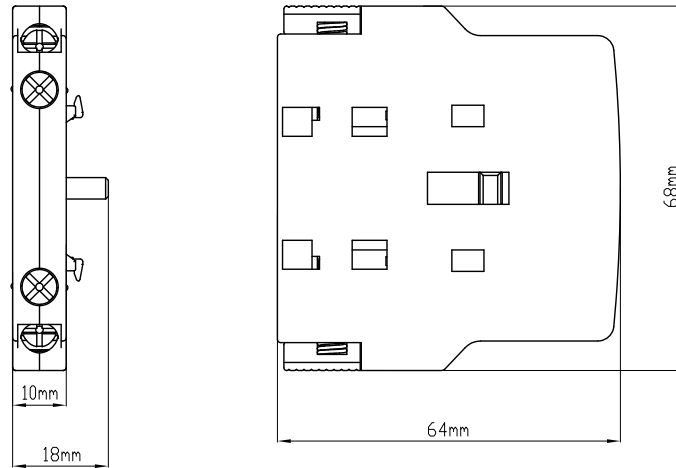

### Wiring diagrams



AX4402

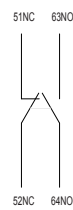

AX4411

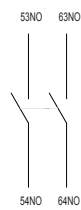

AX4420

# Technical Data Ex9S32A accessories

## Accessories for motor protective circuit breakers Ex9S32A line

### Front-mounted auxiliary contact unit AX51

#### General parameters

For subsequent mounting

Front-mounted version

1 unit can be used with a motor protective circuit breaker

#### Electrical parameters

	AX51 11	AX51 20
Contacts	1 NO + 1 NC	2 NO
Tested according to	IEC/EN 60947-5-1	
Rated operating voltage $U_e$	240 V AC, 60 V DC	
Rated frequency	50/60 Hz	
Rated thermal current $I_{th}$	2.5 A	
Rated op. current $I_e$ , ut. cat. AC-15	0.5 A at 240 V	
Rated op. current $I_e$ , ut. cat. DC-13	0.15 A at 60 V	
Rated impulse withstand voltage $U_{imp}$	2.5 kV	
Rated insulation voltage $U_i$	250 V	
Max. back-up fuse	4A gG/gL	

#### Mechanical parameters

	AX51 11	AX51 20
Device width	45 mm	
Device height	14 mm	
Device depth	32.5 mm	
Mounting	front	
Degree of protection	IP20	
Terminals	lift	
Terminal capacity	1 – 2.5 mm <sup>2</sup>	
Fastening torque of terminals	0.8 Nm	

#### Wiring diagram

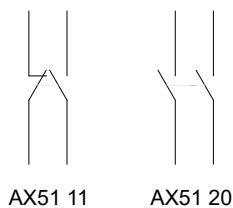

# Technical Data Ex9S32A accessories

## Accessories for motor protective circuit breakers Ex9S32A line

### Side-mounted auxiliary contact unit AX52

#### General parameters

For subsequent mounting

Side-mounted version, mounting from the left

Up to 2 units can be used with a motor protective circuit breaker

#### Electrical parameters

	AX52 11	AX52 20	AX52 02
Contacts	1 NO + 1 NC	2 NO	2 NC
Tested according to	IEC/EN 60947-5-1		
Rated operating voltage $U_e$	240 V AC, 415 V AC, 250 V DC, 400 V DC		
Rated frequency $f$	50/60 Hz		
Rated thermal current $I_{th}$	5 A		
Rated op. current $I_e$ , ut. cat. AC-15	1.5 A at 240 V, 1 A at 415 V		
Rated op. current $I_e$ , ut. cat. DC-13	0.2 A at 250 V, 0.1 A at 400 V		
Rated impulse withstand voltage $U_{imp}$	4 kV		
Rated insulation voltage $U_i$	690 V		
Max. back-up fuse	6A gG/gL		

#### Mechanical parameters

	AX52 11	AX52 20	AX52 02
Device width	9.5 mm		
Device height	98 mm		
Device depth	85.5 mm		
Mounting	left side		
Degree of protection	IP20		
Terminals	lift		
Terminal capacity	1 – 2.5 mm <sup>2</sup>		
Fastening torque of terminals	0.8 Nm		

#### Wiring diagram

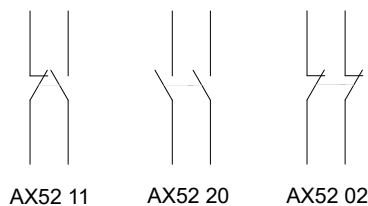

# Technical Data Ex9S32A accessories

## Accessories for motor protective circuit breakers Ex9S32A line

### Side-mounted auxiliary unit with status signalization AL5111

#### General parameters

For subsequent mounting

Side-mounted version

1 unit can be used with a motor protective circuit breaker

#### Electrical parameters

	<b>AL5111</b>
Contacts	1 NO + 1 NC
Tested according to	IEC/EN 60947-5-1
Rated operating voltage $U_e$	240 V AC, 415 V AC, 250 V DC, 400 V DC
Rated frequency	50/60 Hz
Rated thermal current $I_{th}$	5 A
Rated op. current $I_e$ , ut. cat. AC-15	1.5 A at 240 V, 1 A at 415 V
Rated op. current $I_e$ , ut. cat. DC-13	0.2 A at 250 V, 0.1 A at 400 V
Rated impulse withstand voltage $U_{imp}$	4 kV
Rated insulation voltage $U_i$	690 V
Max. back-up fuse	6A gG/gL

#### Mechanical parameters

	<b>AL5111</b>
Device width	9.5 mm
Device height	98 mm
Device depth	85.5 mm
Mounting	front
Degree of protection	IP20
Terminals	lift
Terminal capacity	1 – 2.5 mm <sup>2</sup>
Fastening torque of terminals	0.8 Nm

#### Wiring diagram

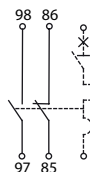

# Technical Data Ex9S32A accessories

## Accessories for motor protective circuit breakers Ex9S32A line

### Shunt trip releases SHT51

#### General parameters

For subsequent mounting

Side-mounted version, mounting from the right

1 unit can be used with a motor protective circuit breaker or UVT51 unit

#### Electrical parameters

	SHT51F	SHT51G	SHT51H
Tested according to	IEC/EN 60947-2		
Rated operating voltage $U_e$	110 – 115 V AC at 50 Hz 127 V AC at 60 Hz	220 – 240 V AC at 50 Hz	380 – 400 V AC at 50 Hz 440 V AC at 60 Hz
Oper. voltage tripping tolerance	70 – 110 % $U_e$		
Rated frequency $f$	50/60 Hz	50 Hz	50/60 Hz
Rated impulse withstand voltage $U_{imp}$	6 kV		
Rated insulation voltage $U_i$	690 V		

#### Mechanical parameters

	SHT51F	SHT51G	SHT51H
Device width	18.5 mm		
Device height	98 mm		
Device depth	85.5 mm		
Mounting	right side		
Degree of protection	IP20		
Terminals	lift		
Terminal capacity	1 – 2.5 mm <sup>2</sup>		
Fastening torque of terminals	1.7 Nm		

#### Wiring diagram

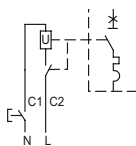



# Technical Data Ex9S32A accessories

## Accessories for motor protective circuit breakers Ex9S32A line

### Undervoltage releases UVT51

#### General parameters

For subsequent mounting

Side-mounted version, mounting from the right

1 unit can be used with a motor protective circuit breaker or SHT51 unit

#### Electrical parameters

	UVT51I	UVT51J	UVT51K
Tested according to	IEC/EN 60947-2		
Rated operating voltage $U_e$	110 – 115 V AC at 50 Hz 127 V AC at 60 Hz	220 – 240 V AC at 50 Hz	380 – 400 V AC at 50 Hz 440 V AC at 60 Hz
Rated frequency $f$	50/60 Hz	50 Hz	50/60 Hz
Rated impulse withstand voltage $U_{imp}$	6 kV		
Rated insulation voltage $U_i$	690 V		
Tripping time	200 ms		
Making threshold	85 % $U_e$		
Tripping threshold	70 – 35 % $U_e$		

#### Mechanical parameters

	UVT51I	UVT51J	UVT51K
Device width	18.5 mm		
Device height	98 mm		
Device depth	85.5 mm		
Mounting	right side		
Degree of protection	IP20		
Terminals	lift		
Terminal capacity	1 – 2.5 mm <sup>2</sup>		
Fastening torque of terminals	1.7 Nm		

#### Wiring diagram

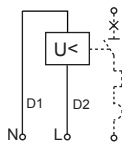

# Technical Data Ex9SN25B Accessories

## Accessories for motor protective circuit breakers Ex9SN25B

### Front-mounted auxiliary contact unit ASNB

#### General parameters

For subsequent mounting
Front-mounted version
1 unit can be used with a motor protective circuit breaker

#### Electrical parameters

	ASNB20	ASNB11
Contacts	2 NO	1 NO + 1 NC
Tested according to	EN 60947-5-1	
Rated operating voltage $U_e$	240V AC, 415V AC, 220V DC	
Rated frequency	50/60 Hz	
Rated thermal current $I_{th}$	2.5 A	
Rated op. current $I_e$ , ut. cat. AC-15	0.5 A at 240 V	
Rated op. current $I_e$ , ut. cat. DC-13	0.15 A at 60 V	
Rated impulse withstand voltage $U_{imp}$	2.5 kV	
Rated insulation voltage $U_i$	250 V	

#### Mechanical parameters

	ASNB20	ASNB11
Device width	45 mm	
Device height	9.5 mm	
Device depth	28.7 mm	
Mounting	front	
Degree of protection	IP20	
Terminals	lift	
Terminal capacity	1 – 2.5 mm <sup>2</sup>	
Fastening torque of terminals	0.8 Nm	

#### Wiring diagram

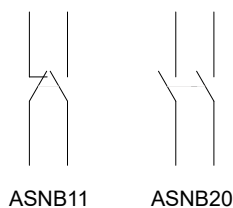

# Technical Data Ex9SN25B Accessories

## Accessories for motor protective circuit breakers Ex9SN25B

### Side-mounted auxiliary contact unit ASNA

#### General parameters

For subsequent mounting

Side-mounted version, mounting from the left

Up to 2 units can be used with a motor protective circuit breaker

#### Electrical parameters

	ASNA20	ASNA11
Contacts	2 NO	1 NO + 1 NC
Tested according to	EN 60947-5-1	
Rated operating voltage $U_e$	240 V AC, 415 V AC, 220 V DC	
Rated frequency $f$	50/60 Hz	
Rated thermal current $I_{th}$	6 A	
Rated op. current $I_e$ , ut. cat. AC-15	3.3 A at 240 V, 1.5 A at 415 V	
Rated op. current $I_e$ , ut. cat. DC-13	3 A at 60 V	
Rated impulse withstand voltage $U_{imp}$	4 kV	
Rated insulation voltage $U_i$	690 V	

#### Mechanical parameters

	ASNA20	ASNA11
Device width	9.5 mm	
Device height	91.3 mm	
Device depth	65.6 mm	
Mounting	left side	
Degree of protection	IP20	
Terminals	lift	
Terminal capacity	1 – 2.5 mm <sup>2</sup>	
Fastening torque of terminals	0.8 Nm	

#### Wiring diagram

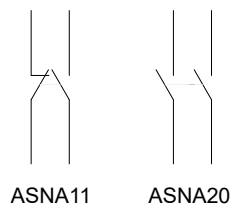

# Technical Data Ex9SN25B Accessories

## Accessories for motor protective circuit breakers Ex9SN25B

### Front-mounted auxiliary contact unit ASNF

#### General parameters

For subsequent mounting

Front-mounted version

1 unit can be used with a motor protective circuit breaker

#### Electrical parameters

	ASNF1001	ASNF0101	ASNF1010	ASNF0110
Contacts	1 NO (Fault) + 1 NC (Aux)	1 NC (Fault) + 1 NC (Aux)	1 NO (Fault) + 1 NO (Aux)	1 NC (Fault) + 1 NO (Aux)
Tested according to	EN 60947-5-1			
Rated operating voltage $U_e$	Fault: 240 V AC, Auxiliary: 690 V AC			
Rated frequency	50/60 Hz			
Rated thermal current $I_{th}$	Fault: 2.5 A, Auxiliary: 6 A			
Rated op. current $I_e$ , ut. cat. AC-14	Fault: 0.3 A at 240 V			
Rated op. current $I_e$ , ut. cat. DC-13	Fault: 0.15 A at 60 V			
Rated impulse withstand voltage $U_{imp}$	4 kV			
Rated insulation voltage $U_i$	690 V			

#### Mechanical parameters

	ASNF1001	ASNF0101	ASNF1010	ASNF0110
Device width	9.5 mm			
Device height	91.3 mm			
Device depth	65.5 mm			
Mounting	left side			
Degree of protection	IP20			
Terminals	lift			
Terminal capacity	1 – 2.5 mm <sup>2</sup>			
Fastening torque of terminals	0.8 Nm			

#### Wiring diagram

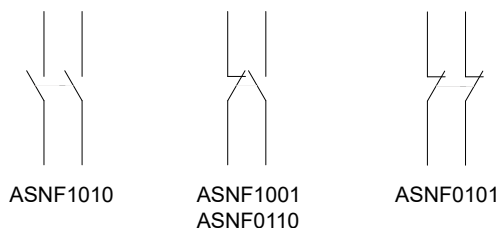

# Technical Data Ex9SN25B Accessories

## Accessories for motor protective circuit breakers Ex9SN25B

### Shunt trip releases ASNT

#### General parameters

For subsequent mounting

Side-mounted version, mounting from the right

1 unit can be used with a motor protective circuit breaker or ASNUV unit

#### Electrical parameters

	ASNTA	ASNTB	ASNTC
Tested according to	EN 60947-2		
Rated operating voltage $U_e$	110 – 115 V AC @ 50 Hz 127 V AC @ 60 Hz	220 – 240 V AC @ 50 Hz	380 – 400 V AC @ 50 Hz 440 V AC @ 60 Hz
Oper. voltage tripping tolerance	70 – 110 % $U_e$		
Rated frequency f	50/60 Hz		
Rated impulse withstand voltage $U_{imp}$	6 kV		
Rated insulation voltage $U_i$	690 V		

#### Mechanical parameters

	ASNTA	ASNTB	ASNTC
Device width	18.5 mm		
Device height	91.3 mm		
Device depth	65.5 mm		
Mounting	right side		
Degree of protection	IP20		
Terminals	lift		
Terminal capacity	1 – 2.5 mm <sup>2</sup>		
Fastening torque of terminals	0.8 Nm		

#### Wiring diagram

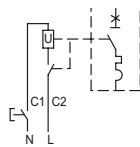

# Technical Data Ex9SN25B Accessories

## Accessories for motor protective circuit breakers Ex9SN25B

### Undervoltage releases ASNUV

#### General parameters

For subsequent mounting

Side-mounted version, mounting from the right

1 unit can be used with a motor protective circuit breaker or ASNT unit

#### Electrical parameters

	ASNUVA	ASNUVB	ASNUVC
Tested according to	EN 60947-2		
Rated operating voltage $U_e$	110 – 115 V AC @ 50 Hz 127 V AC @ 60 Hz	220 – 240 V AC @ 50 Hz	380 – 400 V AC @ 50 Hz 440 V AC @ 60 Hz
Oper. voltage tripping tolerance	35 – 70 % $U_e$		
Rated frequency f	50/60 Hz		
Rated impulse withstand voltage $U_{imp}$	6 kV		
Rated insulation voltage $U_i$	690 V		
Tripping time	200 ms		
Making threshold	85 – 110 % $U_e$		

#### Mechanical parameters

	ASNUVA	ASNUVB	ASNUVC
Device width	18.5 mm		
Device height	91.3 mm		
Device depth	65.5 mm		
Mounting	right side		
Degree of protection	IP20		
Terminals	lift		
Terminal capacity	1 – 2.5 mm <sup>2</sup>		
Fastening torque of terminals	0.8 Nm		

#### Wiring diagram

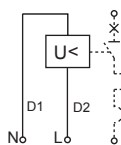

# Technical Data Ex9SN25B Accessories

## Accessories for motor protective circuit breakers Ex9SN25B

### Isolated boxes for surface mounting ASNE

#### General parameters

Plastic IP55 boxes for single Ex9SN25B device.

Insulated boxes for surface mounting.

#### Electrical parameters

	ASNEA	ASNEB
Tested according to		EN 62208
Rated operating voltage $U_e$		400 V AC
Rated frequency $f$		50 Hz

#### Mechanical parameters

	ASNEA	ASNEB
Device width		93 mm
Device height		148 mm
Device depth	94 mm	152 mm
Mounting		surface
Degree of protection		IP55

#### Dimensions

ANSEA

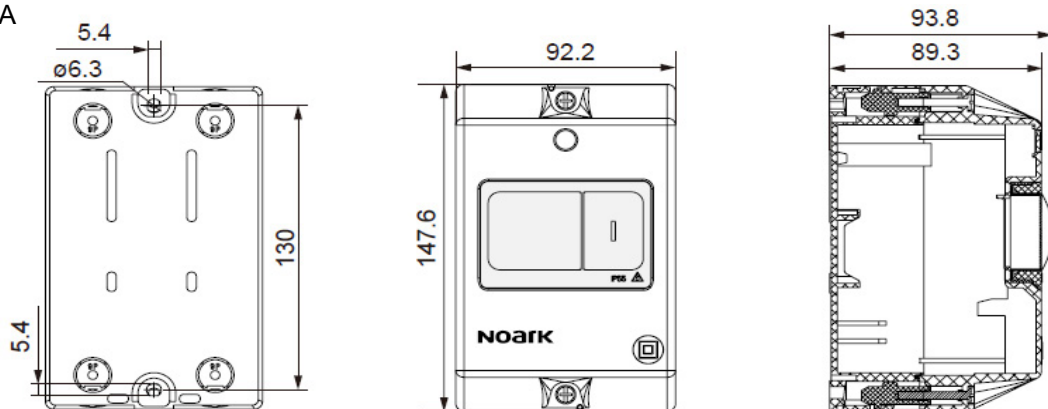

ANSEB

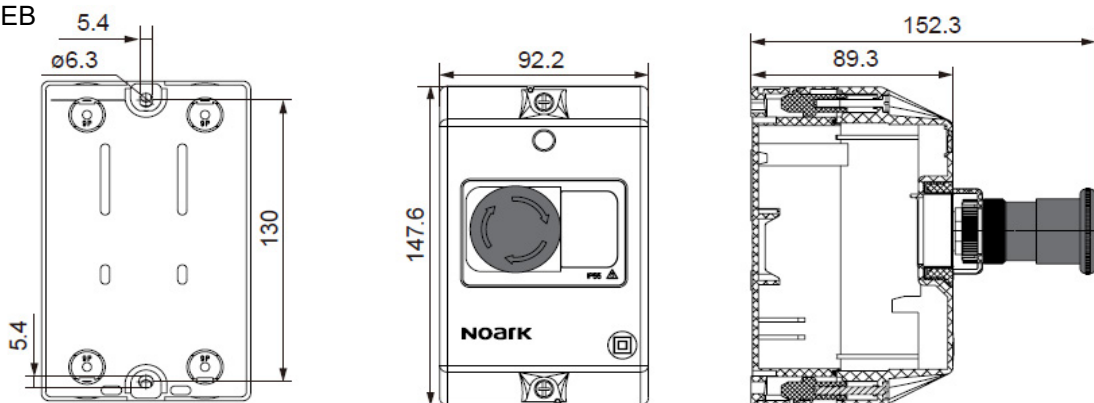

# Technical Data Ex9P1

## Panel mounted control devices

### General parameters

For various control desks, operator panels or machine control circuit parts applications as well as for control functions in power distribution boards

Various control head types with aluminium cover ring

Arbitrary combination of head, contact and LED units for various applications

### Electrical parameters - contact and LED units

	Ex9P1 1NO	Ex9P1 1NC	Ex9P1 LED
Tested according to	IEC / EN 60947-5-1		
Rated operational voltage $U_e$	120, 240, 415 V AC (AC-15) 125, 250 V DC (DC-13)		6, 12, 24, 36 V AC/DC 110 - 230 V AC
Rated operational current $I_e$ AC-15	6 A at 120 V AC 3 A at 240 V AC 1.9 A at 415 V AC		≤ 20 mA
DC-13	0.55 A at 125 V DC 0.27 A at 250 V DC		
Rated frequency f	50/60 Hz		
Rated impulse withstand voltage $U_{imp}$	4 kV	4 kV	—
Rated insulation voltage $U_i$	690 V	690 V	415 V
Utilization category	AC-15, DC-13		—
Electrical service life	1 000 000 operation cycles at AC 250 000 operation cycles at DC		> 30 000 hours
Power consumption	—	—	≤ 1.05 W
Max. short-circuit protection device	16 A gG		

### Mechanical parameters - contact and LED units

	Ex9P1 1NO	Ex9P1 1NC	Ex9P1 LED
Mounting	front mounting onto Ex9P1 B3 basement		
Mounting position	arbitrary		
Degree of protection	IP20		
Terminals	lift		
Terminal capacity	0.5 — 2.5 mm <sup>2</sup>		
Fastening torque of terminals	0.8 Nm		
Mechanical service life	3 000 000 operation cycles		—
Max. switching frequency	3 600 per hour		—
Ambient temperature	-5 — +40 °C		
Altitude	≤ 2000 m		
Relative humidity	≤ 90 % at 20°C		
Pollution degree	3		
Installation class	II		
Comparative tracking index CTI	175 V		
Shock IEC 60068-2-27	15 g (half sine 11 ms)		
Vibration IEC 60068-2-6	10-55 Hz, 0.5 mm		



# Technical Data Ex9P1

## Panel mounted control devices

### Wiring diagrams



### Mechanical parameters - control heads

	Ex9P1 F	Ex9P1 R	Ex9P1 D	Ex9P1 M
Mounting	into standard 22 mm panel cutout			
Mounting position	arbitrary			
Degree of protection	IP65 (mounted)			
Operation power	30 N	30 N	30 N	50 N
Operation torque	—	—	—	—
Mechanical service life	3 000 000 operation cycles	3 000 000 operation cycles	100 000 operation cycles	3 000 000 operation cycles
Max. switching frequency	3 600 per hour	3 600 per hour	2 400 per hour	3 600 per hour
Ambient temperature	-5 — +40 °C			
Altitude	≤ 2000 m			
Relative humidity	≤ 90 % at 20°C			
Pollution degree	3			
Installation class	II			

### Mechanical parameters - control heads

	Ex9P1 H	Ex9P1 S	Ex9P1 SK	Ex9P1 P
Mounting	into standard 22 mm panel cutout			
Mounting position	arbitrary			
Degree of protection	IP65 (mounted)			
Operation power	50 N	—	—	—
Operation torque	0.6 Nm	0.5 Nm	0.5 Nm	—
Mechanical service life	100 000 operation cycles	100 000 operation cycles	100 000 operation cycles	—
Max. switching frequency	1 200 per hour	1 200 per hour	1 200 per hour	—
Ambient temperature	-5 — +40 °C			
Altitude	≤ 2000 m			
Relative humidity	≤ 90 % at 20°C			
Pollution degree	3			
Installation class	II			

# Technical Data Ex9P1

## Panel mounted control devices

### Dimensions (complete devices)

Ex9P1 F.

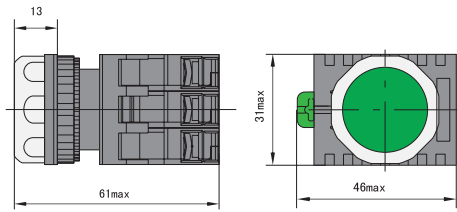

Ex9P1 D.

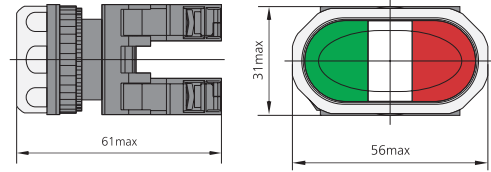

Ex9P1 R.

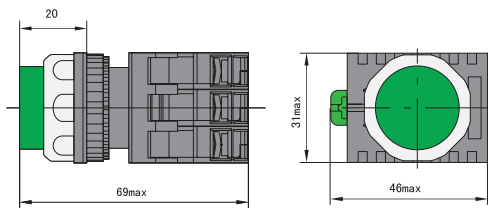

Ex9P1 P.

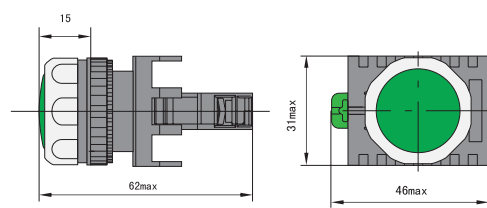

Ex9P1 M.

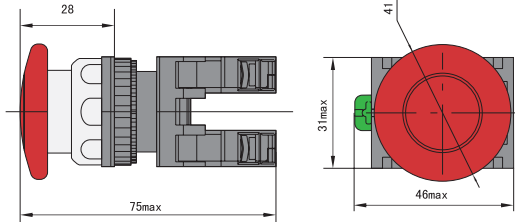

Ex9P1 S.

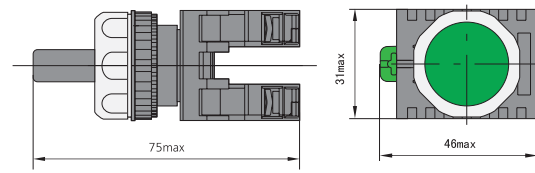

Ex9P1 H.

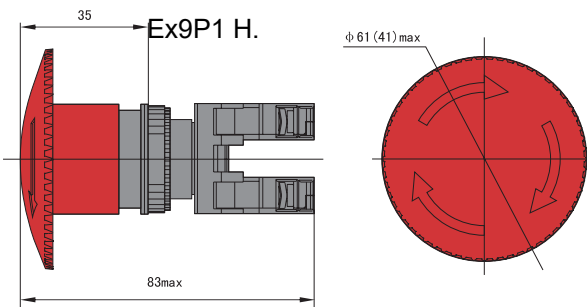

Ex9P1 S.K

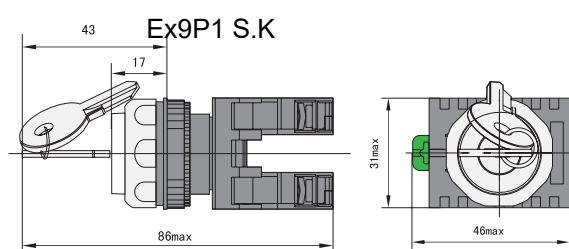

### Dimensions (holder for labels)

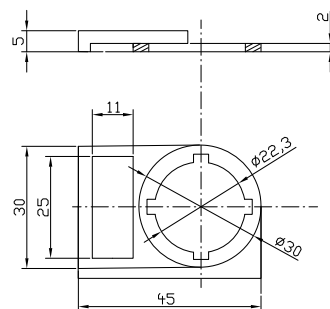

# Technical Data Ex9P1

## Panel mounted control devices

### Mounting dimensions

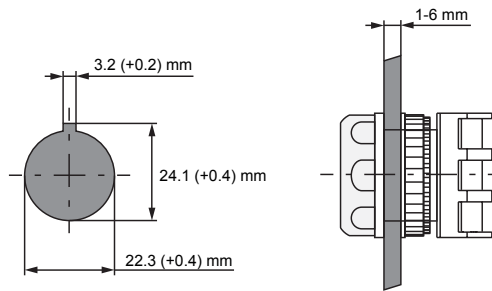

### Mounting principle

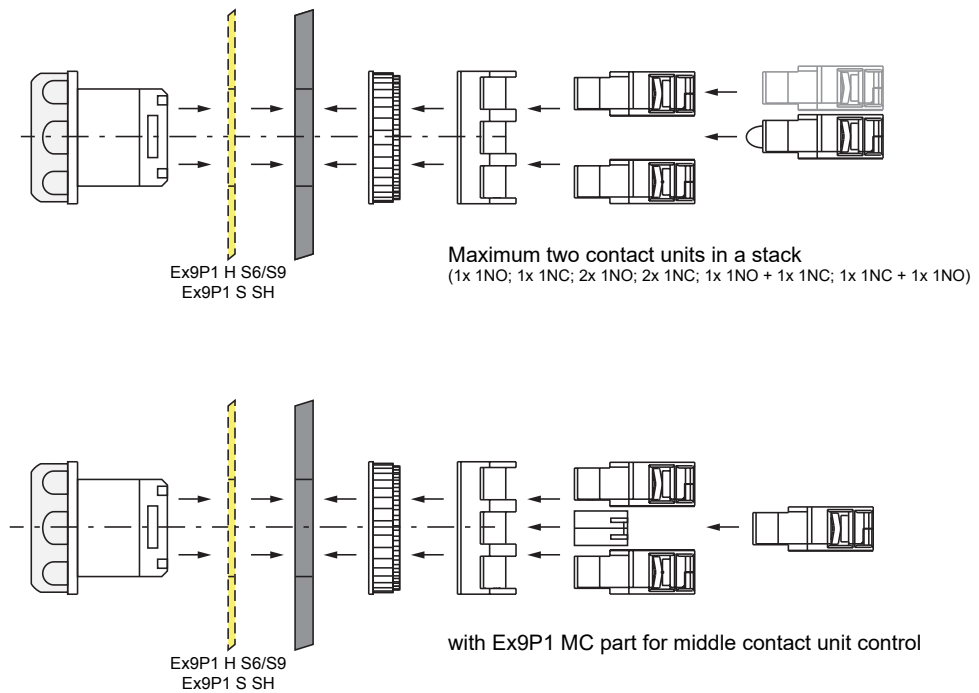

# Technical Data Ex9P2

## Panel mounted control devices

### General parameters

Various enclosure types up to 3 holes, yellow or grey colour

Relative humidity of the atmosphere could not exceed 50% when the highest temperature is +40°C

The average temperature during 24 hours could not exceed +35°C

Two grommets are in scope of delivery

### Electrical parameters

Tested according to	IEC / EN 60947-5-1
Rated operational voltage $U_e$	415V AC / 250V DC
Rated operational current $I_e$	≤ 20 mA
Conventional heating current $I_{th}$	10 A
Rated frequency $f$	50/60 Hz

### Mechanical parameters

Mounting	on surface
Degree of protection	IP65
Terminals	precuts + grommets
Terminal capacity	0.5 — 2.5 mm <sup>2</sup>
Fastening torque of terminals	0.8 — 1.2 Nm
Ambient temperature	-5 — +40 °C
Altitude	≤ 2000 m
Relative humidity	≤ 90 % at 20°C
Pollution degree	3
Installation class	II

# Technical Data Ex9P2

## Panel mounted control devices

### Dimensional drawings

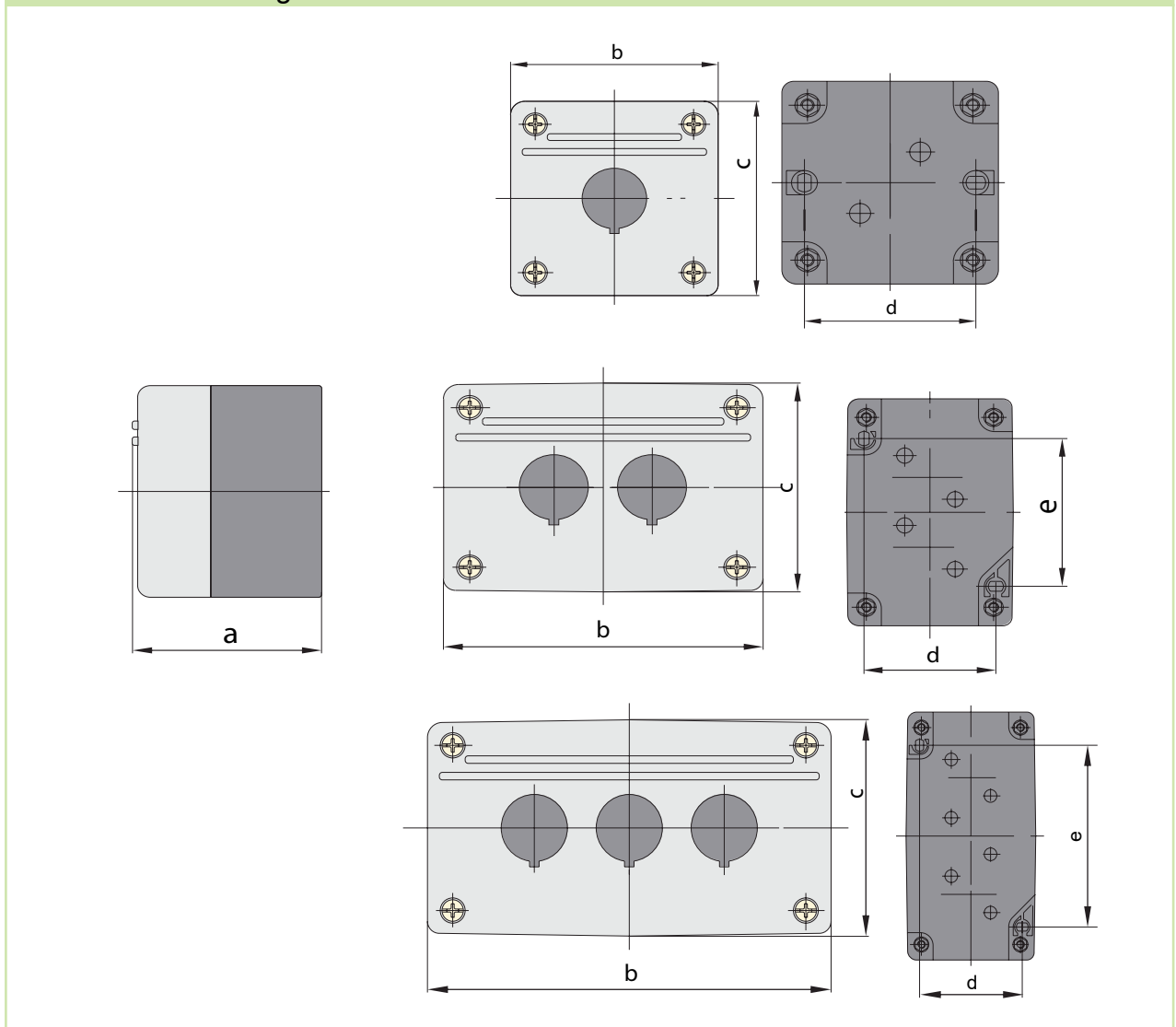

### Dimensions

Type	Dimensions [mm]				
	A	B	C	D	E
Ex9P2 FH 1 / Ex9P2 FH 1 y	61	75	75	57	57
Ex9P2 FH 2 / Ex9P2 FH 2 y	61	107	75	57	68
Ex9P2 FH 3 / Ex9P2 FH 3 y	61	139	75	57	100

# Technical Data Ex9IL

## Panel mounted signal lamps

### General parameters

Suitable for signaling of status of circuit in industrial applications, security system, etc.
Flat and arc shaped head cover types
Device height 51 or 53 mm (depends on type)
LED technology

### Electrical parameters

Tested according to	IEC / EN 60947-5-1
Rated operational voltage $U_e$	6, 12, 24, 36, 48 V AC/DC (resistance types) 110, 230, 400 V AC (capacitance types)
Rated operational current $I_e$	≤ 20 mA
Rated frequency f	50/60 Hz
Rated impulse withstand voltage $U_{imp}$	2.5 kV
Rated insulation voltage $U_i$	400 V
Electrical service life	≥ 30 000 hours
Power consumption	< 1 W
Brightness	≥ 60 cd/m <sup>2</sup>

### Mechanical parameters

Mounting	into standard 22 mm panel cutout
Mounting position	arbitrary
Degree of protection	IP65 (IP20 terminals)
Terminals	lift
Terminal capacity	0.5 — 2.5 mm <sup>2</sup>
Fastening torque of terminals	0.8 Nm
Ambient temperature	-5 — +40 °C
Altitude	≤ 2000 m
Relative humidity	≤ 90 % at 20°C
Pollution degree	3
Installation class	II
Overvoltage category	III
Comparative tracking index CTI	175 V

# Technical Data Ex9IL

## Panel mounted signal lamps

### Dimensions

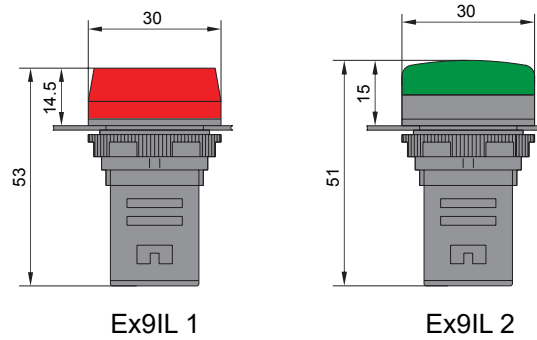

### Mounting

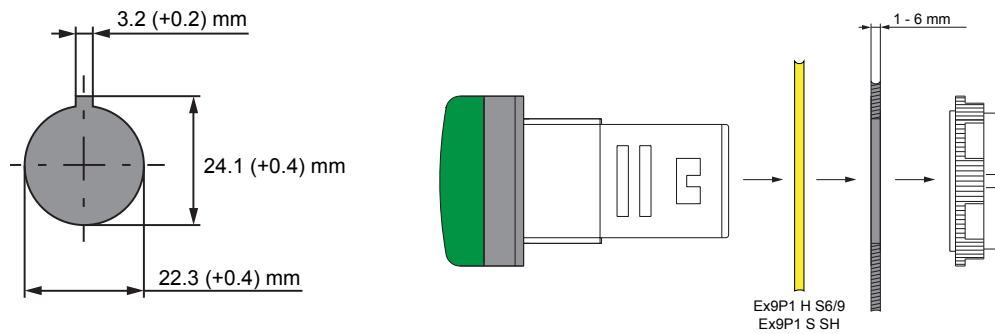

### Wiring diagram



### Dimensions (holder for labels)

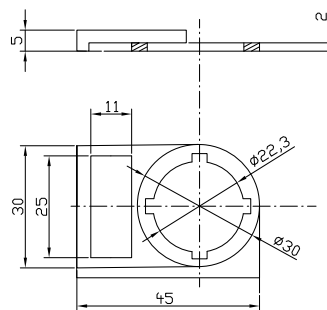

# Technical Data Ex9PB

## Panel mounted buzzers

### General parameters

Suitable mainly for industrial applications, security system, etc.
Interrupted and continuous, illuminated and non-illuminated versions
Easy mounting into standard 22 mm panel cutout
LED lighting technology

### Electrical parameters

Tested according to	IEC / EN 60947-5-1
Rated operational voltage $U_e$	24, 36, 48, 110 V AC/DC 230, 400 V AC
Rated operational current $I_e$	$\leq 20$ mA
Rated frequency $f$	50/60 Hz
Rated impulse withstand voltage $U_{imp}$	2.5 kV
Rated insulation voltage $U_i$	400 V
Electrical service life	$\geq 30\,000$ hours
Tone frequency	2300 Hz
Tone length (interrupted versions)	0.5 s, period 1 s
Sound loudness	75 — 105 dB
Power consumption	$< 1$ W
LED brightness	$\geq 20$ cd/m <sup>2</sup>

### Mechanical parameters

Mounting	into standard 22 mm panel cutout
Mounting position	arbitrary
Degree of protection	IP30 (IP20 terminals)
Terminals	lift
Terminal capacity	0.5 — 2.5 mm <sup>2</sup>
Fastening torque of terminals	0.8 Nm
Ambient temperature	-5 — +40 °C
Altitude	$\leq 2000$ m
Relative humidity	$\leq 90$ % at 20°C
Pollution degree	3
Installation class	II
Overvoltage category	III



# Technical Data Ex9PB

## Panel mounted buzzers

### Dimensions

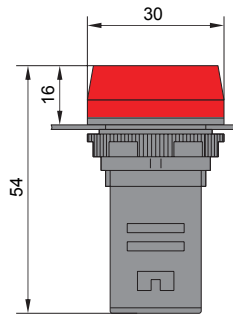

### Mounting

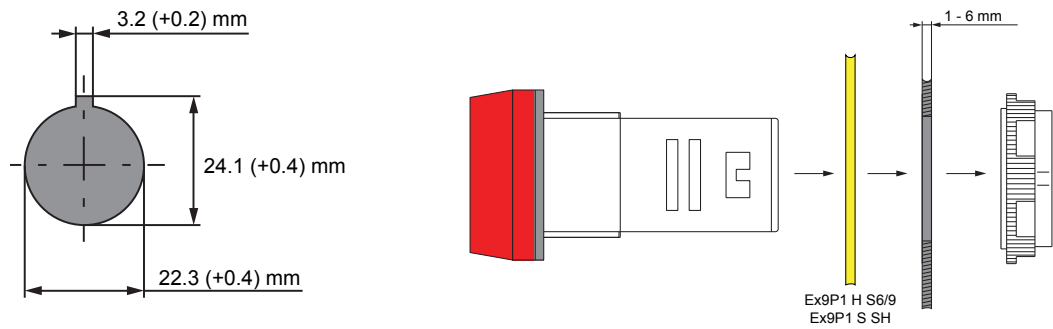

### Wiring diagram

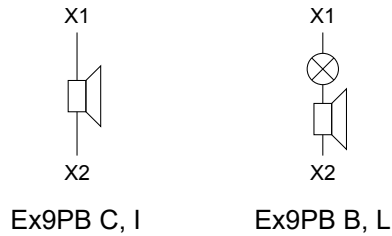

### Dimensions (holder for labels)

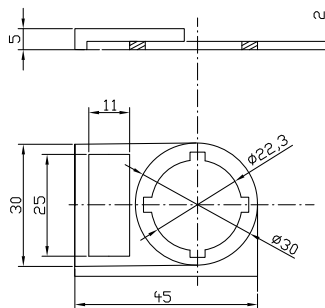

# Index

Type	Ordering info	Technical data	Type	Ordering info	Technical data
AD	119		Ex9CR12	37	166
AL51	110	229	Ex9CR18	38	166
ASNA	114	233	Ex9CR25	39	170
ASNB	114	232	Ex9CR32	40	170
ASNE	115	237	Ex9CR38	41	170
ASNF	114	234	Ex9CR40	42	174
ASNT	115	235	Ex9CR50	43	174
ASNUV	115	236	Ex9CR65	44	174
AX	103	216	Ex9CR80	45	178
AX41	103	218	Ex9CS06	7	147
AX42	104	218	Ex9CS09	9	147
AX43	104	220	Ex9CS12	11	147
AX44	105	225	Ex9CSR06	15	150
AX51	110	227	Ex9CSR09	17	150
AX52	110	228	Ex9CSR12	19	150
CC51	111	194	Ex9IL 1	138	241
CCU	106	224	Ex9IL 1C	138	241
DRA51	111		Ex9IL 1R	138	241
ECC	107		Ex9IL 2	139	241
Ex9C09	24	154	Ex9IL 2C	139	241
Ex9C100	32	163	Ex9IL 2R	139	241
Ex9C115	50	182	Ex9JM1L05	73	200
Ex9C12	25	154	Ex9JM2DZ-05	73	200
Ex9C150	50	182	Ex9JM2DZ-10	72	200
Ex9C18	26	154	Ex9JM2L 10	72	200
Ex9C185	51	182	Ex9JM4DZ-03	74	200
Ex9C225	52	186	Ex9JM4L03	74	200
Ex9C25	27	157	Ex9JP	68	197
Ex9C265	52	186	Ex9P1 1NC	134	239
Ex9C300	53	186	Ex9P1 1NO	134	239
Ex9C32	28	157	Ex9P1 B3	133	239
Ex9C38	29	157	Ex9P1 D	133	239
Ex9C40	30	160	Ex9P1 F	125	239
Ex9C400	54	190	Ex9P1 H	127	239
Ex9C50	30	160	Ex9P1 H r	127	239
Ex9C500	54	190	Ex9P1 LED	134	239
Ex9C65	31	160	Ex9P1 M	126	239
Ex9C80	32	163	Ex9P1 M6	126	239
Ex9CC100	63	194	Ex9P1 MC	133	239
Ex9CC25	58	194	Ex9P1 PI	133	239
Ex9CC38	59	194	Ex9P1 R	125	239
Ex9CC50	60	194	Ex9P1 S	128	239
Ex9CC65	61	194	Ex9P1 S S	135	239
Ex9CC80	62	194	Ex9P1 S SH	135	239
Ex9CR09	36	166	Ex9P1 S3	129	239
Ex9CR100	46	178	Ex9P1 S3K	132	239

# Index

Type	Ordering info	Technical data	Type	Ordering info	Technical data
Ex9P1 SK	131	239			
Ex9P1 SMS3	130	239			
Ex9P1 SMS3K	132	239			
Ex9P1 SS	128	239			
Ex9P1 SS3	129	239			
Ex9P1 SS3K	132	239			
Ex9P1 SSM3	130	239			
Ex9P1H 6	127	239			
Ex9P1H 6	127	239			
Ex9P2 FH 1	136	239			
Ex9P2 FH 2	136	239			
Ex9P2 FH 2	136	239			
Ex9P2 FH 3	136	239			
Ex9PB C k	143	243			
Ex9PB C r	143	243			
Ex9PB I k	142	243			
Ex9PB I r	142	243			
Ex9PB L r	143	243			
Ex9R100	91	210			
Ex9R12	89	210			
Ex9R185	95	213			
Ex9R38	90	210			
Ex9R500	95	213			
Ex9S32A	79	202			
Ex9SN25B	83	206			
MIT	105				
PCL	105				
SHT51	110	230			
TDD	106	222			
UVT51	111	231			

# Catalogues and assortment overview



## INSTALLATION DEVICES

- Miniature Circuit Breakers
- Fuse Holders and Disconnectors
- Isolators
- Residual Current Devices
- Energy Meters
- Motor Protective Circuit Breakers
- Accessories for Installation Devices
- Surge Protection Device
- Installation Relays and Contactors
- Switches and Signal Lamps
- Timers and Light Intensity Switches
- Other Installation Devices



## MOULDED CASE CIRCUIT BREAKERS

- AC Thermomagnetic Moulded Case Circuit Breakers Ex9M
- AC Electronic Moulded Case Circuit Breakers Ex9M SU20L (DIP switches version)
- AC Electronic Moulded Case Circuit Breakers Ex9M SU20S (LCD version)
- AC MCCB Switch Disconnectors Ex9MSD
- DC Thermomagnetic Moulded Case Circuit Breakers Ex9M
- DC MCCB Switch Disconnectors Ex9MSD
- Accessories for MCCBs



## INDUSTRIAL DEVICES

- Contactors and Relays
- Motor Protective Circuit Breakers
- Overload Relays
- Accessories
- Panel Mounted Devices

# Catalogues and assortment overview



## CONSUMER UNITS

- Plastic Consumer Units
- Plastic Consumer Units with Sheet Steel Door
- Plastic Consumer Units for Outdoor Use
- Metal Flat Enclosures
- Metal Enclosures with Mounting Plates
- Interconnection Systems



## PHOTOVOLTAIC COMPONENTS AND SOLUTIONS

- Miniature Circuit Breakers
- Fuse Disconnectors
- Isolators
- Surge Protection Devices
- Moulded Case Circuit Breakers and Switch Disconnectors
- EV chargers



## AIR CIRCUIT BREAKERS

- Digital Tripping Units
- Air Circuit Breakers
- Air Switch Disconnectors
- Accessories

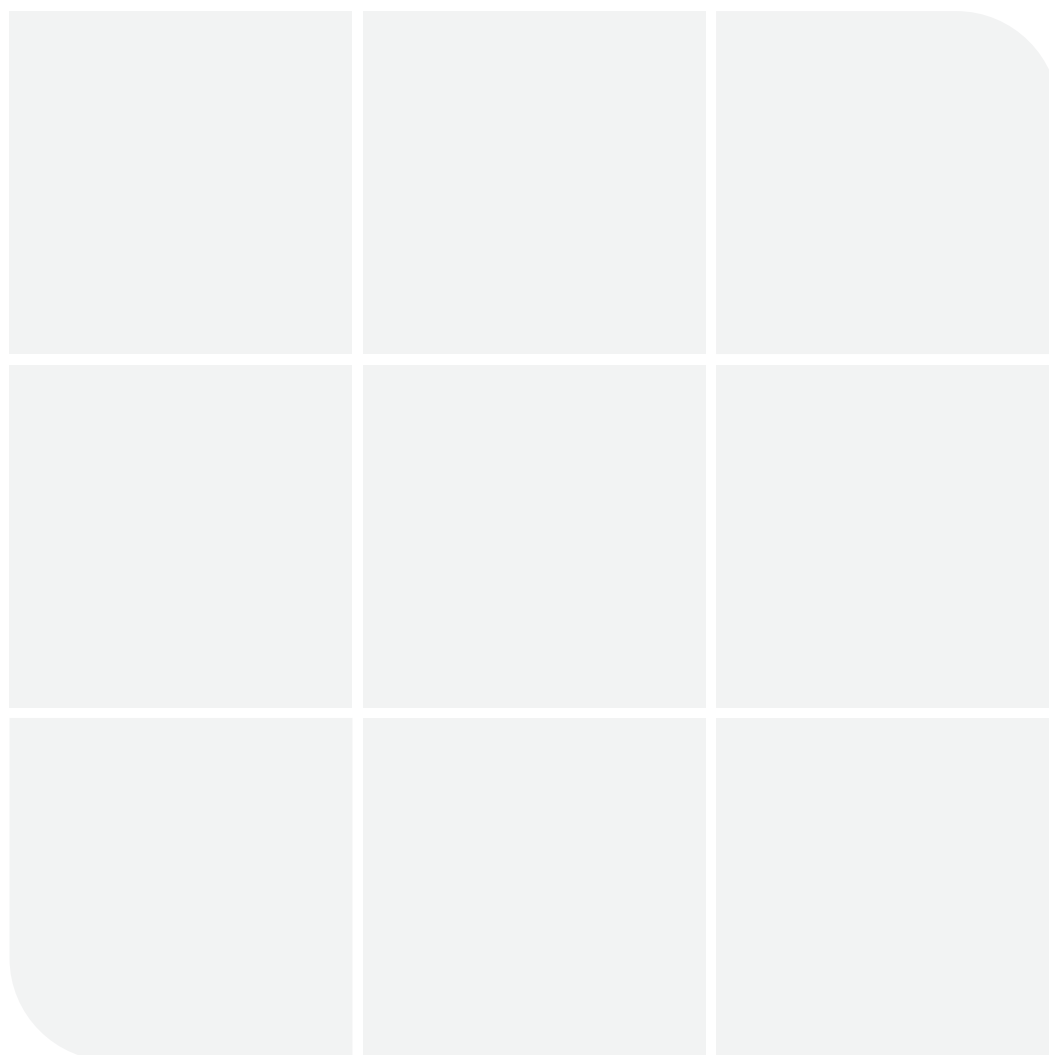

**NOARK Electric Europe s.r.o.**

Sezemická 2757/2, 193 00 Prague 9, Czech Republic

Phone: +420 226 203 120

E-mail: [Europe@noark-electric.com](mailto:Europe@noark-electric.com)

[www.noark-electric.eu](http://www.noark-electric.eu)

# NOARK

