



*....dichtet sofort*

**KATALOG 2019**

Vrbovec 321, 671 24 Vrbovec, Tschechische Republik

**Email:** [info@aditeg.cz](mailto:info@aditeg.cz)

**Telefon / fax:** +420 515 320 023 / +420 515 320 024

**[www.aditeg.cz](http://www.aditeg.cz)**

# INHALTSVERZEICHNIS

## ÜBER UNS

S. 3

## EIGENSCHAFTEN DER ELASTOMERE

S. 8

## PLATTEN

S. 11

### GUMMIPLATTEN

- SBR-Gummiplatten .....	S. 12
- NBR-Gummiplatten .....	S. 14
- EPDM-Gummiplatten .....	S. 16
- CR-Gummiplatten .....	S. 17
- FPM-Gummiplatten .....	S. 19
- SILIKON-Gummiplatten .....	S. 19
- NR-Gummiplatten .....	S. 19
- PU-Gummiplatten .....	S. 19
- MIKROPORÖSE MATERIALIEN .....	S. 20
- REGRANULAT .....	S. 29

### BODENPLATTEN

- GUMMI .....	S. 45
- PVC .....	S. 47
- KUNSTSTOFF .....	S. 48

### GUMMIMATTEN

- Tür-Gummimatten .....	S. 52
- Gummimatten .....	S. 55
- rutschfeste PVC-Matten .....	S. 57
- rutschfeste Gummi-Badematten .....	S. 58

<b>PFERDESTALLMATTEN .....</b>	<b>S. 59</b>
--------------------------------	--------------

<b>ASBESTFREIE DICHTUNGSPLETTEN ADISEAL .....</b>	<b>S. 61</b>
---	--------------

## FÖRDERBÄNDER

S. 62

### PTFE-PLATTEN / PTFE-STÄBE / PTFE-BÄNDER

S. 64

- Platten .....	S. 64
- Stäbe .....	S. 64
- Bänder .....	S. 65

## SILENTBLÖCKE

S. 66

- TYP A .....	S. 67
- TYP B .....	S. 68
- TYP C .....	S. 69
- TYP D .....	S. 70
- TYP E .....	S. 71

## RUNDSCHNÜRE

S. 72

- Silikon-Rundschnur .....	S. 73
- FPM-Rundschnur .....	S. 73
- EPDM-Rundschnur .....	S. 73
- NBR-Rundschnur .....	S. 74
- EPDM-mikroporöse Rundschnur .....	S. 74

## SCHLÄUCHE

S. 75

- Gartenschläuche .....	S. 76
- Gewebesläuche .....	S. 77
- Saugschläuche mit PVC-Spirale .....	S. 78
- Schläuche mit Stahlspirale .....	S. 79
- einmantelige Schläuche .....	S. 80
- Silikonschläuche .....	S. 82

## SCHARSCHEIDEN

S. 83

## PVC-STREIFENVORHÄNGE

S. 84

## WAGENHEBER-GUMMIAUFLAGEN

S. 85

## HYDRAULIKDICHTUNGEN

S. 86

- Ölabbreifringe .....	S. 87
- Kolbenstangendichtungen .....	S. 88
- Führungsringe .....	S. 89
- Kolbendichtungen .....	S. 90
- Statische Dichtungen .....	S. 91
- Wellendichtungen .....	S. 92
- Stützringe .....	S. 93

## WASSERLEITUNGSDICHTUNGEN

S. 94

## GESTANZTE PRODUKTE

S. 96

## GEPRESSTE PRODUKTE

S. 97

## O-RINGE

S. 98

## PROFILE

S. 99

- Silikon Quadrat- und Rechteck-Profile .....	S. 100
- Auflageprofile .....	S. 102
- P-Profile .....	S. 103
- Fassadenprofil .....	S. 109
- Fugenabdeck- und T-Profile .....	S. 113
- H-Profile .....	S. 117
- D-Profile .....	S. 119
- Kantenschutzprofile .....	S. 128
- Keil- und Steckprofile .....	S. 132
- Klemmprofile .....	S. 134
- Kronenprofile .....	S. 137
- Rolltor und- Fingerschutzprofile .....	S. 139
- Rundschnüre .....	S. 143
- C-Profile .....	S. 144
- Schlauchprofile .....	S. 146
- Spezial-U-Profile .....	S. 147
- U-Profile .....	S. 148
- Vierkantprofile .....	S. 165
- L-Profile .....	S. 168
- Zargenprofile .....	S. 172

# ADITEG s.r.o.

RUBBIPRODUKTE

*....dichtet sofort*



[www.aditeg.cz](http://www.aditeg.cz)

Unsere Firma Aditeg s.r.o. wurde im Jahre 2003 gegründet und hat in ihrer Startphase ausschließlich über Bürokomplexe verfügt. Dank unserer erfolgreichen Etablierung auf dem Markt und dem damit einhergehenden rasanten Wachstum zogen wir nach 3 Jahren nach Vrbovec, wo ein Herstellungs-, Lager- und Distributionszentrum errichtet wurde. Aufgrund der Absatzsteigerung wurden unsere Räumlichkeiten allerdings zu klein. Dies zwang uns zur Errichtung eines neuen Produktionszentrums und zur erneuten Umsiedlung. 2017 erweiterten wir aus Kapazitätsgründen wieder unsere Herstellungs- und Lagerräumlichkeiten, die es uns ermöglichten, schrittweise neue Maschinen mit modernsten Herstellungstechnologien anschaffen zu können.

Infolgedessen konnten wir unsere Produktionsmöglichkeiten erweitern.

### **Unsere Maschinenausstattung:**

- 6 CNC\_Plotter
- 2 CNC Tischfräsmaschinen
- 1 CNC Drehmaschine
- 3 automatische Brückenpressen
- 2 kleine übliche Stanzpressen
- 1 Kiss-Cut
- 2 Streifenschneidemaschinen
- 1 Laminiermaschine
- 1 Spaltmaschine Bäume
- 2 Einspritzpressen
- 1 Profilextruder

Dies ermöglicht es uns, individuelle Aufträge zu bearbeiten und Ihnen günstige Preise anzubieten.

### **In unserem Sortiment finden Sie eine Gummiproduktpalette von:**

- Platten
- Silentblöcken
- Profilen
- O-Ringen
- Flachringen
- Formteilen
- gestanzten Produkten, usw.

### **Unsere Produkte können Sie folgendermaßen auswählen:**

- IM PRODUKTKATALOG - Seine übersichtliche Struktur ermöglicht Ihnen eine komfortable Auswahl.
- IM E-SHOP – der ein Teil unserer Webseite ([www.aditeg.cz](http://www.aditeg.cz)) ist.

### **Zu den Vorteilen unserer Firma Aditeg s.r.o. zählt eine breite Palette von lagernden Produkten, sehr kurze Liefertermine, sowie rasche Auftragsabwicklung.**

Zu unseren zufriedenen Kundinnen zählen KlientInnen auf dem tschechischen Markt sowie aus aller Welt. Wir verfügen über eine Zertifizierung nach ISO 9001:2016 und nach ISO 14001:2016 und dem anerkannten Qualitätssiegel. Unsere Produkte entsprechen der Maß- und Qualitätstoleranz nach den zulässigen Normen. Wir legen großen Wert auf ein ausgeglichenes Verhältnis zwischen der Qualität und dem Preis, sowie auf einen individuellen Zugang zu unseren Kundinnen, die Anpassung der Produktion nach Ihrem Bedarf und auf fristgemäße Lieferungen. Dank diesen Vorteilen wächst unser zufriedener Kundenstamm.

**Sie werden die familiäre Atmosphäre in unserer Firma und die Bemühungen, stets unser Bestes zu geben, bestimmt zu schätzen wissen. Wir hoffen, dass wir Ihr Interesse an unseren Produkten, die sowohl für Sie, als auch für Ihre KundInnen nützlich sind, geweckt haben.**

## WIR SIND DIE NUMMER 1 IN DER HERSTELLUNG VON DICHTUNGEN, TECHNISCHEM GUMMI UND WEITEREN GUMMIPRODUKTEN

WARUM SICH DIE ZUSAMMENARBEIT MIT UNS FÜR SIE LOHNT?

- ein breites Angebot an lagernden Dichtungen
- sehr kurze Liefertermine
- Auftragsanfertigungen von technischem Gummi
- Zertifizierung nach ISO 9001:2016
- Zertifizierung nach ISO 14001:2016
- rechtzeitige Lieferung



Alle im Katalog angegebenen Preise verstehen sich in CZK und zzgl. der gesetzlichen MwSt. Diese Preise sind mit der Ausgabe dieses Katalogs bis zum Erscheinen eines neuen Katalogs gültig. Die Fotos dienen zur illustrativen Darstellung. Druckfehler und alle Rechte sind vorbehalten.



ÜBER UNS







ÜBER UNS

## NATURKAUTSCHUK(NR)

- + sehr gute Elastizität und mechanische Eigenschaften (Reißfestigkeit, Dehnung, Abriebfestigkeit)
- + bei Belastung – kleine dauerhafte Verformung, hohe Beständigkeit gegenüber wechselnder Biegung
- schlechte Beständigkeit gegen Öl, Ozon, Witterung und Hitze
- brennbar

## STYROL-BUTADIEN-KAUTSCHUK (SBR)

- + erträgt kurzzeitig höhere Temperaturen als NR
- ähnlich wie bei NR, allerdings mit geringerer Elastizität, dadurch ergibt sich eine niedrige Rückprallelastizität und somit auch eine große Temperaturerhöhung
- bei einer dynamischen Beständigkeit resultiert eine schlechte Kerbfestigkeit, brennbar

## BUTYL-KAUTSCHUK (IIR)

- + gute Beständigkeit gegenüber Ozon und Witterung, sehr niedrige Gas- und Luftdurchlässigkeit
- + gute Elektroisolationseigenschaften
- + gutes Verhalten bei niedrigen Temperaturen, höchst effektives Dämpfungsmaterial für aperiodische Schwingungen
- + gute Beständigkeit gegen Heißwasser und Chemikalien
- niedrige Rückprallelastizität, geringe Beständigkeit gegen Öle und Fette
- brennbar

## ETHYLEN-PROPYLEN-DIEN-KAUTSCHUK (EPDM)

- + ausgezeichnete Beständigkeit gegen Alterung, Witterung, Ozon, Chemikalien, Heißwasser, Dampf und polare Lösungsmittel, z.B. Aceton, Methanol oder Ester
- + ausgezeichnete Elektroisolationseigenschaften
- + sehr gute Hitzebeständigkeit, sowie gutes Verhalten bei niedrigen Temperaturen
- geringe Beständigkeit gegenüber aliphatischen und aromatischen Kohlenwasserstoffen (Mineralöle, Benzin, Treibstoffe)
- brennbar

## NITRIL-KAUTSCHUK (NBR)

- + ausgezeichnete Öl- und Benzinbeständigkeit, gute mechanische Eigenschaften, geringe bleibende Verformung unter Druck
- + bessere Hitzebeständigkeit als SBR, geringe Gasdurchlässigkeit
- schlechte Beständigkeit gegen Witterung, mit toxischen Rauchgasen brennbar
- schlechte Beständigkeit gegenüber aromatischen und polaren Lösemitteln.

## HYDRIERTER NITRILKAUTSCHUK (HNBR)

- + sehr gute mechanische Eigenschaften, sehr gute Abriebfestigkeit und Hitzebeständigkeit
- + sehr gute Beständigkeit gegenüber Alterung, Ozon und Witterung
- + ausgezeichnete Öl-, Fett- und Kraftstoffbeständigkeit, sehr gute Beständigkeit gegen Heißwasser und Dampf
- geringe Beständigkeit gegenüber aromatischen und polaren Lösemitteln
- schlechte Elektroisolationseigenschaften, mit toxischen Rauchgasen brennbar

## CHLOROPREN-KAUTSCHUK (CR)

- + gute Beständigkeit gegen Hitze, Alterung, Ozon und Witterung
- + mäßige Beständigkeit gegen Öle, gute mechanische Eigenschaften und Elastizität, hohe Beständigkeit gegenüber wechselnder Biegung
- + brennt nicht in eigener Flamme
- bei einzelnen CR-Typen kommt es zu kleineren oder größeren Selbstverhärtungen
- schlechte Beständigkeit gegen Öle und Treibstoffe

## CHLOR-SULFAT-POLYETHYLEN (CSM)

- + gute Beständigkeit gegen Alterung, Ozon und Witterung, sehr niedrige Luftdurchlässigkeit
- + gute Beständigkeit gegenüber Chemikalien (vor allem bei stark oxidierten)
- schlechte Beständigkeit gegen niedrige Temperaturen
- schlechte Kraftstoffbeständigkeit

## ACRYLAT-AUTSCHUK (ACM)

- + gute Beständigkeit gegenüber Alterung, Ozon und Witterung
- + ausgezeichnete Öl-, Fett- und Kraftstoffbeständigkeit
- + sehr hohe Hitzebeständigkeit
- schlechte Beständigkeit gegenüber Chemikalien, Hydrolyse und niedrigen Temperaturen
- schlechte mechanische Eigenschaften und niedrige Elastizität

## POLYURETHAN-KAUTSCHUK (PU)

- + gute Beständigkeit gegen Alterung, Ozon und Witterung
- + sehr gute Abriebfestigkeit, Kerbfestigkeit und Zugfestigkeit
- + niedrige Gasdurchlässigkeit
- sehr wasserempfindlich, vor allem bei Wassertemperaturen über 50°C
- dauerhafte Verformung bei höheren Temperaturen, brennbar

## SILIKON-KAUTSCHUK (Q)

- + sehr gute Beständigkeit gegen hohe und niedrige Temperaturen
- + ausgezeichnete Beständigkeit gegen Alterung, Ozon und Witterung
- + gute Elektroisolationseigenschaften, mechanische Werte bleiben über einen breiten Temperaturbereich konstant
- + physiologisch unbedenklich
- mäßige mechanische Eigenschaften
- mäßige Ölbeständigkeit
- empfindlich bei Einwirkung von Heißwasser und Dampf
- schlechte Kraftstoffbeständigkeit

## FLUOR-SILIKON-KAUTSCHUK(MFQ)

- + sehr gute Beständigkeit gegen hohe und niedrige Temperaturen
- + ausgezeichnete Beständigkeit gegen Alterung, Ozon und Witterung
- + gute Elektroisolationseigenschaften, mechanische Werte bleiben über einen breiten Temperaturbereich konstant
- + gute Ölbeständigkeit und Kraftstoffbeständigkeit
- mäßige mechanische Eigenschaften
- sehr hoher Preis

## FLUOR-KAUTSCHUK (FPM)

- + ausgezeichnete Beständigkeit gegen Hitze, Alterung, Ozon und Witterung
- + sehr gute Beständigkeit gegen Chemikalien, niedrige Gasdurchlässigkeit
- + brennt nicht in eigener Flamme
- empfindlich bei Einwirkung von Heißwasser, Dampf, organischen Säuren und polaren Lösungsmitteln
- schlechte Kälteflexibilität

## POLYTETRAFLUORETHYLEN - TEFLON (PTFE)

- + Chemikalienbeständigkeit
- + Beständigkeit gegen Alterung und hohen Temperaturen
- + niedrige Saugfähigkeit und Lösungsmittelbeständigkeit
- Zersetzung bei höherer Dosis radioaktiver Strahlungen
- gute Gleiteigenschaften

Gummiplatten setzen sich in vielen Industriebereichen, wo man Isolier-, Schutz- und Dämpfeigenschaften nutzen kann, durch. Je nach Herstellungstechnologie, gewählten Material und Oberflächenstruktur unterscheiden wir zwischen

## **GUMMIPLATTEN, MIKROPORÖSE GUMMIPLATTEN und BODENPLATTEN**

Ihre Nutzungsweise unterscheidet sich nach Eigenschaften wie sehr hohe Formbarkeit, Elastizität, Undurchlässigkeit, Unsaugfähigkeit und mechanische Beständigkeit.

Wir bieten die Platten standardmäßig in **ROLLEN oder PLATTEN**, nach dem von Ihnen gewünschten Format, an. Die Standardmaße von 1200x10000mm ist auf Lager, sowie die Breite von 1400/1500/1800/2000mm, Preise und Lieferbarkeit erfolgen auf Anfrage.

Ihre Nutzung ist sowohl für den Außen-, als auch für den Innenbereich geeignet.

Wenn Sie uns den Nutzungszweck der Platten mitteilen, können wir Ihnen ein geeignetes Material für den gewünschten Anwendungsbereich empfehlen.

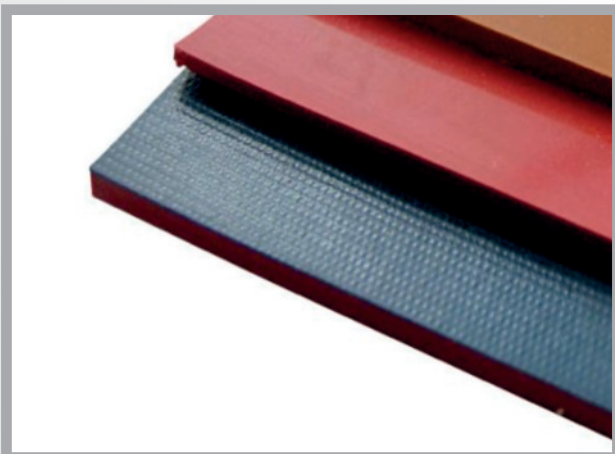

# GUMMIPLATTEN

SBR-GUMMIPLATTEN



Gummiplatten werden in vielen Bereichen als Dichtungs- und Dämpfungselemente eingesetzt oder dienen als Halbprodukt zur Herstellung von verschiedenen Dichtungs- und Dämpfungsteilen, usw.

Sie werden entweder mit einer glatten oder einer strukturierten Oberfläche hergestellt. Innen können sie mit einer Textileinlage verstärkt werden. Standardmäßig werden sie in Rollen oder Platten mit einer Dicke von 0,1 – 50mm geliefert.

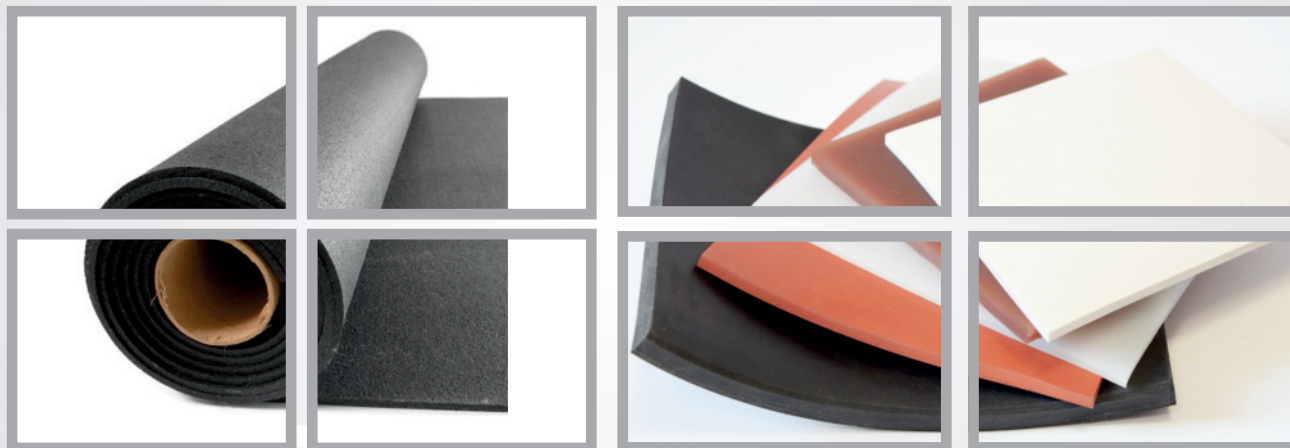

Nach Anfrage werden auch nicht angegebene Stärken angeboten. Die unterschiedlichen Eigenschaften von Gummiplatten, wie mechanische Beständigkeit, Ölbeständigkeit, Säurebeständigkeit und spezifisches Gewicht hängen von den Mischungsverhältnissen ab. Sie lassen sich üblicherweise durch Schneiden oder Ausstanzen formen.

SBR 65 +/- 10 Sh., 2-3 MPa		
Stärke	Preis	
	1 - 11,99m <sup>2</sup>	12 - 119,99m <sup>2</sup>
1mm	90,90	50,70
1,5mm	145,20	79,20
2mm	185,90	101,30
2,5mm	241,90	132,00
3mm	278,40	151,80
3,5mm	338,40	184,50
4mm	371,50	191,30
5mm	464,20	239,00
6mm	557,10	286,80
8mm	742,70	382,40
10mm	942,10	485,10
12mm	958,40	493,50
15mm	1.197,60	616,70
20mm	1.595,90	821,80
25mm	1.995,50	1.027,60
30mm	2.393,80	1.320,70
40mm	3.191,80	1.761,00
50mm	3.989,70	2.201,30

SBR 65 +/- 10 Sh., 5 MPa		
Stärke	Preis	
	1 - 11,99m <sup>2</sup>	12 - 119,99m <sup>2</sup>
1mm	142,50	73,30
1,5mm	213,70	110,10
2mm	286,40	147,50
2,5mm	347,90	179,20
3mm	417,40	214,90
3,5mm	486,10	250,30
4mm	555,60	286,10
5mm	695,20	358,00
6mm	833,30	429,20
8mm	1.112,60	572,90
10mm	1.390,40	715,90
12mm	1.668,20	859,00
15mm	2.085,60	1.074,00
20mm	2.782,20	1.432,70
25mm	3.477,50	1.790,60
30mm	4.172,70	2.148,70
40mm	5.564,50	2.865,30
50mm	6.954,90	3.581,40

SBR 65 +/- 10 Sh., 7-8 MPa		
Stärke	Preis	
	1 - 11,99m <sup>2</sup>	12 - 119,99m <sup>2</sup>
1mm	217,10	133,60
1,5mm	294,90	181,50
2mm	393,30	242,10
2,5mm	491,60	302,60
3mm	590,40	363,40
3,5mm	688,80	424,00
4mm	786,60	484,20
5mm	982,80	604,90
6mm	1.179,90	726,30
8mm	1.572,30	967,80
10mm	1.965,60	1.209,80
12mm	2.358,80	1.452,00
15mm	2.948,30	1.814,70
20mm	3.931,10	2.419,60
25mm	4.911,10	3.022,80
30mm	6.975,70	3.628,90
40mm	7.861,30	4.838,70
50mm	9.825,80	6.048,00

<b>ADI01 SBR 50 +/- 5 Sh., 4 MPa</b>		
 Stärke	Preis	
	1 - 11,99m <sup>2</sup>	12 - 119,99m <sup>2</sup>
1mm	198,00	110,10
2mm	396,00	220,00
3mm	594,00	330,00
4mm	792,00	440,00
5mm	990,00	550,00
6mm	1.188,00	660,00
8mm	1.584,00	880,00
10mm	1.980,00	1.100,00
12mm	2.376,00	1.320,00
15mm	2.970,00	1.650,00
20mm	3.960,00	2.200,00
25mm	4.950,00	2.750,00
30mm	5.940,00	3.300,00
40mm	7.920,00	4.400,00
50mm	9.900,00	5.500,00

<b>ADI01 SBR 60 +/- 5 Sh., FDA hell, 6 MPa</b>		
 Stärke	Preis	
	1 - 11,99m <sup>2</sup>	12 - 119,99m <sup>2</sup>
1mm	684,00	380,10
2mm	1.368,00	760,00
3mm	2.052,00	1.140,00
4mm	2.736,00	1.520,00
5mm	3.420,00	1.900,00
6mm	4.104,00	2.280,00
8mm	5.472,00	3.040,00
10mm	6.840,00	3.800,00
12mm	8.208,00	4.560,00
15mm	10.260,00	5.700,00
20mm	13.680,00	7.600,00
25mm	17.100,00	9.470,80
30mm	20.520,00	11.400,00
40mm	27.360,00	15.200,00
50mm	34.200,00	19.000,00

<b>ADI01 NR/SBR 70 +/- 5 Sh. mit Talkum, 3-4 MPa</b>		
 Stärke	Preis	
	1 - 11,99m <sup>2</sup>	12 - 119,99m <sup>2</sup>
1mm	156,00	86,60
2mm	312,00	173,30
3mm	435,60	242,00
4mm	580,80	321,80
5mm	726,00	403,40
6mm	871,20	483,90
8mm	1.161,60	645,30
10mm	1.452,00	806,70
12mm	1.742,40	968,00
15mm	2.178,00	1.210,00
20mm	2.904,00	1.613,30
25mm	3.630,00	2.016,70
30mm	4.356,00	2.420,00
40mm	5.808,00	3.226,70
50mm	7.260,00	4.033,40

<b>SBR 65 +/- 10 Sh., 2-3 MPa mit einer Textileinlage</b>		
 Stärke	Preis	
	1 - 11,99m <sup>2</sup>	12 - 119,99m <sup>2</sup>
2mm	225,30	104,90
2,5mm	281,60	131,10
3mm	338,70	157,70
3,5mm	395,20	183,90
4mm	450,60	209,70
5mm	564,00	262,50
6mm	675,80	314,60
8mm	901,00	419,50
10mm	1.126,30	524,30
12mm	1.426,10	663,90
15mm	1.780,40	828,80
20mm	2.377,00	1.106,60
25mm	2.971,20	1.383,20
30mm	3.565,40	1.659,70
40mm	4.753,90	2.213,00
50mm	5.942,40	2.766,30

<b>SBR 65 +/- 10 Sh., 5 MPa mit einer Textileinlage</b>		
 Stärke	Preis	
	1 - 11,99m <sup>2</sup>	12 - 119,99m <sup>2</sup>
2mm	388,40	180,80
2,5mm	437,00	226,00
3mm	526,60	245,20
3,5mm	554,30	286,60
4mm	703,70	327,60
5mm	879,30	409,30
6mm	1.054,80	491,10
8mm	1.407,60	655,20
10mm	1.760,20	819,40
12mm	2.111,30	982,80
15mm	2.639,50	1.228,70
20mm	3.520,40	1.638,80
25mm	4.400,50	2.048,50
30mm	5.280,60	2.458,20
40mm	7.040,70	3.277,60
50mm	8.801,00	4.097,00

<b>SBR 65 +/- 10 Sh., 2-3 MPa mit einer Nyloneinlage</b>		
 Stärke	Preis	
	1 - 11,99m <sup>2</sup>	12 - 119,99m <sup>2</sup>
2mm	356,50	166,00
2,5mm	413,90	192,70
3mm	461,40	214,80
3,5mm	511,70	238,20
4mm	565,20	263,10
5mm	668,70	311,40
6mm	772,50	359,60
8mm	979,90	456,20
10mm	1.187,40	552,70
12mm	1.394,70	649,30
15mm	1.706,90	794,70
20mm	2.250,00	1.047,40
25mm	2.812,50	1.309,30
30mm	3.299,80	1.536,10
40mm	4.444,00	2.068,70
50mm	5.518,40	2.568,90

**SBR 65 +/- 10 Sh., 2-3 MPa  
mit zwei Textileinlagen**

Stärke	Preis	
	1 - 11,99m <sup>2</sup>	12 - 119,99m <sup>2</sup>
4mm	<b>576,70</b>	<b>268,50</b>
5mm	<b>721,20</b>	<b>335,80</b>
6mm	<b>865,70</b>	<b>403,10</b>
8mm	<b>1.154,70</b>	<b>537,50</b>
10mm	<b>1.443,60</b>	<b>672,10</b>
12mm	<b>1.731,50</b>	<b>806,00</b>
15mm	<b>2.164,90</b>	<b>1.007,70</b>
20mm	<b>2.886,20</b>	<b>1.343,50</b>
25mm	<b>3.607,60</b>	<b>1.679,40</b>
30mm	<b>4.329,80</b>	<b>2.015,60</b>
40mm	<b>5.893,50</b>	<b>2.743,50</b>
50mm	<b>7.367,40</b>	<b>3.429,60</b>



*...dichtet sofort*

# GUMMIPLATTEN

## NBR-GUMMIPLATTEN

GUMMIPLATTEN

**NBR/SBR 65 +/- 5 Sh., 2-3 MPa**

Stärke	Preis	
	1 - 11,99m <sup>2</sup>	12 - 119,99m <sup>2</sup>
1mm	<b>167,20</b>	<b>89,20</b>
1,5mm	<b>241,90</b>	<b>124,10</b>
2mm	<b>310,00</b>	<b>165,30</b>
2,5mm	<b>372,50</b>	<b>198,70</b>
3mm	<b>466,20</b>	<b>248,70</b>
3,5mm	<b>522,00</b>	<b>278,50</b>
4mm	<b>621,20</b>	<b>331,30</b>
5mm	<b>776,20</b>	<b>414,00</b>
6mm	<b>931,20</b>	<b>496,70</b>
8mm	<b>1.242,40</b>	<b>662,40</b>
10mm	<b>1.552,40</b>	<b>828,00</b>
12mm	<b>1.862,40</b>	<b>993,30</b>
15mm	<b>2.327,30</b>	<b>1.241,20</b>
20mm	<b>3.103,50</b>	<b>1.655,20</b>
25mm	<b>4.078,10</b>	<b>2.069,10</b>
30mm	<b>4.655,90</b>	<b>2.482,90</b>
40mm	<b>6.206,90</b>	<b>3.310,50</b>
50mm	<b>7.759,30</b>	<b>4.138,10</b>

**NBR/SBR 65 +/- 5 Sh., 5 MPa**

Stärke	Preis	
	1 - 11,99m <sup>2</sup>	12 - 119,99m <sup>2</sup>
1mm	<b>203,90</b>	<b>116,50</b>
1,5mm	<b>305,90</b>	<b>174,70</b>
2mm	<b>407,80</b>	<b>233,10</b>
2,5mm	<b>509,80</b>	<b>291,30</b>
3mm	<b>603,60</b>	<b>344,80</b>
3,5mm	<b>705,30</b>	<b>403,10</b>
4mm	<b>806,10</b>	<b>460,60</b>
5mm	<b>1.007,30</b>	<b>575,60</b>
6mm	<b>1.208,50</b>	<b>690,60</b>
8mm	<b>1.612,20</b>	<b>924,50</b>
10mm	<b>2.015,90</b>	<b>1.151,90</b>
12mm	<b>2.418,30</b>	<b>1.381,90</b>
15mm	<b>3.023,20</b>	<b>1.727,60</b>
20mm	<b>4.031,90</b>	<b>2.304,00</b>
25mm	<b>5.039,90</b>	<b>2.879,90</b>
30mm	<b>6.047,90</b>	<b>3.455,90</b>
40mm	<b>8.063,80</b>	<b>4.607,90</b>
50mm	<b>10.078,50</b>	<b>5.759,10</b>

**NBR/SBR 65 +/- 5 Sh., 7-8 MPa**

Stärke	Preis	
	1 - 11,99m <sup>2</sup>	12 - 119,99m <sup>2</sup>
1mm	<b>282,40</b>	<b>161,40</b>
1,5mm	<b>390,00</b>	<b>222,80</b>
2mm	<b>519,90</b>	<b>297,10</b>
2,5mm	<b>649,90</b>	<b>371,40</b>
3mm	<b>780,00</b>	<b>445,70</b>
3,5mm	<b>909,90</b>	<b>519,90</b>
4mm	<b>1.039,90</b>	<b>594,20</b>
5mm	<b>1.298,90</b>	<b>742,20</b>
6mm	<b>1.559,80</b>	<b>891,30</b>
8mm	<b>2.078,90</b>	<b>1.187,90</b>
10mm	<b>2.598,80</b>	<b>1.485,00</b>
12mm	<b>3.118,70</b>	<b>1.782,10</b>
15mm	<b>3.897,70</b>	<b>2.227,30</b>
20mm	<b>5.197,60</b>	<b>2.970,00</b>
25mm	<b>6.497,00</b>	<b>3.712,50</b>
30mm	<b>7.796,30</b>	<b>4.455,10</b>
40mm	<b>10.478,70</b>	<b>5.987,80</b>
50mm	<b>13.096,90</b>	<b>7.484,00</b>



ADI01 NBR 65 +/- 5 Sh. mit Talkum, 5 MPa		
Stärke	Preis	
	1 - 11,99m <sup>2</sup>	12 - 119,99m <sup>2</sup>
1mm	240,00	133,40
2mm	480,00	266,70
3mm	720,00	400,00
4mm	960,00	533,30
5mm	1.200,00	666,70
6mm	1.440,00	800,00
8mm	1.920,00	1.066,70
10mm	2.400,00	1.333,40
12mm	2.880,00	1.600,00
15mm	3.600,00	2.000,10
20mm	4.800,00	2.666,60
25mm	6.000,00	3.333,30
30mm	7.200,00	4.000,00
40mm	9.600,00	5.333,40
50mm	12.000,00	6.666,60

ADI01 NBR 60 +/- 5 Sh., FDA hell, 5 MPa		
Stärke	Preis	
	1 - 11,99m <sup>2</sup>	12 - 119,99m <sup>2</sup>
1mm	702,00	390,00
2mm	1.404,00	780,00
3mm	2.106,00	1.170,00
4mm	2.808,00	1.560,00
5mm	3.510,00	1.950,00
6mm	4.212,00	2.340,00
8mm	5.616,00	3.120,00
10mm	7.020,00	3.900,00
12mm	8.424,00	4.680,00
15mm	10.530,00	5.850,00
20mm	14.040,00	7.800,00
25mm	17.550,00	9.750,00
30mm	21.060,00	11.700,00
40mm	28.080,00	15.600,00
50mm	35.100,00	19.500,00

NBR/SBR 65 +/- 5 Sh., 2-3 MPa mit einer Textileinlage		
Stärke	Preis	
	1 - 11,99m <sup>2</sup>	12 - 119,99m <sup>2</sup>
2mm	323,60	184,90
2,5mm	405,50	231,80
3mm	486,60	278,10
3,5mm	566,10	323,60
4mm	647,00	369,80
5mm	810,20	463,00
6mm	977,40	558,50
8mm	1.294,20	739,50
10mm	1.614,90	922,90
12mm	1.943,90	1.110,80
15mm	2.429,20	1.388,10
20mm	3.239,40	1.851,10
25mm	4.049,20	2.313,90
30mm	4.859,80	2.777,00
40mm	6.478,80	3.702,10
50mm	8.099,10	4.628,10

NBR/SBR 65 +/- 5 Sh., 5 MPa mit einer Textileinlage		
Stärke	Preis	
	1 - 11,99m <sup>2</sup>	12 - 119,99m <sup>2</sup>
2mm	435,00	248,60
2,5mm	543,80	310,70
3mm	645,70	368,90
3,5mm	755,40	431,60
4mm	860,40	491,70
5mm	1.075,20	614,40
6mm	1.291,40	738,00
8mm	1.721,10	983,40
10mm	2.151,90	1.229,70
12mm	2.582,80	1.475,90
15mm	3.227,10	1.844,10
20mm	4.303,80	2.459,30
25mm	5.379,70	3.074,10
30mm	6.455,70	3.689,00
40mm	8.607,60	4.918,60
50mm	10.759,50	6.148,20

NBR/SBR 65 +/- 5 Sh., 2-3 MPa mit einer Nyloneinlage		
Stärke	Preis	
	1 - 11,99m <sup>2</sup>	12 - 119,99m <sup>2</sup>
2mm	424,10	242,40
2,5mm	475,70	271,80
3mm	571,00	326,30
3,5mm	666,10	380,60
4mm	717,80	410,20
5mm	864,60	494,10
6mm	1.011,40	577,90
8mm	1.305,10	745,70
10mm	1.598,60	913,60
12mm	1.863,10	1.081,30
15mm	2.332,70	1.332,90
20mm	3.115,70	1.780,40
25mm	3.894,60	2.225,40
30mm	4.608,40	2.633,40
40mm	6.198,80	3.542,20
50mm	7.715,80	4.409,10

NBR/SBR 65 +/- 5 Sh., 2-3 MPa mit zwei Textileinlagen		
Stärke	Preis	
	1 - 11,99m <sup>2</sup>	12 - 119,99m <sup>2</sup>
4mm	790,00	420,10
5mm	986,90	524,90
6mm	1.183,80	629,50
8mm	1.578,90	839,60
10mm	1.973,80	1.111,40
12mm	2.367,70	1.333,30
15mm	2.959,50	1.666,50
20mm	3.946,40	2.222,20
25mm	4.933,30	2.778,00
30mm	5.920,20	3.333,60
40mm	8.117,80	4.571,10
50mm	10.148,70	5.714,70

# GUMMIPLATTEN

EPDM-GUMMIPLATTEN



GUMMIPLATTEN

EPDM/SBR 65 +/- 5 SH., 2-3 MPa		
Stärke	Preis	
	1 - 11,99m <sup>2</sup>	12 - 119,99m <sup>2</sup>
1mm	133,80	95,60
1,5mm	203,40	145,30
2mm	248,00	177,10
2,5mm	313,20	223,70
3mm	373,00	266,40
3,5mm	438,30	313,10
4mm	486,20	355,00
5mm	621,00	443,60
6mm	745,00	532,10
8mm	993,90	710,00
10mm	1.241,90	887,10
12mm	1.489,90	1.064,20
15mm	1.861,80	1.330,10
20mm	2.482,80	1.773,40
25mm	3.103,70	2.216,90
30mm	3.724,70	2.660,50
40mm	4.965,50	3.546,80
50mm	6.207,40	4.433,90

EPDM/SBR 65 +/- 5 Sh., 5 MPa		
Stärke	Preis	
	1 - 11,99m <sup>2</sup>	12 - 119,99m <sup>2</sup>
1mm	157,70	112,60
1,5mm	237,10	169,30
2mm	298,00	212,90
2,5mm	372,50	266,00
3mm	447,00	319,20
3,5mm	521,40	372,50
4mm	595,90	425,60
5mm	745,00	532,10
6mm	893,90	638,50
8mm	1.190,80	850,60
10mm	1.489,90	1.064,20
12mm	1.786,80	1.276,20
15mm	2.233,80	1.595,50
20mm	2.978,60	2.127,60
25mm	3.723,60	2.659,70
30mm	4.468,50	3.180,10
40mm	5.957,30	4.255,20
50mm	7.447,20	5.319,40

EPDM/SBR 65 +/- 5 Sh., 7-8 MPa		
Stärke	Preis	
	1 - 11,99m <sup>2</sup>	12 - 119,99m <sup>2</sup>
1mm	251,00	151,80
1,5mm	376,60	227,90
2mm	462,20	279,60
2,5mm	577,30	349,30
3mm	693,30	419,50
3,5mm	808,80	489,30
4mm	924,40	559,30
5mm	1.154,50	698,50
6mm	1.386,60	838,90
8mm	1.847,90	1.118,00
10mm	2.310,00	1.397,60
12mm	2.772,30	1.677,30
15mm	3.464,60	2.096,20
20mm	4.620,00	2.795,40
25mm	5.775,10	3.494,10
30mm	6.930,10	4.193,00
40mm	9.314,50	5.635,70
50mm	11.641,60	7.043,80

EPDM/SBR 65 +/- 5 SH., 2-3 MPa mit einer Textileinlage		
Stärke	Preis	
	1 - 11,99m <sup>2</sup>	12 - 119,99m <sup>2</sup>
2mm	371,30	185,70
2,5mm	463,50	231,80
3mm	556,20	278,10
3,5mm	649,80	325,00
4mm	742,60	371,30
5mm	927,50	463,80
6mm	1.112,40	556,20
8mm	1.483,70	741,90
10mm	1.851,90	925,90
12mm	2.221,60	1.110,80
15mm	2.776,20	1.388,10
20mm	3.702,10	1.851,10
25mm	4.627,80	2.313,90
30mm	5.554,00	2.777,00
40mm	7.404,40	3.702,10
50mm	9.256,10	4.628,10

EPDM/SBR 65 +/- 5 Sh., 5 MPa mit einer Textileinlage		
Stärke	Preis	
	1 - 11,99m <sup>2</sup>	12 - 119,99m <sup>2</sup>
2mm	402,70	253,60
2,5mm	498,20	313,60
3mm	597,80	376,40
3,5mm	697,00	438,90
4mm	796,60	501,60
5mm	995,40	626,70
6mm	1.195,50	752,70
8mm	1.593,10	1.003,10
10mm	1.992,10	1.254,20
12mm	2.390,90	1.505,40
15mm	2.987,40	1.880,90
20mm	3.984,10	2.508,50
25mm	4.980,10	3.135,60
30mm	5.976,10	3.762,70
40mm	7.968,10	5.017,00
50mm	9.960,20	6.271,20

EPDM/SBR 65 +/- 5 Sh., 2-3 MPa mit einer Nyloneinlage		
Stärke	Preis	
	1 - 11,99m <sup>2</sup>	12 - 119,99m <sup>2</sup>
2mm	433,90	248,00
2,5mm	488,60	279,20
3mm	586,20	335,00
3,5mm	645,80	369,00
4mm	738,20	421,80
5mm	889,10	508,00
6mm	1.040,90	594,90
8mm	1.344,70	768,40
10mm	1.647,50	941,40
12mm	1.951,30	1.115,10
15mm	2.442,70	1.395,90
20mm	3.213,50	1.836,30
25mm	4.017,00	2.295,40
30mm	4.828,50	2.759,20
40mm	6.394,50	3.654,00
50mm	7.960,50	4.548,90

ADI01 EPDM 65 +/- 5 Sh.		
Stärke	Preis	
	1 - 11,99m <sup>2</sup>	12 - 119,99m <sup>2</sup>
1mm	270,00	150,00
2mm	540,00	300,00
3mm	810,00	450,00
4mm	1.080,00	600,00
5mm	1.350,00	750,00
6mm	1.620,00	900,00
8mm	2.160,00	1.200,00
10mm	2.700,00	1.500,00
12mm	3.240,00	1.800,00
15mm	4.050,00	2.250,00
20mm	5.400,00	3.000,00
25mm	6.750,00	3.750,00
30mm	8.100,00	4.500,00
40mm	10.800,00	6.000,00
50mm	13.500,00	7.500,00

ADI01 EPDM 60 +/- 5 Sh., FDA		
Stärke	Preis	
	1 - 11,99m <sup>2</sup>	12 - 119,99m <sup>2</sup>
1mm	894,00	496,70
2mm	1.788,00	993,40
3mm	2.682,00	1.490,00
4mm	3.576,00	1.986,70
5mm	4.470,00	2.483,40
6mm	5.364,00	2.980,00
8mm	7.152,00	3.973,30
10mm	8.940,00	4.966,70
12mm	10.728,00	5.960,00
15mm	13.410,00	7.449,90
20mm	17.800,00	9.933,30
25mm	22.350,00	12.416,70
30mm	26.820,00	14.900,00
40mm	35.760,00	19.866,70
50mm	44.700,00	24.833,30

EPDM/SBR 65 +/- 5 Sh., 2-3 MPa, 2x textilní vložka		
Stärke	Preis	
	1 - 11,99m <sup>2</sup>	12 - 119,99m <sup>2</sup>
4mm	823,80	438,00
5mm	1.028,80	547,10
6mm	1.235,10	656,90
8mm	1.646,40	875,60
10mm	2.057,70	1.158,70
12mm	2.469,00	1.390,30
15mm	3.086,50	1.738,00
20mm	4.115,40	2.317,40
25mm	5.144,30	2.896,70
30mm	6.173,10	3.476,10
40mm	8.345,10	4.699,10
50mm	10.430,60	5.873,50

# GUMMIPLATTEN

## CR-GUMMIPLATTEN

CR-GUMMIPLATTEN

CR/SBR 65 +/- 5 Sh., 2-3 MPa		
Stärke	Preis	
	1 - 11,99m <sup>2</sup>	12 - 119,99m <sup>2</sup>
1mm	167,30	95,60
1,5mm	255,50	146,00
2mm	310,00	177,10
2,5mm	286,70	225,60
3mm	466,30	266,40
3,5mm	552,40	315,70
4mm	621,30	355,00
5mm	776,30	443,60
6mm	931,20	532,10
8mm	1.242,40	710,00
10mm	1.396,10	797,80
12mm	1.552,40	887,10
15mm	1.862,40	1.064,20
20mm	2.483,20	1.419,00
25mm	2.909,10	1.662,30
30mm	3.103,50	1.773,50
40mm	4.137,90	2.364,60
50mm	5.173,20	2.956,20

CR/SBR 65 +/- 5 Sh., 5 MPa		
Stärke	Preis	
	1 - 11,99m <sup>2</sup>	12 - 119,99m <sup>2</sup>
1mm	197,10	112,60
1,5mm	232,40	132,80
2mm	372,50	212,90
2,5mm	465,60	266,00
3mm	558,70	319,20
3,5mm	651,80	372,50
4mm	745,00	425,60
5mm	931,20	532,10
6mm	1.117,40	638,50
8mm	1.488,60	850,60
10mm	1.862,40	1.064,20
12mm	2.233,40	1.276,20
15mm	2.791,80	1.595,30
20mm	3.723,30	2.127,60
25mm	4.654,30	2.659,60
30mm	5.585,00	3.191,40
40mm	7.446,70	4.255,20
50mm	9.308,30	5.319,00

CR/SBR 65 +/- 5 Sh., 7-8 MPa		
Stärke	Preis	
	1 - 11,99m <sup>2</sup>	12 - 119,99m <sup>2</sup>
1mm	282,40	161,40
1,5mm	390,00	222,80
2mm	519,90	297,10
2,5mm	649,90	371,40
3mm	780,00	445,70
3,5mm	909,90	519,90
4mm	1.039,90	594,20
5mm	1.298,90	742,20
6mm	1.559,80	891,30
8mm	2.078,80	1.187,90
10mm	2.598,80	1.485,00
12mm	3.118,70	1.782,10
15mm	3.897,70	2.227,30
20mm	5.197,60	2.970,00
25mm	6.497,00	3.712,50
30mm	7.796,30	4.455,10
40mm	10.478,70	5.987,80
50mm	13.096,90	7.484,00

CR/SBR 65 +/- 5 Sh., 2-3 MPa mit einer Textileinlage		
Stärke	Preis	
	1 - 11,99m <sup>2</sup>	12 - 119,99m <sup>2</sup>
2mm	369,80	246,50
2,5mm	463,40	309,00
3mm	556,20	370,80
3,5mm	647,00	431,40
4mm	739,50	493,00
5mm	925,90	617,30
6mm	1.117,00	744,70
8mm	1.479,00	986,00
9mm	1.660,70	1.107,20
10mm	1.845,60	1.230,40
12mm	2.221,60	1.481,10
15mm	2.776,20	1.850,80
20mm	3.702,10	2.468,10
25mm	4.627,70	3.085,10
30mm	5.554,00	3.702,70
40mm	7.404,40	4.936,20
50mm	9.256,10	6.170,80

CR/SBR 65 +/- 5 Sh., 5 MPa mit einer Textileinlage		
Stärke	Preis	
	1 - 11,99m <sup>2</sup>	12 - 119,99m <sup>2</sup>
2mm	460,60	263,20
2,5mm	575,70	329,00
3mm	683,60	390,60
3,5mm	799,70	456,90
4mm	911,10	520,70
5mm	1.138,50	650,60
6mm	1.367,40	781,40
8mm	1.822,20	1.041,20
10mm	2.278,50	1.301,90
12mm	2.734,80	1.562,80
15mm	3.417,00	1.952,50
20mm	4.557,00	2.604,00
25mm	5.696,10	3.255,00
30mm	6.835,40	3.905,90
40mm	9.113,90	5.208,00
50mm	11.392,40	6.509,90

CR/SBR 65 +/- 5 Sh., 2-3MPa mit einer Nyloneinlage		
Stärke	Preis	
	1 - 11,99m <sup>2</sup>	12 - 119,99m <sup>2</sup>
2mm	551,00	257,10
2,5mm	620,40	289,50
3mm	744,40	347,40
3,5mm	820,20	382,80
4mm	937,30	437,40
5mm	1.128,90	526,80
6mm	1.321,80	616,90
8mm	1.707,60	796,90
10mm	2.092,20	976,30
12mm	2.478,00	1.156,40
15mm	3.102,00	1.447,60
20mm	4.080,70	1.904,40
25mm	5.100,80	2.380,40
30mm	6.131,40	2.861,40
40mm	8.120,00	3.789,30
50mm	10.108,60	4.717,30

CR/SBR 65 +/- 5 Sh., 2-3 MPa mit zwei Textileinlagen		
Stärke	Preis	
	1 - 11,99m <sup>2</sup>	12 - 119,99m <sup>2</sup>
4mm	790,00	378,10
5mm	986,90	472,40
6mm	1.183,80	566,60
8mm	1.578,90	755,70
10mm	1.973,80	944,80
12mm	2.367,70	1.133,20
15mm	2.959,50	1.416,50
20mm	3.946,40	1.888,90
25mm	4.933,10	2.361,20
30mm	5.920,20	2.833,60
40mm	8.117,80	3.885,40
50mm	10.148,70	4.857,50

# GUMMIPLATTEN

FPM-, SILIKON-, NR-, PU-GUMMIPLATTEN

GUMMIPLATTEN

## FPM 70 +/- 5 Sh.

Stärke	Preis	
	1 - 11,99m <sup>2</sup>	12 - 119,99m <sup>2</sup>
1mm	4.000,30	2.165,60
1,5mm	5.789,30	3.134,10
2mm	7.719,10	4.178,70
2,5mm	9.648,90	5.223,40
3mm	11.578,70	6.268,10
3,5mm	13.508,40	7.312,00
4mm	15.438,30	8.357,60
5mm	19.295,70	10.445,80
6mm	23.126,50	12.519,60
8mm	30.844,50	16.697,80
10mm	38.595,60	20.893,90
12mm	46.314,70	25.072,60
15mm	57.893,40	31.340,70
20mm	77.191,20	41.787,70

## Silikon 60 +/- 5 Sh., weiß, rot, transparent, grün

Stärke	Preis	
	1 - 11,99m <sup>2</sup>	12 - 119,99m <sup>2</sup>
1mm	834,20	476,70
1,5mm	1.217,10	695,50
2mm	1.622,70	927,30
2,5mm	2.028,60	1.159,20
3mm	2.434,10	1.390,90
3,5mm	2.840,20	1.622,90
4mm	3.245,90	1.854,80
5mm	4.056,80	2.318,10
6mm	4.868,10	2.781,80
8mm	5.980,00	3.417,10
10mm	8.113,40	4.636,20
12mm	9.736,10	5.563,50
15mm	12.170,20	6.954,30
20mm	16.226,80	9.272,40

## NR/SBR 50 +/- 5 Sh., grau / weiß

Stärke	Preis	
	1 - 11,99m <sup>2</sup>	12 - 119,99m <sup>2</sup>
1mm	315,10	225,10
1,5mm	472,70	337,60
2mm	630,30	450,10
2,5mm	787,90	562,80
3mm	946,40	676,00
3,5mm	1.103,90	788,50
4mm	1.261,50	901,00
5mm	1.576,60	1.126,10
6mm	1.891,70	1.351,30
8mm	2.837,20	2.026,50
10mm	3.152,30	2.251,70
12mm	3.782,60	2.701,80
15mm	4.728,90	3.377,80
20mm	6.304,60	4.503,30
25mm	7.880,80	5.629,10
30mm	9.456,90	6.755,00
40mm	12.609,20	9.006,60
50mm	15.761,50	11.258,20

## ADI01 NR 40 +/- 5 Sh. grau / beige

Stärke	Preis	
	1 - 11,99m <sup>2</sup>	12 - 119,99m <sup>2</sup>
1mm	823,20	457,40
1,5mm	1.234,80	686,00
2mm	1.646,40	914,70
2,5mm	2.058,00	1.143,30
3mm	2.469,60	1.372,00
3,5mm	3.292,80	1.829,30
4mm	4.116,00	2.286,70
5mm	4.939,20	2.744,00
6mm	6.585,60	3.658,70
8mm	8.232,00	4.573,40
10mm	12.348,00	6.860,10
12mm	16.464,00	9.146,60
15mm	20.580,00	11.433,30
20mm	24.696,00	13.720,00
25mm	20.580,00	11.433,30
30mm	24.696,00	13.720,00
40mm	32.928,00	18.293,40
50mm	41.160,00	22.866,60

## PU 70 70 +/- 5 Sh., braun

Stärke	Preis	
	1 - 11,99m <sup>2</sup>	12 - 119,99m <sup>2</sup>
1mm	599,80	556,90
1,5mm	839,10	779,20
2mm	1.108,90	1.029,80
2,5mm	1.377,50	1.279,20
3mm	1.619,30	1.503,60
4mm	2.158,20	2.004,00
5mm	2.668,40	2.477,80
6mm	3.175,80	2.948,90
8mm	4.209,10	3.908,50
10mm	4.973,50	4.618,30
12mm	6.217,50	5.773,40
15mm	7.461,40	6.928,50
20mm	9.948,90	9.238,30

# GUMMIPLATTEN

## MIKROPORÖSE



Die Platten aus porösen Gummimischungen zeichnen sich durch geringe Wärmeleitfähigkeit, geringe Härte, hohe Elastizität, Undurchlässigkeit und Absorbierbarkeit aus. Durch diese Eigenschaften bietet sich die Verwendung von mikroporösen Gummiplatten überwiegend im Maschinenbau und in der Lufttechnik als Wärmeisolator,

Dichtungselement oder Schwingungs- und Lärmdämpfer an.

Sie können auf verschiedene Weisen bearbeitet werden, z. B. ausstanzen, schnitzen, kleben, usw.

Zudem können sie mit nicht aggressiven Stoffen wie Holz, Gummi, Glas, Wasser, Textilien in Kontakt kommen.

Manche mikroporöse Gummiplatten können mit einer selbstklebenden Schicht zur einfacheren Befestigung auf dem Untergrund versehen werden.

Die Untergrundoberfläche muss trocken, entfettet und glatt sein.



# GUMMIPLATTEN

MIKROPORÖSE

**CR-mikroporöse Gummiplatte – schwarz  
2000x1000mm - 140 +/- 25kg/m<sup>3</sup>**

Stärke	Preis	
	1 - 9,99m <sup>2</sup>	od 10m <sup>2</sup>
1mm	100,70	80,60
2mm	172,10	137,70
3mm	243,60	194,90
4mm	315,00	252,00
5mm	386,50	309,20
6mm	457,90	366,30
7mm	529,30	423,50
8mm	600,80	480,60
9mm	672,20	537,80
10mm	751,90	601,50
11mm	823,40	658,70
12mm	894,80	715,80
13mm	966,20	773,00
14mm	1.037,70	830,20
15mm	1.109,10	887,30
16mm	1.180,60	944,50
18mm	1.323,50	1.058,80
20mm	1.503,80	1.203,10
25mm	1.861,10	1.488,80
30mm	2.218,30	1.774,60
40mm	2.932,70	2.346,10
50mm	3.647,10	2.917,70

**CR-mikroporöse Gummiplatte – schwarz  
2000x1000mm - 175 +/- 25kg/m<sup>3</sup>**

Stärke	Preis	
	1 - 9,99m <sup>2</sup>	od 10m <sup>2</sup>
1mm	126,70	101,40
2mm	224,20	179,40
3mm	321,70	257,40
4mm	419,20	335,40
5mm	516,70	413,40
6mm	614,20	491,30
7mm	711,70	569,30
8mm	809,20	647,30
9mm	906,60	725,30
10mm	1.012,40	809,90
11mm	1.109,90	887,90
12mm	1.207,40	965,90
13mm	1.304,90	1.043,90
14mm	1.402,30	1.121,90
15mm	1.499,80	1.199,90
16mm	1.597,30	1.277,90
18mm	1.792,30	1.433,80
20mm	2.024,80	1.619,80
25mm	2.512,20	2.009,80
30mm	2.999,70	2.399,70
40mm	3.974,50	3.179,60
50mm	4.949,40	3.959,50

**CR-mikroporöse Gummiplatte – grau  
1900x1000mm - 195 +/- 25kg/m<sup>3</sup>**

Stärke	Preis	
	1 - 9,99m <sup>2</sup>	od 10m <sup>2</sup>
1mm	231,40	185,10
2mm	433,60	346,80
3mm	635,70	508,60
4mm	837,90	670,30
5mm	1.040,00	832,00
6mm	1.242,20	993,70
7mm	1.444,30	1.155,50
8mm	1.646,50	1.317,20
9mm	1.848,60	1.478,90
10mm	2.059,00	1.647,20
11mm	2.261,20	1.809,00
12mm	2.463,40	1.970,70
13mm	2.666,50	2.132,40
14mm	2.867,70	2.294,10
15mm	3.069,80	2.455,90
16mm	3.272,00	2.617,60
18mm	3.676,30	2.941,00
20mm	4.118,10	3.294,50
25mm	5.128,90	4.103,10
30mm	6.139,60	4.911,70

**Silikon-mikroporöse Gummiplatte 430kg/m<sup>3</sup>  
1000x2000mm**

Stärke	Preis			
	0,9 - 9,99m <sup>2</sup>	10 - 24,99m <sup>2</sup>	25 - 99,99m <sup>2</sup>	od 100m <sup>2</sup>
1,5mm	583,64	535,00	493,85	458,57
2mm	627,27	575,00	530,77	492,86
3mm	763,64	700,00	646,15	600,00
4mm	861,82	790,00	729,23	677,14
5mm	1.074,55	985,00	909,23	844,29
6mm	1.298,18	1.190,00	1.098,46	1.020,00
8mm	1.600,00	1.476,92	1.371,43	1.280,00
9mm	1.755,00	1.638,46	1.521,43	1.420,00
10mm	1.970,00	1.818,46	1.688,57	1.576,00
12mm	2.380,00	2.196,92	2.040,00	1.904,00
15mm	2.955,00	2.727,69	2.532,86	2.364,00
16mm	3.155,00	2.912,31	2.704,29	2.524,00
18mm	3.550,00	3.276,92	3.042,86	2.840,00
20mm	3.940,00	3.636,92	3.377,14	3.152,00
25mm	4.925,00	4.546,15	4.221,43	3.940,00

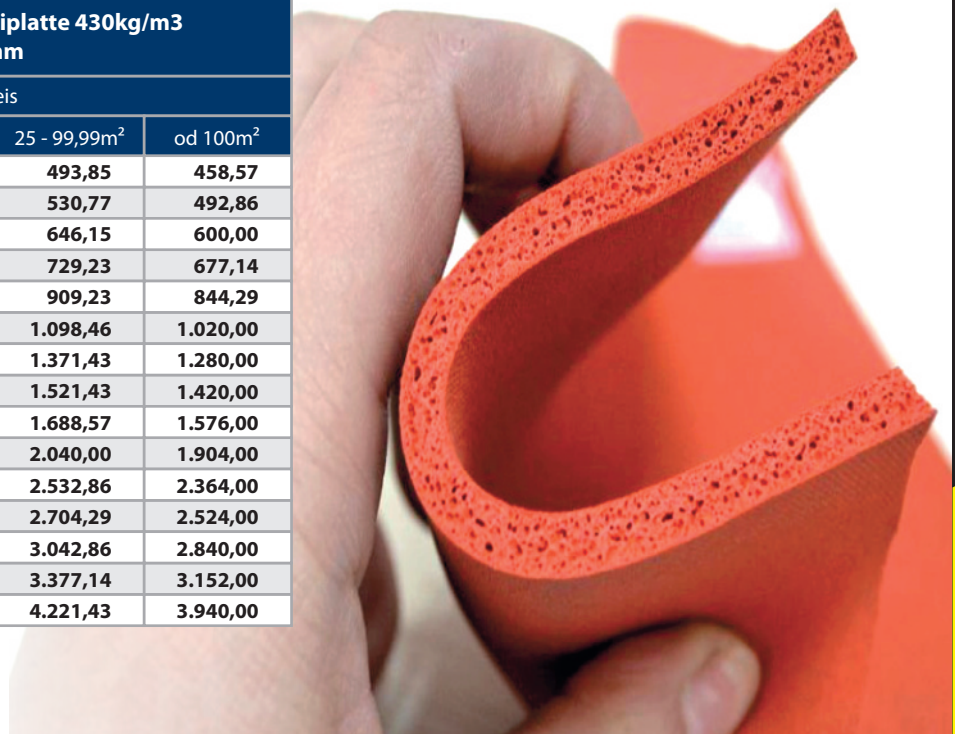

GUMMIPLATTEN

NBR-mikroporöse 2000x1000mm - 130 +/- 25kg/m <sup>3</sup>		
Stärke	Preis	
	1 - 9,99m <sup>2</sup>	od 10m <sup>2</sup>
1mm	141,90	113,50
2mm	254,60	203,70
3mm	367,30	293,80
4mm	480,00	384,00
5mm	592,70	474,10
6mm	705,30	564,30
7mm	818,00	654,40
8mm	930,70	744,60
9mm	1.043,40	834,70
10mm	1.164,30	931,50
11mm	1.277,00	1.021,60
12mm	1.389,70	1.111,70
13mm	1.502,40	1.201,90
14mm	1.615,00	1.292,00
15mm	1.727,70	1.382,20
16mm	1.840,40	1.472,30
18mm	2.065,80	1.652,60
20mm	2.328,60	1.862,90
25mm	2.892,00	2.313,60
30mm	3.455,40	2.764,40
40mm	4.582,30	3.665,80
50mm	5.709,10	4.567,30

NBR-mikroporöse 2000x1000mm - 165 +/- 25kg/m <sup>3</sup>		
Stärke	Preis	
	1 - 9,99m <sup>2</sup>	od 10m <sup>2</sup>
1mm	162,40	129,90
2mm	295,50	236,40
3mm	428,60	342,90
4mm	561,80	449,40
5mm	694,90	555,90
6mm	828,00	662,40
7mm	961,20	768,90
8mm	1.094,30	875,40
9mm	1.227,40	981,90
10mm	1.368,80	1.095,00
11mm	1.501,90	1.201,50
12mm	1.635,10	1.308,10
13mm	1.768,20	1.414,60
14mm	1.901,30	1.521,10
15mm	2.034,50	1.627,60
16mm	2.167,60	1.734,10
18mm	2.433,80	1.947,10
20mm	2.737,60	2.190,10
25mm	3.403,30	2.722,60
30mm	4.068,90	3.255,10
40mm	5.400,20	4.320,20
50mm	6.731,50	5.385,20

NBR-mikroporöse 1550x970mm - 180 +/- 25kg/m <sup>3</sup>		
Stärke	Preis	
	1 - 9,99m <sup>2</sup>	od 10m <sup>2</sup>
1mm	186,20	149,00
2mm	343,20	274,60
3mm	500,20	400,20
4mm	657,20	525,80
5mm	814,20	651,40
6mm	971,20	777,00
7mm	1.128,20	902,60
8mm	1.285,20	1.028,20
9mm	1.442,20	1.153,80
10mm	1.607,50	1.286,00
11mm	1.764,50	1.411,60
12mm	1.921,50	1.537,20
13mm	2.078,50	1.662,80
14mm	2.235,50	1.788,40
15mm	2.392,50	1.914,00
16mm	2.549,50	2.039,60
18mm	2.863,50	2.290,80
20mm	3.215,00	2.572,00
25mm	3.999,90	3.200,00
30mm	4.784,90	3.827,90
40mm	6.354,90	5.083,90
50mm	7.924,90	6.339,90

NBR-mikroporöse 1400x850mm - 295 +/- 25kg/m <sup>3</sup>		
Stärke	Preis	
	1 - 9,99m <sup>2</sup>	od 10m <sup>2</sup>
1mm	268,20	214,60
2mm	507,10	405,70
3mm	746,10	596,90
4mm	985,00	788,00
5mm	1.224,00	979,20
6mm	1.462,90	1.170,40
7mm	1.701,90	1.361,50
8mm	1.940,80	1.552,70
9mm	2.179,80	1.743,80
10mm	2.427,00	1.941,06
11mm	2.665,90	2.132,80
12mm	2.904,90	2.323,90
13mm	3.143,80	2.515,10
14mm	3.382,80	2.706,20
15mm	3.621,70	2.897,40
16mm	3.860,70	3.088,60
18mm	4.338,60	3.470,90
20mm	4.854,00	3.883,20
25mm	6.048,70	4.839,00
30mm	7.243,50	5.794,80
40mm	9.633,00	7.706,40
50mm	12.022,50	9.618,00

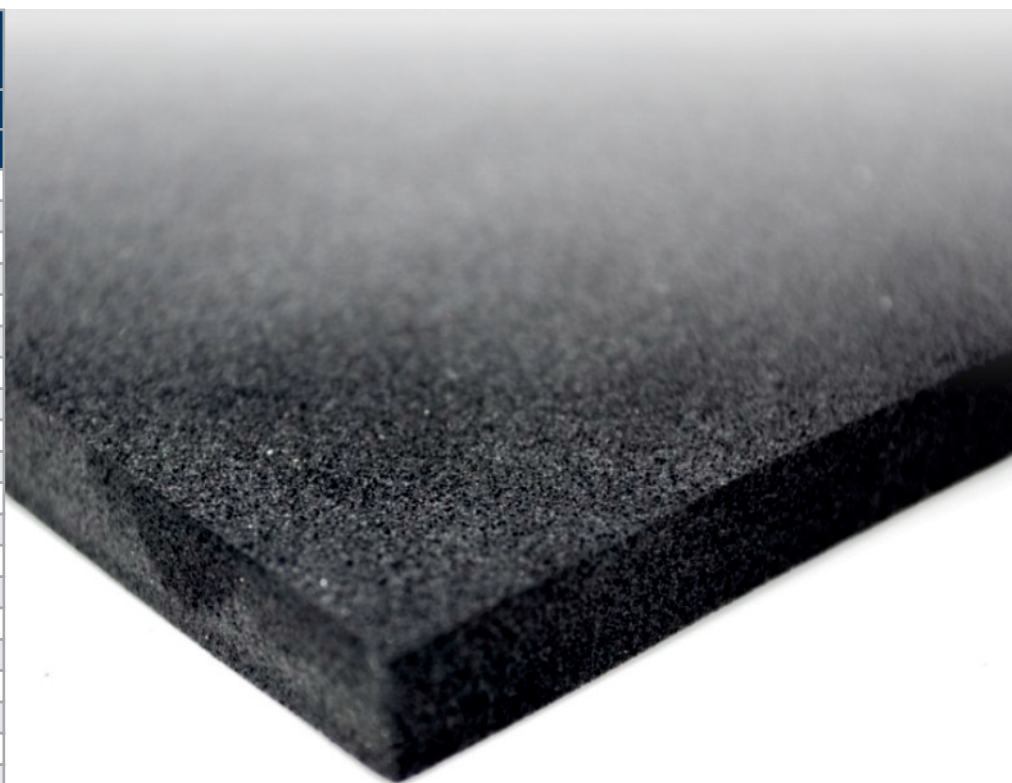



EPDM-mikroporöse 2000x1000mm - 75 +/- 15kg/m <sup>3</sup>		
Stärke	Preis	
	1 - 9,99m <sup>2</sup>	od 10m <sup>2</sup>
1mm	70,00	57,30
2mm	114,00	93,30
3mm	158,00	129,30
4mm	202,00	165,30
5mm	246,00	201,30
6mm	290,00	237,30
7mm	334,00	273,30
8mm	378,00	309,30
9mm	422,00	345,30
10mm	473,30	387,30
11mm	517,30	423,30
12mm	561,30	459,30
13mm	605,30	495,30
14mm	649,30	531,30
15mm	693,30	567,30
16mm	737,30	603,30
18mm	825,30	675,30
20mm	946,70	774,50
25mm	1.166,70	954,50
30mm	1.386,70	1.134,50
40mm	1.826,70	1.494,50
50mm	2.266,70	1.854,50

EPDM-mikroporöse 2000x1000mm - 90 +/- 20kg/m <sup>3</sup>		
Stärke	Preis	
	1 - 9,99m <sup>2</sup>	od 10m <sup>2</sup>
1mm	72,20	59,10
2mm	118,30	96,80
3mm	164,50	134,60
4mm	210,70	172,40
5mm	256,90	210,20
6mm	303,00	247,90
7mm	349,20	285,70
8mm	395,40	323,50
9mm	441,60	361,30
10mm	495,10	405,00
11mm	541,20	442,80
12mm	587,40	480,60
13mm	633,60	518,40
14mm	679,70	556,20
15mm	725,90	593,90
16mm	772,10	631,70
18mm	864,40	707,30
20mm	990,10	810,10
25mm	1.221,00	999,00
30mm	1.451,80	1.187,90
40mm	1.913,60	1.565,60
50mm	2.375,30	1.943,40

EPDM-mikroporöse 2000x1000mm - 115 +/- 25kg/m <sup>3</sup>		
Stärke	Preis	
	1 - 9,99m <sup>2</sup>	od 10m <sup>2</sup>
1mm	64,90	53,10
2mm	103,80	84,90
3mm	142,70	116,80
4mm	181,60	148,60
5mm	220,50	180,40
6mm	259,40	212,20
7mm	298,30	244,10
8mm	337,20	275,90
9mm	376,10	307,70
10mm	422,30	345,50
11mm	461,20	377,40
12mm	500,10	409,20
13mm	539,00	441,00
14mm	577,90	472,80
15mm	616,80	504,70
16mm	655,70	536,50
18mm	733,50	600,10
20mm	844,60	691,10
25mm	1.039,10	850,20
30mm	1.233,60	1.009,30
40mm	1.622,60	1.327,60
50mm	2.011,60	1.645,90

EPDM-mikroporöse 2000x1000mm - 130 +/- 20kg/m <sup>3</sup>		
Stärke	Preis	
	1 - 9,99m <sup>2</sup>	od 10m <sup>2</sup>
1mm	73,10	59,80
2mm	120,20	98,40
3mm	167,40	136,90
4mm	214,50	175,50
5mm	261,60	214,00
6mm	308,70	252,60
7mm	355,80	291,10
8mm	403,00	329,70
9mm	450,10	368,30
10mm	504,50	412,80
11mm	551,70	451,40
12mm	598,80	489,90
13mm	645,90	528,50
14mm	693,00	567,00
15mm	740,20	605,60
16mm	787,30	644,10
18mm	881,50	721,20
20mm	1.009,10	825,60
25mm	1.244,70	1.018,40
30mm	1.480,30	1.211,20
40mm	1.951,50	1.596,70
50mm	2.422,70	1.982,20

EPDM-mikroporöse 1600x1000mm - 175 +/- 25kg/m <sup>3</sup>		
Stärke	Preis	
	1 - 9,99m <sup>2</sup>	od 10m <sup>2</sup>
1mm	104,70	83,70
2mm	180,10	144,00
3mm	255,50	204,40
4mm	330,90	264,70
5mm	406,30	325,00
6mm	481,70	385,30
7mm	557,10	445,70
8mm	632,50	506,00
9mm	707,90	566,30
10mm	791,50	633,20
11mm	866,90	693,50
12mm	942,30	753,90
13mm	1.017,70	814,20
14mm	1.093,10	874,50
15mm	1.168,50	934,80
16mm	1.243,90	995,20
18mm	1.394,70	1.115,80
20mm	1.583,10	1.266,40
25mm	1.960,10	1.568,10
30mm	2.337,10	1.869,70
40mm	3.091,10	2.472,90
50mm	3.845,10	3.076,10

## PE-MIKROPORÖSE GUMMIPLATTEN

Mikroporöse Platte, geschlossene Poren mit ausgezeichneter Elastizität. **Farben:** schwarz, gelb, rot, blau, grün.

**Beständigkeit:** beständig gegen Witterungseinflüsse und UV-Strahlung. Ölbeständigkeit und mäßige Säurebeständigkeit.

PE-mikroporöse 33kg/m <sup>3</sup> 2000x1000mm - weiß + anthrazit		
tloušťka	Preis	
	1 - 9,99m <sup>2</sup>	10 - 99,99m <sup>2</sup>
1mm	31,30	28,90
2mm	43,20	39,90
3mm	55,00	50,80
4mm	66,90	61,70
5mm	78,70	72,70
6mm	90,50	83,60
7mm	102,40	94,50
8mm	114,20	105,40
9mm	126,10	116,40
10mm	143,40	132,40
11mm	155,30	143,30
12mm	167,10	154,20
13mm	178,90	165,20
14mm	190,80	176,10
15mm	202,60	187,00
16mm	214,50	198,00
18mm	238,10	219,80
20mm	286,80	264,80
25mm	346,00	319,40
30mm	405,20	374,10
40mm	523,70	483,40
50mm	642,10	592,70

PE-mikroporöse 33kg/m <sup>3</sup> 2000x1000mm - bunt		
tloušťka	Preis	
	1 - 9,99m <sup>2</sup>	10 - 99,99m <sup>2</sup>
1mm	32,50	30,00
2mm	45,50	42,00
3mm	58,40	54,00
4mm	71,40	65,90
5mm	84,40	77,90
6mm	97,40	89,90
7mm	110,40	101,90
8mm	123,40	113,90
9mm	136,30	125,90
10mm	154,80	142,90
11mm	167,80	154,90
12mm	180,80	166,90
13mm	193,80	178,90
14mm	206,80	190,90
15mm	219,70	202,80
16mm	232,70	214,80
18mm	258,70	238,80
20mm	309,70	285,80
25mm	374,60	345,80
30mm	439,50	405,70
40mm	569,30	525,50
50mm	699,10	645,40

PE-mikroporöse 45kg/m <sup>3</sup> 2000x1000mm - weiß + anthrazit		
tloušťka	Preis	
	1 - 9,99m <sup>2</sup>	10 - 99,99m <sup>2</sup>
1mm	34,70	32,00
2mm	49,90	46,10
3mm	65,10	60,10
4mm	80,30	74,10
5mm	95,50	88,10
6mm	110,70	102,20
7mm	125,90	116,20
8mm	141,10	130,20
9mm	156,30	144,30
10mm	177,00	163,40
11mm	192,20	177,40
12mm	207,40	191,40
13mm	222,60	205,50
14mm	237,80	219,50
15mm	253,00	233,50
16mm	268,20	247,50
18mm	298,60	275,60
20mm	354,00	326,70
25mm	429,90	396,90
30mm	505,90	467,00
40mm	657,90	607,30
50mm	809,90	747,60

PE-mikroporöse 45kg/m <sup>3</sup> 2000x1000mm - bunt		
tloušťka	Preis	
	1 - 9,99m <sup>2</sup>	10 - 99,99m <sup>2</sup>
1mm	36,20	33,40
2mm	52,80	48,80
3mm	69,50	64,20
4mm	86,20	79,60
5mm	102,90	95,00
6mm	119,50	110,40
7mm	136,20	125,70
8mm	152,90	141,10
9mm	169,60	156,50
10mm	191,70	177,00
11mm	208,40	192,40
12mm	225,10	207,80
13mm	241,80	223,20
14mm	258,40	238,60
15mm	275,10	254,00
16mm	291,80	269,30
18mm	325,10	300,10
20mm	383,50	354,00
25mm	466,90	431,00
30mm	550,20	507,90
40mm	717,00	661,80
50mm	883,70	815,80

PE-mikroporöse 60kg/m <sup>3</sup> 2000x1000mm - weiß + anthrazit		
tloušťka	Preis	
	1 - 9,99m <sup>2</sup>	10 - 99,99m <sup>2</sup>
1mm	41,40	40,20
2mm	63,30	62,40
3mm	85,20	84,60
4mm	107,10	106,80
5mm	129,10	129,00
6mm	151,00	151,20
7mm	172,90	173,50
8mm	194,80	195,70
9mm	216,70	217,90
10mm	244,10	245,20
11mm	266,00	267,40
12mm	287,90	289,60
13mm	309,80	311,80
14mm	331,80	334,00
15mm	353,70	356,20
16mm	375,60	378,40
18mm	419,40	422,80
20mm	488,20	490,30
25mm	597,80	601,40
30mm	707,30	712,40
40mm	926,40	934,50
50mm	1.145,50	1.156,60

PE-mikroporöse 60kg/m <sup>3</sup> 2000x1000mm - bunt		
tloušťka	Preis	
	1 - 9,99m <sup>2</sup>	10 - 99,99m <sup>2</sup>
1mm	43,60	34,80
2mm	67,60	54,10
3mm	91,70	73,30
4mm	115,70	92,60
5mm	139,80	111,80
6mm	163,90	131,10
7mm	187,90	150,30
8mm	212,00	169,60
9mm	236,00	188,80
10mm	265,60	212,50
11mm	289,60	231,70
12mm	313,70	251,00
13mm	337,80	270,20
14mm	361,80	289,50
15mm	385,90	308,70
16mm	409,90	328,00
18mm	458,10	366,40
20mm	531,20	424,90
25mm	651,50	521,20
30mm	771,80	617,40
40mm	1.012,40	809,90
50mm	1.252,90	1.002,40

PE-mikroporöse 100kg/m <sup>3</sup> 2000x1000mm - weiß + anthrazit		
Stärke	Preis	
	1 - 9,99m <sup>2</sup>	10 - 99,99m <sup>2</sup>
1mm	56,40	52,00
2mm	93,20	86,10
3mm	130,10	120,10
4mm	167,00	154,10
5mm	203,80	188,10
6mm	240,70	222,20
7mm	277,60	256,20
8mm	314,40	290,20
9mm	351,30	324,30
10mm	393,70	363,40
11mm	430,50	397,40
12mm	467,40	431,40
13mm	504,30	465,50
14mm	541,10	499,40
15mm	578,00	533,50
16mm	614,90	567,60
18mm	688,60	635,60
20mm	787,30	726,80
25mm	971,60	896,90
30mm	1.156,00	1.067,10
40mm	1.524,60	1.407,30
50mm	1.893,30	1.747,60

PE-mikroporöse 100kg/m <sup>3</sup> 2000x1000mm - bunt		
Stärke	Preis	
	1 - 9,99m <sup>2</sup>	10 - 99,99m <sup>2</sup>
1mm	60,00	55,40
2mm	100,50	92,70
3mm	140,90	130,10
4mm	181,40	167,50
5mm	221,90	204,80
6mm	262,40	242,20
7mm	302,90	279,60
8mm	343,30	316,90
9mm	383,80	354,30
10mm	429,80	396,70
11mm	470,30	434,10
12mm	510,80	471,50
13mm	551,20	508,80
14mm	591,70	546,20
15mm	632,20	583,60
16mm	672,70	620,90
18mm	753,60	695,70
20mm	859,60	793,50
25mm	1.062,00	980,30
30mm	1.264,40	1.167,10
40mm	1.669,20	1.540,80
50mm	2.074,00	1.914,50

PE-mikroporöse 120kg/m <sup>3</sup> 1890x930mm - weiß + anthrazit		
Stärke	Preis	
	1 - 9,99m <sup>2</sup>	10 - 99,99m <sup>2</sup>
1mm	65,40	60,30
2mm	103,90	95,90
3mm	157,10	145,00
4mm	202,90	187,30
5mm	248,80	229,70
6mm	294,70	272,00
7mm	340,50	314,30
8mm	386,40	356,70
9mm	432,30	399,00
10mm	483,60	446,40
11mm	529,50	488,70
12mm	575,30	531,10
13mm	621,20	573,40
14mm	667,10	615,70
15mm	712,90	658,10
16mm	758,80	700,40
18mm	850,50	785,10
20mm	967,20	892,80
25mm	1.196,50	1.104,50
30mm	1.425,80	1.316,20
40mm	1.884,50	1.739,50
50mm	2.343,10	2.162,80

PE-mikroporöse 120kg/m <sup>3</sup> 1890x930mm - bunt		
Stärke	Preis	
	1 - 9,99m <sup>2</sup>	10 - 99,99m <sup>2</sup>
1mm	69,90	64,50
2mm	112,20	103,60
3mm	170,60	157,50
4mm	220,90	203,90
5mm	271,30	250,40
6mm	321,60	296,90
7mm	372,00	343,40
8mm	422,40	389,90
9mm	472,70	436,40
10mm	528,60	487,90
11mm	578,90	534,40
12mm	629,30	580,90
13mm	679,70	627,40
14mm	730,00	673,90
15mm	780,40	720,30
16mm	830,70	766,80
18mm	931,40	859,80
20mm	1.057,20	975,80
25mm	1.309,00	1.208,30
30mm	1.560,70	1.440,70
40mm	2.064,30	1.905,50
50mm	2.567,90	2.370,40

PE-mikroporöse 200kg/m <sup>3</sup> 1650x830mm - weiß + anthrazit		
Stärke	Preis	
	1 - 9,99m <sup>2</sup>	10 - 99,99m <sup>2</sup>
1mm	85,10	78,50
2mm	150,60	139,00
3mm	216,20	199,60
4mm	281,80	260,10
5mm	347,30	320,60
6mm	412,90	381,10
7mm	478,50	441,70
8mm	544,00	502,20
9mm	609,60	562,70
10mm	680,60	628,30
11mm	746,20	688,80
12mm	811,80	749,30
13mm	877,30	809,90
14mm	942,90	870,40
15mm	1.008,50	930,90
16mm	1.074,00	991,40
18mm	1.205,20	1.112,50
20mm	1.361,30	1.256,60
25mm	1.689,10	1.559,20
30mm	2.016,90	1.861,80
40mm	2.672,60	2.467,00
50mm	3.328,20	3.072,20

PE-mikroporöse 200kg/m <sup>3</sup> 1650x830mm - bunt		
Stärke	Preis	
	1 - 9,99m <sup>2</sup>	10 - 99,99m <sup>2</sup>
1mm	91,50	84,50
2mm	163,50	150,90
3mm	235,50	217,40
4mm	307,50	283,80
5mm	379,50	350,30
6mm	451,50	416,70
7mm	523,50	483,20
8mm	595,50	549,70
9mm	667,50	616,10
10mm	745,00	687,70
11mm	817,00	754,10
12mm	889,00	820,60
13mm	960,90	887,00
14mm	1.032,90	953,50
15mm	1.104,90	1.019,90
16mm	1.176,90	1.086,40
18mm	1.320,90	1.219,30
20mm	1.489,90	1.375,30
25mm	1.849,90	1.707,360
30mm	2.209,90	2.039,90
40mm	2.929,80	2.704,50
50mm	3.649,80	3.369,00

## EVA-MIKROPORÖSE GUMMIPLATTEN

Mikroporöse Platte, geschlossene Poren mit ausgezeichneter Elastizität. **Farben:** schwarz, gelb, rot, blau, grün, hellgrau.

**Beständigkeit:** beständig gegen Witterungseinflüsse und UV-Strahlung.

EVA-mikroporöse 33kg/m <sup>3</sup> 2000x1000mm - bílá + antracit		
Stärke	Preis	
	1 - 9,99m <sup>2</sup>	10 - 99,99m <sup>2</sup>
1mm	32,50	30,00
2mm	45,50	42,00
3mm	58,40	54,00
4mm	71,40	65,90
5mm	84,40	77,90
6mm	97,40	89,90
7mm	110,40	101,90
8mm	123,40	113,90
9mm	136,30	125,90
10mm	154,80	142,90
11mm	167,80	154,90
12mm	180,80	166,90
13mm	193,80	178,90
14mm	206,80	190,90
15mm	219,70	202,80
16mm	232,70	214,80
18mm	258,70	238,80
20mm	309,70	285,80
25mm	374,60	345,80
30mm	439,50	405,70
40mm	569,30	525,50
50mm	699,10	654,40

EVA-mikroporöse 33kg/m <sup>3</sup> 2000x1000mm - bunt		
Stärke	Preis	
	1 - 9,99m <sup>2</sup>	10 - 99,99m <sup>2</sup>
1mm	33,70	31,10
2mm	48,00	44,30
3mm	62,20	57,40
4mm	76,50	70,60
5mm	90,70	83,70
6mm	104,90	96,90
7mm	119,20	110,00
8mm	133,40	123,20
9mm	147,70	136,30
10mm	167,40	154,50
11mm	181,60	167,70
12mm	195,90	180,80
13mm	210,10	193,90
14mm	224,40	207,10
15mm	238,60	220,20
16mm	252,80	233,40
18mm	281,30	259,70
20mm	334,80	309,00
25mm	406,00	374,80
30mm	477,20	440,50
40mm	619,60	570,90
50mm	762,00	703,40

EVA-mikroporöse 45kg/m <sup>3</sup> 2000x1000mm - bílá + antracit		
Stärke	Preis	
	1 - 9,99m <sup>2</sup>	10 - 99,99m <sup>2</sup>
1mm	36,20	33,40
2mm	52,80	48,80
3mm	69,50	64,20
4mm	86,20	79,60
5mm	102,90	95,00
6mm	119,50	110,40
7mm	136,20	125,70
8mm	152,90	141,10
9mm	169,60	156,50
10mm	191,70	177,00
11mm	208,40	192,40
12mm	225,10	207,80
13mm	241,80	223,20
14mm	258,40	238,60
15mm	275,10	254,00
16mm	291,80	269,30
18mm	325,10	300,10
20mm	383,50	354,00
25mm	466,90	431,00
30mm	550,20	507,90
40mm	717,00	661,80
50mm	883,70	815,80

EVA-mikroporöse 45kg/m <sup>3</sup> 2000x1000mm - bunt		
Stärke	Preis	
	1 - 9,99m <sup>2</sup>	10 - 99,99m <sup>2</sup>
1mm	37,80	34,90
2mm	56,10	51,80
3mm	74,40	68,70
4mm	92,70	85,60
5mm	111,00	102,50
6mm	129,30	119,30
7mm	147,60	136,20
8mm	165,90	153,10
9mm	184,20	170,00
10mm	208,00	192,00
11mm	226,30	208,90
12mm	244,60	225,80
13mm	262,90	242,70
14mm	281,20	259,60
15mm	299,50	276,50
16mm	317,80	293,30
18mm	354,40	327,10
20mm	416,00	384,00
25mm	507,50	468,40
30mm	599,00	552,90
40mm	782,00	721,80
50mm	965,00	890,70

EVA-mikroporöse 60kg/m <sup>3</sup> 2000x1000mm - bílá + antracit		
Stärke	Preis	
	1 - 9,99m <sup>2</sup>	10 - 99,99m <sup>2</sup>
1mm	43,60	40,20
2mm	67,60	62,40
3mm	91,70	84,60
4mm	115,70	106,80
5mm	139,80	129,00
6mm	163,90	151,20
7mm	187,90	173,50
8mm	212,00	195,70
9mm	236,00	217,90
10mm	265,60	245,20
11mm	289,60	267,40
12mm	313,70	289,60
13mm	337,80	311,80
14mm	361,80	334,00
15mm	385,90	356,20
16mm	409,90	378,40
18mm	458,10	422,80
20mm	531,20	490,30
25mm	651,50	601,40
30mm	771,80	712,40
40mm	1.012,40	934,50
50mm	1.252,90	1.156,60

EVA-mikroporöse 60kg/m <sup>3</sup> 2000x1000mm - bunt		
Stärke	Preis	
	1 - 9,99m <sup>2</sup>	10 - 99,99m <sup>2</sup>
1mm	45,90	42,40
2mm	72,30	66,80
3mm	98,80	91,20
4mm	125,20	115,60
5mm	151,60	139,90
6mm	178,00	164,30
7mm	204,50	188,70
8mm	230,90	213,10
9mm	257,30	237,50
10mm	289,20	267,00
11mm	315,60	291,40
12mm	342,10	315,70
13mm	368,50	340,10
14mm	394,90	364,50
15mm	421,30	388,90
16mm	447,70	413,30
18mm	500,60	462,10
20mm	578,40	533,90
25mm	710,50	655,90
30mm	842,70	777,80
40mm	1.106,90	1.021,70
50mm	1.371,10	1.265,60

EVA-mikroporöse 100kg/m <sup>3</sup> 2000x1000mm - weiß + anthrazit		
Stärke	Preis	
	1 - 9,99m <sup>2</sup>	10 - 99,99m <sup>2</sup>
1mm	58,70	54,20
2mm	98,00	90,40
3mm	137,20	126,60
4mm	176,40	162,90
5mm	215,70	199,10
6mm	254,90	235,30
7mm	294,10	271,50
8mm	333,40	307,70
9mm	372,60	343,90
10mm	417,30	385,20
11mm	456,60	421,50
12mm	495,80	457,70
13mm	535,00	493,90
14mm	574,30	530,10
15mm	613,50	566,30
16mm	652,80	602,50
18mm	731,20	675,00
20mm	834,70	770,50
25mm	1.030,90	951,60
30mm	1.227,00	1.132,60
40mm	1.619,40	1.494,80
50mm	2.011,70	1.857,00

EVA-mikroporöse 100kg/m <sup>3</sup> 2000x1000mm - bunt		
Stärke	Preis	
	1 - 9,99m <sup>2</sup>	10 - 99,99m <sup>2</sup>
1mm	62,60	57,80
2mm	105,70	97,50
3mm	148,80	137,30
4mm	191,90	177,10
5mm	234,90	216,90
6mm	278,00	256,60
7mm	321,10	296,40
8mm	364,20	336,20
9mm	407,30	376,00
10mm	455,90	420,80
11mm	499,00	460,60
12mm	542,10	500,40
13mm	585,10	540,10
14mm	628,20	579,90
15mm	671,30	619,70
16mm	714,40	659,90
18mm	800,60	739,00
20mm	911,80	841,60
25mm	1.127,20	1.040,50
30mm	1.342,60	1.239,40
40mm	1.773,50	1.637,10
50mm	2.204,40	2.034,80

EVA-mikroporöse 120kg/m <sup>3</sup> 1890x930mm - weiß + anthrazit		
Stärke	Preis	
	1 - 9,99m <sup>2</sup>	10 - 99,99m <sup>2</sup>
1mm	67,40	62,20
2mm	115,30	106,40
3mm	163,10	150,60
4mm	211,00	194,80
5mm	258,90	239,00
6mm	306,80	283,20
7mm	354,70	327,40
8mm	402,60	371,60
9mm	450,40	415,80
10mm	503,80	465,10
11mm	551,70	509,30
12mm	599,60	553,50
13mm	647,50	597,70
14mm	696,30	641,90
15mm	743,20	686,10
16mm	791,10	730,20
18mm	886,90	818,60
20mm	1.007,60	930,10
25mm	1.247,00	1.151,10
30mm	1.486,40	1.372,10
40mm	1.965,30	1.814,10
50mm	2.444,10	2.256,10

EVA-mikroporöse 120kg/m <sup>3</sup> 1890x930mm - bunt		
Stärke	Preis	
	1 - 9,99m <sup>2</sup>	10 - 99,99m <sup>2</sup>
1mm	72,10	66,50
2mm	124,70	115,10
3mm	177,30	163,60
4mm	229,80	212,20
5mm	282,40	260,70
6mm	335,00	309,30
7mm	387,60	357,80
8mm	440,20	406,30
9mm	492,80	454,90
10mm	550,90	508,50
11mm	603,50	557,00
12mm	656,00	605,60
13mm	708,60	654,10
14mm	761,20	702,70
15mm	813,80	751,20
16mm	866,40	799,80
18mm	971,60	896,80
20mm	1.101,70	1.017,00
25mm	1.364,70	1.259,70
30mm	1.627,60	1.502,40
40mm	2.153,50	1.987,80
50mm	2.679,40	2.473,30

EVA-mikroporöse 140kg/m <sup>3</sup> 1800x880mm - weiß + anthrazit		
Stärke	Preis	
	1 - 9,99m <sup>2</sup>	10 - 99,99m <sup>2</sup>
1mm	73,80	68,10
2mm	128,20	118,30
3mm	182,50	168,40
4mm	236,80	218,60
5mm	291,10	268,70
6mm	345,50	318,90
7mm	399,80	369,00
8mm	454,10	419,20
9mm	508,40	469,30
10mm	568,30	524,50
11mm	622,60	574,70
12mm	676,90	624,80
13mm	731,20	675,00
14mm	785,60	725,10
15mm	839,90	775,30
16mm	894,20	825,40
18mm	1.002,90	925,70
20mm	1.136,50	1.049,10
25mm	1.408,10	1.299,80
30mm	1.679,80	1.550,60
40mm	2.223,00	2.052,00
50mm	2.766,30	2.553,50

EVA-mikroporöse 140kg/m <sup>3</sup> 1800x880mm - bunt		
Stärke	Preis	
	1 - 9,99m <sup>2</sup>	10 - 99,99m <sup>2</sup>
1mm	79,20	73,10
2mm	138,80	128,10
3mm	198,50	183,20
4mm	258,10	238,30
5mm	317,80	293,30
6mm	377,40	348,40
7mm	437,10	403,50
8mm	496,80	458,50
9mm	556,40	513,60
10mm	621,60	573,80
11mm	681,20	628,80
12mm	740,90	683,90
13mm	800,50	739,00
14mm	860,20	794,00
15mm	919,80	849,10
16mm	979,50	904,20
18mm	1.098,80	1.014,30
20mm	1.243,10	1.147,50
25mm	1.541,40	1.422,80
30mm	1.839,70	1.698,20
40mm	2.436,30	2.248,80
50mm	3.032,80	2.799,50

EVA-mikroporöse 200kg/m <sup>3</sup> 1650x830mm - weiß + anthrazit		
Stärke	Preis	
	1 - 9,99m <sup>2</sup>	10 - 99,99m <sup>2</sup>
1mm	88,90	82,00
2mm	158,30	146,10
3mm	227,60	210,10
4mm	297,00	274,20
5mm	366,40	338,20
6mm	435,80	402,20
7mm	505,10	466,30
8mm	574,50	530,30
9mm	643,90	594,40
10mm	718,80	663,50
11mm	788,20	727,50
12mm	857,50	791,60
13mm	926,90	855,60
14mm	996,30	919,70
15mm	1.065,70	983,70
16mm	1.135,00	1.047,70
18mm	1.273,80	1.175,80
20mm	1.437,60	1.327,00
25mm	1.784,40	1.647,20
30mm	2.131,30	1.967,40
40mm	2.825,10	2.607,80
50mm	3.518,90	3.248,20

EVA-mikroporöse 200kg/m <sup>3</sup> 1650x830mm - bunt		
Stärke	Preis	
	1 - 9,99m <sup>2</sup>	10 - 99,99m <sup>2</sup>
1mm	95,70	88,30
2mm	171,90	158,70
3mm	248,10	229,00
4mm	324,30	299,30
5mm	400,50	369,70
6mm	476,70	440,00
7mm	552,90	510,30
8mm	629,10	580,70
9mm	705,30	651,00
10mm	786,90	726,40
11mm	863,10	796,70
12mm	939,30	867,10
13mm	1.015,50	937,40
14mm	1.091,70	1.007,70
15mm	1.167,90	1.078,10
16mm	1.244,10	1.148,40
18mm	1.396,50	1.289,10
20mm	1.573,90	1.452,80
25mm	1.954,90	1.804,50
30mm	2.335,80	2.156,20
40mm	3.097,80	2.859,50
50mm	3.859,70	3.562,80

EVA-mikroporöse 250kg/m <sup>3</sup> 1800x900mm - weiß + anthrazit		
Stärke	Preis	
	1 - 9,99m <sup>2</sup>	10 - 99,99m <sup>2</sup>
1mm	105,60	97,40
2mm	191,60	176,90
3mm	277,70	256,30
4mm	363,70	335,70
5mm	449,80	415,20
6mm	535,80	494,60
7mm	621,90	574,00
8mm	707,90	653,40
9mm	794,00	732,90
10mm	885,50	817,40
11mm	971,60	896,80
12mm	1.057,60	976,30
13mm	1.143,70	1.055,70
14mm	1.229,70	1.135,10
15mm	1.315,80	1.214,50
16mm	1.401,80	1.294,00
18mm	1.573,90	1.452,80
20mm	1.771,00	1.634,80
25mm	2.201,30	2.031,90
30mm	2.631,50	2.429,10
40mm	3.492,00	3.223,40

EVA-mikroporöse 250kg/m <sup>3</sup> 1800x900mm - bunt		
Stärke	Preis	
	1 - 9,99m <sup>2</sup>	10 - 99,99m <sup>2</sup>
1mm	114,00	105,30
2mm	208,60	192,50
3mm	303,10	279,80
4mm	397,60	367,00
5mm	492,20	454,30
6mm	586,70	541,60
7mm	681,20	628,80
8mm	775,80	716,10
9mm	870,30	803,30
10mm	970,30	895,70
11mm	1.064,80	982,90
12mm	1.159,40	1.070,20
13mm	1.253,90	1.157,50
14mm	1.348,40	1.244,70
15mm	1.443,00	1.332,00
16mm	1.537,50	1.419,20
18mm	1.726,60	1.593,80
20mm	1.940,60	1.791,40
25mm	2.413,30	2.227,70
30mm	2.885,90	2.664,00
40mm	3.831,30	3.536,60

EVA-mikroporöse 300kg/m <sup>3</sup> 1700x850mm - weiß + anthrazit		
Stärke	Preis	
	1 - 9,99m <sup>2</sup>	10 - 99,99m <sup>2</sup>
1mm	105,00	96,90
2mm	190,50	175,80
3mm	276,00	254,80
4mm	361,50	333,70
5mm	447,00	412,60
6mm	532,50	491,50
7mm	618,00	570,40
8mm	703,50	649,40
9mm	789,00	728,30
10mm	880,00	812,30
11mm	965,50	891,20
12mm	1.051,00	970,10
13mm	1.136,50	1.049,00
14mm	1.222,00	1.128,00
15mm	1.307,50	1.206,90
16mm	1.393,00	1.285,80
18mm	1.564,00	1.443,70
20mm	1.760,00	1.624,60
25mm	2.187,40	2.019,20
30mm	2.614,90	2.413,80
40mm	3.469,90	3.203,00

EVA-mikroporöse 300kg/m <sup>3</sup> 1700x850mm - bunt		
Stärke	Preis	
	1 - 9,99m <sup>2</sup>	10 - 99,99m <sup>2</sup>
1mm	113,40	104,70
2mm	207,30	191,40
3mm	301,20	278,00
4mm	395,10	364,70
5mm	489,00	451,40
6mm	582,90	538,10
7mm	676,80	624,70
8mm	770,70	711,40
9mm	864,60	798,10
10mm	964,00	889,80
11mm	1.057,90	976,50
12mm	1.151,80	1.063,20
13mm	1.245,70	1.149,90
14mm	1.339,60	1.236,50
15mm	1.433,50	1.323,20
16mm	1.527,40	1.409,90
18mm	1.715,20	1.583,30
20mm	1.928,00	1.779,70
25mm	2.397,50	2.213,10
30mm	2.867,00	2.646,40
40mm	3.806,00	3.513,20

# GUMMIPLATTEN

REGRANULAT

Eine recycelte Gummiplatte eignet sich für den Industrie- und Bauindustrie Bereich als Lärm-, Last und Schwingungsdämpfer.



In Industriehallen benutzt man sie als:

- Fußboden zum Ausgleich von Unebenheiten
- Kabelbrücken
- Unterlage unter Press- und Gussformen
- Unterlage unter Paletten gegen Verschiebung
- Unterlage als Abriebschutz zwischen einzelnen Produkten

Einschichtige Platten aus Gummigranulat bestehen aus zerkleinertem Reifengummi, der mit Polyurethan-Klebstoff verklebt wird.

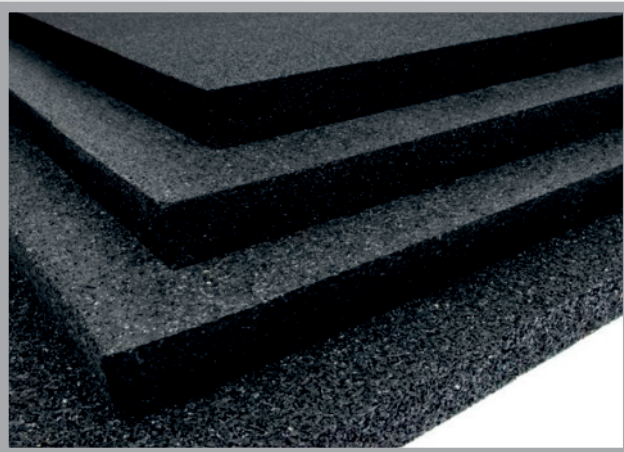
Die Eigenschaften des Materials ändern sich auch bei maximaler Lastbeanspruchung nicht.



ADIREG - regranulat		Preis		
 Stärke X Maß		0 - 12,49m <sup>2</sup>	12,5 - 99,99m <sup>2</sup>	100 - ....m <sup>2</sup>
tl. 3mm x 1.250x20.000mm		<b>104,53</b>	<b>87,11</b>	<b>80,41</b>
tl. 4mm x 1.250x15.000mm		<b>139,38</b>	<b>116,15</b>	<b>107,21</b>
tl. 5mm x 1.250x12.000mm		<b>146,22</b>	<b>121,85</b>	<b>112,48</b>
tl. 6mm x 1.250x10.000mm		<b>151,20</b>	<b>126,00</b>	<b>116,31</b>
tl. 8mm x 1.250x10.000mm		<b>200,36</b>	<b>166,96</b>	<b>154,12</b>
tl. 10mm x 1.250x6.000mm		<b>240,80</b>	<b>200,67</b>	<b>185,23</b>
tl. 12mm x 1.250x6.000mm		<b>291,20</b>	<b>242,67</b>	<b>224,00</b>
tl. 15mm x 1.150x2.300mm		<b>342,22</b>	<b>285,19</b>	<b>263,25</b>
tl. 20mm x 1.150x2.300mm		<b>494,67</b>	<b>412,22</b>	<b>380,51</b>
tl. 25mm x 1.000x2.000mm		<b>935,20</b>	<b>779,33</b>	<b>719,38</b>
tl. 30mm x 1.000x2.000mm		<b>1.074,08</b>	<b>895,07</b>	<b>826,22</b>
tl. 40mm x 1.000x2.000mm		<b>1.551,20</b>	<b>1.292,67</b>	<b>1.193,23</b>
tl. 50mm x 1.000x2.000mm		<b>1.826,72</b>	<b>1.522,27</b>	<b>1.405,17</b>
tl. 60mm x 1.000x2.000mm		<b>2.103,36</b>	<b>1.752,80</b>	<b>1.617,97</b>
tl. 64mm x 1.000x2.000mm		<b>2.213,12</b>	<b>1.844,27</b>	<b>1.702,40</b>



# GUMMIPLATTEN

REGRANULAT



...dichtet sofort

## Regranulierte PUZZLE-Platten.

Packung: Holzpaletten 1000x1000mm. Bei Bedarf erstellen wir Ihnen ein Preisangebot für den Versand, je nach Gewicht der Sendung und dem Lieferort. Mindestmenge für Sonderfarben – 50m<sup>2</sup>

Standardfarben mit Beimengungen von 10% EPDM haben wir auf Lager.

### Standardfarben:

- |  |   |   |
|--|---|---|
|  Rot RED 000 RAL 3016       |  Grün MAY GREEN 410 RAL 6017 |  Grau LIGHT GREY 380 RAL 7035 |
|  Blau SKY BLUE 180 RAL 5015 |  Gelb YELLOW 200 RAL 1012    |   |

### Sonderfarben:

- |  |  |   |
|--|--|---|
|  Orange ORANGE 550 RAL 2004 |  Sandgelb EARTH YELLOW 570 RAL 1011 |  Türkisblau TURQUOISE BLUE 540 RAL 5018 |
|  Blau TEAL 580 RAL 5024     |  Dunkelblau CAPRI BLUE 150 RAL 5019 |  Weiß PEARL 290 RAL 1013                |
|  Rosa ROSE 750 RAL 3017     |  Beige BEIGE 210 RAL 1001           |  Dunkelblau RAINBOW BLUE 590 RAL 5017   |
|  Braun BROWN 280 RAL 8024   |  Violett PURPLE 340 RAL 4005        |  Grasgrün RAINBOW GREEN 560 RAL 6025    |
|  Slate GREY RAL 7015        |  EGG SHELL RAL 1015                 |  BLACK RAL 9004                         |
|  RESEDA GREEN RAL 6011      |  Platina GREEN RAL 6000             |  Signal GREEN RAL 6032                  |
|  BLUE GREY 100 RAL 5014   |  |   |

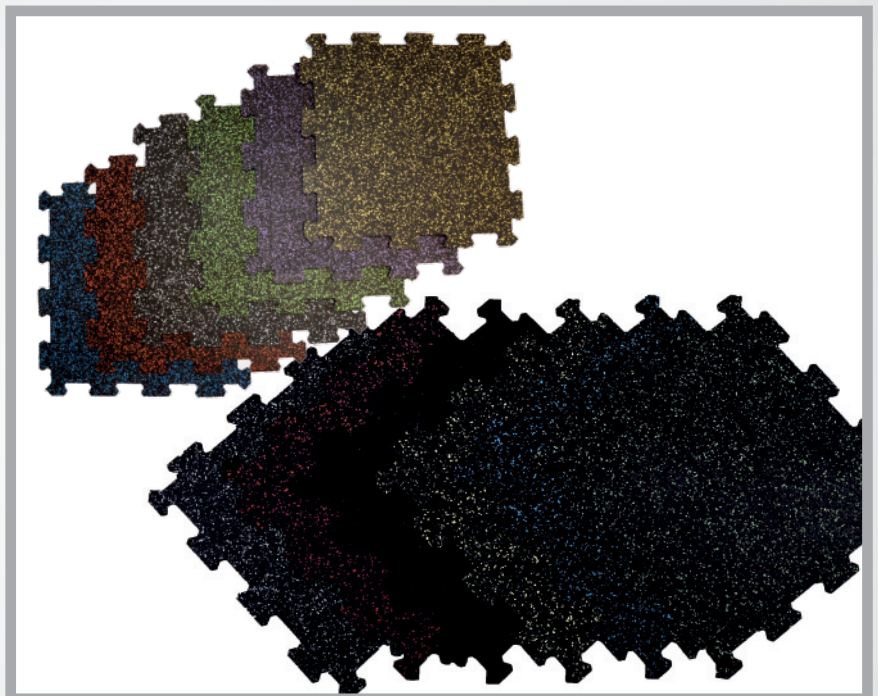
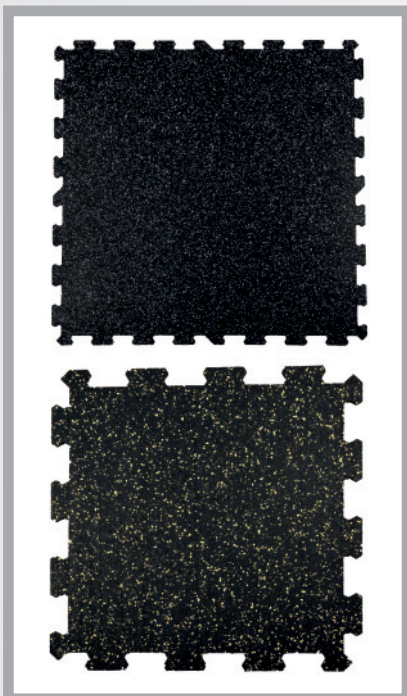



# GUMMIPLATTEN

REGRANULAT

GUMMIPLATTEN

PUZZLE SMALL - Regranulat		Preis			
SCHWARZ	Maß	0 - 9 ks	10 - 49 ks	50 - 99 ks	od 100 ks
ADIFLOOR PUZZLE ADI 1050	956x956x8mm	<b>449,87</b>	<b>415,26</b>	<b>385,60</b>	<b>359,89</b>
ADIFLOOR PUZZLE ADI 1050	956x956x10mm	<b>518,93</b>	<b>479,02</b>	<b>444,80</b>	<b>415,15</b>
ADIFLOOR PUZZLE ADI 1050	956x956x16mm	<b>804,53</b>	<b>742,65</b>	<b>689,60</b>	<b>643,63</b>
10% EPDM standard	Maß	0 - 9 ks	10 - 49 ks	50 - 99 ks	od 100 ks
ADIFLOOR PUZZLE ADI 1050	956x956x8mm	<b>567,47</b>	<b>523,82</b>	<b>486,40</b>	<b>453,97</b>
ADIFLOOR PUZZLE ADI 1050	956x956x10mm	<b>666,40</b>	<b>615,14</b>	<b>571,20</b>	<b>533,12</b>
ADIFLOOR PUZZLE ADI 1050	956x956x16mm	<b>1.039,73</b>	<b>959,75</b>	<b>891,20</b>	<b>831,79</b>
20% EPDM standard	Maß	0 - 9 ks	10 - 49 ks	50 - 99 ks	od 100 ks
ADIFLOOR PUZZLE ADI 1050	956x956x8mm	<b>688,80</b>	<b>635,82</b>	<b>590,40</b>	<b>551,04</b>
ADIFLOOR PUZZLE ADI 1050	956x956x10mm	<b>817,60</b>	<b>754,71</b>	<b>700,80</b>	<b>654,08</b>
ADIFLOOR PUZZLE ADI 1050	956x956x16mm	<b>1.282,40</b>	<b>1.183,75</b>	<b>1.099,20</b>	<b>1.025,92</b>
40% EPDM standard	Maß	0 - 9 ks	10 - 49 ks	50 - 99 ks	od 100 ks
ADIFLOOR PUZZLE ADI 1050	956x956x8mm	<b>938,93</b>	<b>866,71</b>	<b>804,80</b>	<b>751,15</b>
ADIFLOOR PUZZLE ADI 1050	956x956x10mm	<b>1.129,33</b>	<b>1.042,46</b>	<b>968,00</b>	<b>903,47</b>
ADIFLOOR PUZZLE ADI 1050	956x956x16mm	<b>1.780,80</b>	<b>1.643,82</b>	<b>1.526,40</b>	<b>1.424,64</b>

PUZZLE SMALL - Regranulat		Preis			
SCHWARZ	Maß	0 - 9 ks	10 - 49 ks	50 - 99 ks	od 100 ks
ADIFLOOR PUZZLE ADI 1050	478x478x8mm	<b>117,60</b>	<b>108,55</b>	<b>100,80</b>	<b>94,08</b>
ADIFLOOR PUZZLE ADI 1050	478x478x10mm	<b>136,27</b>	<b>125,78</b>	<b>116,80</b>	<b>109,01</b>
ADIFLOOR PUZZLE ADI 1050	478x478x16mm	<b>207,20</b>	<b>191,26</b>	<b>177,60</b>	<b>165,76</b>
10% EPDM standard	Maß	0 - 9 ks	10 - 49 ks	50 - 99 ks	od 100 ks
ADIFLOOR PUZZLE ADI 1050	478x478x8mm	<b>147,47</b>	<b>136,12</b>	<b>126,40</b>	<b>117,97</b>
ADIFLOOR PUZZLE ADI 1050	478x478x10mm	<b>171,73</b>	<b>158,52</b>	<b>147,20</b>	<b>137,39</b>
ADIFLOOR PUZZLE ADI 1050	478x478x16mm	<b>265,07</b>	<b>244,68</b>	<b>227,20</b>	<b>212,05</b>
20% EPDM standard	Maß	0 - 9 ks	10 - 49 ks	50 - 99 ks	od 100 ks
ADIFLOOR PUZZLE ADI 1050	478x478x8mm	<b>179,20</b>	<b>165,42</b>	<b>153,60</b>	<b>143,36</b>
ADIFLOOR PUZZLE ADI 1050	478x478x10mm	<b>210,93</b>	<b>194,71</b>	<b>180,80</b>	<b>168,75</b>
ADIFLOOR PUZZLE ADI 1050	478x478x16mm	<b>326,67</b>	<b>301,54</b>	<b>280,00</b>	<b>261,33</b>
40% EPDM standard	rozměr	0 - 9 ks	10 - 49 ks	50 - 99 ks	od 100 ks
ADIFLOOR PUZZLE ADI 1050	478x478x8mm	<b>240,80</b>	<b>222,28</b>	<b>206,40</b>	<b>192,64</b>
ADIFLOOR PUZZLE ADI 1050	478x478x10mm	<b>287,47</b>	<b>265,35</b>	<b>246,40</b>	<b>229,97</b>
ADIFLOOR PUZZLE ADI 1050	478x478x16mm	<b>451,73</b>	<b>416,98</b>	<b>387,20</b>	<b>361,39</b>

# GUMMIPLATTEN

REGRANULAT



...dichtet sofort

## Fallschutzmatten und Komponenten für Spielplätze

Bei den angegebenen Maßen handelt es sich um einen Richtwert, die Platten ziehen sich ca. 2% zusammen.  
 Alle Spielplatz-Platten und elastische Platten mit einem Raster von 15mm stellen wir auch in den Maßen 400x400mm, 500x1000mm, 600x600mm a 600x1200mm her. Preise für 1m<sup>2</sup>  
 Entsprechen den Preisen für die Größe 500x500mm.  
 Diese Produkte bieten wir auch in der Farbe anthrazit-grau und dunkelbraun zu dem Preis von „Grün“ an.

nr.	Produkt	Maß	code ADITEG	farbe	Fallhöhe nach EN 1177*	Preis			
						0 - 9 m <sup>2</sup>	10 - 49 m <sup>2</sup>	50 - 99 m <sup>2</sup>	od 100 m <sup>2</sup>
1	Fallschutzmatte für Spielplätze glatt Stärke 20mm	500x500x20 glatt	ADI1-20-0300-00	● schwarz	0,60	634,00	592,00	555,00	523,00
			ADI1-20-0301-00	● rot		685,00	639,00	599,00	564,00
			ADI1-20-0302-00	● grün		733,00	684,00	651,00	604,00
	Fallschutzmatte für Spielplätze Stärke 25mm und 30mm mit eingepressten Löchern	500x500x25 raster 15mm	ADI1-25-0300-15	● schwarz	0,90	634,00	592,00	555,00	523,00
			ADI1-25-0301-15	● rot		685,00	639,00	599,00	564,00
			ADI1-25-0302-15	● grün		733,00	684,00	641,00	604,00
		1000 x1000x25 raster 15mm	ADI3-25-0300-15	● schwarz	0,90	634,00	592,00	555,00	523,00
			ADI3-25-0301-15	● rot		685,00	639,00	599,00	564,00
			ADI3-25-0302-15	● grün		733,00	684,00	641,00	604,00
	500x500x30 glatt	500x500x30 glatt	ADI1-30-0300-00	● schwarz	0,90	886,00	827,00	775,00	730,00
			ADI1-30-0301-00	● rot		960,00	896,00	840,00	791,00
			ADI1-30-0302-00	● grün		1.022,00	954,00	895,00	842,00
	1000x1000x30 glatt	1000x1000x30 glatt	ADI3-30-0300-00	● schwarz	0,90	886,00	827,00	775,00	730,00
			ADI3-30-0301-00	● rot		960,00	896,00	840,00	791,00
			ADI3-30-0302-00	● grün		1.022,00	954,00	895,00	842,00
	500x500x30 raster 15mm	500x500x30 raster 15mm	ADI1-30-0300-15	● schwarz	1,10	784,00	731,00	686,00	645,00
			ADI1-30-0301-15	● rot		837,00	781,00	732,00	689,00
			ADI1-30-0302-15	● grün		895,00	836,00	783,00	737,00
	1000x1000x30 raster 15mm	1000x1000x30 raster 15mm	ADI3-30-0300-15	● schwarz	1,10	784,00	731,00	686,00	645,00
			ADI3-30-0301-15	● rot		837,00	781,00	732,00	689,00
			ADI3-30-0302-15	● grün		895,00	836,00	783,00	737,00
	500x500x30 raster 18mm	500x500x30 raster 18mm	ADI1-30-0300-18	● schwarz	1,00	681,00	636,00	596,00	561,00
			ADI1-30-0301-18	● rot		730,00	682,00	639,00	602,00
			ADI1-30-0302-18	● grün		773,00	722,00	677,00	637,00
2	Fallschutzmatte für Spielplätze Stärke 40mm mit eingepressten Löchern	500x500x40 raster 15mm	ADI1-40-0300-15	● schwarz	1,30	1.070,00	999,00	937,00	882,00
			ADI1-40-0301-15	● rot		1.129,00	1.054,00	988,00	930,00
			ADI1-40-0302-15	● grün		1.187,00	1.108,00	1.039,00	978,00
		1000x1000x40 raster 15mm	ADI3-40-0300-15	● schwarz	1,30	1.070,00	999,00	937,00	882,00
			ADI3-40-0301-15	● rot		1.129,00	1.054,00	988,00	930,00
			ADI3-40-0302-15	● grün		1.187,00	1.108,00	1.039,00	978,00
	500x500x40 raster 28mm	500x500x40 raster 28mm	ADI1-40-0300-28	● schwarz	1,30	846,00	790,00	740,00	697,00
			ADI1-40-0301-28	● rot		891,00	832,00	780,00	734,00
			ADI1-40-0302-28	● grün		959,00	895,00	839,00	790,00
	1000x1000x40 raster 28mm	1000x1000x40 raster 28mm	ADI3-40-0300-28	● schwarz	1,30	846,00	790,00	740,00	697,00
			ADI3-40-0301-28	● rot		891,00	832,00	780,00	734,00
			ADI3-40-0302-28	● grün		959,00	895,00	839,00	790,00

Gummiplatten – Regranulat					Fallhöhe nach EN 1177*	Preis					
nr.	Produkt	Maß	code ADITEG	fa"rbe		0 - 9 m <sup>2</sup>	10 - 49 m <sup>2</sup>	50 - 99 m <sup>2</sup>	od 100 m <sup>2</sup>		
3	Fallschutzmatte für Spielplätze Stärke 45mm mit eingepressten Löchern	500x500x45 raster 15mm	AD11-45-0300-15	● schwarz	1,50	1.187,00	1.108,00	1.039,00	978,00		
			AD11-45-0301-15	● rot		1.265,00	1.181,00	1.107,00	1.042,00		
			AD11-45-0302-15	● grün		1.275,00	1.190,00	1.116,00	1.050,00		
		1000x1000x45 raster 15mm	AD13-45-0300-15	● schwarz	1,50	1.187,00	1.108,00	1.039,00	978,00		
			AD13-45-0301-15	● rot		1.265,00	1.181,00	1.107,00	1.042,00		
			AD13-45-0302-15	● grün		1.275,00	1.190,00	1.116,00	1.050,00		
		500x500x45 raster BIG	AD11-45-0300-25 BIG	● schwarz	1,40	1.214,00	1.133,00	1.063,00	1.000,00		
			AD11-45-0301-25 BIG	● rot		1.316,00	1.228,00	1.151,00	1.083,00		
			AD11-45-0302-25 BIG	● grün		1.390,00	1.297,00	1.216,00	1.144,00		
		500x500x45 raster 28mm	AD11-45-0300-28	● schwarz	1,50	947,00	884,00	829,00	780,00		
			AD11-45-0301-28	● rot		987,00	922,00	864,00	813,00		
			AD11-45-0302-28	● grün		1.037,00	968,00	907,00	854,00		
		1000x1000x45 raster 28mm	AD13-45-0300-28	● schwarz	1,50	947,00	884,00	829,00	780,00		
			AD13-45-0301-28	● rot		987,00	922,00	864,00	813,00		
			AD13-45-0302-28	● grün		1.037,00	968,00	907,00	854,00		
		4	Fallschutzmatte für Spielplätze Stärke 50mm mit eingepressten Löchern	500x500x50 raster 15mm	AD11-50-0300-15	● schwarz	1,40	1.246,00	1.163,00	1.090,00	1.026,00
					AD11-50-0301-15	● rot		1.304,00	1.217,00	1.141,00	1.074,00
					AD11-50-0302-15	● grün		1.362,00	1.272,00	1.192,00	1.122,00
1000x1000x50 raster 15mm	AD13-50-0300-15			● schwarz	1,40	1.246,00	1.163,00	1.090,00	1.026,00		
	AD13-50-0301-15			● rot		1.304,00	1.217,00	1.141,00	1.074,00		
	AD13-50-0302-15			● grün		1.362,00	1.272,00	1.192,00	1.122,00		
500x500x50 raster BIG	AD11-50-0300-25 BIG			● schwarz	1,50	1.327,00	1.239,00	1.161,00	1.039,00		
	AD11-50-0301-25 BIG			● rot		1.438,00	1.342,00	1.258,00	1.184,00		
	AD11-50-0302-25 BIG			● grün		1.518,00	1.417,00	1.328,00	1.250,00		
500x500x50 raster 28mm	AD11-50-0300-28			● schwarz	1,70	1.096,00	1.023,00	959,00	902,00		
	AD11-50-0301-28			● rot		1.201,00	1.121,00	1.051,00	989,00		
	AD11-50-0302-28			● grün		1.270,00	1.186,00	1.111,00	1.046,00		
1000x1000x50 raster 28mm	AD13-50-0300-28			● schwarz	1,70	1.109,00	1.035,00	971,00	914,00		
	AD13-50-0301-28			● rot		1.201,00	1.121,00	1.051,00	989,00		
	AD13-50-0302-28			● grün		1.270,00	1.186,00	1.111,00	1.046,00		
5	Fallschutzmatte für Spielplätze Stärke 55mm, 65mm a 75mm mit eingepressten Löchern			500x500x55 raster 15mm	AD11-55-0300-15	● schwarz	1,50	1.436,00	1.341,00	1.257,00	1.183,00
					AD11-55-0301-15	● rot		1.557,00	1.453,00	1.362,00	1.282,00
					AD11-55-0302-15	● grün		1.644,00	1.534,00	1.438,00	1.354,00
		500x500x55 raster 28mm	AD11-55-0300-28	● schwarz	1,70	1.275,00	1.190,00	1.116,00	1.050,00		
			AD11-55-0301-28	● rot		1.382,00	1.290,00	1.209,00	1.138,00		
			AD11-55-0302-28	● grün		1.460,00	1.362,00	1.277,00	1.202,00		
		500x500x65 raster 28mm	AD11-65-0300-28	● schwarz	1,90	1.800,00	1.680,00	1.575,00	1.482,00		
			AD11-65-0301-28	● rot		1.923,00	1.795,00	1.683,00	1.584,00		
			AD11-65-0302-28	● grün		1.936,00	1.807,00	1.694,00	1.594,00		
		500x500x65 raster 50mm	AD11-65-7500-50	● schwarz	2,30	1.656,00	1.545,00	1.449,00	1.363,00		
			AD11-65-7501-50	● rot		1.732,00	1.617,00	1.516,00	1.426,00		
			AD11-65-7502-50	● grün		1.848,00	1.724,00	1.617,00	1.522,00		
		1000x1000x65 raster 50mm	AD13-65-7500-50	● schwarz	2,30	1.656,00	1.545,00	1.449,00	1.363,00		
			AD13-65-7501-50	● rot		1.732,00	1.616,00	1.515,00	1.426,00		
			AD13-65-7502-50	● grün		1.848,00	1.725,00	1.617,00	1.522,00		
		500x500x75 raster 50mm	AD11-75-7500-50	● schwarz	2,40	2.330,00	2.175,00	2.039,00	1.919,00		
			AD11-75-7501-50	● rot		2.391,00	2.232,00	2.092,00	1.969,00		
			AD11-75-7502-50	● grün		2.582,00	2.410,00	2.259,00	2.126,00		

# GUMMIPLATTEN

REGRANULAT



GUMMIPLATTEN

Gummiplatten – Regranulat					Fallhöhe nach EN 1177*	Preis					
nr.	Produkt	Maß	code ADITEG	farbe		0 - 9 m²	10 - 49 m²	50 - 99 m²	od 100 m²		
6	Fallschutzmatte für Spielplätze Stärke 80mm	500x500x80 raster 15mm	ADI1-80-0300-15	● schwarz	1,70	2.254,00	2.103,00	1.972,00	1.856,00		
			ADI1-80-0301-15	● rot		2.310,00	2.156,00	2.021,00	1.902,00		
			ADI1-80-0302-15	● grün		2.496,00	2.330,00	2.184,00	2.056,00		
			500x500x80 raster 28mm	ADI1-80-0300-28	● schwarz	1,90	2.077,00	1.939,00	1.818,00	1.711,00	
				ADI1-80-0301-28	● rot		2.219,00	2.071,00	1.941,00	1.827,00	
				ADI1-80-0302-28	● grün		2.332,00	2.176,00	2.040,00	1.920,00	
		500x500x80 raster 50mm	ADI1-80-0300-50	● schwarz	2,40	1.846,00	1.723,00	1.615,00	1.520,00		
			ADI1-80-0301-50	● rot		1.945,00	1.815,00	1.702,00	1.602,00		
			ADI1-80-0302-50	● grün		2.017,00	1.882,00	1.762,00	1.661,00		
		1000x1000x80 raster 50mm	ADI3-80-0300-50	● schwarz	2,40	1.846,00	1.723,00	1.615,00	1.520,00		
			ADI3-80-0301-50	● rot		1.945,00	1.815,00	1.702,00	1.602,00		
			ADI3-80-0302-50	● grün		2.017,00	1.882,00	1.765,00	1.661,00		
7	Fallschutzmatte für Spielplätze Stärke 90mm	500x500x90 raster BIG	ADI1-90-0300-25 BIG	● schwarz	1,70	3.229,00	3.014,00	2.826,00	2.660,00		
			ADI1-90-0301-25 BIG	● rot		3.424,00	3.196,00	2.993,00	2.820,00		
			ADI1-90-0302-25 BIG	● grün		3.580,00	3.341,00	3.132,00	2.948,00		
		500x500x90 raster 28mm	ADI1-90-0300-28	● schwarz	2,20	2.982,00	2.783,00	2.609,00	2.455,00		
			ADI1-90-0301-28	● rot		3.162,00	2.951,00	2.767,00	2.604,00		
			ADI1-90-0302-28	● grün		3.309,00	3.088,00	2.895,00	2.725,00		
8	Fallschutzmatte für Spielplätze Stärke 100mm	500x500x100 raster 28mm	ADI1-00-0300-28	● schwarz	2,00	2.769,00	2.584,00	2.423,00	2.280,00		
			ADI1-00-0301-28	● rot		2.919,00	2.725,00	2.554,00	2.404,00		
			ADI1-00-0302-28	● grün		3.031,00	2.829,00	2.652,00	2.496,00		
		500x500x100 raster 50mm	ADI1-00-0300-50	● schwarz	2,80	2.307,00	2.153,00	2.019,00	1.900,00		
			ADI1-00-0301-50	● rot		2.433,00	2.271,00	2.129,00	2.003,00		
			ADI1-00-0302-50	● grün		2.524,00	2.355,00	2.208,00	2.078,00		
		500x500x100 raster 75mm	ADI1-00-0300-75	● schwarz	3,00	1.927,00	1.798,00	1.686,00	1.587,00		
			ADI1-00-0301-75	● rot		1.989,00	1.856,00	1.740,00	1.638,00		
			ADI1-00-0302-75	● grün		2.063,00	1.925,00	1.805,00	1.699,00		
		9	Randplatte Stärke 30mm	500x500x30 glatt	ADI-K1-30-0300-00	● schwarz		1.265,00	1.181,00	1.107,00	1.042,00
					ADI-K1-30-0301-00	● rot		1.313,00	1.226,00	1.149,00	1.081,00
					ADI-K1-30-0302-00	● grün		1.357,00	1.267,00	1.188,00	1.118,00
Eckplatte Stärke 30mm	500x500x30 glatt		ADI-R1-30-0300-00	● schwarz		1.226,00	1.144,00	1.073,00	1.010,00		
			ADI-R1-30-0301-00	● rot		1.270,00	1.186,00	1.111,00	1.046,00		
			ADI-R1-30-0302-00	● grün		1.313,00	1.226,00	1.149,00	1.081,00		
Halbplatte Stärke 30mm	500x250x30 raster 15mm		ADI1/2-30-0300-15	● schwarz		900,00	840,00	788,00	742,00		
			ADI1/2-30-0301-15	● rot		963,00	899,00	842,00	793,00		
			ADI1/2-30-0302-15	● grün		1.030,00	962,00	901,00	848,00		
10	Randplatte Stärke 40mm	500x500x40 glatt	ADI-K1-40-0300-00	● schwarz		1.543,00	1.440,00	1.350,00	1.270,00		
			ADI-K1-40-0301-00	● rot		1.596,00	1.490,00	1.396,00	1.314,00		
			ADI-K1-40-0302-00	● grün		1.650,00	1.540,00	1.444,00	1.359,00		
	Eckplatte Stärke 40mm	500x250x40 glatt	ADI-R1-40-0300-00	● schwarz		1.455,00	1.358,00	1.273,00	1.198,00		
			ADI-R1-40-0301-00	● rot		1.508,00	1.407,00	1.319,00	1.242,00		
			ADI-R1-40-0302-00	● grün		1.557,00	1.453,00	1.362,00	1.282,00		
	Halbplatte Stärke 40mm	500x250x40 raster 28mm	ADI1/2-40-0300-28	● schwarz		973,00	908,00	851,00	801,00		
			ADI1/2-40-0301-28	● rot		1.025,00	957,00	897,00	844,00		
			ADI1/2-40-0302-28	● grün		1.103,00	1.029,00	965,00	908,00		

Gummiplatten – Regranulat					Preis			
nr.	Produkt	Maß	code ADITEG	farbe	0 – 9 m <sup>2</sup>	10 – 49 m <sup>2</sup>	50 – 99 m <sup>2</sup>	od 100 m <sup>2</sup>
11	Randplatte Stärke 45mm	500x500x45 glatt	ADI-K1-45-0300-00	● schwarz	1.791,00	1.671,00	1.567,00	1.475,00
			ADI-K1-45-0301-00	● rot	1.854,00	1.731,00	1.622,00	1.527,00
			ADI-K1-45-0302-00	● grün	1.913,00	1.785,00	1.673,00	1.575,00
	Eckplatte Stärke 45mm	500x500x45 glatt	ADI-R1-45-0300-00	● schwarz	1.709,00	1.595,00	1.495,00	1.407,00
			ADI-R1-45-0301-00	● rot	1.765,00	1.647,00	1.544,00	1.453,00
			ADI-R1-45-0302-00	● grün	1.823,00	1.701,00	1.595,00	1.501,00
	Halbplatte Stärke 45mm	500x250x45 raster 28mm	ADI1/2-45-0300-28	● schwarz	1.090,00	1.017,00	954,00	898,00
			ADI1/2-45-0301-28	● rot	1.137,00	1.061,00	995,00	936,00
			ADI1/2-45-0302-28	● grün	1.191,00	1.112,00	1.042,00	981,00
12	Randplatte Stärke 50mm	500x500x50 glatt	ADI-K1-50-0300-00	● schwarz	1.874,00	1.749,00	1.639,00	1.543,00
			ADI-K1-50-0301-00	● rot	1.936,00	1.807,00	1.694,00	1.594,00
			ADI-K1-50-0302-00	● grün	1.999,00	1.866,00	1.750,00	1.647,00
	Eckplatte Stärke 50mm	500x500x50 glatt	ADI-R1-50-0300-00	● schwarz	1.709,00	1.595,00	1.495,00	1.407,00
			ADI-R1-50-0301-00	● rot	1.766,00	1.648,00	1.545,00	1.454,00
			ADI-R1-50-0302-00	● grün	1.824,00	1.703,00	1.596,00	1.502,00
	Halbplatte Stärke 50mm	500x250x50 raster 28mm	ADI1/2-50-0300-28	● schwarz	1.277,00	1.192,00	1.117,00	1.051,00
			ADI1/2-50-0301-28	● rot	1.380,00	1.288,00	1.208,00	1.137,00
			ADI1/2-50-0302-28	● grün	1.461,00	1.364,00	1.278,00	1.203,00
13	Randplatte Stärke 55mm	500x500x55 glatt	ADI-K1-55-0300-00	● schwarz	2.082,00	1.944,00	1.822,00	1.715,00
			ADI-K1-55-0301-00	● rot	2.155,00	2.011,00	1.886,00	1.775,00
			ADI-K1-55-0302-00	● grün	2.224,00	2.076,00	1.946,00	1.831,00
	Eckplatte Stärke 45mm	500x500x55 hladká	ADI-R1-55-0300-00	● schwarz	1.976,00	1.844,00	1.729,00	1.627,00
			ADI-R1-55-0301-00	● rot	2.044,00	1.907,00	1.788,00	1.683,00
			ADI-R1-55-0302-00	● grün	2.112,00	1.972,00	1.848,00	1.740,00
	Halbplatte Stärke 55mm	500x250x55 raster 28mm	ADI1/2-55-0300-28	● schwarz	1.466,00	1.368,00	1.283,00	1.207,00
			ADI1/2-55-0301-28	● rot	1.588,00	1.482,00	1.390,00	1.308,00
			ADI1/2-55-0302-28	● grün	1.684,00	1.572,00	1.474,00	1.387,00
14	Randplatte Stärke 65mm	500x500x65 glatt	ADI-K1-65-0300-00	● schwarz	2.333,00	2.178,00	2.042,00	1.922,00
			ADI-K1-65-0301-00	● rot	2.121,00	1.980,00	1.856,00	1.747,00
			ADI-K1-65-0302-00	● grün	2.195,00	2.049,00	1.921,00	1.808,00
	Eckplatte Stärke 65mm	500x500x65 glatt	ADI-R1-65-0300-00	● schwarz	2.121,00	1.980,00	1.856,00	1.747,00
			ADI-R1-65-0301-00	● rot	2.195,00	2.049,00	1.921,00	1.808,00
			ADI-R1-65-0302-00	● grün	2.225,00	2.077,00	1.947,00	1.832,00
	Halbplatte Stärke 65mm	500x250x65 raster 28mm	ADI1/2-65-0300-28	● schwarz	2.071,00	1.933,00	1.812,00	1.705,00
			ADI1/2-65-0301-28	● rot	2.211,00	2.064,00	1.935,00	1.821,00
			ADI1/2-65-0302-28	● grün	2.226,00	2.078,00	1.948,00	1.833,00
Eckplatte Stärke 65mm	500x500x65 raster 50mm	ADI1/2-65-0300-50	● schwarz	1.905,00	1.778,00	1.667,00	1.569,00	
		ADI1/2-65-0301-50	● rot	1.990,00	1.858,00	1.742,00	1.639,00	
		ADI1/2-65-0302-50	● grün	2.125,00	1.984,00	1.860,00	1.750,00	
15	Randplatte Stärke 80mm	500x500x80 glatt	ADI-K1-80-0300-00	● schwarz	2.787,00	2.601,00	2.439,00	2.295,00
			ADI-K1-80-0301-00	● rot	2.886,00	2.693,00	2.525,00	2.376,00
			ADI-K1-80-0302-00	● grün	2.982,00	2.783,00	2.609,00	2.455,00
	Eckplatte Stärke 80mm	500x500x80 glatt	ADI-R1-80-0300-00	● schwarz	2.394,00	2.234,00	2.095,00	1.971,00
			ADI-R1-80-0301-00	● rot	2.477,00	2.31200	2.167,00	2.040,00
			ADI-R1-80-0302-00	● grün	2.544,00	2.375,00	2.226,00	2.095,00
	Halbplatte Stärke 80mm	500x250x80 raster 50mm	ADI1/2-80-0300-50	● schwarz	1.998,00	1.865,00	1.748,00	1.646,00
			ADI1/2-80-0301-50	● rot	2.104,00	1.964,00	1.841,00	1.733,00
			ADI1/2-80-0302-50	● grün	2.182,00	2.037,00	1.910,00	1.797,00

# GUMMIPLATTEN

REGRANULAT



GUMMIPLATTEN

Gummiplatten – Regranulat					Preis			
nr.	Produkt	Maß	code ADITEG	farbe	0 - 9 m <sup>2</sup>	10 - 49 m <sup>2</sup>	50 - 99 m <sup>2</sup>	od 100 m <sup>2</sup>
16	Randplatte Stärke 90mm	500x500x90 glatt	ADI-K1-90-0300-00	● schwarz	3.017,00	2.816,00	2.640,00	2.484,00
			ADI-K1-90-0301-00	● rot	3.118,00	2.910,00	2.728,00	2.568,00
			ADI-K1-90-0302-00	● grün	3.226,00	3.011,00	2.822,00	2.656,00
	Eckplatte Stärke 90mm	500x500x90 glatt	ADI-R1-90-0300-00	● schwarz	2.496,00	2.330,00	2.184,00	2.056,00
			ADI-R1-90-0301-00	● rot	2.582,00	2.410,00	2.259,00	2.126,00
			ADI-R1-90-0302-00	● grün	2.672,00	2.493,00	2.338,00	2.200,00
17	Randplatte Stärke 100mm	500x500x100 glatt	ADI-K1-00-0300-00	● schwarz	3.328,00	3.106,00	2.912,00	2.741,00
			ADI-K1-00-0301-00	● rot	3.445,00	3.215,00	3.014,00	2.837,00
			ADI-K1-00-0302-00	● grün	3.562,00	3.324,00	3.116,00	2.933,00
	Eckplatte Stärke 100mm	500x500x100 glatt	ADI-R1-00-0300-00	● schwarz	2.870,00	2.679,00	2.511,00	2.364,00
			ADI-R1-00-0301-00	● rot	2.973,00	2.774,00	2.601,00	2.448,00
			ADI-R1-00-0302-00	● grün	3.071,00	2.866,00	2.687,00	2.529,00
	Halbplatte Stärke 100mm	500x250x100 raster 75mm	ADI1/2-00-0300-75	● schwarz	2.216,00	2.068,00	1.939,00	1.825,00
			ADI1/2-00-0301-75	● rot	2.286,00	2.134,00	2.000,00	1.883,00
			ADI1/2-00-0302-75	● grün	2.372,00	2.214,00	2.075,00	1.953,00
18	Rampe zur Fallschutzmatte für Spielplätze	750x300x20	ADIN-20-0300-NA	● schwarz	250,00	233,00	219,00	206,00
			ADIN-20-0301-NA	● rot	262,00	245,00	229,00	216,00
			ADIN-20-0302-NA	● grün	274,00	256,00	240,00	226,00
		750x300x25	ADIN-25-0300-NA	● schwarz	300,00	280,00	262,00	247,00
			ADIN-25-0301-NA	● rot	315,00	294,00	275,00	259,00
			ADIN-25-0302-NA	● grün	329,00	307,00	288,00	271,00
		750x300x30	ADIN-30-0300-NA	● schwarz	350,00	326,00	306,00	288,00
			ADIN-30-0301-NA	● rot	367,00	342,00	321,00	302,00
			ADIN-30-0302-NA	● grün	384,00	358,00	336,00	316,00
	750x300x35	ADIN-35-0300-NA	● schwarz	395,00	368,00	345,00	325,00	
		ADIN-35-0301-NA	● rot	414,00	386,00	362,00	341,00	
		ADIN-35-0302-NA	● grün	433,00	404,00	379,00	357,00	
	750x300x40	ADIN-40-0300-NA	● schwarz	422,00	394,00	369,00	347,00	
		ADIN-40-0301-NA	● rot	445,00	415,00	389,00	366,00	
		ADIN-40-0302-NA	● grün	466,00	435,00	408,00	384,00	
	750x300x45	ADIN-45-0300-NA	● schwarz	464,00	433,00	406,00	382,00	
		ADIN-45-0301-NA	● rot	489,00	457,00	428,00	406,00	
		ADIN-45-0302-NA	● grün	514,00	480,00	450,00	423,00	
	750x300x50	ADIN-50-0300-NA	● schwarz	512,00	477,00	448,00	421,00	
		ADIN-50-0301-NA	● rot	539,00	503,00	472,00	444,00	
		ADIN-50-0302-NA	● grün	566,00	528,00	495,00	466,00	
	750x300x65	ADIN-65-0300-NA	● schwarz	654,00	610,00	572,00	538,00	
		ADIN-65-0301-NA	● rot	689,00	643,00	603,00	568,00	
		ADIN-65-0302-NA	● grün	723,00	675,00	633,00	595,00	

Gummiplatten – Regranulat					Preis			
nr.	Produkt	Maß	code ADITEG	farbe	0 - 9 m <sup>2</sup>	10 - 49 m <sup>2</sup>	50 - 99 m <sup>2</sup>	od 100 m <sup>2</sup>
19	Links-Eck-Rampe zur Fallschutzmatte für Spielplätze	750x300x20	ADIN-20-0300-RL	● schwarz	190,00	177,00	166,00	156,00
			ADIN-20-0301-RL	● rot	199,00	186,00	174,00	164,00
			ADIN-20-0302-RL	● grün	208,00	194,00	182,00	171,00
		750x300x25	ADIN-25-0300-RL	● schwarz	225,00	210,00	197,00	185,00
			ADIN-25-0301-RL	● rot	236,00	220,00	206,00	194,00
			ADIN-25-0302-RL	● grün	247,00	230,00	216,00	203,00
		750x300x30	ADIN-30-0300-RL	● schwarz	280,00	261,00	245,00	230,00
			ADIN-30-0301-RL	● rot	293,00	274,00	257,00	241,00
			ADIN-30-0302-RL	● grün	307,00	286,00	268,00	253,00
		750x300x35	ADIN-35-0300-RL	● schwarz	300,00	280,00	262,00	247,00
			ADIN-35-0301-RL	● rot	314,00	293,00	275,00	259,00
			ADIN-35-0302-RL	● grün	329,00	307,00	288,00	271,00
		750x300x40	ADIN-40-0300-RL	● schwarz	330,00	308,00	288,00	271,00
			ADIN-40-0301-RL	● rot	346,00	323,00	303,00	285,00
			ADIN-40-0302-RL	● grün	362,00	338,00	316,00	298,00
		750x300x45	ADIN-45-0300-RL	● schwarz	369,00	345,00	323,00	304,00
			ADIN-45-0301-RL	● rot	388,00	362,00	339,00	319,00
			ADIN-45-0302-RL	● grün	406,00	379,00	355,00	334,00
		750x300x50	ADIN-50-0300-RL	● schwarz	379,00	354,00	332,00	312,00
			ADIN-50-0301-RL	● rot	400,00	373,00	350,00	329,00
			ADIN-50-0302-RL	● grün	419,00	391,00	367,00	345,00
750x300x65	ADIN-65-0300-RL	● schwarz	483,00	451,00	423,00	398,00		
	ADIN-65-0301-RL	● rot	510,00	476,00	446,00	420,00		
	ADIN-65-0302-RL	● grün	534,00	499,00	467,00	440,00		
20	Rechts-Eck-Rampe zur Fallschutzmatte für Spielplätze	750x300x20	ADIN-20-0300-RP	● schwarz	190,00	177,00	166,00	156,00
			ADIN-20-0301-RP	● rot	199,00	186,00	174,00	164,00
			ADIN-20-0302-RP	● grün	208,00	194,00	182,00	171,00
		750x300x25	ADIN-25-0300-RP	● schwarz	225,00	210,00	197,00	185,00
			ADIN-25-0301-RP	● rot	236,00	220,00	206,00	194,00
			ADIN-25-0302-RP	● grün	247,00	230,00	216,00	203,00
		750x300x30	ADIN-30-0300-RP	● schwarz	280,00	261,00	245,00	230,00
			ADIN-30-0301-RP	● rot	293,00	274,00	257,00	241,00
			ADIN-30-0302-RP	● grün	307,00	286,00	268,00	253,00
		750x300x35	ADIN-35-0300-RP	● schwarz	300,00	280,00	262,00	247,00
			ADIN-35-0301-RP	● rot	314,00	293,00	275,00	259,00
			ADIN-35-0302-RP	● grün	329,00	307,00	288,00	271,00
		750x300x40	ADIN-40-0300-RP	● schwarz	330,00	308,00	288,00	271,00
			ADIN-40-0301-RP	● rot	346,00	323,00	303,00	285,00
			ADIN-40-0302-RP	● grün	362,00	338,00	316,00	298,00
		750x300x45	ADIN-45-0300-RP	● schwarz	369,00	345,00	323,00	304,00
			ADIN-45-0301-RP	● rot	388,00	362,00	339,00	319,00
			ADIN-45-0302-RP	● grün	406,00	379,00	355,00	334,00
		750x300x50	ADIN-50-0300-RP	● schwarz	379,00	354,00	332,00	312,00
			ADIN-50-0301-RP	● rot	400,00	373,00	350,00	329,00
			ADIN-50-0302-RP	● grün	419,00	391,00	367,00	345,00
750x300x65	ADIN-65-0300-RP	● schwarz	483,00	451,00	423,00	398,00		
	ADIN-65-0301-RP	● rot	510,00	476,00	446,00	420,00		
	ADIN-65-0302-RP	● grün	534,00	499,00	467,00	440,00		

# GUMMIPLATTEN

REGRANULAT



GUMMIPLATTEN

Gummiplatten - Regranulat					Preis					
nr.	Produkt	Maß	code ADITEG	farbe	0 - 9 m <sup>2</sup>	10 - 49 m <sup>2</sup>	50 - 99 m <sup>2</sup>	od 100 m <sup>2</sup>		
21	Elastische glatte Gummiplatte 500x500mm	500x500x20	ADI-E1-20-0300-00	● schwarz	589,00	550,00	515,00	485,00		
			ADI-E1-20-0301-00	● rot	647,00	604,00	567,00	533,00		
			ADI-E1-20-0302-00	● grün	706,00	659,00	618,00	581,00		
		500x500x30	ADI-E1-30-0300-00	● schwarz	948,00	885,00	830,00	781,00		
			ADI-E1-30-0301-00	● rot	1.031,00	963,00	903,00	849,00		
			ADI-E1-30-0302-00	● grün	1.065,00	994,00	932,00	877,00		
		500x500x40	ADI-E1-40-0300-00	● schwarz	1.182,00	1.103,00	1.034,00	973,00		
			ADI-E1-40-0301-00	● rot	1.270,00	1.186,00	1.111,00	1.046,00		
			ADI-E1-40-0302-00	● grün	1.329,00	1.240,00	1.163,00	1.094,00		
		500x500x50	ADI-E1-50-0300-00	● schwarz	1.482,00	1.383,00	1.297,00	1.220,00		
			ADI-E1-50-0301-00	● rot	1.548,00	1.445,00	1.354,00	1.275,00		
			ADI-E1-50-0302-00	● grün	1.611,00	1.504,00	1.410,00	1.327,00		
22	Elastische glatte Gummiplatte 1000x1000mm	1000x1000x15	ADI-E3-15-0300-00	● schwarz	496,00	463,00	434,00	408,00		
			ADI-E3-15-0301-00	● rot	546,00	510,00	478,00	450,00		
			ADI-E3-15-0302-00	● grün	595,00	555,00	520,00	490,00		
		1000x1000x20	ADI-E3-20-0300-00	● schwarz	589,00	550,00	515,00	485,00		
			ADI-E3-20-0301-00	● rot	647,00	604,00	567,00	533,00		
			ADI-E3-20-0302-00	● grün	706,00	659,00	618,00	581,00		
		1000x1000x30	ADI-E3-30-0300-00	● schwarz	948,00	885,00	830,00	781,00		
			ADI-E3-30-0301-00	● rot	1.032,00	963,00	903,00	849,00		
			ADI-E3-30-0302-00	● grün	1.065,00	994,00	932,00	877,00		
		1000x1000x40	ADI-E3-40-0300-00	● schwarz	1.182,00	1.103,00	1.034,00	973,00		
			ADI-E3-40-0301-00	● rot	1.270,00	1.186,00	1.111,00	1.046,00		
			ADI-E3-40-0302-00	● grün	1.329,00	1.240,00	1.163,00	1.094,00		
		1000x1000x50	ADI-E3-50-0300-00	● schwarz	1.482,00	1.383,00	1.297,00	1.220,00		
			ADI-E3-50-0301-00	● rot	1.548,00	1.445,00	1.354,00	1.275,00		
			ADI-E3-50-0302-00	● grün	1.611,00	1.504,00	1.410,00	1.327,00		
		23	Elastische Gummiplatte mit dem Raster 500x500mm	500x500x30	ADI-E1-30-0300-15	● schwarz	900,00	840,00	788,00	742,00
					ADI-E1-30-0301-15	● rot	993,00	926,00	869,00	817,00
					ADI-E1-30-0302-15	● grün	1.022,00	954,00	895,00	842,00
500x500x40	ADI-E1-40-0300-15			● schwarz	1.177,00	1.098,00	1.030,00	969,00		
	ADI-E1-40-0301-15			● rot	1.235,00	1.153,00	1.081,00	1.017,00		
	ADI-E1-40-0302-15			● grün	1.300,00	1.213,00	1.138,00	1.071,00		
500x500x50	ADI-E1-50-0300-15			● schwarz	1.527,00	1.425,00	1.336,00	1.258,00		
	ADI-E1-50-0301-15			● rot	1.139,00	1.063,00	997,00	938,00		
	ADI-E1-50-0302-15			● grün	1.687,00	1.574,00	1.476,00	1.389,00		
24	Elastische Gummiplatte mit dem Raster 1000x1000mm	1000x1000x30	ADI-E3-30-0300-15	● schwarz	900,00	840,00	788,00	742,00		
			ADI-E3-30-0301-15	● rot	993,00	926,00	869,00	817,00		
			ADI-E3-30-0302-15	● grün	1.022,00	954,00	895,00	842,00		
		1000x1000x40	ADI-E3-40-0300-15	● schwarz	1.177,00	1.098,00	1.030,00	969,00		
			ADI-E3-40-0301-15	● rot	1.235,00	1.153,00	1.081,00	1.017,00		
			ADI-E3-40-0302-15	● grün	1.300,00	1.213,00	1.138,00	1.071,00		
		1000x1000x50	ADI-E3-50-0300-15	● schwarz	1.527,00	1.425,00	1.336,00	1.258,00		
			ADI-E3-50-0301-15	● rot	1.602,00	1.496,00	1.402,00	1.320,00		
			ADI-E3-50-0302-15	● grün	1.687,00	1.574,00	1.476,00	1.389,00		



Gummiplatten – Regranulat					Preise						
nr.	Produkt	Maß	code ADITEG	farbe	0 - 9 m <sup>2</sup>	10 - 49 m <sup>2</sup>	50 - 99 m <sup>2</sup>	od 100 m <sup>2</sup>			
25	Verbundpflaster	200x165x43	ADI-K1-43-9900-00	● schwarz	1.329,00	1.241,00	1.163,00	1.095,00			
			ADI-K1-43-9901-00	● rot	1.416,00	1.322,00	1.239,00	1.166,00			
			ADI-K1-43-9902-00	● grün	1.504,00	1.403,00	1.316,00	1.238,00			
26	Verbundplatte	1120x1000x15	ADI-Z1-15-0300-00	● schwarz	651,00	608,00	570,00	536,00			
			ADI-Z1-15-0301-00	● rot	704,00	657,00	616,00	580,00			
			ADI-Z1-15-0302-00	● grün	781,00	729,00	684,00	643,00			
		1120x1000x30	DI-Z1-30-0300-ADI-R	● černá	1.094,00	1.021,00	957,00	901,00			
			DI-Z1-30-0301-ADI-R	● schwarz	1.147,00	1.071,00	1.004,00	945,00			
			DI-Z1-30-0302-ADI-R	● rot	1.199,00	1.119,00	1.049,00	987,00			
		1120x1000x43	DI-Z1-43-0300-ADI-R	● schwarz	1.356,00	1.266,00	1.187,00	1.117,00			
			DI-Z1-43-0301-ADI-R	● rot	1.408,00	1.314,00	1.232,00	1.160,00			
			DI-Z1-43-0302-ADI-R	● grün	1.460,00	1.363,00	1.278,00	1.203,00			
27	Glatte Gummiplatte	1000x1000x7	ADI-H3-07-0300-00	● schwarz	309,00	288,00	270,00	254,00			
			ADI-H3-07-0301-00	● rot	395,00	369,00	346,00	326,00			
			ADI-H3-07-0302-00	● grün	457,00	427,00	400,00	377,00			
		1000x1000x11	ADI-H3-11-0300-00	● schwarz	457,00	427,00	400,00	377,00			
			ADI-H3-11-0301-00	● rot	556,00	519,00	487,00	458,00			
			ADI-H3-11-0302-00	● grün	637,00	594,00	557,00	524,00			
		1000x1000x15	ADI-H3-15-0300-00	● schwarz	556,00	519,00	487,00	458,00			
			ADI-H3-15-0301-00	● rot	686,00	640,00	600,00	565,00			
			ADI-H3-15-0302-00	● grün	804,00	750,00	703,00	662,00			
		1000x1000x23	ADI-H3-23-0300-00	● schwarz	847,00	791,00	741,00	698,00			
			ADI-H3-23-0301-00	● rot	1.044,00	975,00	914,00	860,00			
			ADI-H3-23-0302-00	● grün	1.200,00	1.120,00	1.050,00	988,00			
		2000x1000x7	ADI-H4-07-0300-00	● schwarz	309,00	288,00	270,00	254,00			
			2000x1000x11	ADI-H4-11-0300-00	● schwarz	457,00	427,00	400,00	377,00		
			2000x1000x15	ADI-H4-15-0300-00	● schwarz	556,00	519,00	487,00	458,00		
			2000x1000x23	ADI-H4-23-0300-00	● schwarz	847,00	791,00	741,00	698,00		
			28	Antivibrations-Gummimatte	2000x1000x23	ADI4-23-9700-00	● schwarz	751,00	701,00	657,00	619,00
					2000x1000x11	ADI4-11-9700-00	● schwarz	344,00	321,00	301,00	283,00
Glatte Gummiplatte Spezial	1200x1000x16	ADI-16-0100-00	● schwarz	1.032,00	963,00	903,00	849,00				
	1200x1000x20	ADI-20-0100-00	● schwarz	1.294,00	1.208,00	1.132,00	1.066,00				
Glatte Gummiplatte Spezial - formatiert	1980x890x16	H4-16-9700-00-1100	● schwarz	1.791,00	1.671,00	1.567,00	1.475,00				
Vulkanisierte Stallmatte mit Hammermuster	1800x1200x17	ADI7-17-3300-HT	● schwarz	1.805,00	1.685,00	1.579,00	1.487,00				
Stallmatte	1000x500x55	ADI2-55-0400-VA	● schwarz	1.377,00	1.285,00	1.205,00	1.134,00				
	1000x500x55	ADI2-55-0401-VA	● rot	1.435,00	1.339,00	1.256,00	1.182,00				
	1000x1000x40	ADI3-40-0400-15	● schwarz	1.208,00	1.127,00	1.057,00	995,00				
29	Sandkasten-Gummi-Bordstein	1000x300x150	ADI1-00-0300-00	● schwarz	1.413,00	1.319,00	1.236,00	1.164,00			
			ADI1-00-0301-00	● rot	1.473,00	1.375,00	1.289,00	1.213,00			
			ADI1-00-0302-00	● grün	1.556,00	1.452,00	1.361,00	1.281,00			
Sandkasten-Gummi-Bordstein	1500x300x150	ADI5-00-0300-00	● schwarz	2.313,00	2.159,00	2.024,00	1.905,00				
		ADI5-00-0301-00	● rot	2.428,00	2.267,00	2.125,00	2.000,00				
		ADI5-00-0302-00	● grün	2.555,00	2.384,00	2.235,00	2.104,00				
Gehweg-Gummi-Bordstein	1000x250x50	ADI2-00-0300-00	● schwarz	552,00	515,00	483,00	455,00				
		ADI2-00-0301-00	● rot	592,00	553,00	518,00	488,00				
		ADI2-00-0302-00	● grün	652,00	609,00	570,00	537,00				
30	Sandkasten-Gummi-Bordstein	1150x300x150	ADI4-00-0300-00	● schwarz	1.413,00	1.319,00	1.236,00	1.164,00			
			ADI4-00-0301-00	● rot	1.473,00	1.375,00	1.289,00	1.213,00			
			ADI4-00-0302-00	● grün	1.556,00	1.452,00	1.361,00	1.281,00			

# GUMMIPATTEN

REGRANULAT



GUMMIPATTEN

Gummiplatten – Regranulat					Preis			
nr.	Produkt	Maß	code ADITEG	farbe	0 - 9 m <sup>2</sup>	10 - 49 m <sup>2</sup>	50 - 99 m <sup>2</sup>	od 100 m <sup>2</sup>
31	Bordsteinabdeckung	1000x1000x100	ADI7-00-0300-00	● schwarz	328,00	306,00	287,00	270,00
			ADI7-00-0301-00	● rot	360,00	336,00	315,00	296,00
			ADI7-00-0302-00	● grün	388,00	362,00	339,00	319,00
32	Palisade	H=400, Ø=250	ADI1-40-9900-00	● schwarz	642,00	599,00	562,00	529,00
			ADI1-40-9901-00	● rot	691,00	645,00	605,00	569,00
			ADI1-40-9902-00	● grün	728,00	680,00	637,00	600,00
		H=600, Ø=250	ADI2-60-9900-00	● schwarz	920,00	858,00	805,00	757,00
			ADI2-60-9901-00	● rot	967,00	902,00	846,00	796,00
			ADI2-60-9902-00	● grün	1.019,00	951,00	891,00	839,00
		H=800, Ø=250	ADI3-80-9900-00	● schwarz	1.231,00	1.149,00	1.077,00	1.014,00
			ADI3-80-9901-00	● rot	1.297,00	1.211,00	1.135,00	1.069,00
			ADI3-80-9902-00	● grün	1.366,00	1.275,00	1.195,00	1.125,00
	H=1000, Ø=250	ADI4-00-9900-00	● schwarz	1.541,00	1.438,00	1.348,00	1.269,00	
		ADI4-00-9901-00	● rot	1.622,00	1.514,00	1.419,00	1.336,00	
		ADI4-00-9902-00	● grün	1.706,00	1.592,00	1.493,00	1.405,00	
Würfel	300x300x300	ADI1-30-9901-00	● rot	1.513,00	1.412,00	1.324,00	1.246,00	
Bordsteinabdeckung	1000x400x150	ADI3-00-0301-00	● rot	1.185,00	1.106,00	1.037,00	976,00	
33	EPDM-Zuschlag für alle Gummiplatten für Spielplätze und elastische Gummiplatten	alle Stärken	schwartz 4021		983,00	918,00	860,00	810,00
			rot 4062 - RAL 3016		1.035,00	966,00	906,00	853,00
			grün 4067 - RAL 6021		1.081,00	1.009,00	946,00	890,00
			RAL 5015, RAL 1014, RAL 1002, RAL 7038, RAL 7037, RAL 7011, RAL 8025, RAL 5012, RAL 1015		1.127,00	1.052,00	986,00	928,00
			RAL 1012, RAL 6017		1.264,00	1.180,00	1.106,00	1.041,00
			RAL 6005, RAL 5010, RAL 4003, RAL 4005, RAL 2008, RAL 3017		1.403,00	1.309,00	1.227,00	1.155,00
			mix		1.196,00	1.116,00	1.046,00	985,00
			mix S		688,00	642,00	602,00	567,00
34	Gras-Gummiplatte	500x500x25	ADI1-25-5610-15		1.247,00	1.164,00	1.091,00	1.027,00
		500x500x30	ADI1-30-5610-15		1.406,00	1.312,00	1.230,00	1.158,00
35	Gummiplatte mit dem Parkettmuster	500x500x25	ADI1-25-0300-15	● schwarz	642,00	599,00	561,00	528,00
			ADI1-25-0301-15	● rot	694,00	648,00	607,00	572,00
			ADI-25-0302-15	● grün	743,00	693,00	650,00	612,00

Positionen, die sich nicht auf Kundenpreise beziehen.					Preis			
nr.	Bohren und Stifte	Bezeichnung	Menge	code ADITEG	0 - 9 ks	10 - 49 ks	50 - 99 ks	od 100 ks
36	Das Bohren ist ab einer Plattenstärke von mindestens 25mm möglich	<b>Das Bohren von zwei Seiten</b>	gültig für 1 Stk. Gummiplatte	ADI9990	<b>gratis</b>	<b>gratis</b>	<b>gratis</b>	<b>gratis</b>
		<b>Das Bohren von vier Seiten</b>	gültig für 1 Stk. Gummiplatte	ADI9991	<b>gratis</b>	<b>gratis</b>	<b>gratis</b>	<b>gratis</b>
		<b>Verbindungsstift</b>	1 Stk. Gummiplatte sind 4 Stifte nötig	ADI8888	<b>2,80</b>	<b>2,60</b>	<b>2,40</b>	<b>2,30</b>
		<b>Verbindungsstift</b>	pro 1 Stk. Gummiplatte sind 4 Stifte nötig	ADI9999	<b>2,80</b>	<b>2,60</b>	<b>2,40</b>	<b>2,30</b>
37	Verbindungselemente für Bordsteinabdeckungen und Sandkasten-Gummi-Bordsteine	<b>Verbindungsstift für Bordsteinabdeckung</b>	pro Stück werden 3 Stifte benötigt	ADI3-SPOJ-0080	<b>4,10</b>	<b>3,80</b>	<b>3,60</b>	<b>3,30</b>
		<b>Verbindungsrohr für Sandkasten-Gummi-Bordstein Ob4</b>	Länge 280mm	ADI4-SPOJ-0280	<b>108,00</b>	<b>101,00</b>	<b>95,00</b>	<b>89,00</b>
		<b>Verbindungsrohr für Sandkasten-Gummi-Bordstein Ob4</b>	Länge 600mm	ADI4-SPOJ-0600	<b>112,00</b>	<b>105,00</b>	<b>98,00</b>	<b>93,00</b>
		<b>Verbindungsrohr für Sandkasten-Gummi-Bordstein Ob4</b>	Länge 750mm	ADI4-SPOJ-0750	<b>118,00</b>	<b>110,00</b>	<b>104,00</b>	<b>97,00</b>

Mehrwegverpackungen				Preis
Paletten	Maß	code ADITEG	1 stk.	
Holzpalette	1200x800	ADI0301	<b>265,00</b>	
Holzpalette	1000x1000	ADI0308	<b>265,00</b>	
Holzpalette	1200x1100	ADI0311	<b>298,00</b>	
Holzpalette	2000x1000	ADI0305	<b>415,00</b>	

1/ Glatte Gummiplatte für Spielplätze 20mm mit eingepressten Löchern 25mm a 30mm



2/ Gummiplatte für Spielplätze 40mm mit eingepressten Löchern

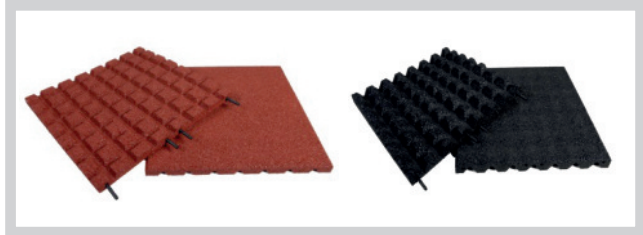

3/ Gummiplatte für Spielplätze 45mm mit eingepressten Löchern



4/ Gummiplatte für Spielplätze 50mm mit eingepressten Löchern

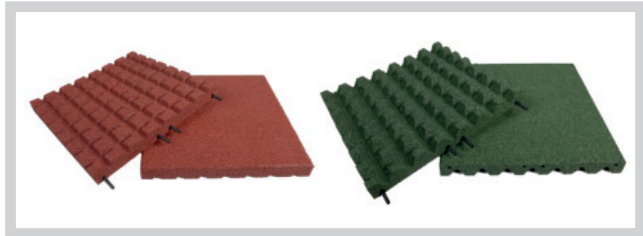

# GUMMIPLATTEN

REGRANULAT



5/ Gummiplatte für Spielplätze 55mm, 65mm a 75mm mit eingepressten Löchern 6/ Gummiplatte für Spielplätze 80mm

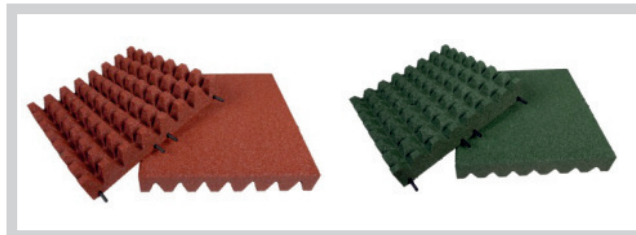
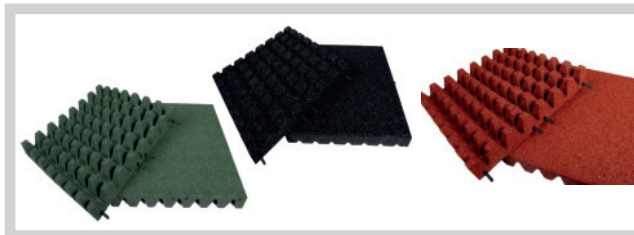

7/ Gummiplatte für Spielplätze 90mm



8/ Gummiplatte für Spielplätze 100mm

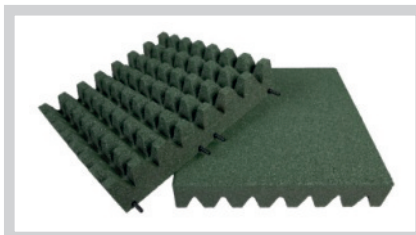

9/ Randplatte, Eckplatte und Halbplatte 30mm



10/ Randplatte, Eckplatte und Halbplatte 40mm



11/ Randplatte, Eckplatte und Halbplatte 45mm

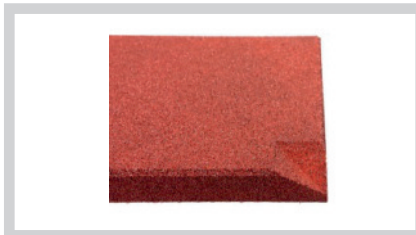

12/ Randplatte, Eckplatte und Halbplatte 50mm



13/ Randplatte, Eckplatte und Halbplatte 55mm



14/ KRandplatte, Eckplatte und Halbplatte 65mm



15/ Randplatte, Eckplatte und Halbplatte 80mm



16/ Randplatte, Eckplatte und Halbplatte 90mm



17/ Randplatte, Eckplatte und Halbplatte 100mm

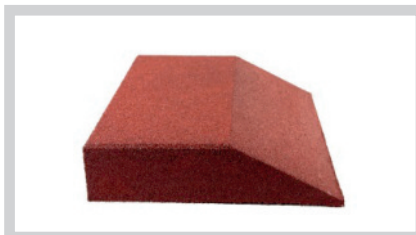

18/ Rampe zur Fallschutzmatte für Spielplätze



19/ Links-Eck-Rampe zur Fallschutzmatte für Spielplätze



20/ Rechts-Eck-Rampe zur Fallschutzmatte für Spielplätze



21/ Elastische glatte Gummiplatte 500x500mm



22/ Elastische glatte Gummiplatte 1000x1000mm



23/ Elastische Gummiplatte mit dem Raster 500x500mm



24/ Elastische Gummiplatte mit dem Raster 1000x1000mm



25/ Verbundpflaster



26/ Verbundplatte



27/ Glatte Gummiplatte

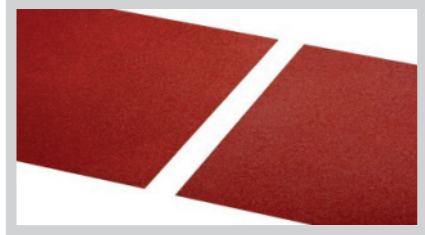

28/ Antivibrations-Gummimatte, Gummiplatte Spezial, Stallmatten



29/ Sandkasten-, Gehweg-Gummi-Bordstein



30/ Sandkasten-Gummi-Bordstein



31/ Gehweg-Bordsteinabdeckung



32/ Palisade



33/ EPDM-Zuschlag für alle Gummiplatten

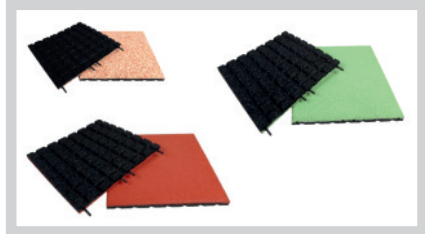

34/ Gras-Gummiplatte



35/ Gummiplatte mit Parkettmuster



36 a 37/ Bohren und Stifte und Verbindungselemente



# BODENPLATTEN



Bodenplatten dienen als Isolier-, Sicherheits- und Schutzbelag.





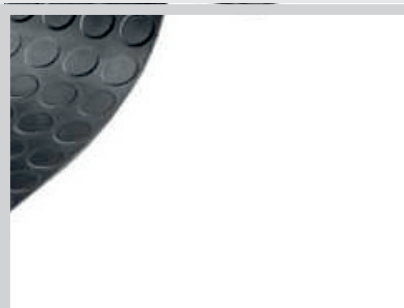
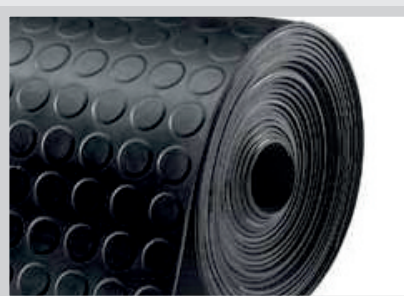
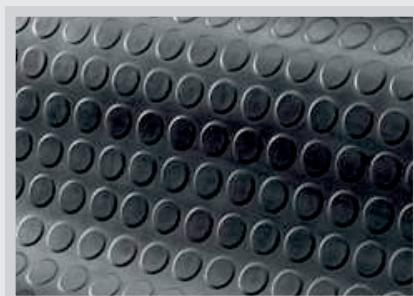
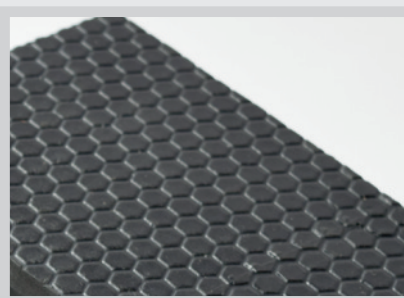







Die Art des verwendeten Materials kann je nach der Nutzung im Außen- oder Innenbereich sowie nach dem Entflammbarkeitsgrad, nach der Beständigkeit gegen Chemikalien, Öle, Benzin und weiteren Stoffen ausgewählt werden

*...dichtet sofort*



# GUMMI-BODENPLATTEN

Standardmaße von 1200x10000mm ist auf Lager, sowie Breite von 1400/1500/1800/2000mm, Preise und Verfügbarkeit auf Anfrage.

Gummi-Bodenplatten			Preis		
nr.	Bezeichnung		Stärke	1 - 11,99m <sup>2</sup>	12 - 119,99m <sup>2</sup>
1	Riefen-Gummimatte – klein		3mm	<b>288,70</b>	<b>165,00</b>
			4mm	<b>385,30</b>	<b>220,20</b>
			5mm	<b>593,40</b>	<b>339,10</b>
2	Riefen-Gummimatte – groß		3mm	<b>340,10</b>	<b>222,20</b>
			4mm	<b>455,10</b>	<b>297,20</b>
3	Riefen-Gummimatte – Spezial		3mm	<b>352,00</b>	<b>201,10</b>
			4mm	<b>474,40</b>	<b>271,10</b>
4	Riefen-Gummimatte – gemischt		3mm	<b>352,20</b>	<b>228,10</b>
			4mm	<b>477,90</b>	<b>309,40</b>
			5mm	<b>603,60</b>	<b>390,90</b>
			6mm	<b>729,20</b>	<b>472,30</b>
5	Münzen-Gummimatte		3mm	<b>352,00</b>	<b>201,10</b>
			4mm	<b>474,60</b>	<b>271,20</b>
			5mm	<b>784,20</b>	<b>448,10</b>
			6mm	<b>945,10</b>	<b>541,80</b>
			7mm	<b>1.274,80</b>	<b>728,50</b>
6	Checker Gummimatte		3mm	<b>352,00</b>	<b>201,10</b>
			4mm	<b>474,40</b>	<b>271,10</b>
			5mm	<b>593,00</b>	<b>338,90</b>
7	Hammer Gummimatte		3mm	<b>352,20</b>	<b>228,10</b>
			4mm	<b>477,90</b>	<b>309,40</b>
			5mm	<b>603,60</b>	<b>390,90</b>
			6mm	<b>729,20</b>	<b>472,30</b>
8	Hammer Gummimatte – Spezial		8mm	<b>1023,80</b>	<b>663,00</b>
			10mm	<b>1279,00</b>	<b>828,40</b>
			12mm	<b>1535,30</b>	<b>994,20</b>
			15mm	<b>1919,20</b>	<b>1.242,90</b>
9	Steinchen Gummimatte		3mm	<b>363,60</b>	<b>235,50</b>
			4mm	<b>484,60</b>	<b>313,80</b>
			6mm	<b>727,40</b>	<b>471,10</b>
			8mm	<b>969,20</b>	<b>627,70</b>
10	Steinchen Gummimatte – Spezial		12mm	<b>2.101,50</b>	<b>1.360,90</b>
			17mm	<b>2.573,50</b>	<b>1.666,70</b>
11	Gummimatte kariert		8mm	<b>1.049,80</b>	<b>599,80</b>
12			12mm	<b>2.248,20</b>	<b>1.352,30</b>

nr.	Bezeichnung		Stärke	0,01 - 11,99m <sup>2</sup>	od 12m <sup>2</sup>
13	Münzen-Gummimatte – PVC bunt		3mm	<b>389,70</b>	<b>231,30</b>

1/ Riefen-Gummimatte – klein

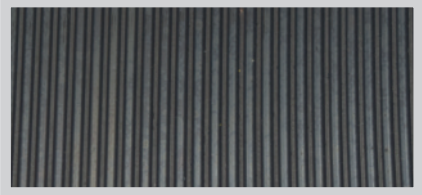

2/ Riefen-Gummimatte – groß



3/ Riefen-Gummimatte – Spezial

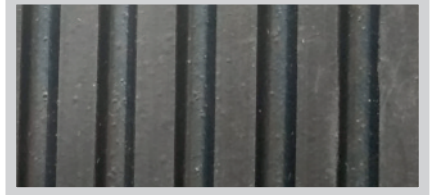

4/ Riefen-Gummimatte – gemischt

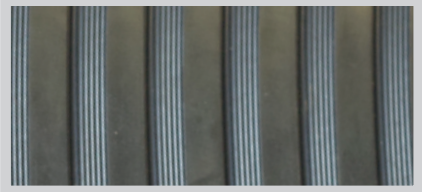

5/ Münzen-Gummimatte



6/ Checker Gummimatte

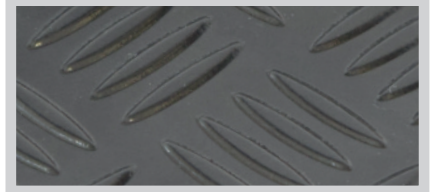

7/ Hammer Gummimatte



8/ Hammer Gummimatte – Spezial

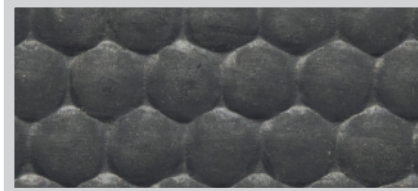

9/Steinchen Gummimatte

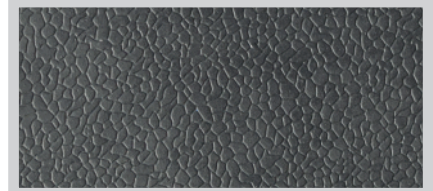

10/Steinchen Gummimatte – Spezial

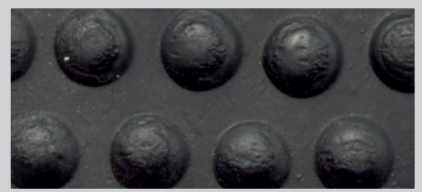

11/ Gummimatte kariert



12/ Caro Gummimatte (erste Seite)



12/ Caro Gummimatte – Spezial (zweite Seite)

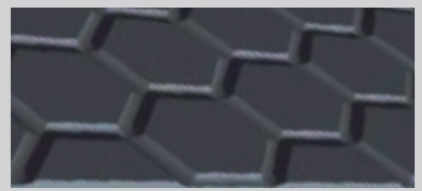

13/ Münze Gummimatte – bunt

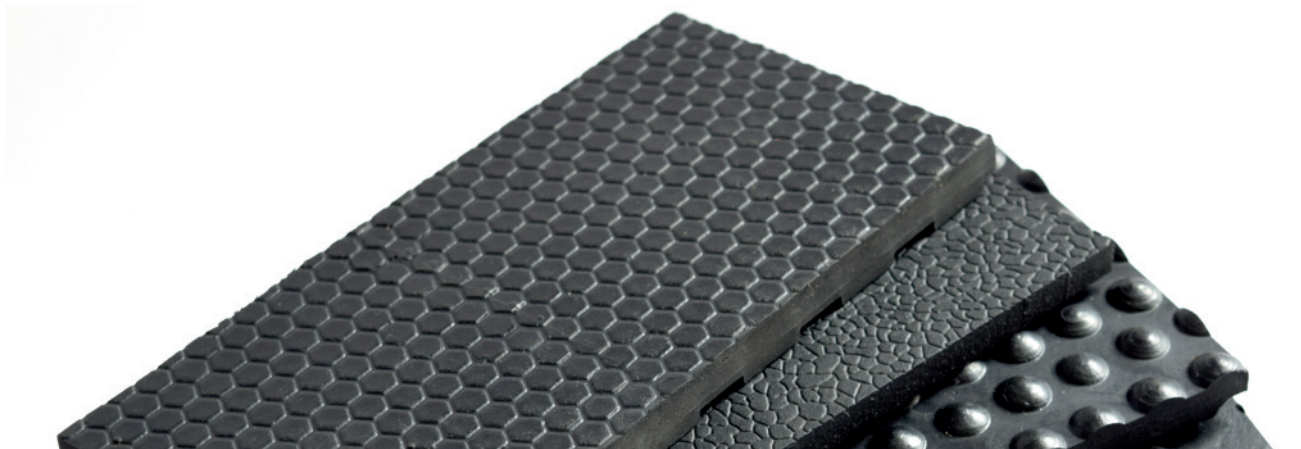
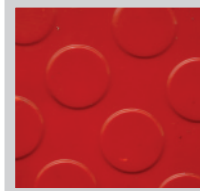



# PVC-BODENPLATTEN

PVC-Bodenplatten			Preis		
nr.	Bezeichnung		Stärke	0,01 - 11,99m <sup>2</sup>	od 12m <sup>2</sup>
1	Riefen-Gummimatte – klein		2,2mm	261,00	169,00
2	Münzen-Gummimatte		2,2mm	261,00	169,00
3	Hammer Gummimatte Gitter-Gummimatte		2,2mm	261,00	169,00
4	Gummimatte gekästelt/Gitter-Gummiplatte		2,2mm	261,00	169,00
5	Pyramiden-Gummimatte		2,2mm	261,00	169,00
6	Pyramiden-Gummimatte – Spezial		3,6mm	270,60	175,30
			4mm	333,90	216,20
7	Linsen-Gummimatte		2,2mm	261,00	169,00
8	Münzen-Gummimatte – bunt		2,2mm	261,00	169,00

1/ Riefen-Gummimatte – klein



2/ Münzen-Gummimatte



3/ Hammer Gummimatte

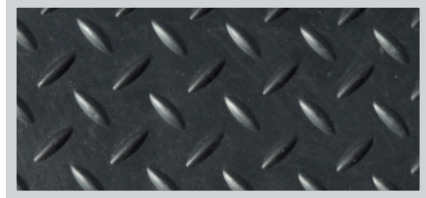

4/ Gitter-Gummimatte

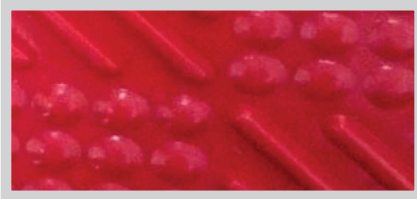

5/ Pyramiden-Gummimatte

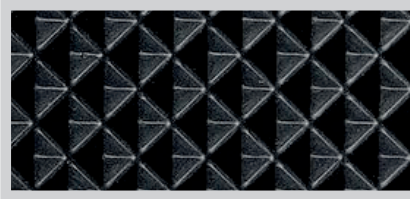

6/ Pyramiden-Gummimatte – Spezial

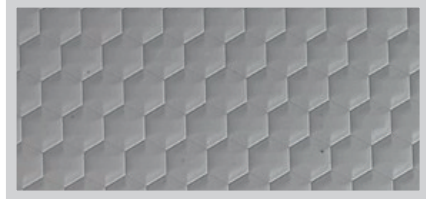

7/ Linsen-Gummimatte



8/ Münzen-Gummimatte – bunt

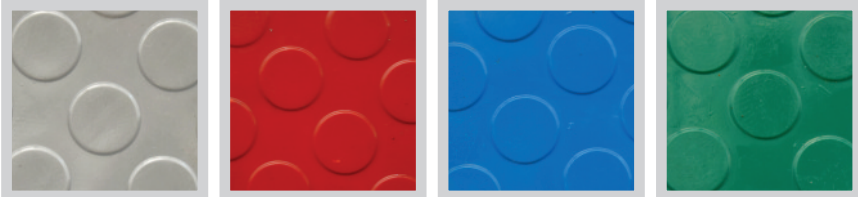

# KUNSTSTOFF-BODENPLATTEN

Kunststoff-Bodenplatten						Preis			
nr.	code ADITEG	Bezeichnung	Maß 	kg/stk	stk/pal	1 - 9 stk	10 - 24 stk	25 - 49 stk	od 50 stk
1	ADI-1019-32	Pontongeländeplatte + Verbindungsschlösser	4000x2000x32	330	5	38.021,40	35.486,70	33.268,80	31.311,80
2	ADI-1019A-32	Pontongeländeplatte + Verbindungsschlösser	3000x2000x32	264	5	31.220,00	29.138,70	27.317,50	25.710,60
3	ADI-1019-32	Pontongeländeplatte + Verbindungsschlösser	4000x1000x32	165	10	21.532,90	20.097,30	18.841,30	17.732,90
4	ADI-1019A-33	Pontongeländeplatte + Verbindungsschlösser	3000x1000x32	120	10	18.475,70	17.244,00	16.166,30	15.215,30
5	ADI-1019-43	Belastungsmatte	1200x800x43	32	30	719,10	671,20	629,20	592,20
6	ADI-1029A-43	Tröpfchen-Belastungs-Matte	1200x800x43	34	30	761,60	710,80	666,40	627,20
7	ADI-1039-43	Belastungsmatte-klein	800x600x43	18	60	361,40	337,30	316,20	297,60
8	ADI-1039R-43	Belastungs-Rost	800x600x43	11	60	284,90	265,90	249,30	234,60
9	ADI-1069-43	Universalplatte für Interieur	1200x800x43	28,5	30	670,50	625,80	586,70	552,20
10	ADI-1079-22	Steinchenplatte - klein	800x600x22	11,5	100	275,40	257,00	240,90	226,80
11	ADI-1099Z-22	Bodenplatte für Interieur – voll verstärkt klein	80x600x22	12,5	100	275,40	257,00	240,90	226,80
12	ADI-1119-22	Stallmatte klein	800x600x22	10,2	100	255,90	238,90	223,90	210,80
13	ADI-1139-43	Paddockplatte	1200x800x43	28	30	719,10	671,20	629,20	592,20
14	ADI-1139A-43	Paddockplatte gelocht (O25mm, 6x20mm)	1200x800x43	27	30	767,70	716,50	671,70	632,20
15	ADI-1159-22	Bodenplatte für Interieur	1200x800x22	2020	50	508,20	474,30	444,70	418,50
16	ADI-1159S-22	Tröpfchen-Bodenplatte für Interieur	1200x800x22	19	50	508,20	474,30	444,70	418,50
17	ADI-1159A-22	Bodenplatte für Interieur gelocht (O25mm, 6x20mm)	1200x800x22	16,5	50	556,80	519,70	487,20	458,50
18	ADI-1179-12	Glatte Bodenplatte für Interieur	1200x800x22	13,5	60	424,50	396,20	371,50	349,60
19	ADI-1179A-12	Glatte Bodenplatte für Interieur gelocht (O25mm,6x20mm)	1200x800x22	16,5	60	470,70	439,30	411,80	387,60
20	ADI-1189-12	Stallmatte glatt	1200x800x22	24	60	424,50	396,20	371,50	349,60
21	ADI-1209-22	Beidseitige Bodenplatte für Interieur	1200x800x22	16,5	50	573,80	439,30	502,10	472,50
22	ADI-1219-12	Glatte Kugelplatte	1200x800x22	13,5	60	424,50	396,20	371,50	349,60
23	ADI-1219A-12	Glatte Kugelplatte gelocht (O25mm, 6x20mm)	1200x800x22	13,5	60	470,70	57,00	411,50	387,60
24	ADI-1219P-12	Glatte Kugelplatte gelocht – Puzzle	1158x780x12	11,5	60	561,70	524,30	491,50	462,60
25	ADI-1239-22	Kugelplatte für Interieur - klein – eingespritzt	800x600x22	20	100	275,40	257,00	240,90	226,80
26	ADI-1249-22	Kugelplatte für Interieur	1200x800x22	124	50	508,20	474,30	444,70	418,50
27	ADI-2505-43	Hochrampe „unter“	400x100x43	1,2		76,40	71,30	66,90	62,90
28	ADI-2515-22	Niederrampe „unter“	400x100x22	0,6		60,60	56,60	53,10	49,90
29	ADI-2615-22	Niederrampe „über“	400x100x22	0,6		60,60	56,60	53,10	49,90
30	ADI-2625-43	Hochrampe „über“ nur für 102	400x100x43	1,2		76,40	71,30	66,90	62,90
31	ADI-2635-43	Hochrampe „über“ 104, 105, 106, 113	400x100x43	1,2		76,40	71,30	66,90	62,90
32	ADI-2745-43	Verbindungstück - hoch	400x100x43	2		140,80	131,40	123,20	115,90
33	ADI-2795-22	Verbindungstück - niedrig	400x100x22	1,2		114,10	106,50	99,80	93,90



1-4/ Pontongeländeplatte + Verbindungsschlösser

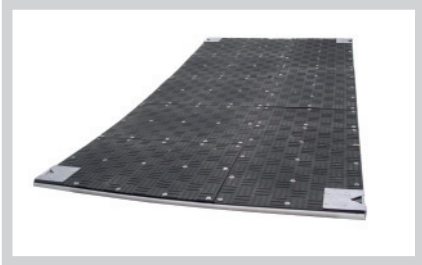

5/ Belastungsmatte

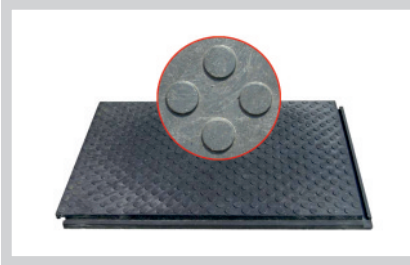

6/ ZTröpfchen-Belastungs-Matte

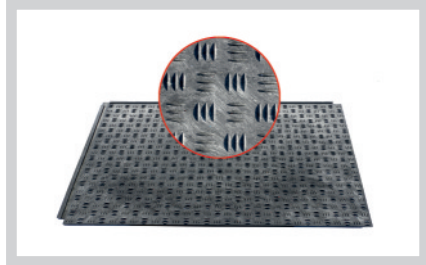

7/ Belastungsmatte-klein

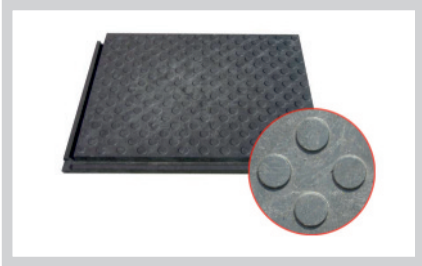

8/ Belastungs-Rost

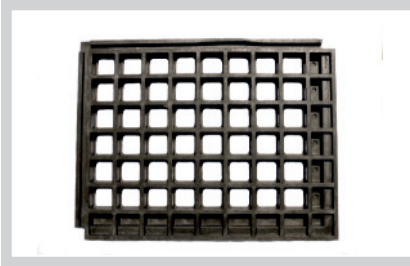

9/ Universalplatte für Interieur

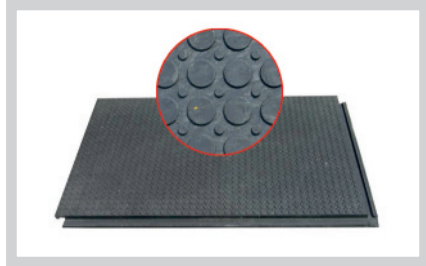

10/ Steinchenplatte - klein

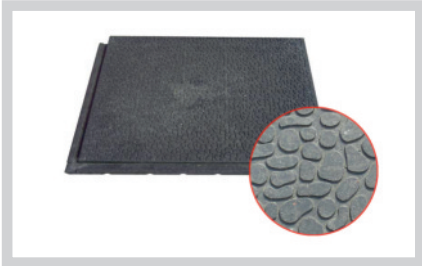

11/Bodenplatte für Interieur –verstärkt klein

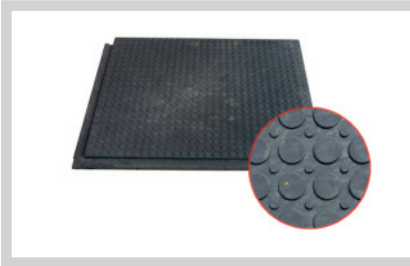

12/ Stallmatte klein

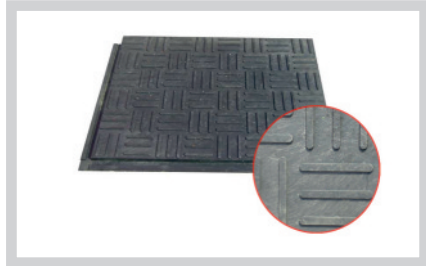

13/ Paddockplatte

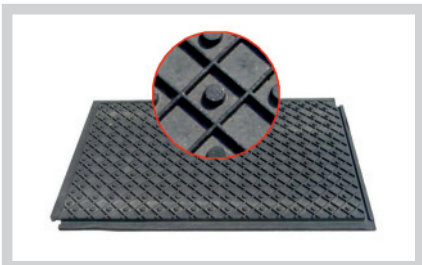

14/ Paddockplatte gelocht

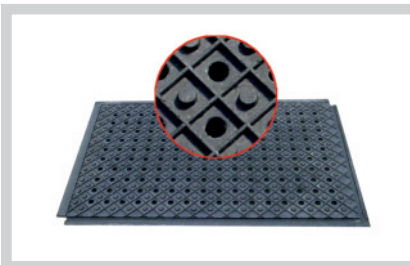

15/ Bodenplatte für Interieur

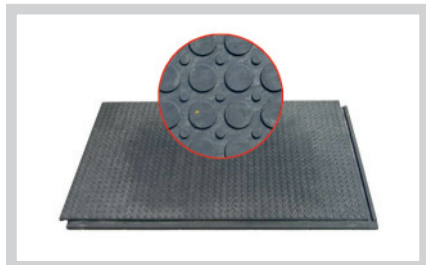

16/ Tröpfchen-Bodenplatte für Interieur

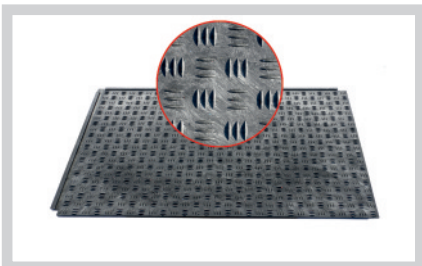

17/ Bodenplatte für Interieur gelocht

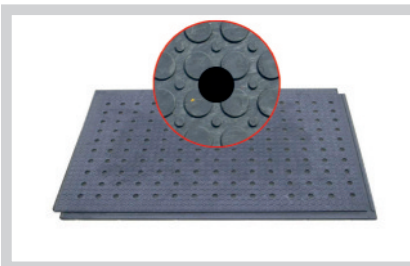

118/ Glatte Bodenplatte für Interieur

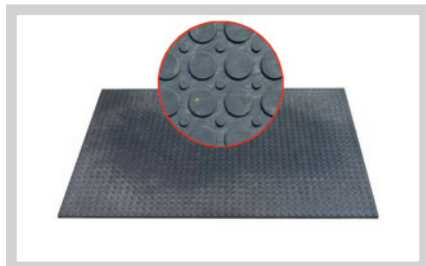

19/ Glatte Bodenplatte für Interieur gelocht

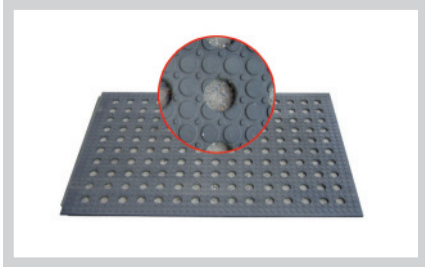

20/ Stallmatte glatt



21/ Beidseitige Bodenplatte für Interieur

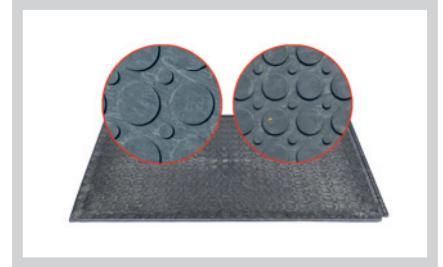

22/ Glatte Kugelplatte

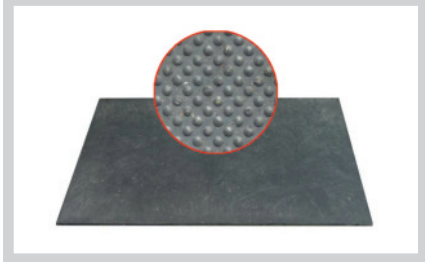

23/ Glatte Kugelplatte gelocht

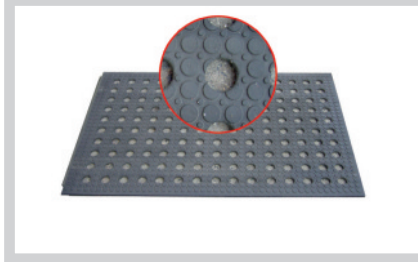

24/ Glatte Kugelplatte gelocht – Puzzle

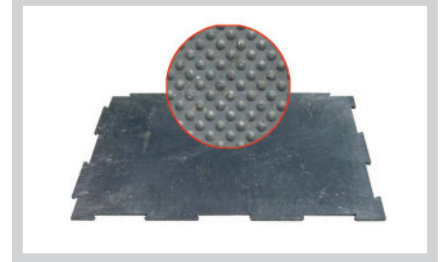

25/ Kugelplatte für Interieur - klein

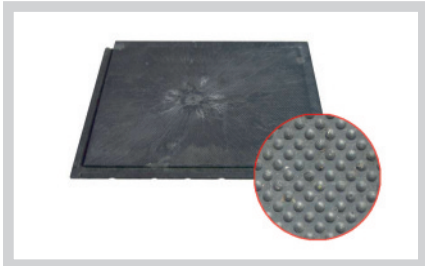

26/ Kugelplatte für Interieur

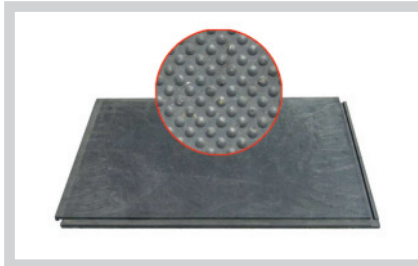

27/ Hochrampe „unter“



28/ Niederrampe „unter“

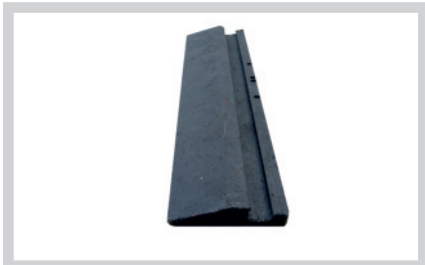

29/ Niederrampe „über“



30/ Hochrampe „über“ nur für 102



31/ Hochrampe „über“ 104, 105, 106, 113

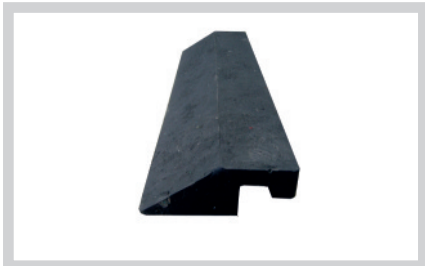

32/ Verbindungstück - hoch

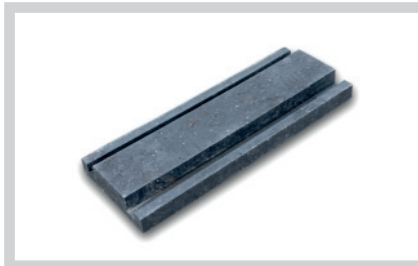

33/ Verbindungstück - niedrig



# GUMMIMATTEN

Neu im Sortiment der Firma ADITEG s.r.o. befinden sich hochwertige Gummimatten, die in den unten angegebenen Maßen lieferbar sind. Gummimatten eignen sich sowohl für den Innenraum, als auch den Außenraum. Ihr Eingang wird nicht nur repräsentativ aussehen, sondern bleibt zudem sauber, was für den ersten Eindruck eines Besuchers wichtig ist. Tür-Gummimatten sind nicht nur für Eingangsräume ideal, sondern auch vor Treppen, für Werkstätten, Arbeitsstellen mit durchfließendem Wasser. Sie sind ebenso für die Beförderung von Niederhubwägen mit geringer Ladung oder für PKW-Parkplätze geeignet. Die Nutzung dieser Gummimatten dient zur Erhöhung der Produktivität, Entfernung von grobem Schmutz, bzw. Schnee, Lärmdämmung und Isolierung. Die Gummimatten stellen ein komplexes Programm für Sicherheit, Sauberkeit und Komfort dar. Sie sind ideal für nasse, schlammige und beschneite Plätze. Wir bieten Gummimatten in verschiedenen Größen und Farben zu günstigen Preisen an.

Vorteile und Interessantes: Die Gummimatten können allgemein gut geputzt werden. Sie sind gut geformt, sodass Sie nicht darüber stolpern. Am Rand der Gummikante befindet sich eine Anlaufkante, die das Stolpern oder Fallen verhindert und Autos das Überfahren ermöglicht.

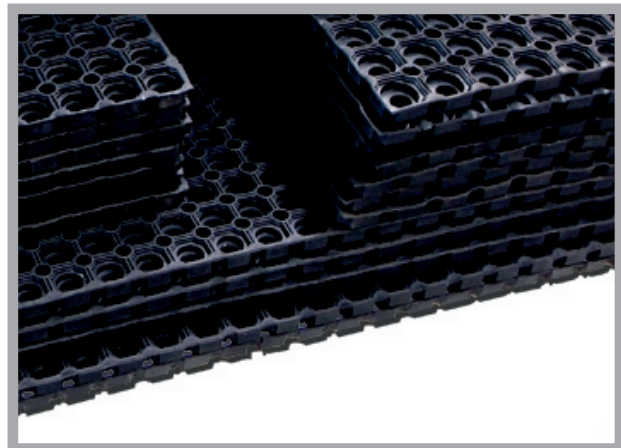
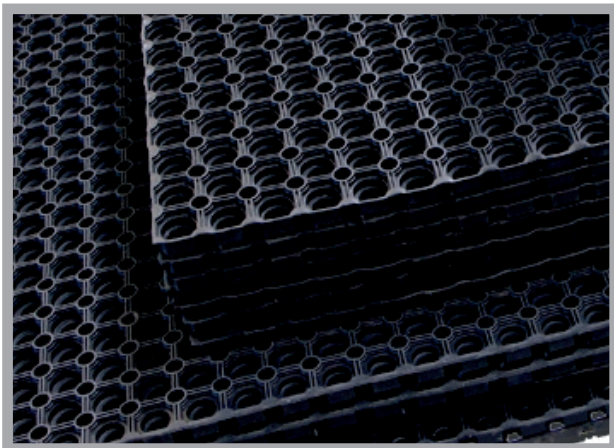
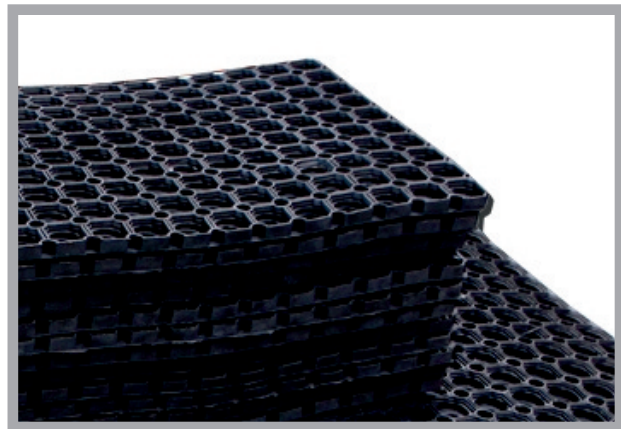
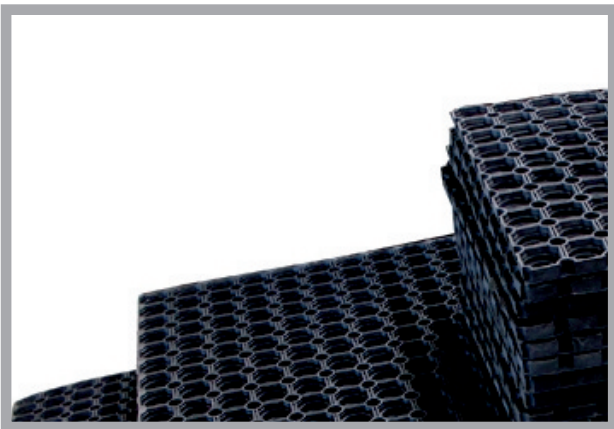

# GUMMIMATTEN

## TÜR-GUMMIMATTEN



GUMMIMATTEN

Gummimatten – Tür-Gummimatten					Preis		
nr.	code ADITEG	Maß 	1 - 4 stk	5 - 9 stk	10 - 49 stk	50 - 99 stk	od 100 stk
1	101-ADI-welcome	450x750mm	94,80	75,90	63,20	54,20	50,60
2	102-ADI-Löcher	400x600mm	67,30	53,80	44,90	38,50	35,90
		400x700mm	72,60	58,10	48,40	41,50	38,70
		450x750mm	127,70	102,20	85,10	73,00	68,10
3	103-ADI-Spur	400x600mm	56,60	45,30	37,70	32,30	30,20
		450x750mm	94,80	75,90	63,20	54,20	50,60
4	104-ADI-Blatt	400x600mm	56,60	45,30	37,70	32,30	30,20
		450x750mm	94,80	75,90	63,20	54,20	50,60
5	105-ADI-Würfel	400x600mm	56,60	45,30	37,70	32,30	30,20
		450x750mm	94,80	75,90	63,20	54,20	50,60
6	106-ADI-Katze	400x600mm	56,60	45,60	37,70	32,30	30,20
		450x750mm	94,80	75,90	63,20	54,20	50,60
7	107-ADI-Blätter	400x600mm	56,60	45,30	37,70	32,30	30,20
8	108-ADI-Blatt/welcome	400x600mm	56,60	45,30	37,70	32,30	30,20
		450x750mm	71,10	56,90	47,40	40,60	37,90
9	109-ADI-Löcher	400x600mm	87,20	49,70	58,10	49,80	46,50
		450x750mm	162,90	130,30	108,60	93,10	86,90
10	110-ADI-Hund	400x600mm	61,20	48,90	40,80	35,00	32,60
		450x750mm	99,40	79,50	66,30	56,80	53,00
11	111-ADI-Band	450x750mm	196,50	157,20	131,00	112,30	104,80
12	112-ADI-Spur/Lavor	400x800mm	129,20	103,40	86,20	73,80	68,90
13	113-ADI-Labyrinth	400x700mm	71,10	56,90	47,40	40,60	37,90
14	114-ADI-Band/Lavor	400x800mm	129,20	103,40	86,20	73,80	68,90
		400x900mm	147,60	118,10	98,40	84,30	78,70
15	115-ADI-Karo	400x600mm	87,20	69,70	58,10	49,80	46,50
16	116-ADI-Halbkreis	450x750x16mm	119,30	95,40	49,50	68,20	63,60
		450x750x22mm	168,20	134,60	112,20	96,10	89,70
17	117-ADI-welcome/Oval	400x700mm	71,10	56,90	47,40	40,60	37,90
18	118-ADI-Würfel	400x700mm	71,10	56,90	47,40	40,60	37,90
19	119-ADI-Rechteck	400x700mm	94,80	75,90	63,20	54,20	50,60
20	120-ADI-Labyrinth/welcome	400x700mm	71,10	56,90	47,40	40,60	37,90

1/ WELCOME



2/ LÖCHER

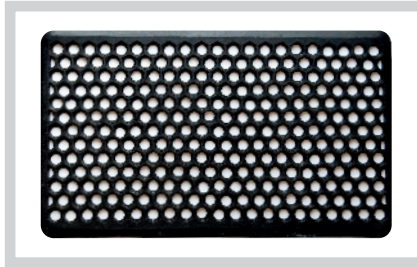

3/ SPUR



4/ BLATT

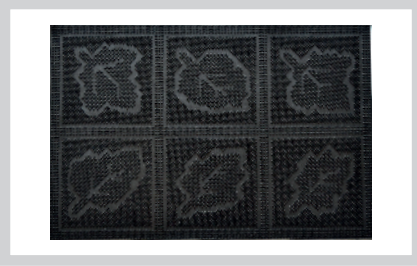

5/ WÜRFEL



6/ KATZE

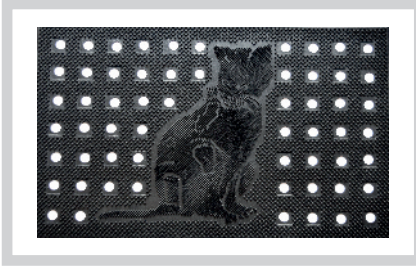

7/ BLÄTTER



8/ BLÄTTER - WELCOME



9/ LÖCHER

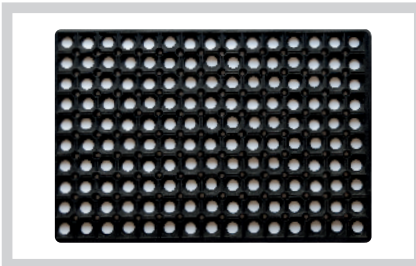

10/ HUND

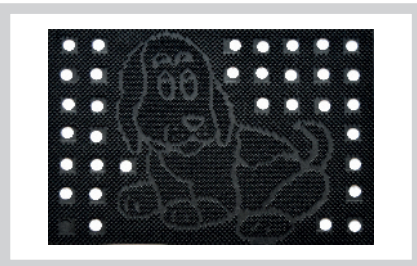

11/ BAND

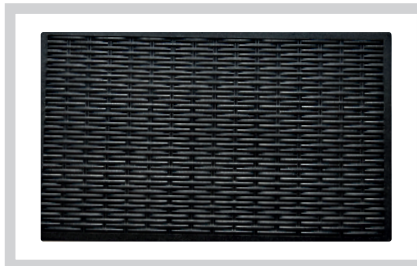

12/ SPUR - LAVOR



13/ LABYRINTH



14/ BAND - LAVOR



15/ KARO

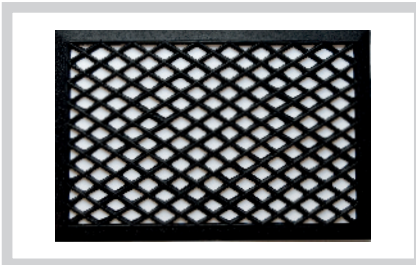

16/ HALBKREIS

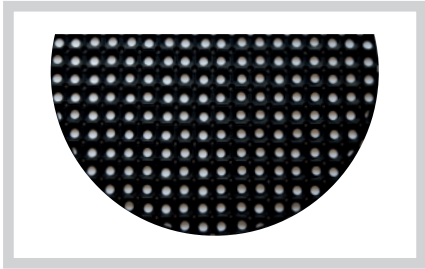

17/ WELCOME - OVAL



18/ WÜRFEL



19/ RECHTECK



20/ LABYRINTH - WELCOME





Gummimatten				Preis				
nr.	code ADITEG	Maß 	farbe	1 - 4 stk	5 - 9 stk	10 - 49 stk	50 - 99 stk	od 100 stk
1	ADITEG-402	1524x914x12mm	● schwarz	640,80	587,30	542,10	503,50	469,80
		1524x914x12mm	● rot	855,70	784,40	721,00	672,40	627,50
2	ADITEG-404	1000x1000x13mm	● schwarz	559,80	513,00	473,60	439,80	410,40
3	ADITEG-404-C	1800x1000x22mm	● schwarz	676,40	619,90	572,30	531,40	496,00
		1200x800x22mm	● schwarz	468,40	429,40	396,30	368,00	343,40
		1000x500x22mm	● schwarz	180,90	165,90	153,00	142,10	132,70
		800x500x22mm	● schwarz	158,00	144,70	133,60	124,10	115,90
		600x400x22mm	● schwarz	81,30	74,50	68,80	63,90	59,70
		1800x1000x16mm	● schwarz	595,60	546,00	504,00	468,10	436,90
		1200x800x16mm	● schwarz	368,20	337,60	311,60	289,30	270,0
		1000x500x16mm	● schwarz	157,40	144,30	133,20	123,70	115,30
4	ADITEG-406	800x500x16mm	● schwarz	155,50	142,60	131,70	122,30	114,00
		600x400x16mm	● schwarz	65,70	60,30	55,50	51,60	48,10
		1500x900x12mm	● schwarz	533,80	489,20	451,70	419,50	391,50
		1524x914x12mm	● rot	902,10	827,00	763,30	708,80	661,60
5	ADITEG-407	910x910x12mm	● schwarz	265,10	243,00	224,30	208,30	194,40
		910x910x14mm	● schwarz	330,50	303,00	279,60	259,70	242,50
		915x915x12mm	● rot	637,00	584,00	538,90	500,60	467,20
6	ADITEG-408	1500x900x22mm	● schwarz	915,40	845,00	784,60	732,20	686,60
		1500x900x22mm	● rot	1.252,20	1.155,90	1.073,30	1.001,80	939,20
7	ADITEG-409	1200x800x20mm	● schwarz	984,40	908,60	843,80	787,50	738,30
8	ADITEG-410	1200x800x20mm	● schwarz	984,40	908,60	843,80	787,50	738,30
9	ADITEG-411	500x500x8mm	● schwarz	180,00	166,10	154,30	144,00	135,00
10	ADITEG-412	390x390x25mm	● schwarz	253,20	230,40	217,00	205,00	189,90
11	ADITEG-413	1500x1000x23mm	● schwarz	830,50	808,90	787,30	746,60	699,80
12	ADITEG-414	1000x1000x17mm	● schwarz	949,50	876,50	815,90	759,60	712,10
13	ADITEG-415	910x910x14mm	● schwarz	379,70	350,50	325,40	303,80	284,80
14	ADITEG-416	1500x900x10,5mm	● schwarz	548,40	506,30	470,10	438,80	411,30
15	ADITEG-417	910x910x16mm	● schwarz	432,60	399,30	370,80	346,10	324,40
16	ADITEG-418	900x600x15mm	● schwarz	195,20	180,20	167,30	156,20	146,40
		1200x900x15mm	● schwarz	395,40	365,00	338,90	316,40	296,60
17	ADITEG-419	1800x900x8mm	● schwarz	738,60	681,80	633,10	590,90	553,90
		1500x900x8mm	● schwarz	685,70	632,90	587,70	548,60	514,30
		1000x600x8mm	● schwarz	200,30	184,80	171,60	160,20	150,20
		750x450x8mm	● schwarz	92,80	85,70	79,60	74,30	69,60
		600x400x8mm	● schwarz	48,40	44,70	41,50	38,70	36,30

1/ ADITEG-402

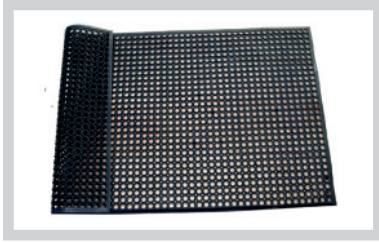

2/ ADITEG-404

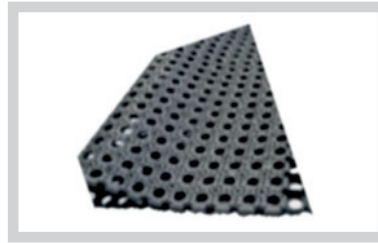

3/ ADITEG-404-C

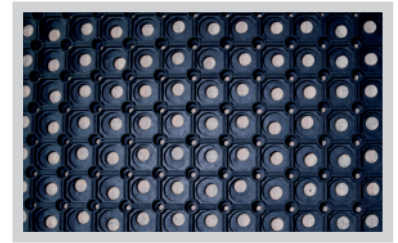

4/ ADITEG-406

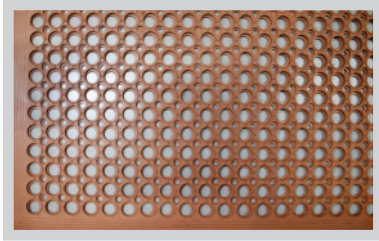

5/ ADITEG-407

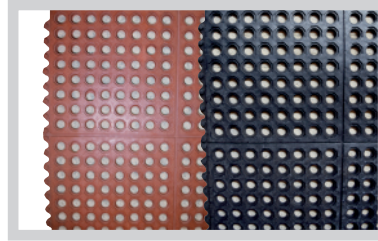

6/ ADITEG-408

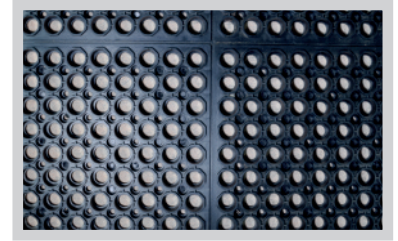

7/ ADITEG-409

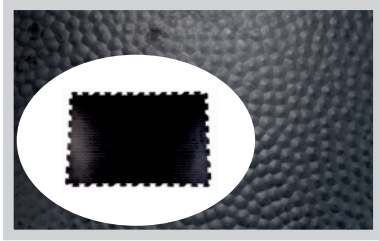

8/ ADITEG-410

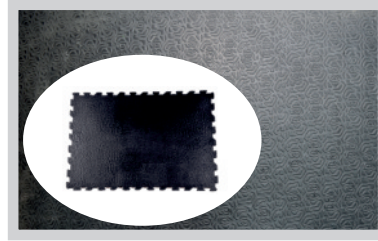

9/ ADITEG-411

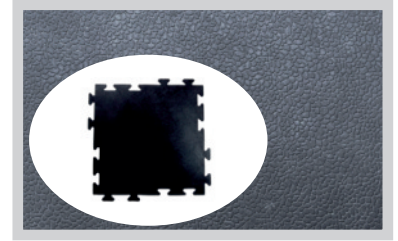

10/ ADITEG-412

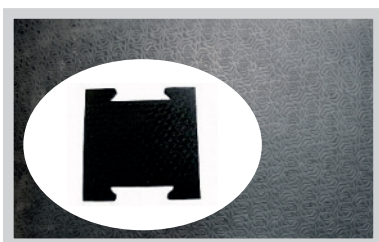

11/ ADITEG-413

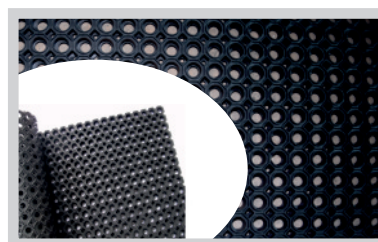

12/ ADITEG-114

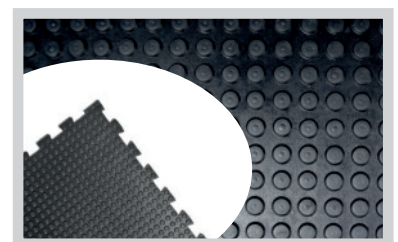

13/ ADITEG-415

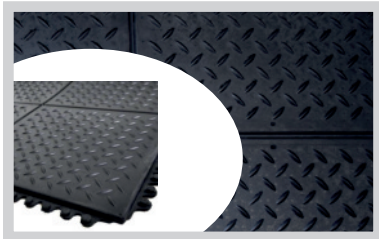

14/ ADITEG-416



15/ ADITEG-417

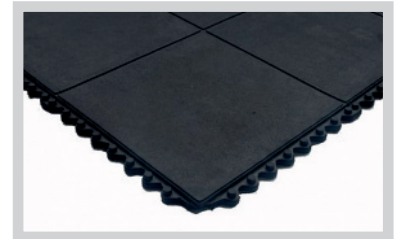

16/ ADITEG-418

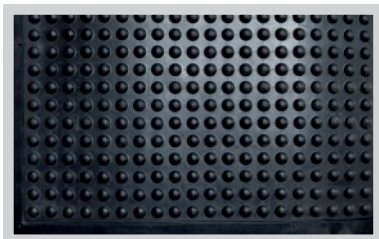

17/ ADITEG-419

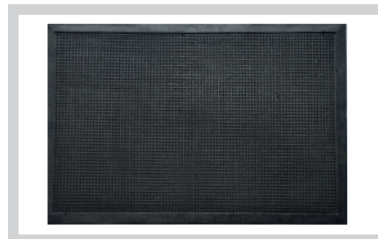

Die Gummimatte, auch Spaghettimatte genannt, besitzt aufgrund von eingeflochtenen Schnüren einen festen und beständigen Grund, der Unreinheiten, Schmutz und überschüssige Feuchtigkeit auffängt. Die Oberfläche der Gummimatte ist sehr weich und angenehm, deswegen bietet sich ihre Nutzung als Matte für Barfußbereiche wie Schwimmbecken oder Duschen an.

Der Boden der Gummimatte ist nicht geschlossen, deshalb kann angesammeltes Wasser unten herausfließen.

- Deutliche Anti-Rutsch-Wirkung
- Gummimatte als Dämpfer und Wirbelentlastung
- nicht brennbar und ölbeständig
- für Interieur und Exterieur
- einfache Pflege durch Ausklopfen, Absaugen, Auswaschen mit Wasser und üblichen Reinigungsmitteln

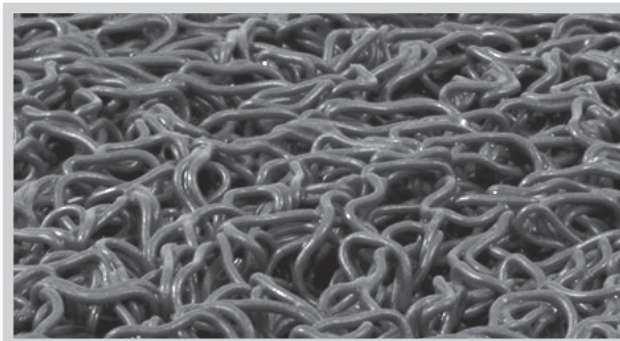
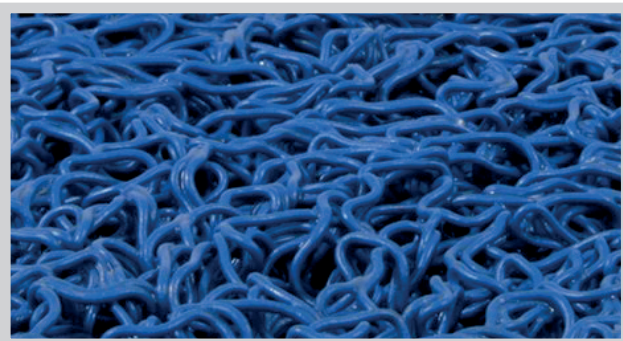

rutschfeste PVC-Matten		Preis	
	Stärke	0,01 - 17,99m <sup>2</sup>	18 - 179,99m <sup>2</sup>
	12mm	<b>754,20</b>	<b>488,50</b>
	15mm	<b>919,30</b>	<b>595,30</b>

# GUMMIMATTEN

## RUTSCHFESTE GUMMI-BADEMATTEN



Rutschfeste PVC-Gummi Badematten			Preis				
nr.	Bezeichnung	Maß 	1 - 5 stk	6 - 24 stk	25 - 99 stk	100 - 199 stk	od 200 stk
1	Blume	595x595mm	123,10	114,90	107,80	101,40	95,80
2	Oval	700x395mm	104,40	97,50	91,40	86,00	81,20
3	Rechteck	595x350mm	84,00	78,40	73,50	69,20	65,30
4	Kreis	Ø 540mm	123,00	114,80	107,70	101,30	95,70
5	Katze	565x500mm	96,90	90,40	84,80	79,80	75,30
6	Halbkreis	595x400mm	89,00	83,10	77,90	73,30	69,20
7	WC-Fußmatte	595x595mm	130,60	121,90	114,30	107,50	101,60
8	Delphin	595x200mm	117,70	109,80	103,00	96,90	91,50
9	Muschel	555x485mm	114,40	106,80	100,10	94,20	89,00

1/ BLUME

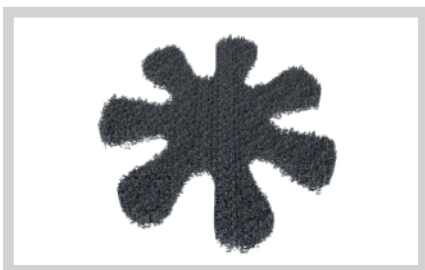

2/ OVAL

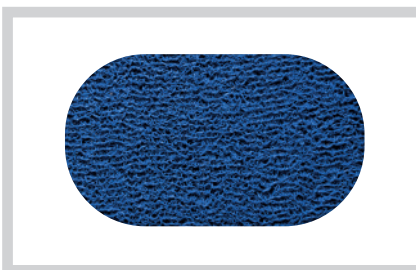

3/ RECHTECK

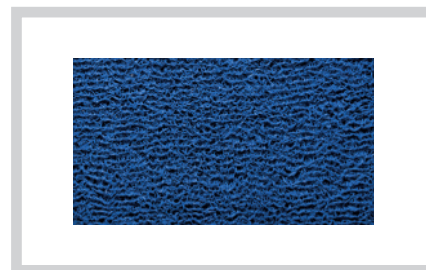

4/ KREIS

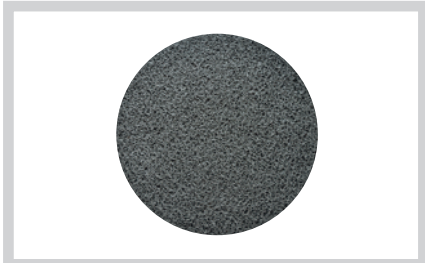

5/ KATZE



6/ HALBKREIS

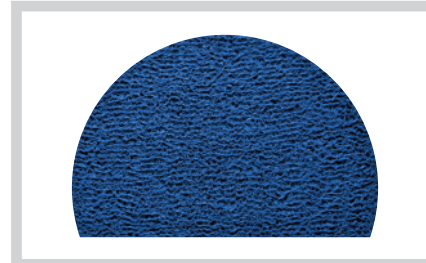

7/ WC-FUßMATTE



8/ DELPHIN

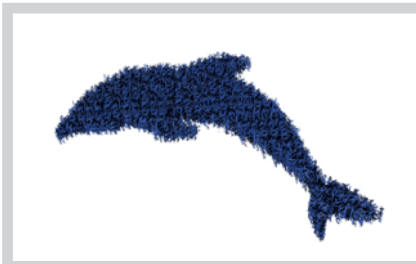

9/ MUSCHEL







# PFERDESTALLMATTEN

## ADITEG, G wie Gummi, der Komfort für Ihre Pferde....

Statten Sie Ihre Pferdeställe, Viehställe und Hundeställe mit hochwertigen Wärmeisolationsplatten (Stallmatten) aus. Unsere Stallmatten und Stallplatten für Tierställe werden aus SBR 65 +/- 5 Sha hergestellt.

- Erhöhung des Komforts für Pferde im Stall
- rutschfest, elastisch, weich
- warmhaltig
- Lärm- und Pralldämfer, verhindern Verletzungen bei Tieren
- geringer Verbrauch an Streu, geringe Kosten
- Pflege: mit Wasser abspülen

Pferdestallmatten				Preis				
nr.	ADITEG	Maß 	farbe	1 - 4 stk	5 - 9 stk	10 - 49 stk	50 - 99 stk	od 100 stk
1	ADITEG-411	500x500x8mm	● schwarz	180,00	166,10	154,30	144,00	135,00
2	ADITEG-412	390x390x25mm	● schwarz	253,20	230,40	217,00	205,00	189,90
3	ADITEG-415	910x910x14mm	● schwarz	379,70	350,50	325,40	303,80	284,80
4	ADITEG-417	910x910x16mm	● schwarz	432,60	399,30	370,80	346,10	324,40
5	ADITEG-414	1000x1000x17mm	● schwarz	949,50	876,50	815,90	759,60	712,10
6	ADITEG-423	1000x1000x18mm	● schwarz	1.149,30	1.021,60	919,40	835,80	766,20
7	ADITEG-410	1200x800x20mm	● schwarz	984,40	908,60	843,80	787,50	738,30
8	ADITEG-409	1200x800x20mm	● schwarz	984,40	908,60	843,80	787,50	738,30
nr.	ADITEG	Maß 	farbe	0,01 - 11,99 m <sup>2</sup>		12 - 99,99 m <sup>2</sup>		od 100 m <sup>2</sup>
9	Reggranulat	1250x10000x8mm	● schwarz	200,40		167,00		154,20
		1250x6000x10mm	● schwarz	240,80		200,70		185,30
		1250x6000x12mm	● schwarz	291,20		242,70		224,00
		1150x2300x15mm	● schwarz	342,30		285,20		263,50
		1150x2300x20mm	● schwarz	494,70		412,30		380,60
10	ADITEG-Platte - kariert	1250x10000x8mm	● schwarz	749,80		583,20		403,80
nr	ADITEG	Maß 	farbe	0,00 - 11,16 m <sup>2</sup>		11,17 - 111,62 m <sup>2</sup>		od 111,63 m <sup>2</sup>
11	ADITEG-Platte - Steinchen Spezial	1220x1830x12mm	● schwarz	693,90		449,40		390,77
		1220x1830x17mm	● schwarz	971,10		628,90		546,90
12	ADITEG-Platte - Karo / Karo Spezial	1220x1830x12mm	● schwarz	1.405,20		1.124,20		864,80
nr.	ADITEG	Maß 	farbe	0,01 - 9,99 m <sup>2</sup>	10 - 29,99 m <sup>2</sup>	30 - 49,99 m <sup>2</sup>	50 - 99,99 m <sup>2</sup>	od 100 m <sup>2</sup>
13	ADITEG-422	1000x2000x10mm	● schwarz	959,60	852,90	767,60	697,90	639,70
		1000x2000x15mm	● schwarz	1.404,40	1.248,40	1.123,50	1.021,40	936,30
		1000x2000x20mm	● schwarz	1.775,70	1.578,40	1.420,60	1.291,40	1.183,80

1/ ADITEG-411

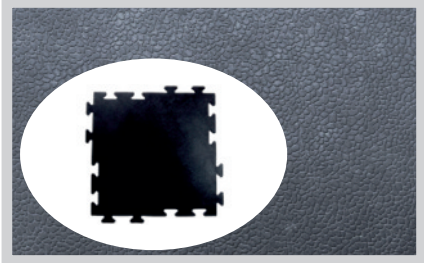

2/ ADITEG-412

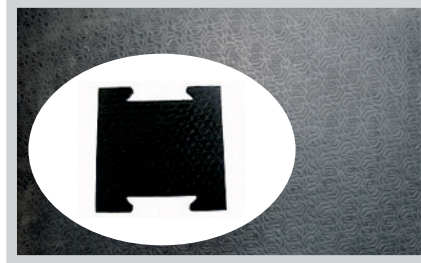

3/ ADITEG-415

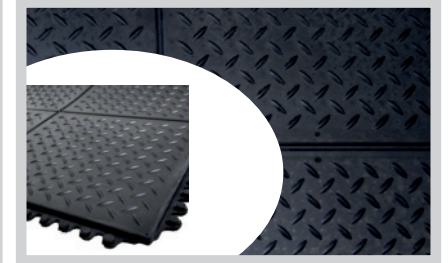

4/ ADITEG-417



5/ ADITEG-414

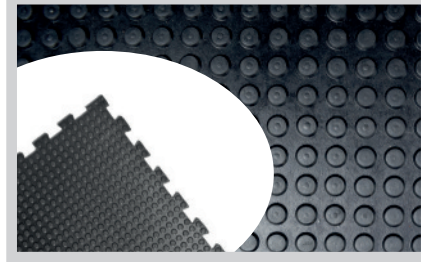

6/ ADITEG-423



7/ ADITEG-410

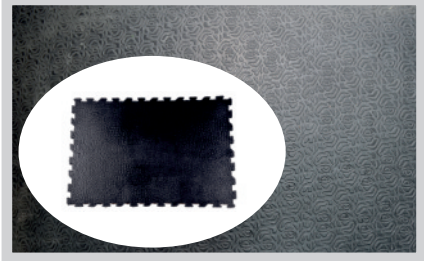

8/ ADITEG-409

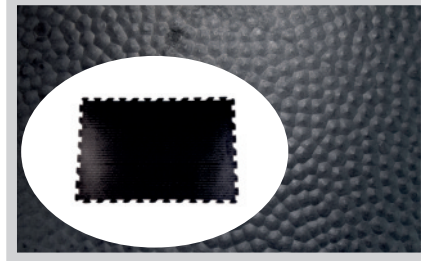

9/ REGRANULAT



10/ ADITEG - kariert



11/ ADITEG - Steinchen Spezial

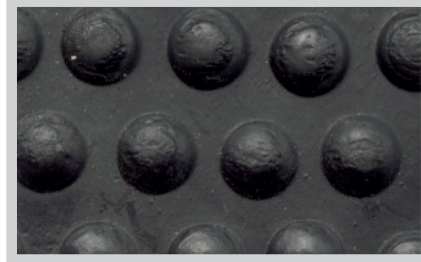

12/ ADITEG - Karo



12/ ADITEG - Karo spezial

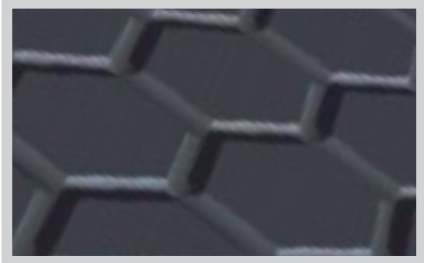

13/ ADITEG - 422

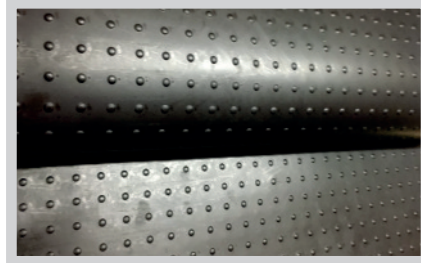

# ASBESTFREIE DICHTUNGSPLETTEN ADISEAL

**ADISEAL** - asbestfreie Dichtungsplatten, Polymer-Faser-Dichtungsplatten CSF

Asbestfreie Dichtungsplatten sind in vielen Industriebereichen, wie z.B. in der Automobilindustrie, im Maschinenbau usw., weit verbreitet.

Nutzung: Wasser, Gase, Öle, Alkohole, Hauptchemikalien

Zertifizierung: Germanischer Lloyd, KTW

- Rohgewicht DIN 28 090 - 2: 1,9 - 2,2g/cm<sup>2</sup>
- Farbe: rot, gelb, blau
- Temperaturbeständigkeit (dauernd): +140°C
- Temperaturbeständigkeit (kurzzeitig): +210°C
- Dampfbeständigkeit: +120°C Weitere Materialien auf Anfrage
- Zugfestigkeit DIN 52913: >22 Mpa
- Kompressibilität ASTM F 36 - J 5: -15%
- Wiederherstellung ASTM F 36 - J: min. 50%
- spez. Mengenundicht. DIN 3535 - 6: 0,15 mg/(s.m)
- Maß: 1500x1500mm

Andere Materialien nach spezifischer Nachfrage.

asbestfreie Dichtungsplatten		Preis		
	Stärke	0,01 - 2,24 m <sup>2</sup>	2,25 - 11,24 m <sup>2</sup>	OD 11,25 m <sup>2</sup>
	0,5 mm	<b>351,90</b>	<b>281,50</b>	<b>239,30</b>
	1,0 mm	<b>405,90</b>	<b>324,70</b>	<b>276,10</b>
	1,6 mm	<b>543,20</b>	<b>434,50</b>	<b>292,10</b>
	2,0 mm	<b>623,60</b>	<b>498,80</b>	<b>423,90</b>
	3,0 mm	<b>820,90</b>	<b>656,60</b>	<b>558,20</b>
	4,0 mm	<b>1.115,60</b>	<b>892,50</b>	<b>758,70</b>
	5,0 mm	<b>1.394,60</b>	<b>1.109,10</b>	<b>948,30</b>

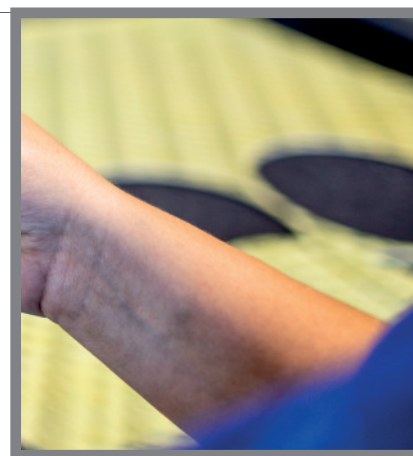

# FÖRDERBÄNDER

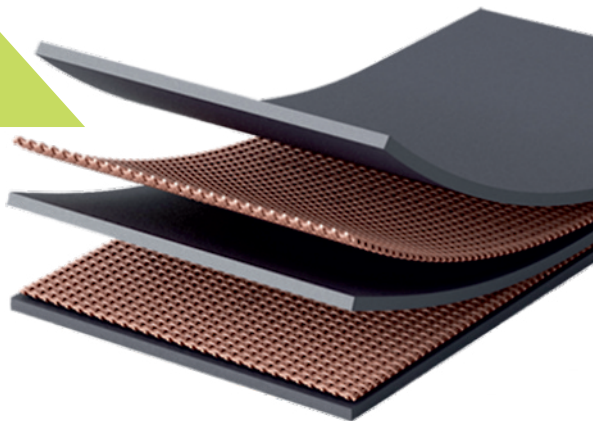

Förderbänder				Preis				
Typ	Einlagen	 Stärke	↔ Breite mm	0 - 9,99 bm	10 - 24,99 bm	25 - 49,99 bm	50 - 99,99 bm	od 100 bm
EP250/2Y	2	6,5 mm	400	277,30	256,00	237,70	211,80	208,00
			500	346,40	319,80	296,90	277,10	259,80
			650	450,40	415,70	386,00	360,30	337,80
			800	554,30	511,60	475,10	443,40	415,70
			1000	692,90	639,60	593,90	554,30	519,60
EP315/2AA	2	7 mm	400	307,90	284,20	263,90	246,30	230,90
			500	384,90	355,30	329,90	307,90	288,70
			650	500,30	461,90	428,90	400,30	375,30
			800	615,80	568,40	527,80	492,70	461,90
			1000	769,80	710,60	659,80	615,80	577,40
EP400/3Y	3	9 mm	400	388,00	358,10	332,60	310,40	291,00
			500	485,00	447,70	415,70	388,00	363,70
			650	630,40	581,90	540,40	504,40	472,80
			800	1.746,00	1.611,70	1.496,60	1.396,80	1.309,50
			1000	970,00	895,40	831,40	776,00	727,50
EP500/3AA	3	9 mm	400	404,90	313,70	347,00	323,90	303,60
			500	506,80	467,80	434,40	405,40	380,10
			650	657,90	607,30	563,90	526,30	493,40
			800	809,70	747,40	694,00	647,80	607,30
			1000	1.012,10	934,30	867,50	809,70	759,10
EP630/3AA	3	10 mm	400	486,20	448,80	416,80	389,00	364,70
			500	607,80	561,00	521,00	486,20	455,80
			650	790,10	729,30	677,20	632,10	592,60
			800	972,40	897,60	833,50	777,90	729,30
			1000	1.215,50	1.122,00	1.041,90	972,40	911,60
EP630/4A	4	12,2 mm	400	547,40	505,30	469,20	437,90	410,60
			500	684,30	631,70	586,50	547,40	513,20
			650	889,60	821,10	762,50	711,60	667,20
			800	1.094,80	1.010,60	938,40	875,80	821,10
			1000	1.368,50	1.263,30	1.173,00	1.094,80	1.026,40
			1200	1.642,20	1.515,90	1.407,60	1.313,80	1.231,70





## FÖRDERBÄNDER

# PTFE-PLATTEN / PTFE-STÄBE



...dichtet sofort

## PTFE-PLATTEN

PTFE -platte		Preis	
Stärke	Maß	0,01 - 7,19 m2	od 7,20 m2
0,3mm	1200x1200mm	<b>441,96</b>	<b>331,47</b>
0,5mm	1200x1200mm	<b>563,73</b>	<b>422,79</b>
0,7mm	1200x1200mm	<b>789,22</b>	<b>591,91</b>
1mm	1200x1200mm	<b>1.127,45</b>	<b>845,59</b>
1,5mm	1200x1200mm	<b>1.691,18</b>	<b>1.268,38</b>
2mm	1200x1200mm	<b>2.254,90</b>	<b>1.691,18</b>
2,5mm	1200x1200mm	<b>2.818,63</b>	<b>2.113,97</b>
3mm	1200x1200mm	<b>3.382,35</b>	<b>2.536,76</b>
4mm	1200x1200mm	<b>4.509,80</b>	<b>3.382,35</b>
5mm	1200x1200mm	<b>5.637,25</b>	<b>4.227,94</b>
6mm	1200x1200mm	<b>6.764,71</b>	<b>5.073,53</b>
8mm	1200x1200mm	<b>7.816,99</b>	<b>5.862,75</b>
9mm	1200x1200mm	<b>8.794,12</b>	<b>6.595,59</b>
10mm	1200x1200mm	<b>9.771,24</b>	<b>7.328,43</b>



## PTFE-Stäbe

PTFE -stab	Preis	
Durchmesser	0,01 - 9,99 m	od 10,00 m
10mm	<b>88,80</b>	<b>64,60</b>
20mm	<b>355,47</b>	<b>258,52</b>
30mm	<b>799,77</b>	<b>581,65</b>
40mm	<b>1.421,80</b>	<b>1.034,03</b>
50mm	<b>2.221,64</b>	<b>1.615,74</b>
60mm	<b>3.199,06</b>	<b>2.326,59</b>
70mm	<b>4.354,38</b>	<b>3.166,82</b>
80mm	<b>5.687,34</b>	<b>4.136,25</b>
90mm	<b>7.197,97</b>	<b>5.234,89</b>
100mm	<b>8.886,41</b>	<b>6.462,84</b>
110mm	<b>10.752,73</b>	<b>7.820,17</b>
120mm	<b>12.796,09</b>	<b>9.306,25</b>
130mm	<b>15.017,97</b>	<b>10.922,16</b>
140mm	<b>17.417,00</b>	<b>12.667,05</b>
150mm	<b>19.994,53</b>	<b>14.541,48</b>



## PTFE-BÄNDER

**Funktion:** Hergestellt aus 100%igen rein expandiertem PTFE, einseitig selbstklebendes Band für eine einfache Montage. Hohe Chemikalienbeständigkeit, ausgezeichnete Beständigkeit gegen Flüssigkeiten, Alterung, Witterung und UV. Effektive Abdichtung von unebenen Oberflächen. Diese Hochdruckdichtungen eignen sich bei der Montage, sind stabil und sehr anpassungsfähig.

### Schnelle und einfache Montage.

Universelle Anwendung als statische Abdichtung in fast allen Industriebereichen, vor allem aber als Dichtung für dauerhafte Flanschen in ähnlichen Anwendungsbereichen. Physiologisch unschädlich, geschmacksneutral, kann von Mikroorganismen weder angegriffen noch zersetzt werden. Die PTFE-Bänder erfüllen die Anforderungen der FDA 21CFR, der Regelung 177,1550 und der EU-Verordnung Nr. 1935/2004. Zertifizierung nach DVGW, BAM und FDA.

**Temperaturbeständigkeit:** -240 °C, +270 °C, +315 °C kurzzeitig

Maß	PTFE-Bänder		Preis	
	0,01 - 99,99 bm	100 - 199,99 bm	od 200 bm	
3 x 1,5mm	22,60	21,10	19,80	
5 x 2mm	28,20	26,30	24,70	
6 x 4mm	43,70	40,70	38,20	
7 x 2,5mm	31,60	29,50	27,70	
10 x 3mm	49,70	46,40	43,50	
12 x 4mm	66,20	61,80	57,90	
14 x 5mm	96,30	89,90	84,30	
20 x 5mm	136,90	127,80	119,80	
17 x 6mm	143,90	133,40	124,90	
20 x 7mm	159,40	148,80	139,50	



# SILENTBLÖCKE



Schwingungsdämpfende Gummimetallemente (Silentblöcke) werden als Bestandteile für einen flexiblen Halt, zur Stoßdämpfung, zur aktiver sowie passiver Isolierung von Quer- und Vertikalschwingungen, zur Lärmdämmung, Kraftübertragung, Schutzsitz, usw. eingesetzt.

Silentblöcke haben für die Montage eine Schraube mit einem Außen- oder Innengewinden, sowie auch Kombinationen einzelner Halterungsmöglichkeiten.

Für die Einfachheit unterscheiden wir Silentblöcke nach den Halterungsmöglichkeiten in fünf Typen:

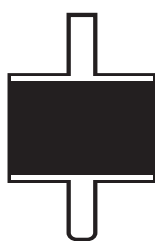

**Typ A**  
beidseitiges  
Außengewinde



**Typ B**  
beidseitiges  
Außengewinde / Innengewinde



**Typ C**  
beidseitiges  
Innengewinde



**Typ D**  
einseitiges  
Außengewinde



**Typ E**  
einseitiges  
Innengewinde

Silentblöcke werden aus Elastomeren in einer breiten Palette von Formen, Durchmessern und Längen hergestellt. Am meisten werden zylindrische Silentblöcke verwendet.



# SILENTBLÖCKE - TYP A

## BEIDSEITIGES AUßENGEWINDE

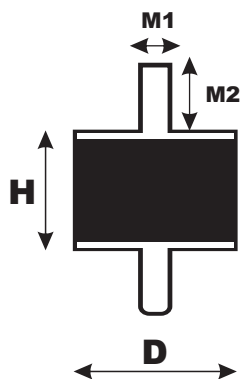

D	H	M1xM2	1 - 9 ks	10 - 24 ks	25 - 49 ks	50 - 99 ks	100 - 199 ks
15	8	M4x10	11,10	8,90	8,10	7,40	6,90
	10	M4x10	12,00	9,60	8,80	8,00	7,40
	15	M4x10	12,00	9,60	8,80	8,00	7,40
	20	M4x10	12,20	9,70	8,80	8,10	7,50
	30	M4x10	12,30	9,80	9,00	8,20	7,60
20	8	M6x18	15,30	12,30	11,20	10,20	9,40
	10	M6x18	15,70	12,50	11,40	10,50	9,70
	13,5	M6x18	15,90	12,70	11,60	10,60	9,80
	15	M6x18	16,30	13,00	11,80	10,80	10,00
	20	M6x18	17,20	13,70	12,50	11,40	10,60
	25	M6x18	17,70	14,20	12,90	11,80	10,90
	30	M6x18	18,30	14,60	13,30	12,20	11,30
25	10	M6x18	22,30	17,80	16,20	14,80	13,70
	15	M6x18	24,10	19,30	17,50	16,10	14,80
	20	M6x18	24,50	19,60	17,90	16,40	15,10
	25	M6x18	24,90	19,90	18,10	16,60	15,30
	30	M6x18	25,80	20,60	18,80	17,20	15,90
30	15	M6x18	26,40	23,10	20,90	19,40	18,20
	20	M6x18	33,20	26,50	24,10	22,10	20,40
	25	M6x18	34,70	27,70	25,20	23,10	21,30
	30	M6x18	36,10	28,90	26,30	24,10	22,20
40	20	M8x23	37,60	30,10	27,40	25,10	23,10
	30	M8x23	42,50	34,00	30,90	28,30	26,20
	40	M8x23	50,50	40,40	36,70	33,60	31,00
	50	M10x28	61,30	49,00	44,50	40,80	37,70
50	25	M10x28	64,10	51,30	46,60	42,70	39,40
	30	M10x28	68,50	54,80	49,80	45,70	42,20
	35	M10x28	72,00	57,60	52,40	48,00	44,30
	40	M10x28	75,80	60,60	55,10	50,50	46,60
	45	M10x28	78,80	63,00	57,30	52,50	48,50
	50	M10x28	83,20	66,50	60,50	55,50	51,20
60	30	M12x37	101,00	80,80	73,50	67,30	62,20
	40	M12x37	103,40	82,70	75,20	68,90	63,60
70	35	M12x32	123,20	98,50	89,60	82,10	75,80
	45	M12x32	130,60	104,50	95,00	87,00	80,30
75	25	M12x37	158,00	126,40	114,90	105,30	97,20
	40	M12x37	181,80	145,50	132,20	121,20	111,90
	50	M12x37	200,80	160,60	146,00	133,90	123,60
	55	M12x37	214,80	171,80	156,20	143,20	132,20
100	30	M16x42	326,60	261,30	237,50	217,70	201,00
	40	M16x42	337,00	269,60	245,10	224,70	207,40
	50	M16x42	369,20	295,40	268,50	246,10	227,20
	55	M16x42	380,90	304,70	277,00	253,90	234,40
	60	M16x42	395,50	316,40	287,60	263,60	243,40
	75	M16x42	439,30	351,50	319,50	292,90	270,30
150	45	M16x42	936,90	749,50	681,40	624,60	576,60
	50	M16x42	975,00	780,00	709,10	650,00	600,00
	55	M16x42	1004,20	803,40	730,30	669,50	618,00
	60	M16x42	1039,20	831,40	755,80	692,80	639,50
	75	M16x42	1138,50	910,80	828,00	759,00	700,60

# SILENTBLÖCKE - TYP B

## BEIDSEITIGES AUßENGEWINDE / INNENGEWINDE

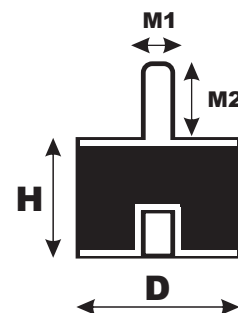

D	H	M1xM2	1 - 9 ks	10 - 24 ks	25 - 49 ks	50 - 99 ks	100 - 199 ks
15	8	M4x10	18,30	14,60	13,30	12,20	11,30
	10	M4x10	24,30	15,30	13,90	12,70	11,70
	15	M4x10	19,10	15,30	13,90	12,70	11,70
	20	M4x10	19,30	15,50	14,00	12,90	11,90
	30	M4x10	19,40	15,50	14,10	13,00	12,00
20	8	M6x18	25,10	20,10	18,30	16,70	15,50
	10	M6x18	25,50	20,40	18,50	17,00	15,70
	13,5	M6x18	25,70	20,50	18,70	17,10	15,80
	15	M6x18	26,00	20,80	18,90	17,30	16,00
	20	M6x18	26,90	21,50	19,60	18,00	16,60
	25	M6x18	27,50	22,00	20,00	18,30	16,90
	30	M6x18	28,10	22,50	20,40	18,70	17,30
25	10	M6x18	31,50	25,20	22,90	21,00	19,40
	15	M6x18	33,20	26,50	24,10	22,10	20,40
	20	M6x18	33,60	26,90	24,50	22,40	20,80
	25	M6x18	34,10	27,30	24,80	22,70	21,00
	30	M6x18	34,60	28,00	25,50	23,30	21,50
30	15	M6x18	37,10	31,50	29,50	25,50	22,50
	20	M6x18	40,50	32,40	29,40	27,00	24,90
	25	M6x18	41,80	33,50	30,40	27,90	25,70
	30	M6x18	43,30	34,60	31,50	28,90	26,60
	40	M6x18	46,30	37,00	33,60	30,80	28,50
40	20	M8x23	44,30	35,50	32,20	29,50	27,30
	30	M8x23	49,50	39,60	36,00	33,00	30,50
	40	M8x23	58,40	46,70	42,50	38,90	35,90
50	20	M10x28	68,30	54,60	49,70	45,50	42,00
	25	M10x28	71,30	57,00	51,80	47,50	43,80
	30	M10x28	75,60	60,50	55,00	50,40	46,50
	35	M10x28	79,10	63,30	57,50	52,70	48,70
	40	M10x28	83,00	66,40	60,30	55,30	51,00
	45	M10x28	85,80	68,60	62,40	57,20	52,80
	50	M10x28	90,20	72,20	65,60	60,20	55,50
60	30	M12x37	105,60	84,50	76,80	70,40	65,00
	40	M12x37	108,00	86,40	78,50	72,00	66,40
70	35	M12x32	127,80	102,30	93,00	85,20	78,70
	45	M12x32	135,10	108,10	98,30	90,10	83,10
75	25	M12x37	162,50	130,00	118,20	108,30	100,00
	40	M12x37	186,50	149,20	135,60	124,30	114,80
	50	M12x37	205,50	164,40	149,40	137,00	126,40
	55	M12x37	217,70	174,20	158,30	145,20	134,00
100	30	M16x42	328,80	263,00	239,10	219,20	202,30
	40	M16x42	339,20	271,40	246,70	226,10	208,70
	50	M16x42	371,30	297,00	270,00	247,50	228,50
	55	M16x42	383,00	306,40	278,50	255,30	235,70
	60	M16x42	397,60	318,10	289,20	265,10	244,70
	75	M16x42	441,40	353,10	321,00	294,20	271,60
150	45	M16x42	939,10	751,30	683,00	626,10	577,90
	50	M16x42	977,00	781,60	710,60	651,40	601,30
	55	M16x42	1006,30	805,00	731,80	670,80	619,20
	60	M16x42	1041,30	833,00	757,30	694,20	640,80
	75	M16x42	1140,60	912,50	829,50	760,40	701,90

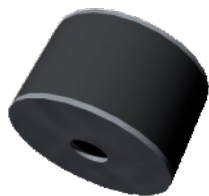
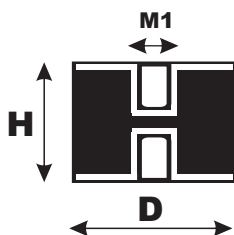

# SILENTBLÖCKE - TYP C

## BEIDSEITIGES INNENGEWINDE

D	H	M1	1 - 9 ks	10 - 24 ks	25 - 49 ks	50 - 99 ks	100 - 199 ks
15	8	M4	25,30	20,30	18,40	16,90	15,60
	10	M4	26,30	21,00	19,10	17,50	16,20
	15	M4	26,30	21,00	19,10	17,50	16,20
	20	M4	26,40	21,10	19,20	17,60	16,20
	30	M4	26,50	21,20	19,30	17,70	16,30
20	8	M6	34,90	27,90	25,40	23,30	21,50
	10	M6	35,20	28,20	25,60	23,50	21,70
	13,5	M6	35,50	28,40	25,80	23,60	21,80
	15	M6	35,80	28,60	26,00	23,90	22,00
	20	M6	36,70	29,40	26,70	24,50	22,60
	25	M6	37,30	29,80	23,80	24,80	22,90
	30	M6	37,80	30,30	27,50	25,20	23,30
25	10	M6	40,70	32,50	29,60	27,10	25,10
	15	M6	42,40	33,90	30,80	28,30	26,10
	20	M6	42,80	34,30	31,20	28,60	26,40
	25	M6	43,30	34,60	31,50	28,90	26,60
30	30	M6	44,20	35,40	32,10	29,50	27,20
	15	M6	45,30	36,30	32,90	29,81	27,40
	20	M6	47,60	38,10	34,60	31,70	29,30
	25	M6	49,10	39,30	35,70	32,70	30,20
40	30	M6	50,60	40,50	36,80	33,70	31,10
	40	M6	53,40	42,70	38,80	35,60	32,90
	20	M8	51,10	40,90	37,20	34,10	31,50
	30	M8	56,70	45,40	41,20	37,80	34,90
50	40	M8	66,40	53,10	48,30	44,20	40,80
	20	M10	75,50	60,40	54,90	50,30	46,40
	25	M10	78,30	62,60	56,90	52,20	48,20
	30	M10	82,70	66,20	60,20	55,20	50,90
	35	M10	86,30	69,00	62,70	57,50	53,10
	40	M10	90,00	72,00	65,50	60,00	55,40
	45	M10	93,00	74,40	67,60	62,00	57,20
60	50	M10	97,30	77,80	70,70	64,80	59,90
	30	M12	110,20	88,20	80,20	73,50	67,80
70	40	M12	112,60	90,10	81,90	75,10	69,30
	35	M12	130,40	105,90	96,30	88,30	81,50
75	45	M12	139,70	111,70	101,60	93,10	86,00
	25	M12	167,00	133,60	121,50	111,40	102,80
	40	M12	191,00	152,80	138,90	127,30	117,60
	50	M12	210,00	168,00	152,70	140,00	129,20
	55	M12	220,70	176,50	160,50	158,00	135,80
100	30	M16	330,80	264,60	240,60	220,50	203,60
	40	M16	341,30	273,00	248,20	227,50	210,00
	50	M16	373,40	298,70	271,60	248,90	229,80
	55	M16	385,10	308,10	280,10	256,70	237,00
	60	M16	399,70	319,70	290,70	266,40	245,90
	75	M16	443,50	354,80	322,60	295,70	272,90
150	45	M16	941,10	752,90	684,50	627,40	579,20
	50	M16	979,10	783,30	721,10	652,70	602,50
	55	M16	1008,30	806,60	733,30	672,20	620,50
	60	M16	1043,40	834,70	758,80	695,60	642,10
	75	M16	1142,70	914,20	831,10	761,80	703,20

# SILENTBLÖCKE - TYP D

## EINSEITIGES AUßENGEWINDE

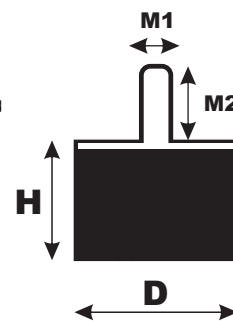

D	H	M1xM2	1 - 9 ks	10 - 24 ks	25 - 49 ks	50 - 99 ks	100 - 199 ks
15	8	M4x10	11,30	9,00	8,20	7,50	6,90
	10	M4x10	12,20	9,70	8,80	8,10	7,50
	15	M4x10	12,20	9,70	8,80	8,10	7,50
	20	M4x10	12,30	9,80	8,90	8,20	7,60
	30	M4x10	12,40	9,90	9,00	8,30	7,60
20	8	M6x18	14,90	11,90	10,80	9,90	9,20
	10	M6x18	15,10	12,10	11,00	10,10	9,30
	13,5	M6x18	15,50	12,40	11,20	10,70	9,50
	15	M6x18	15,70	12,50	11,40	10,50	9,70
	20	M6x18	16,60	13,30	12,10	11,10	10,20
	25	M6x18	17,20	13,70	12,50	11,40	10,60
	30	M6x18	17,70	14,20	12,90	11,30	10,90
25	10	M6x18	19,20	15,40	14,00	12,80	11,80
	15	M6x18	20,70	16,50	15,00	13,80	12,70
	20	M6x18	20,90	16,70	15,20	13,90	12,90
	25	M6x18	21,80	17,50	15,90	14,50	13,40
	30	M6x18	22,70	18,20	16,50	15,20	14,00
30	15	M6x18	23,60	19,90	18,40	17,30	14,50
	20	M6x18	26,40	21,10	19,20	17,60	16,20
	25	M6x18	27,80	22,30	20,20	18,60	17,10
	30	M6x18	29,30	23,50	21,30	19,50	18,70
	40	M6x18	32,30	25,80	23,50	21,50	19,90
40	20	M8x23	28,00	22,40	20,30	18,60	17,20
	30	M8x23	32,60	26,10	23,70	21,70	20,10
	40	M8x23	44,10	35,30	32,10	29,40	27,10
50	20	M10x28	52,40	41,90	38,10	34,90	32,20
	25	M10x28	55,20	44,20	40,20	36,80	34,00
	30	M10x28	59,70	47,70	43,40	39,80	36,70
	35	M10x28	63,20	50,50	46,00	42,10	38,90
	40	M10x28	66,90	53,50	48,70	44,60	41,20
	45	M10x28	69,90	55,90	50,80	46,60	43,00
	50	M10x28	74,20	59,40	54,00	49,50	45,70
60	30	M12x37	77,20	61,70	56,10	51,40	47,50
	40	M12x37	78,00	62,40	56,70	52,00	48,00
70	35	M12x32	98,90	79,10	71,90	65,90	60,80
	45	M12x32	106,10	84,90	77,20	70,80	65,30
75	25	M12x37	134,80	107,80	98,00	89,80	82,90
	40	M12x37	158,80	123,70	115,50	105,80	97,70
	50	M12x37	177,70	142,20	129,30	118,50	109,40
	55	M12x37	188,40	150,70	137,00	125,60	115,90
100	30	M16x42	268,50	214,80	195,30	179,00	165,20
	40	M16x42	289,90	231,90	210,80	193,30	178,40
	50	M16x42	321,90	257,50	234,10	214,60	198,10
	55	M16x42	333,60	266,90	242,60	222,40	205,30
	60	M16x42	348,30	278,60	253,30	232,20	214,30
	75	M16x42	392,00	313,60	285,10	261,40	241,30
150	45	M16x42	717,20	573,70	521,60	478,10	441,30
	50	M16x42	755,10	604,10	549,20	503,40	464,70
	55	M16x42	784,30	627,50	570,40	522,90	482,70
	60	M16x42	846,40	655,50	596,00	546,30	504,30
	75	M16x42	918,80	735,00	668,20	612,50	565,40



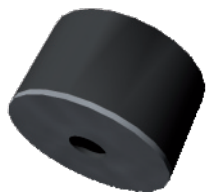
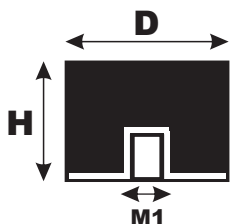

# SILENTBLÖCKE- TYP E

## EINSEITIGES INNENGEWINDE

D	H	M1	1 - 9 ks	10 - 24 ks	25 - 49 ks	50 - 99 ks	100 - 199 ks
15	8	M4	18,40	14,70	13,40	12,30	11,60
	10	M4	19,20	15,40	14,00	12,80	11,80
	15	M4	19,20	15,40	14,00	12,80	11,80
	20	M4	19,30	15,50	14,00	12,90	11,90
	30	M4	19,50	15,60	14,20	13,00	12,00
20	8	M6	24,70	19,70	17,90	16,40	15,20
	10	M6	24,90	19,90	18,10	16,60	15,30
	13,5	M6	25,20	20,20	18,30	16,80	15,50
	15	M6	25,50	20,40	18,50	17,00	15,70
	20	M6	26,40	21,10	19,20	17,60	16,20
	25	M6	26,90	21,50	19,60	18,00	16,60
	30	M6	27,50	22,00	20,00	18,30	16,90
25	10	M6	28,30	22,60	20,60	18,90	17,40
	15	M6	29,90	23,90	21,70	19,90	18,40
	20	M6	30,10	24,10	21,90	20,10	18,50
	25	M6	31,00	24,80	22,60	20,70	19,10
	30	M6	31,80	25,50	23,10	21,20	19,60
30	15	M6	31,20	25,20	23,50	22,10	19,80
	20	M6	33,50	26,80	24,40	22,30	20,60
	25	M6	35,00	28,00	25,50	23,30	21,50
	30	M6	36,50	29,20	26,50	24,30	22,40
	40	M6	39,40	31,50	28,70	26,30	24,30
40	20	M8	34,80	27,80	25,30	23,20	21,40
	30	M8	39,70	31,70	28,80	26,40	24,40
	40	M8	52,00	41,60	37,90	34,70	32,00
50	20	M10	59,40	47,50	43,20	39,60	35,70
	25	M10	62,40	49,90	45,40	41,60	38,40
	30	M10	66,70	53,40	48,50	44,50	41,00
	35	M10	70,20	56,20	51,10	46,80	43,20
	40	M10	74,10	59,30	53,90	49,40	46,00
	45	M10	76,90	61,50	56,00	51,30	47,30
	50	M10	81,40	65,10	59,20	54,20	50,10
60	30	M12	81,70	65,40	59,40	54,50	50,30
	40	M12	82,60	66,10	60,10	55,10	50,80
70	35	M12	103,40	81,50	75,20	68,90	63,60
	45	M12	110,80	88,60	80,60	73,90	68,20
75	25	M12	139,40	111,50	101,40	93,00	85,80
	40	M12	163,40	130,70	118,80	108,90	100,60
	50	M12	182,40	145,90	132,60	121,60	112,20
	55	M12	191,40	153,10	139,20	127,60	117,80
100	30	M16	270,70	216,50	196,90	180,50	166,60
	40	M16	291,90	233,50	212,30	194,60	179,70
	50	M16	324,10	259,30	235,70	216,10	199,40
	55	M16	335,80	268,60	244,20	223,90	206,60
	60	M16	350,60	280,30	254,80	233,60	215,60
	75	M16	394,20	315,40	286,70	262,80	242,60
150	45	M16	719,20	575,40	523,10	479,50	442,60
	50	M16	757,30	605,80	550,70	504,80	466,00
	55	M16	786,50	629,20	572,00	524,30	484,00
	60	M16	821,50	657,20	597,40	547,70	505,50
	75	M16	920,80	736,60	669,70	613,90	566,60

Rundschnüre sind aufgrund ihrer mechanischen, physikalischen und chemischen Eigenschaften sowie der dauerhaften Verformung für Dichtungen von Konstruktions- und Bauteilen in verschiedenen Industriebereichen ausgelegt. Sie zeichnen durch ihre Luftdichte und praktisch nicht vorhandener Saugfähigkeit aus. In einem dem Material entsprechendem Temperaturbereich sind sie Witterungsbeständig, ohne Änderungen ihrer physikalischen, mechanischen und chemischen Eigenschaften.

Wir stellen Dichtungs-Rundschnüren aus folgenden Materialien her:

- Gummi (EPDM, NBR, VITON, CR, SILIKON)
- mikroporöse Gummi (CR, EPDM, NBR, SILIKON)
- weitere Materialien auf Anfrage

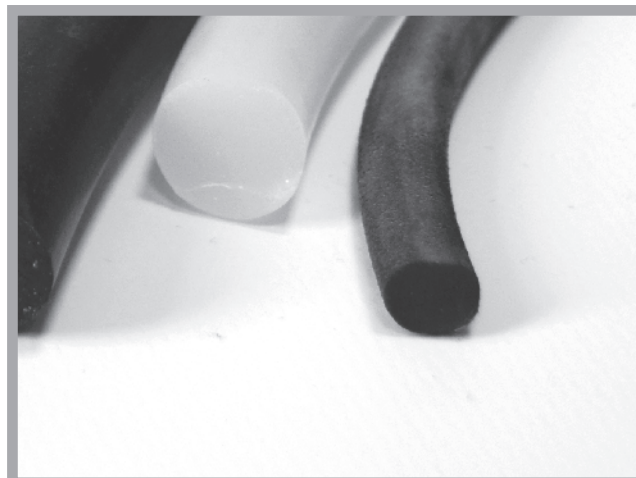
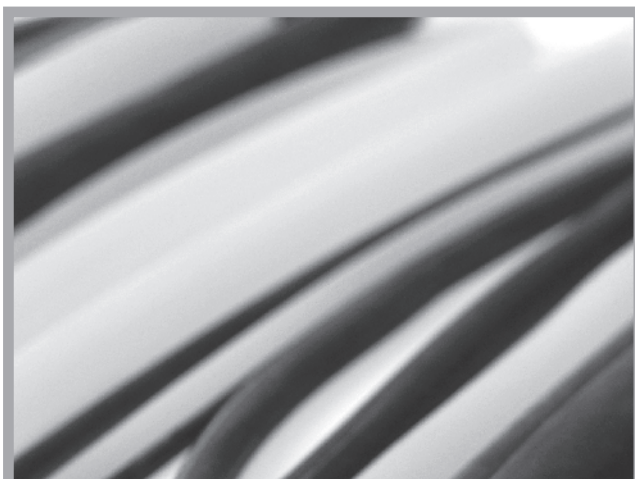

# RUNDSCHNÜRE

## SILIKON / FPM / EPDM / NBR / MIKROPORÖSE

Silikon -Rundsnüre	Preis				
⊗ Durchmesser	0,01 - 49,99 bm	50,00 - 99,99 bm	100,00 - 249,99 bm	250,00 - 499,99 bm	od 500,00 bm
3 mm	7,08	5,31	3,54	3,54	3,04
4 mm	9,96	7,97	7,24	6,64	5,69
5 mm	15,27	12,22	11,11	10,18	8,73
6 mm	17,53	15,94	14,61	13,49	12,52
7 mm	18,59	16,90	15,49	14,30	13,28
8 mm	20,19	18,35	16,82	15,53	14,42
9 mm	25,50	23,18	21,25	19,62	18,21
10 mm	28,49	26,12	24,11	22,39	20,90
11 mm	34,29	31,43	29,01	26,94	25,15
12 mm	37,63	34,74	32,25	30,10	28,22
13 mm	43,83	40,46	37,57	35,06	32,87
14 mm	50,91	47,00	43,64	40,73	38,18
15 mm	58,44	53,94	50,09	46,75	43,83
16 mm	66,85	61,71	57,30	53,48	50,14

FPM -Rundsnüre	Preis			
⊗ Durchmesser	0,01 - 24,99 bm	25,00 - 99,99 bm	100,00 - 199,99 bm	od 200,00 bm
2 mm	19,81	18,28	16,98	15,85
3 mm	35,53	32,79	30,46	28,42
4 mm	59,14	54,60	50,70	47,32
5 mm	89,23	82,36	76,48	71,39
6 mm	120,67	111,39	103,43	96,55
7 mm	160,08	147,77	137,21	128,07
8 mm	207,25	191,31	177,64	165,81
10 mm	321,33	296,61	275,42	257,06
12 mm	397,49	366,91	340,70	317,99
15 mm	620,73	572,98	532,05	496,58

EPDM -Rundsnüre	Preis			
⊗ Durchmesser	0,01 - 49,99 bm	50,00 - 99,99 bm	100,00 - 499,99 bm	od 500,00 bm
2 mm	7,41	5,19	4,32	3,80
3 mm	9,29	6,51	5,42	4,77
4 mm	10,00	7,00	5,83	5,13
5 mm	16,24	11,36	9,47	8,33
6 mm	21,88	15,32	12,76	11,23
7 mm	27,53	19,27	16,06	14,13
8 mm	32,82	22,98	19,15	16,85
9 mm	37,65	26,35	21,96	19,33
10 mm	42,12	29,48	24,57	21,65
12 mm	72,35	50,65	42,21	37,14

# RUNDSCHNÜRE

SILIKON / FPM / EPDM / NBR / MIKROPORÖSE



NBR-Rundschnüre	Preis			
	0,01 - 49,99 bm	50,00 - 99,99 bm	100,00 - 499,99 bm	od 500,00 bm
⊗ Durchmesser				
2 mm	7,41	5,19	4,32	3,80
3 mm	9,29	6,51	5,42	4,77
4 mm	10,00	7,00	5,83	5,13
5 mm	16,24	11,36	9,47	8,33
6 mm	21,88	15,32	12,76	11,23
7 mm	27,53	19,27	16,06	14,13
8 mm	32,82	22,98	19,15	16,85
9 mm	37,65	26,35	21,96	19,33
10 mm	42,12	29,48	24,57	21,65
12 mm	72,35	50,65	42,21	37,14

EPDM-mikroporöse	Preis			
	0,01 - 49,99 bm	50,00 - 99,99 bm	100,00 - 249,99 bm	od 250,00 bm
⊗ Durchmesser				
2 mm	3,47	3,18	2,93	2,72
3 mm	3,81	3,47	3,18	2,93
4 mm	5,08	4,62	4,24	3,91
5 mm	6,35	5,78	5,29	4,89
6 mm	7,06	6,35	5,78	5,29
7 mm	8,05	7,32	6,71	6,19
8 mm	10,59	9,63	8,82	8,14
9mm	13,13	11,94	10,94	10,10
10 mm	16,52	15,05	13,76	12,71
12 mm	21,18	19,25	17,65	16,29
13mm	24,99	22,72	20,82	19,22
14mm	28,80	26,18	24,00	22,15
15 mm	33,04	30,03	27,53	25,41
16mm	37,69	34,27	31,41	29,00
17mm	42,78	38,89	35,65	32,90
18mm	47,86	43,51	39,88	36,81
20mm	58,87	53,52	49,06	45,29
25mm	76,66	69,69	63,88	58,97
30mm	110,54	100,49	92,12	85,03
35mm	150,35	136,68	125,29	115,66
40mm	196,52	178,65	163,76	151,17
45mm	248,61	226,01	207,18	191,21
50mm	307,06	279,14	255,88	236,20

Wir stellen unsere Schläuche aus verschiedenen Materialien und für viele Verwendungsbereiche her. Sie werden aus synthetischem Kautschuk produziert, der Öl- und Witterungsbeständig ist.

Silikon-Schläuche finden ihre Nutzung vor allem in der Nahrungsmittel- und Pharmaindustrie, z.B. für Milch- und Alkoholtransporte.

Unsere Firma beschäftigt sich auch mit der Herstellung von PVC-Schläuchen:

- Garten-Bewässerungsschläuche in verschiedenen Ausführungen
- Einmantelige Schläuche für eine leichte Nutzung in den Bereichen Industrie, Landwirtschaft und Haushalt für Luft- und Wassertransporte.
- Saugschläuche für Landwirtschaft, Industrie, usw

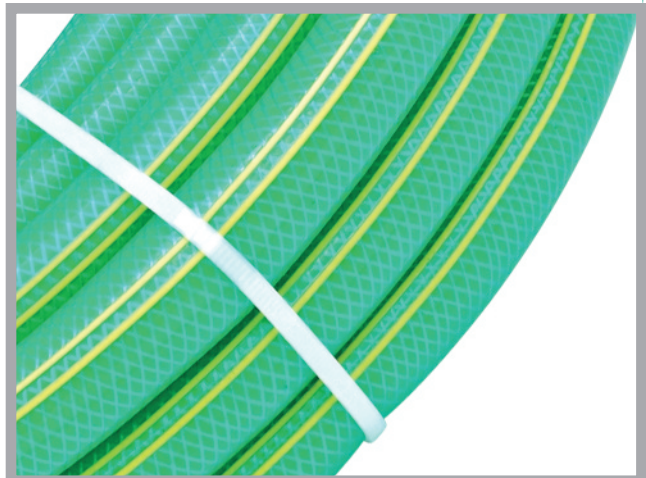
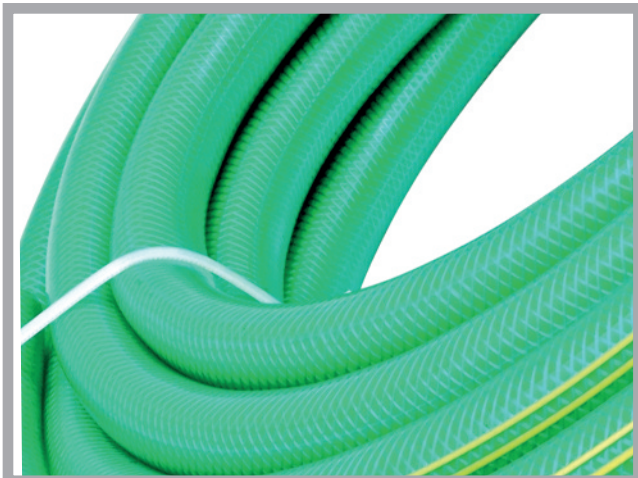

# GARTENSCHLÄUCHE



*....dichtet sofort*

## PVC - GARTENSCHLÄUCHE

**Material:** enthärtetes PVC, schwarze Innenschicht, dunkelgrün mit einem gelben Streifen.

**Nutzung:** Weit verbreiteter Schlauch für die Bewässerung, in der Industrie und im Haushalt für Wasser und Luft. Leicht, flexibel, elastisch, transportabel und ausgezeichnete Anpassungsfähigkeit.

Betriebstemperatur: -5 °C bis +65 °C

Maß	⊘ Innendurchmesser	⊘ Außendurchmesser	Packung	⌚ Arbeitsdruck	⌚ Stördruck	Preis/lm
1/2"	12,7	17,1	25/50bm	10	32	<b>10,90</b>
5/8"	15,9	20,9	25/50bm	10	28	<b>15,80</b>
3/4"	19,0	25,6	25/50bm	10	25	<b>22,00</b>
1"	25,4	34,4	25/50bm	10	18	<b>36,40</b>



## PVC - GEWEBESCHLÄUCHE

**Material:** enthärtetes PVC, transparente Innenschicht, hellgrün oder hell (je nach Angebot)

**Nutzung:** Ein Druckschlauch für Flüssigkeiten und Luft, wird für die Bewässerung, in Gärtnereien, für Wassertransporte in Industrien, in der Landwirtschaft und in Haushalten verwendet. Der Gewebeschlauch ist flexibel, widerstandsfähig, ungiftig und geruchlos.

Betriebstemperatur: -5 °C bis +65 °C

Maß	⊗ Innendurchmesser	⊗ Außendurchmesse	Packung	⌚ Arbeitsdruck	⌚ Stördruck	Preis/lm
<b>5/16"</b>	7,9	12,3	25/50bm	10	35	<b>10,50</b>
<b>3/8"</b>	9,5	13,9	25/50bm	10	32	<b>10,60</b>
<b>1/2"</b>	12,7	17,1	25/50bm	10	32	<b>12,00</b>
<b>5/8"</b>	15,9	20,9	25/50bm	10	28	<b>21,30</b>
<b>3/4"</b>	19,0	24,0	25/50bm	10	25	<b>26,40</b>
<b>1"</b>	25,4	32,0	25/50bm	10	18	<b>37,50</b>
<b>5/4"</b>	31,8	39,0	25/50bm	10	15	<b>59,30</b>

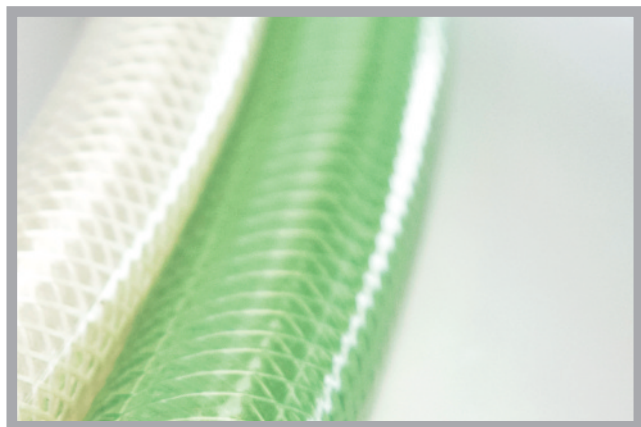

# SAUGSCHLÄUCHE



....dichtet sofort

## PVC - SAUGSCHLÄUCHE MIT PVC-SPIRALE

**Material:** enthärtetes PVC, transparent-grün

**Nutzung:** Bestimmt für das Ansaugen und Ablassen von Wasser und anderen nicht aggressiven Flüssigkeiten. Zur Verwendung in Industrie, Landwirtschaft, Bauwesen und für die Bewässerung. Eine ideale Alternative für Gummischläuche und Metallrohre.

Betriebstemperatur: -5 °C bis +65 °C

Maß	⊗ Innendurchmesser	⊗ Außendurchmesser	Packung	⌚ Arbeitsdruck	⌚ Stördruck		Preis/lm
3/4"	20	23,8	30bm	6	20	AV	<b>19,80</b>
1"	25	29,2	30bm	6	20	AV	<b>23,90</b>
1 1/4"	32	36,4	30bm	6	20	AV	<b>28,80</b>
1 1/2"	38	43,2	30bm	6	20	AV	<b>43,10</b>
2"	50	56	30bm	6	20	AV	<b>64,40</b>
3"	76	80,8	30bm	6	20	AV	<b>128,90</b>
4"	102	118	20bm	3	11	A	<b>188,70</b>
5"	125	140	20bm	3	11	A	<b>290,60</b>
6"	152	170	10bm	2	8	A	<b>425,40</b>
8"	203	225	10bm	2	8	A	<b>590,80</b>

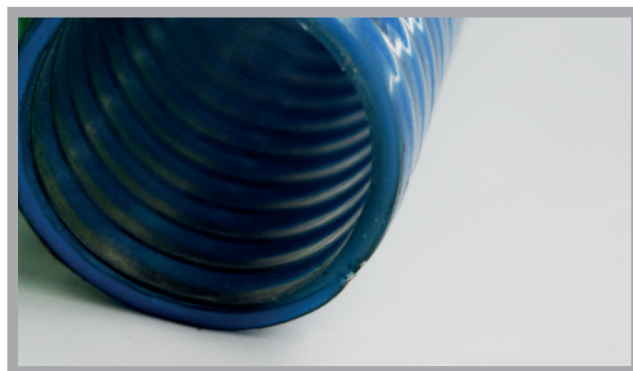
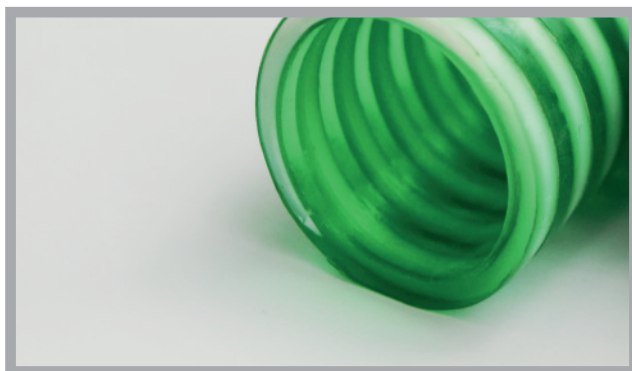
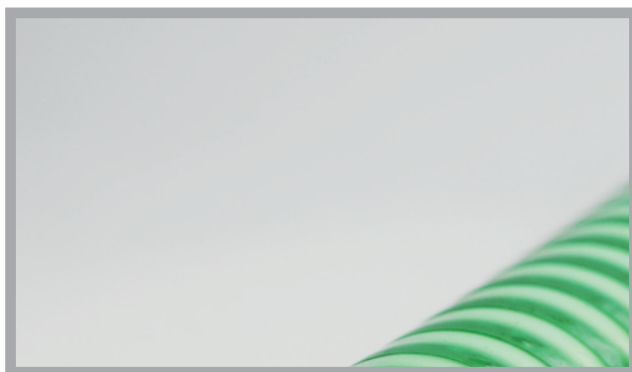



# SCHLÄUCHE MIT STAHLSPIRALE

## PVC - SCHLÄUCHE MIT STAHLSPIRALE

**Material:** enthärtetes PVC

**Použití:** Der Schlauch wird zum Pumpen und Transportieren von Wasser, Öl und Staub in Betrieben in der Landwirtschaft, dem Maschinenbau, der Nahrungsmittelindustrie und der Abwasserleitungen eingesetzt. Der Schlauch für die Nahrungsmittelindustrie wird aus speziellen Materialien hergestellt.

Der Schlauch ist ungiftig, leicht, geruchslos und transparent. Er kann für den Transport von Milch, Getränken, destilliertem Alkohol, Bier, Konfitüren und weiteren Materialien verwendet werden. Man kann auch einen Kupferdraht in den Schlauch einlegen, um statische Elektrizität zu vermeiden und den Nutzer vor Stromschlägen zu schützen. Dieses Produkt dient zum Transport von Flüssigkeiten, Wasser und Luft.

Betriebstemperatur: -5 °C bis +65 °C

Maß	⊗ Innendurchmesser	⊗ Außendurchmesser	Packung	⌚ Arbeitsdruck	⌚ Stördruck		Preis/Im
3/8"	9	14	50bm	4	12	A	15,40
1/2"	12	17	50bm	4	12	A	17,40
5/8"	16	20	50bm	4	12	A	24,40
3/4"	19	25,6	50bm	4	9	A	26,20
1"	25	33	30bm	5	15	AV	26,40
1 1/4"	32	40,2	30bm	5	15	AV	37,50
1 1/2"	38	46,8	30bm	4	12	AV	59,30
2"	51	61,4	30bm	3	9	AV	98,90
3"	63	75	30bm	2	6	AV	197,10
4"	102	110	30bm	1,5	4,5	A	326,20
5"	125	141	20bm	1,5	4,5	A	477,30
6"	152	166	10bm	1,5	4,5	A	715,90
7"	180	196	10bm	1,5	4,5	A	805,70
8"	200	224	10bm	1,5	4,5	A	1.055,30

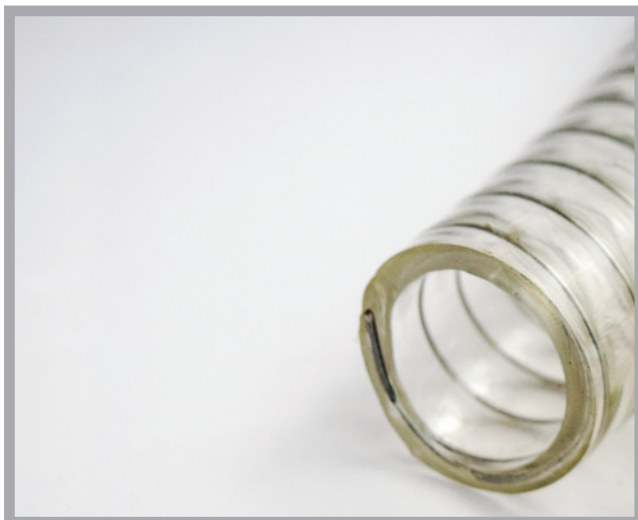

# EINMANTELIGE SCHLÄUCHE



....dichtet sofort

## PVC - EINMANTELIGE SCHLÄUCHE

**Material:** enthärtetes PVC, transparent / klar

**Použití:** Dieses Produkt dient zum Transport von Flüssigkeiten, Wasser und Luft.

Für den einfachen Einsatz im Bereich der Industrie, Landwirtschaft und des Haushaltes.

Dieser Schlauch ist flexibel, beständig, ungiftig und geruchslos.

Betriebstemperatur: -5 °C bis +65 °C

⊕ Innendurchmesser	⊕ Außendurchmesser	Packung	⌚ Arbeitsdruck	⌚ Stördruck		Preis/lm
3	5	100bm	4	12	A	<b>2,80</b>
4	7	100bm	4	12	AV	<b>6,20</b>
5	8	100bm	4	12	AV	<b>6,30</b>
6	9	100bm	4	9	AV	<b>6,40</b>
7,9	10,9	100bm	5	15	AV	<b>6,70</b>
9,5	12,5	100bm	5	15	AV	<b>8,20</b>
12,5	15,9	50bm	4	12	AV	<b>12,20</b>
15,9	19,7	50bm	2	6	AV	<b>15,95</b>
19	23	50bm	1,5	4,5	AV	<b>20,50</b>
25,4	30,8	25bm	1,5	4,5	AV	<b>34,50</b>
34	36	40bm	1,5	4,5	A	<b>36,20</b>
38	43	40bm	1,5	4,5	A	<b>39,20</b>
51	57	40bm	1,5	4,5	A	<b>68,80</b>

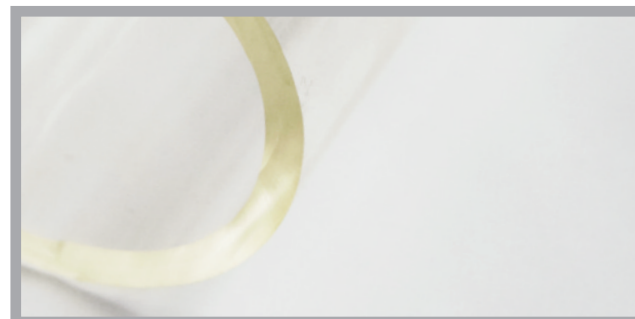
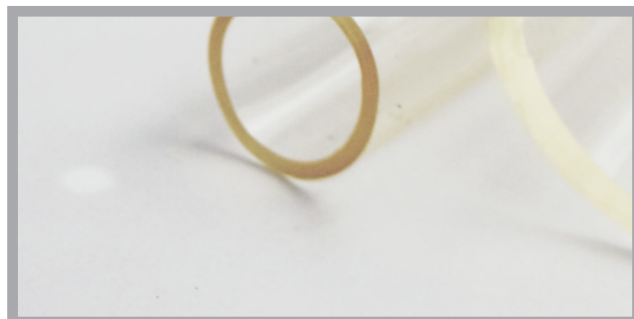
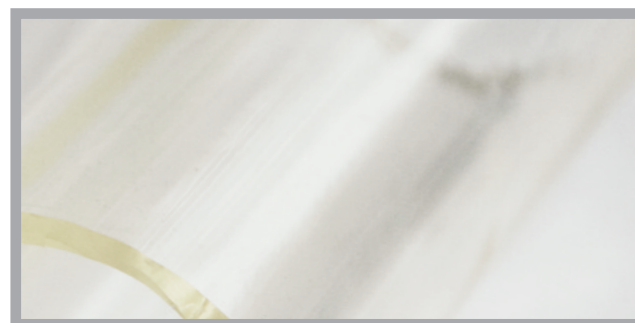



Silikonschlauch 60 +/- 5Sh., transp.					
Maß	Preis				
	0,01 - 49,99 lm	50,00 - 99,99 lm	100,00 - 249,99 lm	250,00 - 499,99 lm	od 500,00 lm
1 x 1mm	4,60	3,70	3,10	2,70	2,50
2 x 1mm	7,30	5,80	4,90	4,20	3,90
3 x 1mm	10,00	8,00	6,60	5,70	5,30
4 x 1mm	12,00	9,60	8,00	6,80	6,40
5 x 1mm	16,60	11,70	9,70	8,30	7,80
6 x 1mm	17,30	13,80	11,50	9,90	9,20
7 x 1mm	19,30	15,40	12,80	11,00	10,30
8 x 1mm	21,90	17,50	14,60	12,50	11,70
9 x 1mm	24,60	19,70	16,40	14,00	13,10
10 x 1mm	17,30	13,80	11,50	9,90	9,20
11 x 1mm	19,30	15,40	12,80	11,00	10,30
12 x 1mm	20,60	16,50	13,70	11,80	11,00
Maß	0,01 - 49,99 lm	50,00 - 99,99 lm	100,00 - 249,99 lm	250,00 - 499,99 lm	od 500,00 lm
2 x 1,5mm	12,60	10,10	8,40	7,20	6,70
3 x 1,5mm	16,60	13,30	11,10	9,50	8,90
4 x 1,5mm	19,90	15,90	13,30	11,40	10,60
5 x 1,5mm	23,90	19,10	15,90	13,70	12,80
6 x 1,5mm	17,30	13,80	11,50	9,90	9,20
7 x 1,5mm	19,90	15,90	13,30	11,40	10,60
8 x 1,5mm	22,60	18,10	15,10	12,90	12,00
9 x 1,5mm	24,60	19,70	16,40	14,00	13,10
10 x 1,5mm	27,20	21,80	18,20	15,60	14,50
11 x 1,5mm	29,20	23,40	19,50	16,70	15,60
12 x 1,5mm	31,90	25,50	21,30	18,20	17,00
Maß	0,01 - 49,99 lm	50,00 - 99,99 lm	100,00 - 249,99 lm	250,00 - 499,99 lm	od 500,00 lm
2 x 2mm	12,60	10,10	8,40	7,20	6,70
3 x 2mm	15,90	12,80	10,60	9,10	8,50
4 x 2mm	18,60	14,90	12,40	10,60	9,90
5 x 2mm	21,90	17,50	14,60	12,50	11,70
6 x 2mm	25,20	20,20	16,80	14,40	13,50
7 x 2mm	27,90	22,30	18,60	15,90	14,90
8 x 2mm	31,20	25,00	20,80	17,80	16,60
9 x 2mm	34,50	27,60	23,00	19,70	18,40
10 x 2mm	37,90	30,30	25,20	21,60	20,20
11 x 2mm	40,50	32,40	27,00	23,10	21,60



# GUMMIKLINEN FÜR SCHAREN

Gummiklinken für Scharen		Cena				
Maß	↔ Länge max. mm	0,1 - 39 lm	40 - 99 lm	100 - 199 lm	200 - 499 lm	od 500 lm
70x40 mm	10.000 mm	<b>340,10</b>	<b>315,80</b>	<b>294,80</b>	<b>276,40</b>	<b>260,10</b>
80x20 mm	10.000 mm	<b>202,10</b>	<b>187,70</b>	<b>175,20</b>	<b>164,20</b>	<b>154,60</b>
100x20 mm	10.000 mm	<b>251,20</b>	<b>233,30</b>	<b>217,70</b>	<b>204,10</b>	<b>192,10</b>
120x30 mm	10.000 mm	<b>439,70</b>	<b>408,30</b>	<b>381,00</b>	<b>357,20</b>	<b>336,20</b>
120x40 mm	10.000 mm	<b>579,40</b>	<b>538,00</b>	<b>502,20</b>	<b>470,80</b>	<b>443,10</b>
130x30 mm	10.000 mm	<b>475,90</b>	<b>441,90</b>	<b>412,50</b>	<b>386,70</b>	<b>363,90</b>
140x50 mm	10.000 mm	<b>836,80</b>	<b>777,10</b>	<b>725,30</b>	<b>679,90</b>	<b>639,90</b>
180x50 mm	10.000 mm	<b>1.067,30</b>	<b>991,10</b>	<b>925,00</b>	<b>869,20</b>	<b>816,20</b>
200x20 mm	10.000 mm	<b>493,20</b>	<b>457,90</b>	<b>427,40</b>	<b>400,70</b>	<b>377,10</b>
200x40 mm	10.000 mm	<b>980,60</b>	<b>910,60</b>	<b>849,90</b>	<b>796,70</b>	<b>749,90</b>
200x50 mm	10.000 mm	<b>1.233,20</b>	<b>1.145,10</b>	<b>1.068,70</b>	<b>1.001,90</b>	<b>94,00</b>
230x50 mm	10.000 mm	<b>1.606,50</b>	<b>1.491,70</b>	<b>1.392,30</b>	<b>1.305,30</b>	<b>1.228,50</b>
230x40 mm	10.000 mm	<b>1.195,60</b>	<b>1.110,20</b>	<b>1.036,20</b>	<b>971,40</b>	<b>914,30</b>
250x50 mm	10.000 mm	<b>1.482,20</b>	<b>1.376,30</b>	<b>1.284,60</b>	<b>1.204,30</b>	<b>1.133,40</b>
250x60 mm	10.000 mm	<b>1.786,60</b>	<b>1.659,00</b>	<b>1.548,40</b>	<b>1.451,60</b>	<b>1.366,20</b>

Material: SBR, 4x Textileinlage

Härte: 70 +/-5 Sh.

Farbe: schwarz

Dehnbarkeit: >400-500 %

Festigkeit: 9-11 Mpa

Bemerkung:

- abriebfestes Gummi
- Länge bis 10.000 mm
- Bei Bedarf liefern wir Ihnen Klingen mit Löchern
- Die Länge kann nach Wunsch geschnitten werden

Weitere Materialien auf konkrete Anfragen (PU, EPDM, usw.)

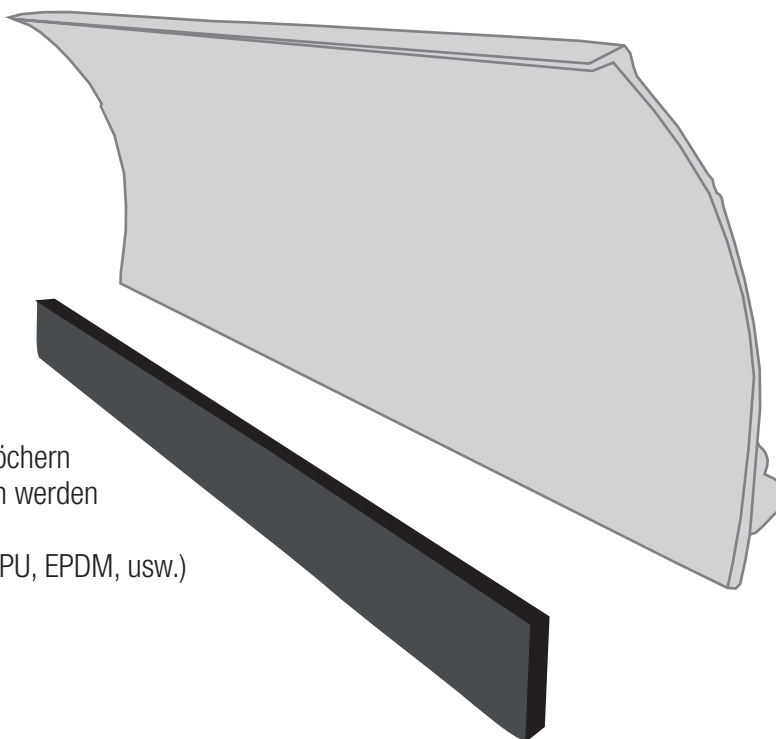

# PVC-STREIFENVORHÄNGE



PVC-Streifenvorhänge werden als durchsichtige Blenden zur Trennung von Lager- und Produktionshallen, Garagen oder anderen Räumlichkeiten eingesetzt. Sie eignen sich insbesondere aus Sicherheits-, Lärm-, oder Wärmedämmungs- und Hygienegründen.

Die PVC-Streifenvorhänge müssen sich gegenseitig überdecken, um Zugluft oder Wärmeverluste zu verhindern. Sie zeichnen sich durch eine hohe Abriebfestigkeit aus.

Die Transparenz von PVC-Streifenvorhängen verbessert die Lichtverhältnisse, wodurch die Beleuchtungskosten gesenkt werden.

Material: enthärtetes durchsichtiges PVC

Betriebstemperatur: -20 °C / +60 °C

PVC-Streifenvorhänge	Preis			
	0,01 - 9,99 lm	10 - 29,99 lm	25 - 99,99 lm	nad 100 lm
Maß				
100 x 2 mm	<b>34,60</b>	<b>29,90</b>	<b>28,10</b>	<b>26,40</b>
200 x 2 mm	<b>66,80</b>	<b>57,90</b>	<b>54,30</b>	<b>51,10</b>
300 x 2 mm	<b>99,10</b>	<b>85,90</b>	<b>80,50</b>	<b>75,80</b>
100 x 3 mm	<b>55,40</b>	<b>48,00</b>	<b>45,00</b>	<b>42,40</b>
200 x 3 mm	<b>103,40</b>	<b>89,60</b>	<b>84,00</b>	<b>79,10</b>
300 x 3 mm	<b>154,00</b>	<b>133,50</b>	<b>125,10</b>	<b>117,80</b>
400 x 3 mm	<b>204,50</b>	<b>177,30</b>	<b>166,20</b>	<b>156,40</b>

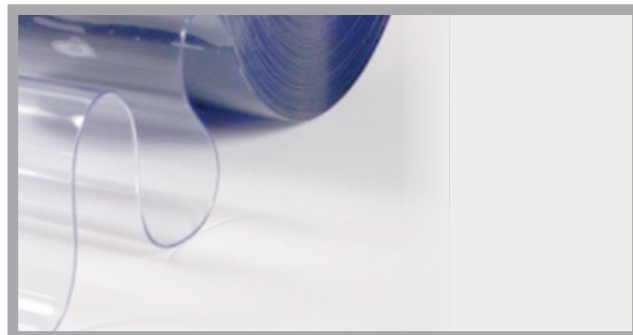
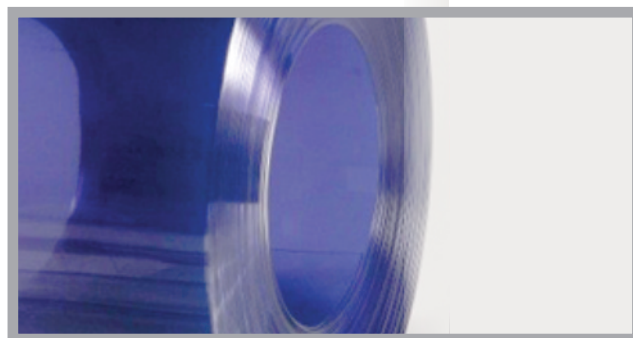

# WAGENHEBER-GUMMIAUFLAGEN

Wir stellen verschiedene Sorten von Gummiauflagen für Handwagenheber sowie für Wagenheber von Autowerkstätten aus hochwertigem Gummi her, die das Risiko einer Beschädigung der Schwelle des Fahrzeuges minimalisieren.

Der Vorteil ist die lange Nutzungsdauer und Elastizität.

In unserem Sortiment befinden sich sowohl anziehbare Auflagen in verschiedenen Formen, als auch Auflagen mit Schrauben oder Gummistiften.

**anziehba- Ø 115 mm**



**anziehbar-quadratisch- 118 mm**



**mit Löchern für Schrauben M6 - Ø 125 mm**



**2x Schraube M6 - Ø 110 mm**



**2x Schraube M6 mit Vertiefung - Ø 110 mm**



**mit Gummistiften und einem Loch - Ø 140 mm**



**mit drei Gummistiften - Ø 146 mm**



**ein Loch für eine Schraube 13mm- Ø 140 mm**



**einsetzendes U-Profil - klein - 120 mm**



**einsetzendes U-Profil - groß- 120 mm**



# HYDRAULIKDICHTUNGEN



Wir bieten Ihnen Maßanfertigungen von Dichtungen für Hydraulikmaschinen an. Unsere Hydraulikdichtungen fertigen wir kundenspezifisch an. Dazu bieten wir auch eine fachliche Beratung und Serviceleistungen nach Ihrem Wunsch an.

*...dichtet sofort*

- Maßanfertigungen von Dichtungen
- eigene Produktion
- umfangreiche persönliche Beratung und Serviceleistungen
- Sonderanfertigungen und spezielle technische Lösungen

*...technisch*

HYDRAULIKDICHTUNGEN

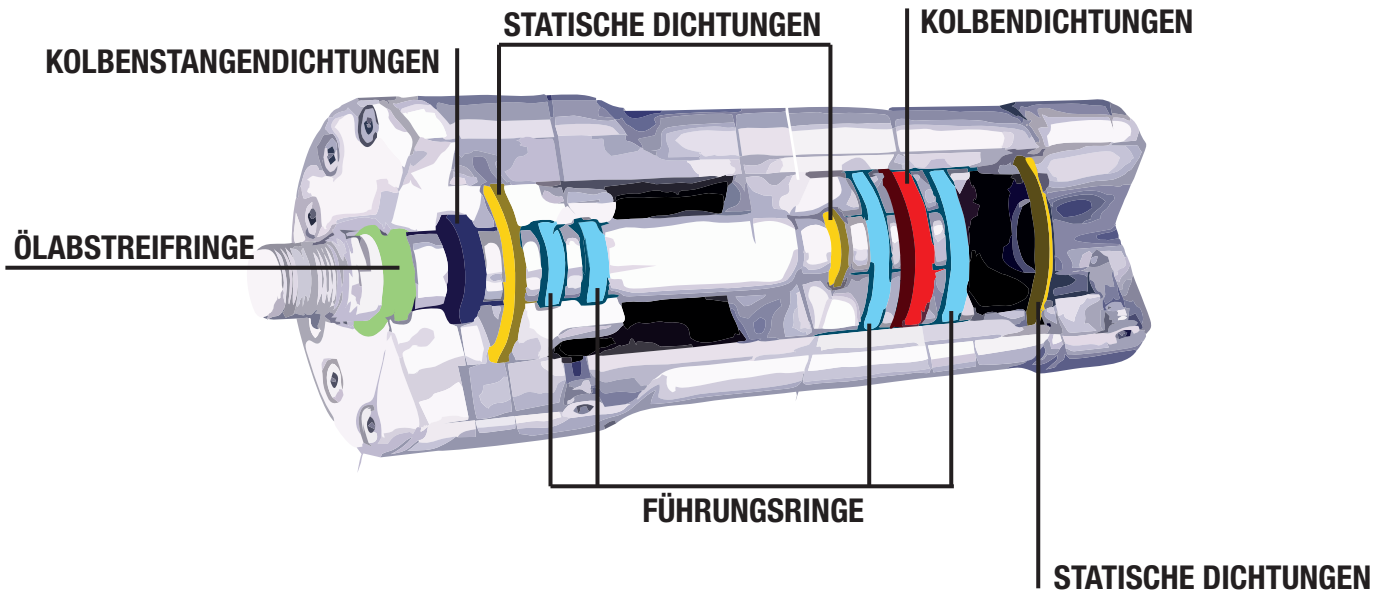



# HYDRAULIKDICHTUNGEN

## ÖLABSTREIFRINGE

Ölabstreifringe sind in Dichtungssystemen von Zylindern eingebaut, um Schmutz, Fremdpartikel, Späne und Feuchtigkeit von den Kolbenstangen abzustreifen, bevor diese in den Zylinder zurückfahren. Dies verhindert eine Verschmutzung der Hydraulikflüssigkeit, die Leitungen, Dichtungen und andere Komponenten beschädigen könnte.

### FAKTOREN ZUR AUSWAHL DER GEOMETRIE VON ÖLABSTREIFRINGE

- lediglich Abstreifer oder Dichtungs-Abstreifer
- Art der Verschmutzung durch den Außenbereich
- maximale Bewegungsgeschwindigkeit (geradlinige oder Rotation)
- Platzbedarf im Konstruktionsraum
- offener oder geschlossener Konstruktionsraum
- min./max. Temperaturbereich
- genaue Daten über das Medium (wichtig für die Materialauswahl)

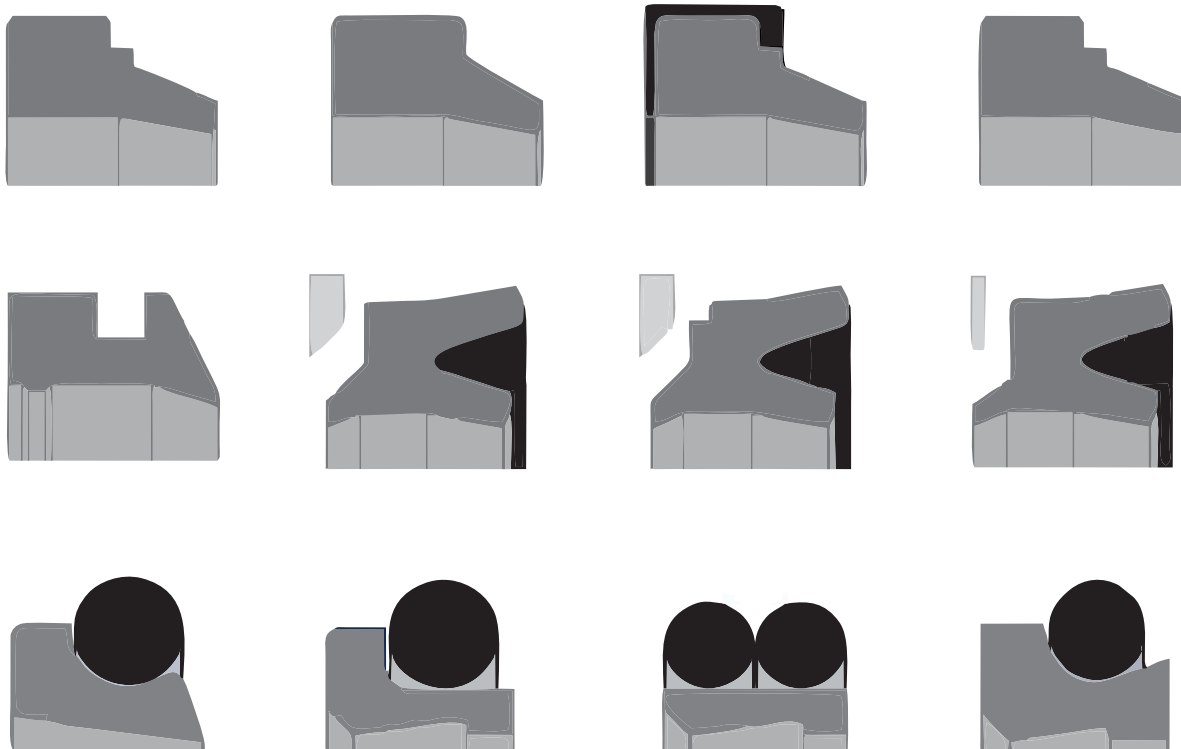

**WIR BIETEN IHNEN SONDERANFERTIGUNGEN VON ÖLABSTREIFRINGEN. BITTE KONTAKTIEREN SIE UNS FÜR WEITERE INFORMATIONEN.**

# HYDRAULIKDICHTUNGEN

## KOLBENSTANGENDICHTUNGEN



Die Kolbenstangendichtung sorgt für die Dichtheit des Systems. Zu dem Haupt-Dichtungseffekt kommt es an der dynamischen Innenseite dieser Dichtung. Damit ist die Kolbenstange abgedichtet und ermöglicht so das Aufpumpen beim Zurückfahren des hydraulischen oder pneumatischen Zylinders. Ohne Abdichtung der Kolbenstange funktioniert kein doppelwirkendes hydraulisches oder pneumatisches System (außer Systeme mit abgedichteten Abziehern).

### FAKTOREN ZUR AUSWAHL VON KOLBENSTANGENDICHTUNGEN

- Platzbedarf im Konstruktionsraum
- Anwendungsbereich des Systems
- maximale Vorschubgeschwindigkeit
- genaue Daten über Maße der Extrusionsfuge
- maximale Druckbelastung
- offener oder geschlossener Konstruktionsraum
- min./max. Temperaturbereich
- genaue Daten über das Medium (wichtig für die Materialauswahl)

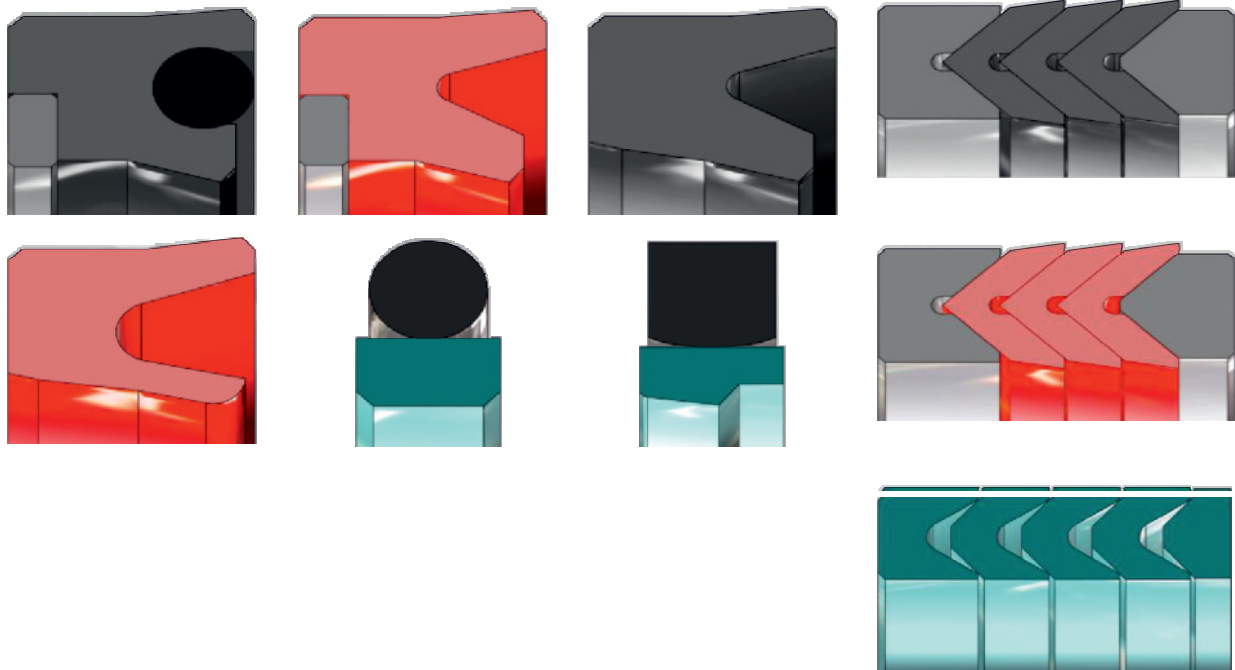

**WIR BIETEN IHNEN SONDERANFERTIGUNGEN VON KOLBENSTANGENDICHTUNGEN. BITTE KONTAKTIEREN SIE UNS FÜR WEITERE INFORMATIONEN.**

# HYDRAULIKDICHTUNGEN FÜHRUNGSRINGEN

Führungsringe sorgen für die Gleichachsigkeit der Kolbenstange im Zylinder.  
Als Führungselemente sind sie sehr wichtige Konstruktionsteile eines komplexem Dichtungssystems.

Ohne genauer Führung würde sich die Lebensdauer der Stangendichtung, bzw. der Kolben sehr verkürzen.

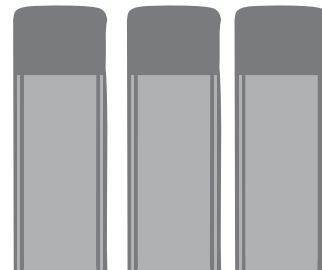
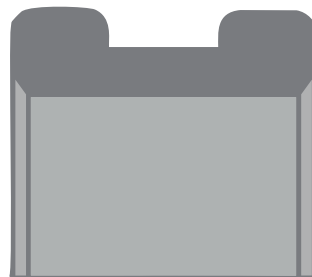
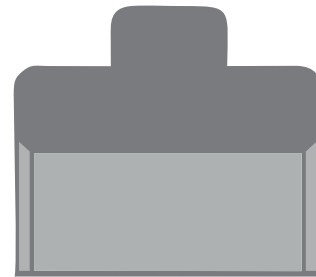
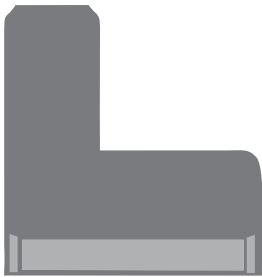

**WIR BIETEN IHNEN SONDERANFERTIGUNGEN VON FÜHRUNGSRINGEN. BITTE KONTAKTIEREN SIE UNS  
BITTE FÜR WEITERE INFORMATIONEN.**

# HYDRAULIKDICHTUNGEN

## KOLBENDICHTUNGEN



Die Kolbendichtung sorgt für eine dynamische und statische Abdichtung zwischen Kolben (Außendurchmesser) und Zylinderrohre.

### FAKTOREN ZUR AUSWAHL VON KOLBENDICHTUNGEN

- einfachwirkendes oder doppelwirkendes Dichtungssystem
- Platzbedarf im Konstruktionsraum
- Anwendungsbereich des Systems
- maximale Druckbelastung
- genaue Daten über Maße der Extrusionsfuge
- maximale Vorschubgeschwindigkeit
- offener oder geschlossener Konstruktionsraum
- min./max. Temperaturbereich
- genaue Daten über das Medium (wichtig für die Materialauswahl)

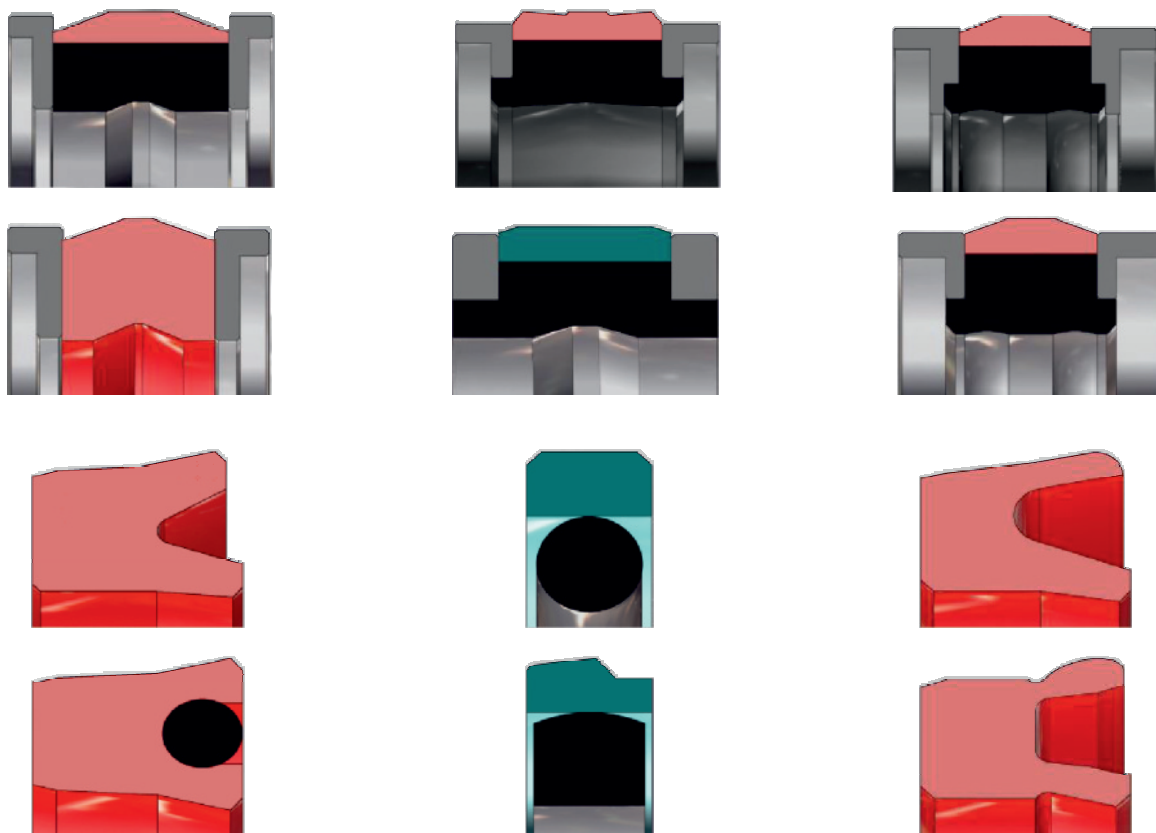

**WIR BIETEN WIR IHNEN SONDERANFERTIGUNGEN VON KOLBENDICHTUNGEN. BITTE KONTAKTIEREN SIE UNS FÜR WEITERE INFORMATIONEN.**

# HYDRAULIKDICHTUNGEN

## STATISCHE DICHTUNGEN

Statische Dichtungen werden meistens für statische Abdichtungen, z.B. an der Innenseite von Kolben oder bei Schraubverbindungen zwischen Zylinder und Rohre verwendet.

Durch das Angebot an verschiedenen Geometrien, steht den Konstrukteuren in diesem Fachgebiet eine breite Auswahl, die sich nach den Anforderungen der gegebenen Anwendung richtet, zur Verfügung.

Die Auswahl der Geometrie von statischen Dichtungen ergibt sich überwiegend nach Konstruktion des Systems.

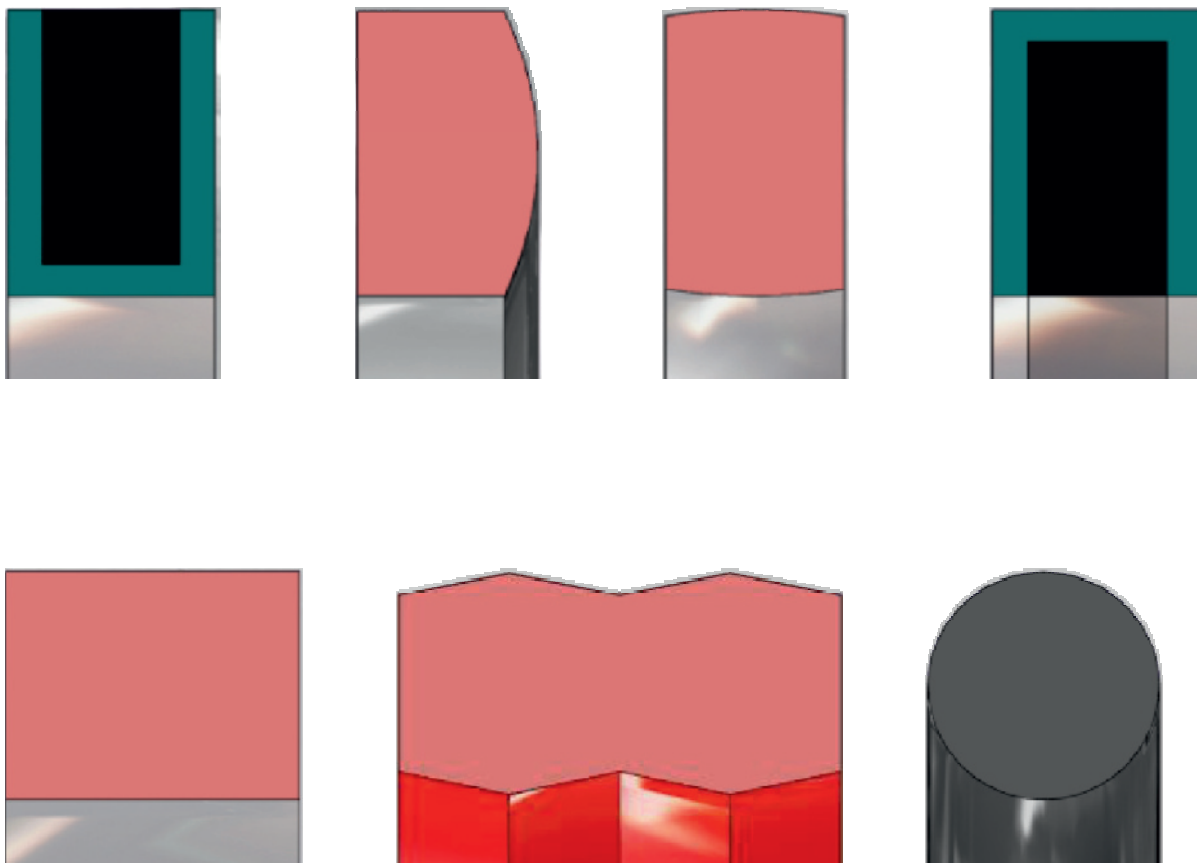

**WIR BIETEN IHNEN SONDERANFERTIGUNGEN VON STATISCHEN DICHTUNGEN. BITTE KONTAKTIEREN SIE UNS FÜR WEITERE INFORMATIONEN.**

# HYDRAULIKDICHTUNGEN

## WELLENDICHTUNGEN



Die Wellendichtung hat die Aufgabe, dass die rotierende Welle, die an der Innenseite vom Ölbad belastet wird, nach außen abgedichtet wird. Auf dem ersten Blick scheint das einfach, jedoch stellt man nach Erwägung aller Betriebsbedingungen fest, dass es die komplizierteste ist.

### FAKTOREN ZUR AUSWAHL VON WELLENDICHTUNGEN

- der Beschmutzungsgrad vom Außengebiet
- Platzbedarf
- Offener oder geschlossener Konstruktionsraum
- maximale Umdrehungen pro Minute für die Berechnung der Umfangsgeschwindigkeit
- Betriebsdruck oder drucklose Verwendung
- Material, Rauheit und Härte der Wellenoberfläche
- min./max. Temperaturbelastung
- genaue Daten über das Medium (wichtig für die Materialauswahl)

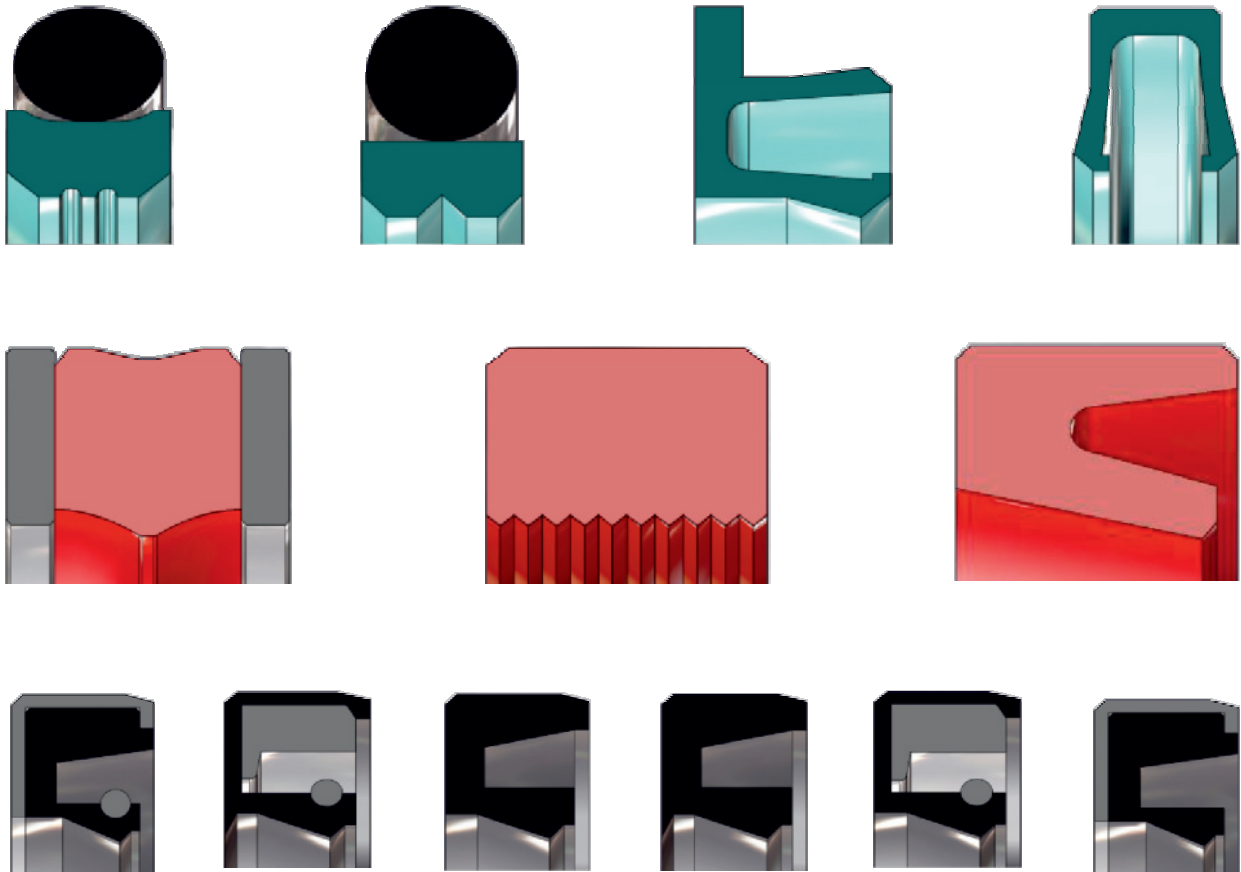

# HYDRAULIKDICHTUNGEN

## STÜTZRINGEN

Stützringe werden überwiegend für das Minimieren der Extrusionsfuge benutzt, die durch die Produktion oder dem Verschleiß von Metallteilen entsteht.

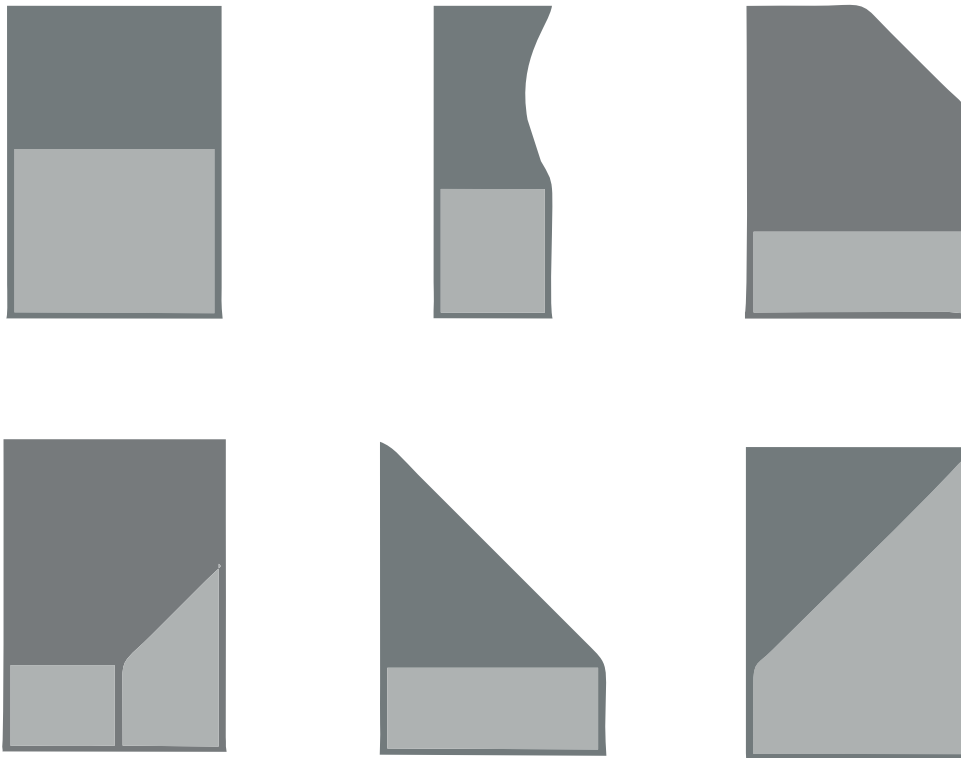

## WASSER-DICHTUNGSRINGE

MATERIAL: **ADISEAL** ((asbestfreie Dichtungsringe)

NUTZUNG: Wasser, Gase, Öle, Alkohole, Hauptchemikalien

ZERTIFIZIERUNG: Germanischer Lloyd, KTW, Temp. 140 - 330°C

Wasser-Dichtungsringe		Preis		
Maß	Maß Außen X Innen	ADISEAL BEZABEST st. 1,6 mm / 140 °C	ADISEAL BEZABEST st. 2,0 mm / 140 °C	ADISEAL BEZABEST st. 2,0 mm / 330 °C
1/4"	24 x 17 mm	0,83	0,89	2,20
3/8"	27 x 19 mm	0,96	1,04	2,40
1/2"	34 x 24 mm	1,25	1,42	2,99
3/4"	38 x 27 mm	1,45	1,62	3,70
1"	44 x 34 mm	1,90	1,90	4,95
5/4"	56 x 44 mm	2,69	2,65	6,30
6/4"	62 x 47 mm	3,15	3,30	6,95
2"	78 x 60 mm	4,05	4,40	10,10
2 1/2"	96 x 75 mm	6,20	6,80	14,85
3"	110 x 85 mm	7,80	8,50	16,95

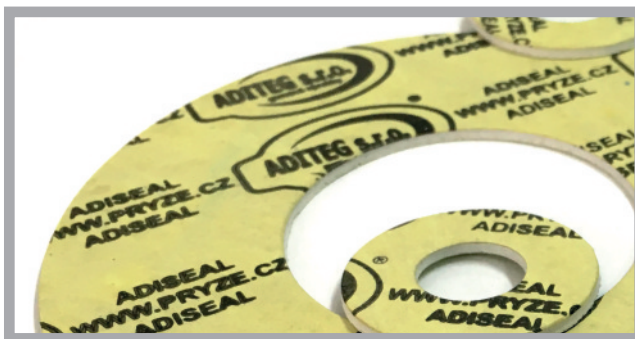



## WASSER-DICHTUNGSRINGE

MATERIAL:

**SBR** - 65 +/-5 Sh, schwarz, 2-3 Mpa  
 - Temperatur -30°C až +80°C

**SBR - FDA** - Temperatur 65 +/- Sh. A, hell, 5 Mpa  
 - Temperatur -30°C až +80°C  
 - Nahrungsmittelplatte - FDA

Nahrungsmittelplatten bestehen aus Rohstoffen, die gemäß der seit 1. April 1998 überarbeiteten FDA-Norm, Akt. 21, Teil 170-199, zugelassen sind.

Wasser-Dichtungsringe		Preis		
Maß	Maß Außen X Innen	GUMMI / SBR St. 2 mm <sup>2</sup> 2 - 3 MPa - do 80 °C	GUMMI / SBR St. 3 mm <sup>2</sup> 2 - 3 MPa - do 80 °C	GUMMI - Nahrungsmittel St. 2 mm 5 MPa - do 80 °C
1/4"	24 x 17 mm	0,61	0,65	0,87
3/8"	27 x 19 mm	0,69	0,74	0,98
1/2"	34 x 24 mm	0,89	0,96	1,32
3/4"	38 x 27 mm	0,97	1,06	1,52
1"	44 x 34 mm	1,10	1,20	1,95
5/4"	56 x 44 mm	1,35	1,50	2,78
6/4"	62 x 47 mm	1,65	1,70	3,21
2"	78 x 60 mm	1,99	2,40	4,59
2 1/2"	96 x 75 mm	2,40	3,20	6,40
3"	110 x 85 mm	2,85	4,35	7,99



Wir stellen gewünschte Dichtungen und Stanzprodukte aus verschiedenen Materialien her:

- geläufige Gummiarten
- selbstklebender Gummi
- plastische- und Isolationsstoffe
- Materialien für Hochdruckanwendungen
- Folien

Auf Wunsch unserer KlientInnen liefern wir auch Dichtungen aus weiteren Materialien.

Wir bieten gestanzte Ringe mit sowie ohne Löchern, Dichtungen nach Zeichnung oder Muster, Streifen, Unterlagen, Zuschnitte und sonstige Dichtungen. Die maximale Größe und Stärke der Dichtungen richten sich nach der Verfügbarkeit der verwendeten Materialien.



# GEPRESSTE PRODUKTE

Der größte Anteil dieser Produkte wird in der Autoindustrie und im Maschinenbau benutzt.

In diese Gruppe gehören überwiegend:

O-Ringe, Membranen, Stopfbuchsen, Manschetten, Anschläge, Gummiprodukte, gummierte oder kombinierte mit Metall.

Die benutzten Materialien reichen von den geläufigsten wie NR oder SBR über EPDM, NBR, CR bis zu Silikon und Fluormangan in Härten von 30-90°C.

Diese breite Palette an Kautschukmischungen ermöglicht es uns, alle Anforderungen an Gummiprodukte zu erfüllen, wie Beständigkeit gegen Öle, Ozon, Temperatur, Druck, Abrieb, Chemikalien, usw.

Die Auswahl der Materialien ist nach den mechanischen und chemischen Bedingungen der Arbeitsumgebung möglich.



# O - RINGEN



*...dichtet sofort*

**O-Ringe** sind ringförmige Dichtungselemente, die durch ihre Dichtungseigenschaften den unerwünschten Verlust von Flüssigkeiten oder Gasen verhindern. Die Dichtwirkung ergibt sich durch Zusammenpressen des Ringprofils, welches in der Nut gestützt wird.

**O-Ringe** werden als zerlegbare Stoßstellen für die Dichtung von unbeweglichen Teilen (Deckel, Flanschen, Nippel), sowie beweglichen Teilen in der Hydraulik- und Pneumatik (Kolben, Kolbenstangen) verwendet.

**O-Ringe** sind vielseitig einsetzbar, da sie einfach sind, beidseitig abdichten, keinen großen Bauraum benötigen und einfach zu montieren sind. Für die Produktion verwenden wir geläufige Wertstoffe, sowie Materialien auf Wunsch unserer KlientInnen. Es gibt hunderte von Produkten aus verschiedenen Wertstoffen und Maßen. Ihre Verwendung können Sie mit unseren Mitarbeiterinnen besprechen.

Profile werden aufgrund ihrer mechanischen, physikalischen und chemischen Eigenschaften sowie der dauerhaften Verformung, als Dichtung von Konstruktions- und Bauteilen in verschiedenen Industriebereichen eingesetzt. Sie sind luftdicht und haben praktisch keine Flüssigkeitsaufnahme. In einem dem Material entsprechendem Temperaturbereich sind sie witterungsbeständig, ohne Änderungen ihrer physikalischen, mechanischen und chemischen Eigenschaften. Wir bieten Profile in den geläufigen Formen, sowie in Sonderformen an.

Je nach Kundenwunsch fertigen wir Profile nach vorgelegten Zeichnungen an.

Die Grundmaterialien der Profile sind Gummis (EPDM, NBR, VITON, CR, SILIKON) und mikroporöse Gummis (CR, EPDM, SILIKON).

Weitere Materialien auf Anfrage.



# SILIKONPROFILE - QUADRATISCH / RECHTECKIG

Rohgewicht:	1,1 - 1,24g/cm <sup>3</sup>
UV-Ozon / Alterung	ausgezeichnet
Shore A:	60 +/- 5
Farbe:	weiß
Temperatur	-60 °C, +200 °C
Kurzzeitige Temperatur:	+230 °C
Zerreiße-Dehnung	> 350%
Zugfestigkeit DIN 53504	> 7 MPa

Silikonprofile quadratisch / rechteckig - 60 +/- 5Sh., weiß

Maß		Preis				
mm	mm	1,0 - 9,9 lm	10,0 - 24,9 lm	25,0 - 49,9 lm	50,0 - 99,9 lm	od 100,0 lm
3	6	13,80	11,80	10,30	8,30	6,90
3	10	22,90	19,70	17,20	13,80	11,50
3	20	45,90	39,30	34,40	27,50	22,90
3	25	57,40	49,20	43,00	34,40	28,70
4	6	18,40	15,70	13,80	11,00	9,20
4	8	24,50	21,00	18,40	14,70	12,20
5	5	19,10	16,40	14,30	11,50	9,60
5	10	38,20	32,80	28,70	22,90	19,10
5	15	57,40	49,20	43,00	34,40	28,70
5	20	76,50	65,50	57,40	45,90	38,20
5	25	95,60	81,90	71,70	57,40	47,80
6	6	27,20	23,60	20,60	16,50	13,80
6	8	36,70	31,50	27,50	22,00	18,40
6	10	45,0	39,30	34,40	27,50	22,90
6	15	68,80	59,00	51,60	41,30	34,40
8	8	48,90	41,90	36,70	29,40	24,50
8	11	67,30	57,70	50,50	40,40	33,60
8	15	91,80	78,70	68,80	55,10	45,90
8	20	122,40	104,90	91,80	73,40	61,20
10	10	76,50	65,50	57,40	45,90	38,20
10	12	91,80	78,70	68,80	55,10	45,90
10	15	114,70	98,30	86,00	68,80	57,40
10	20	152,90	131,10	114,70	91,80	76,50
10	30	229,40	196,60	172,10	137,60	114,70
12	12	11,10	94,40	82,60	66,10	55,10
12	20	183,50	157,30	137,60	110,10	91,80
14	14	149,90	128,50	112,40	89,90	74,90
15	15	172,10	147,50	129,00	103,20	86,00
15	20	229,40	196,60	172,10	137,60	114,70
15	25	286,80	245,80	215,10	172,10	143,40
15	30	344,10	295,00	258,10	206,50	172,10
20	20	305,90	262,20	229,40	183,50	152,90
20	30	458,80	393,30	344,10	275,30	229,40
25	25	477,90	409,70	358,50	286,80	239,00
30	30	688,20	589,90	516,20	412,90	344,10

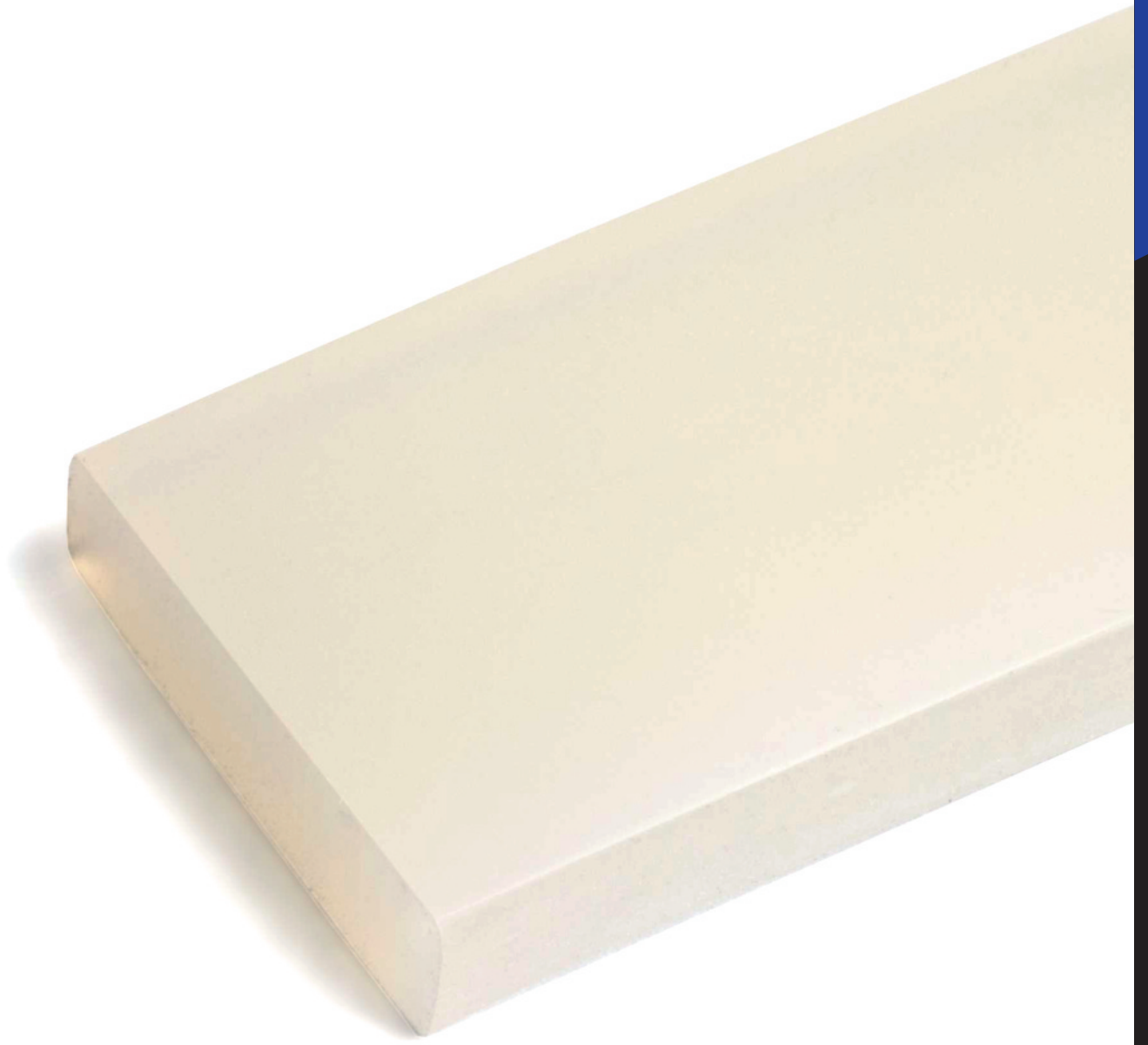

**PROFILE**

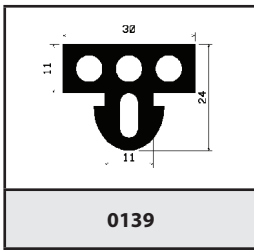

0139

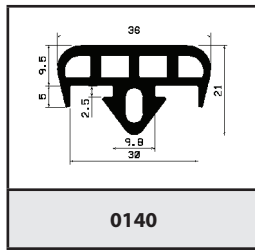

0140

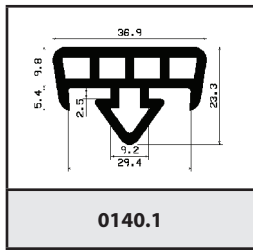

0140.1

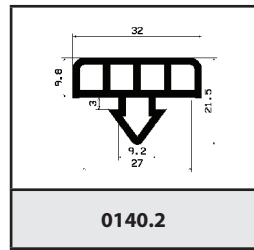

0140.2

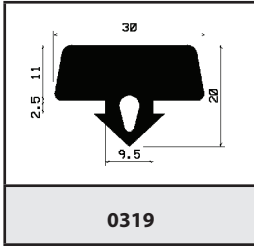

0319

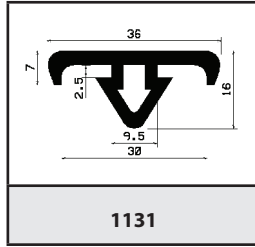

1131

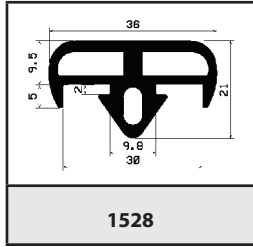

1528

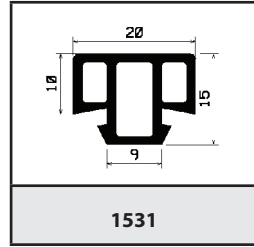

1531

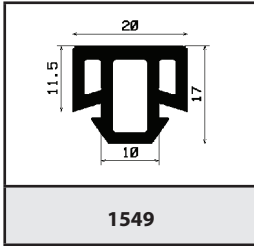

1549

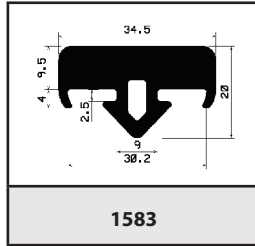

1583

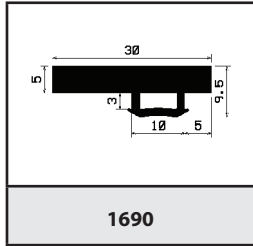

1690

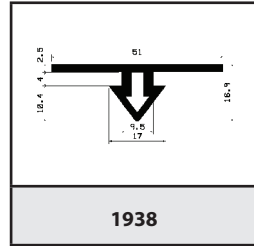

1938

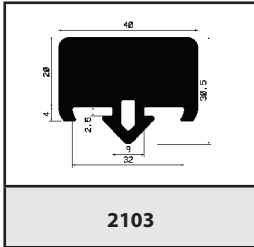

2103

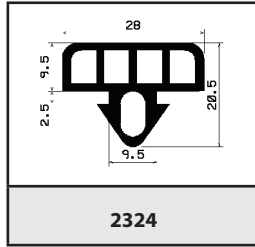

2324

○ Mikroporös-, mikroporös-/silikon-

● gummi-, silikon-



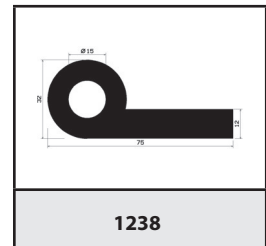
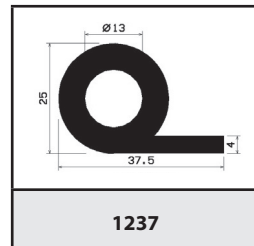
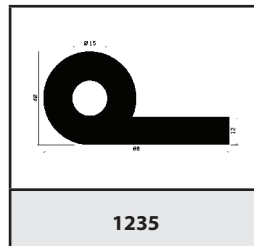
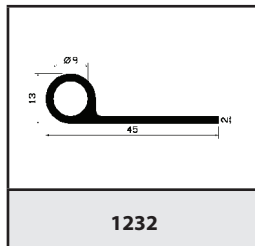
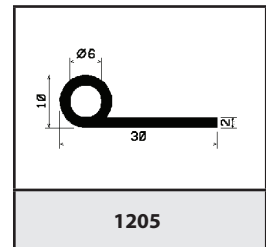
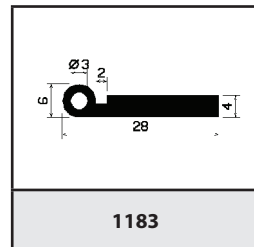
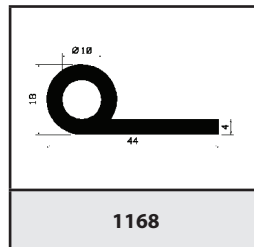
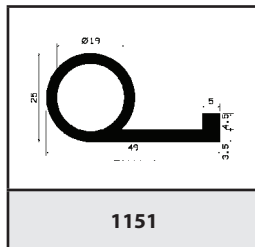
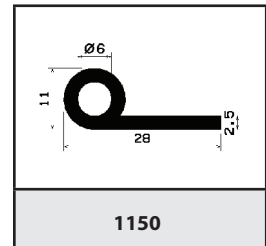
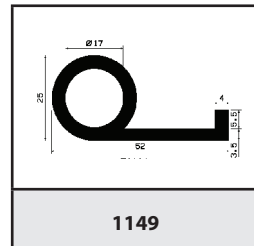
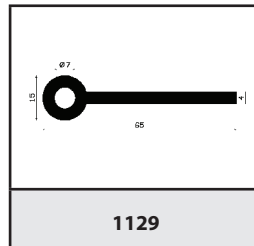
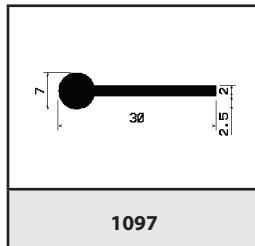
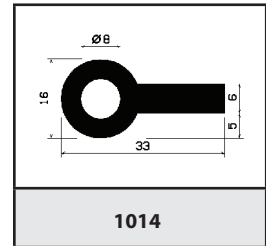
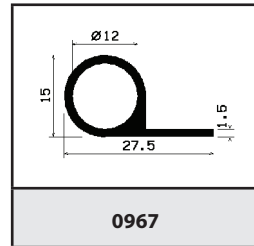
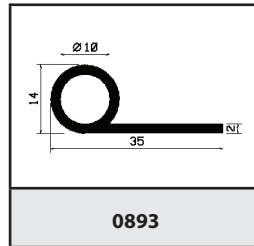
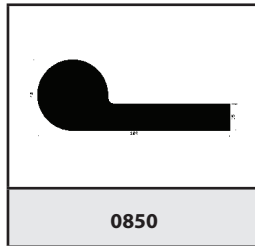
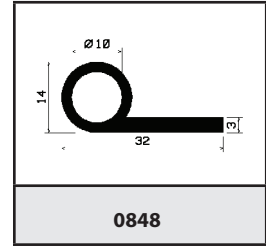
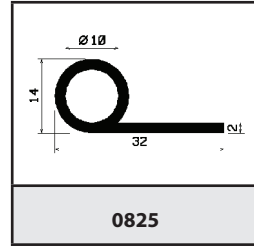
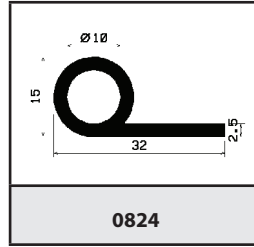
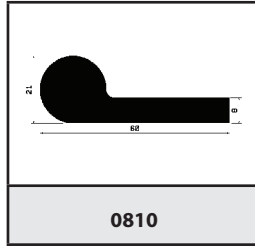
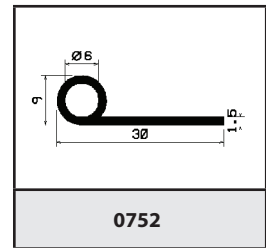
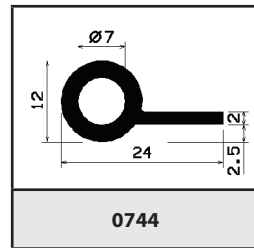
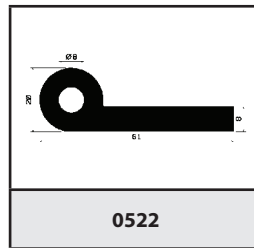
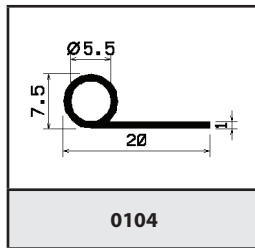

○ Mikroporös-, mikroporös-/silikon-      ● gummi-, silikon-

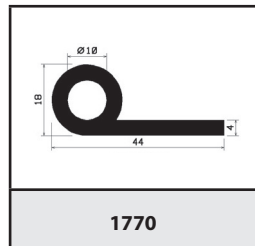
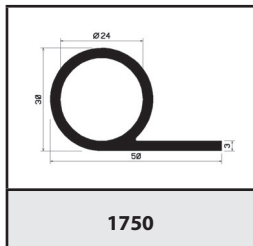
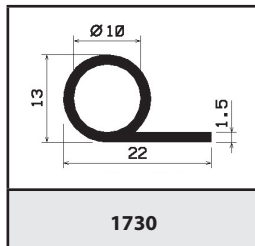
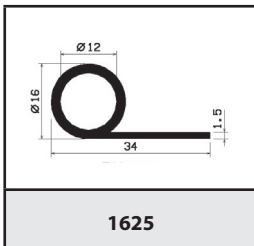
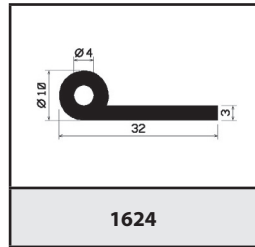
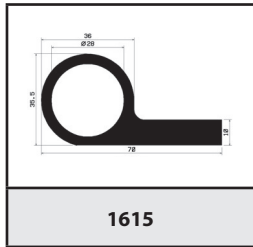
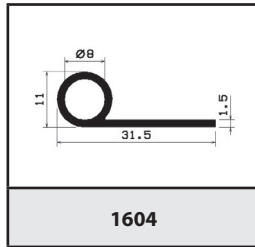
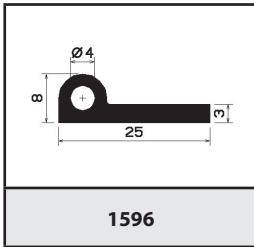
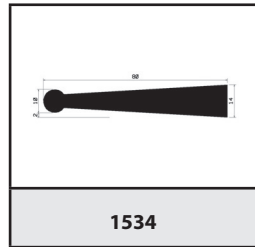
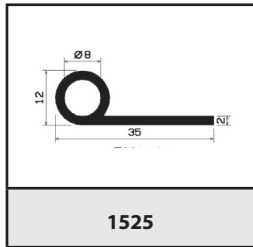
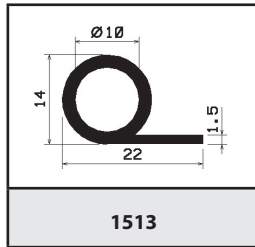
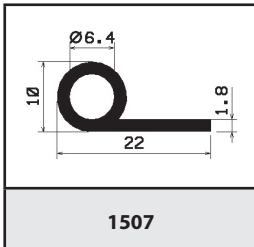
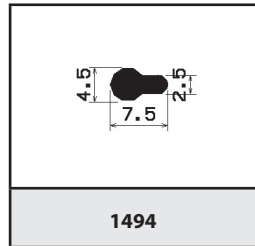
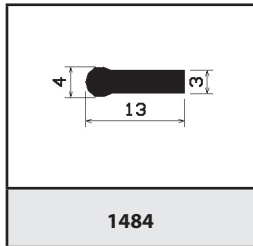
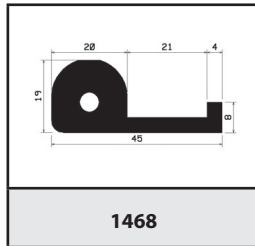
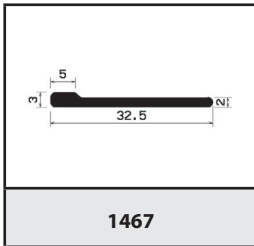
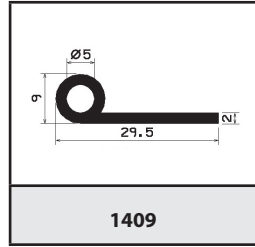
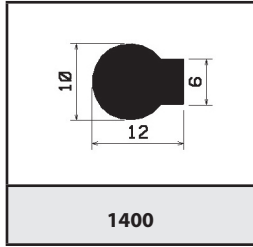
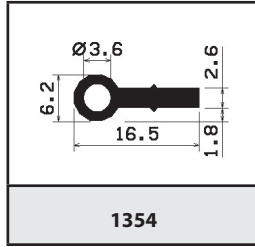
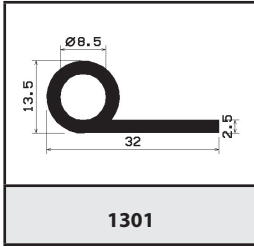
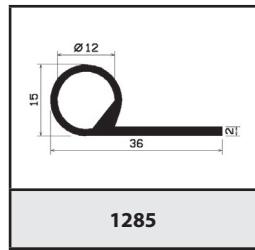
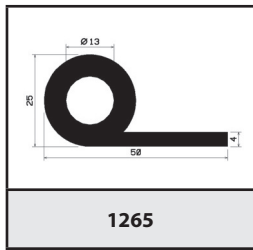
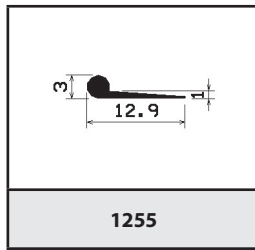
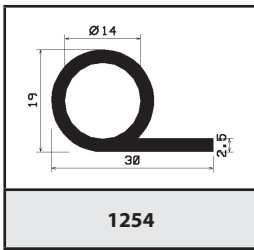

○ Mikroporös-, mikroporös-/silikon-      ● gummi-, silikon-

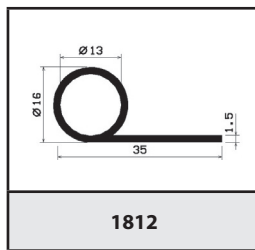

1812

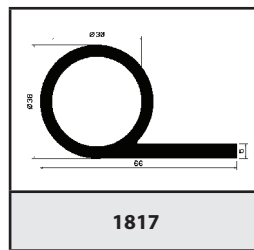

1817

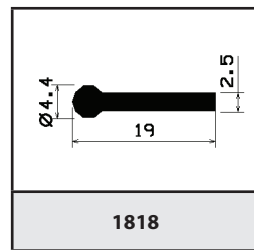

1818

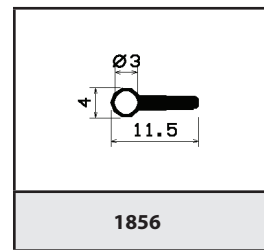

1856

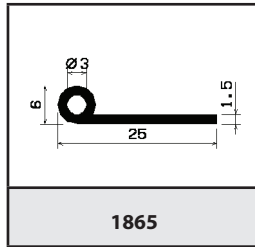

1865

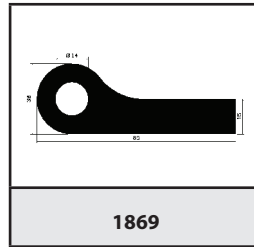

1869

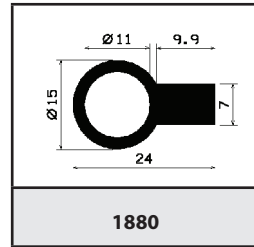

1880

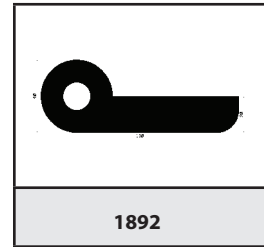

1892

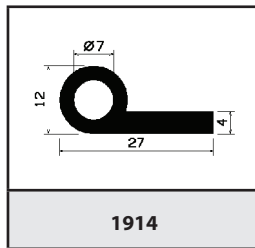

1914

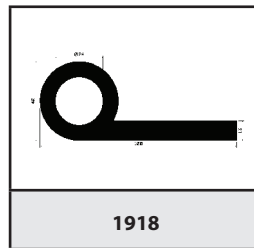

1918

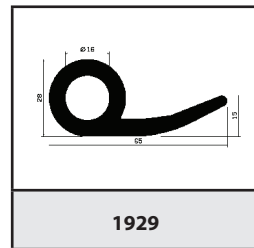

1929

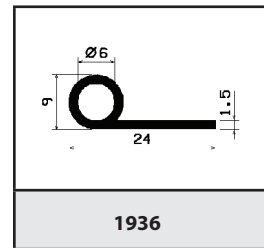

1936

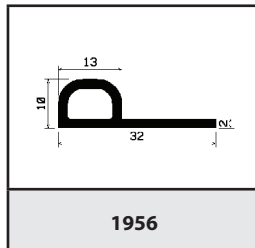

1956

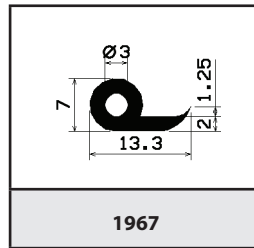

1967

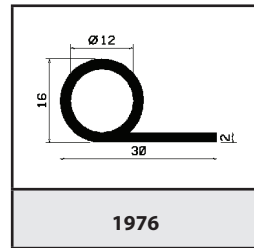

1976

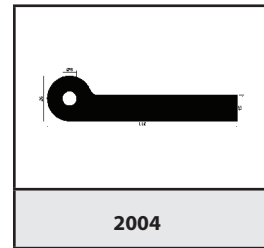

2004

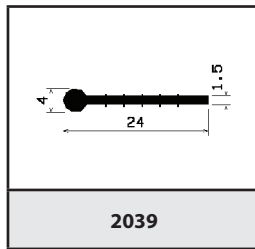

2039

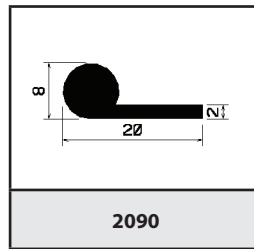

2090

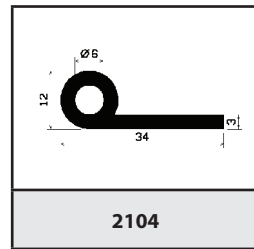

2104

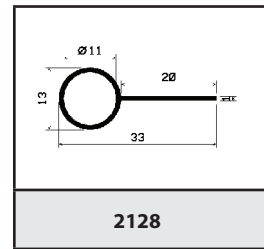

2128

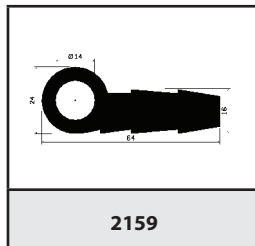

2159

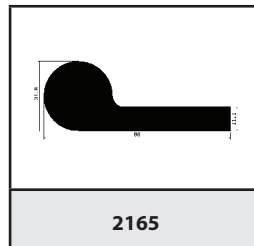

2165

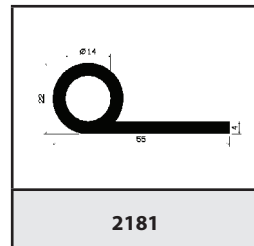

2181

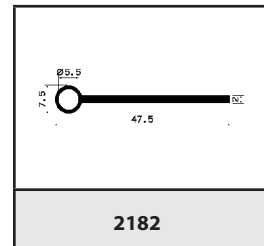

2182

○ Mikroporös-, mikroporös-/silikon-      ● gummi-, silikon-

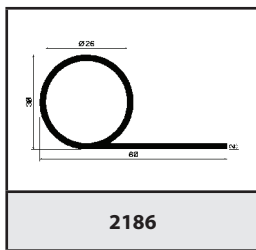

2186

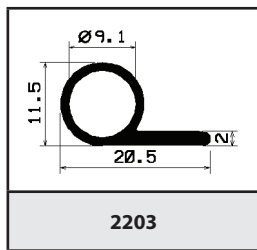

2203

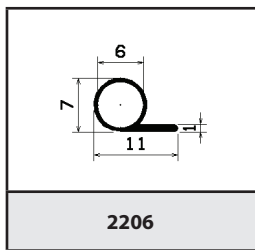

2206

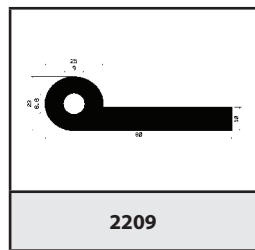

2209

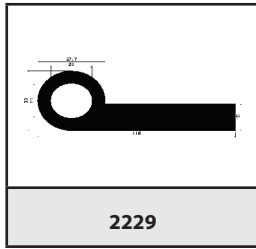

2229

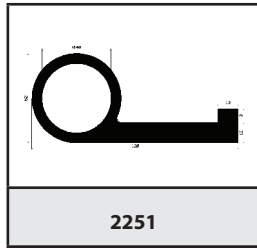

2251

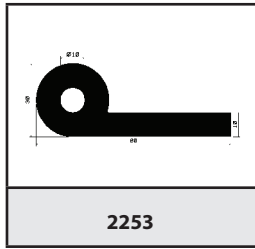

2253

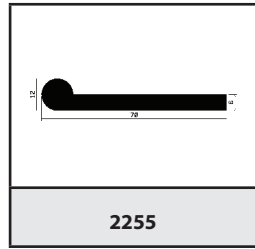

2255

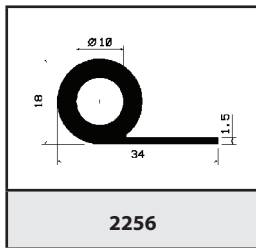

2256

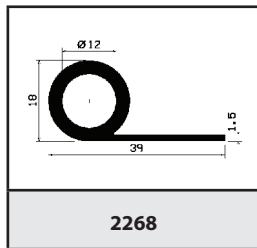

2268

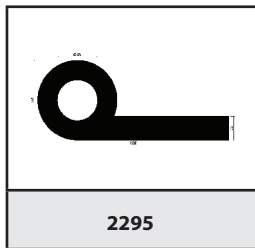

2295

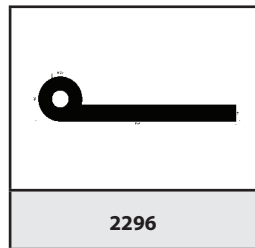

2296

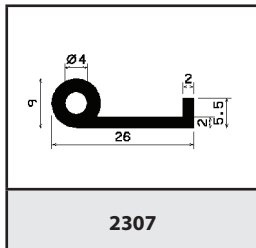

2307

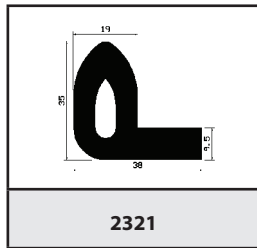

2321

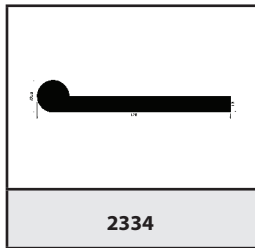

2334

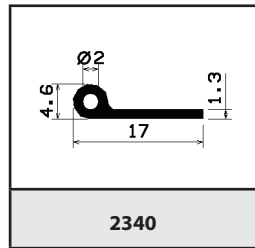

2340

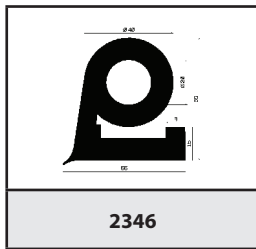

2346

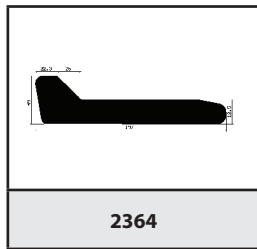

2364

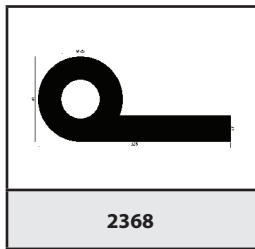

2368

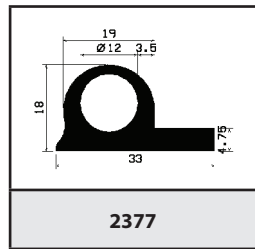

2377

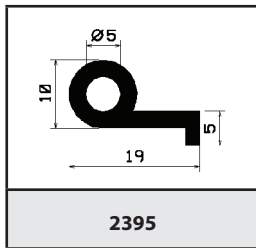

2395

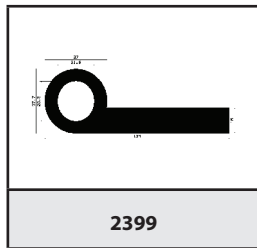

2399

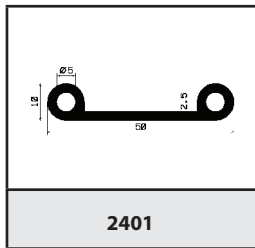

2401

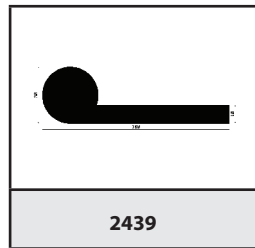

2439

○ Mikroporös-, mikroporös-/silikon-      ● gummi-, silikon-

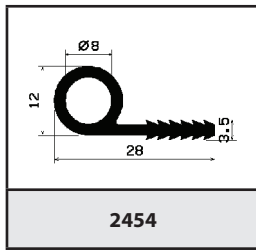

2454

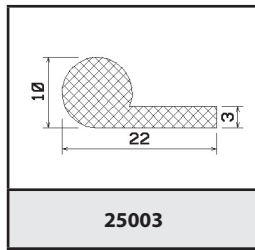

25003

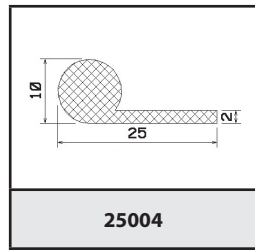

25004

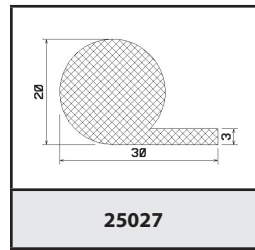

25027

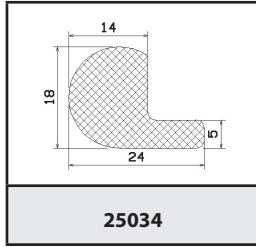

25034

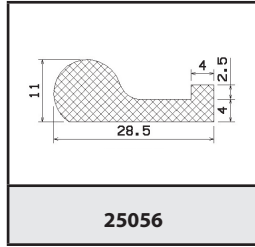

25056

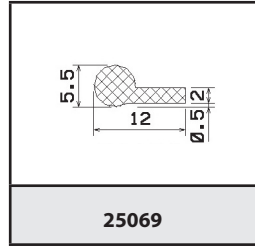

25069

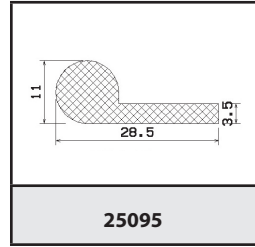

25095

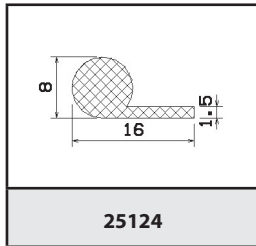

25124

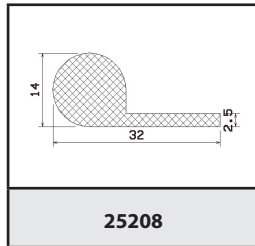

25208

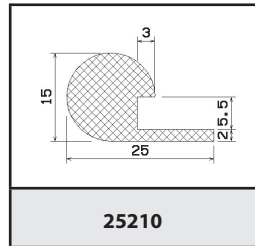

25210

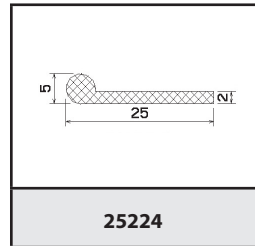

25224

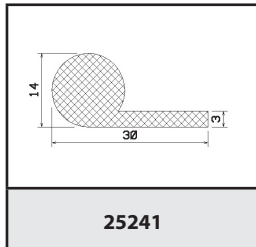

25241

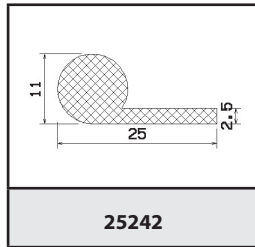

25242

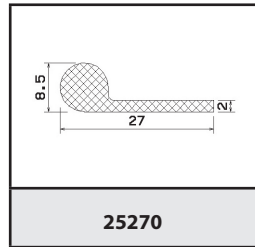

25270

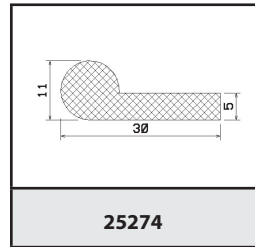

25274

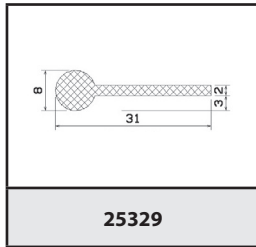

25329

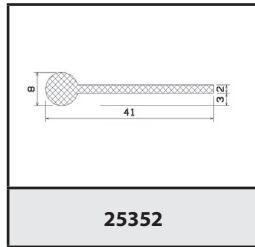

25352

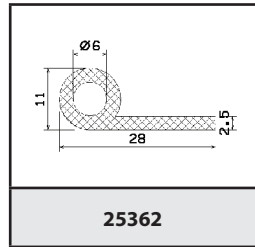

25362

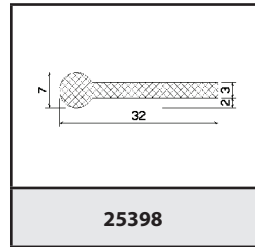

25398

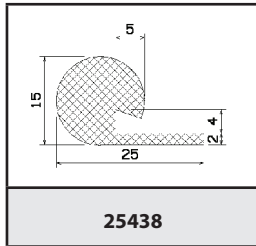

25438

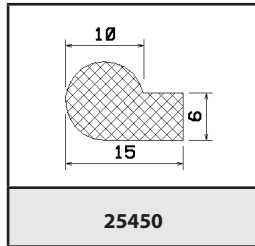

25450

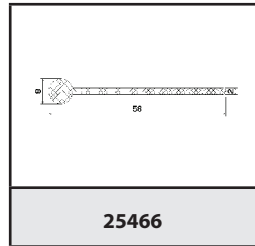

25466

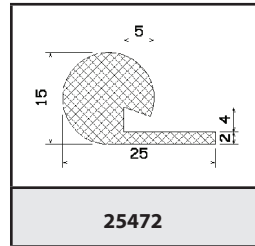

25472

○ Mikroporös-, mikroporös-/silikon-      ● gummi-, silikon-

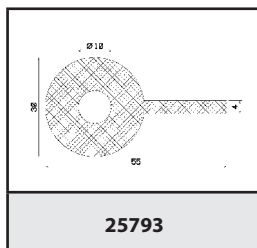
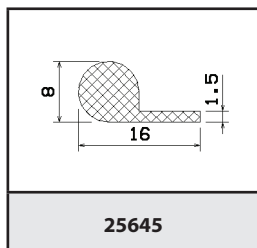
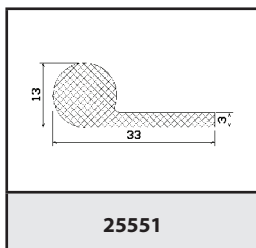
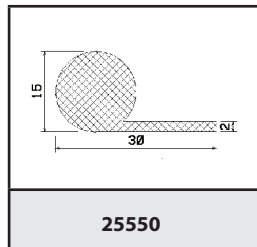
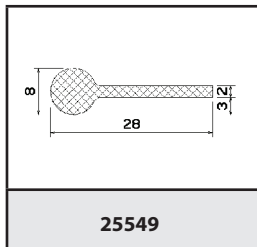
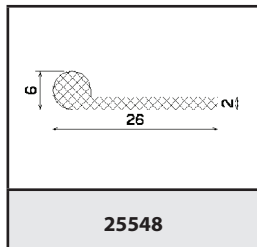
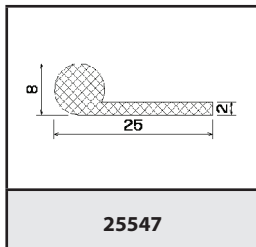
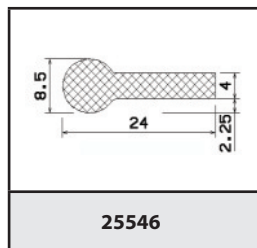
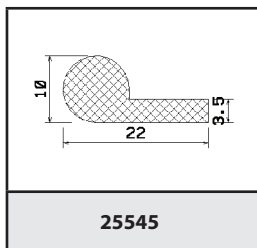
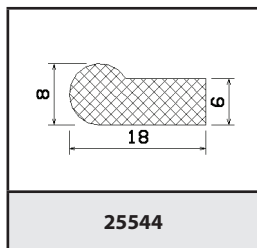
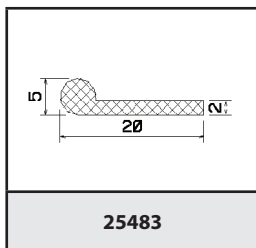

○ Mikroporös-, mikroporös-/silikon-

● gummi-, silikon-

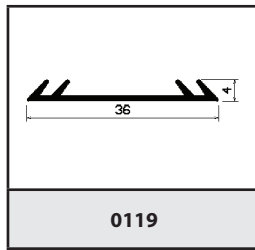

0119

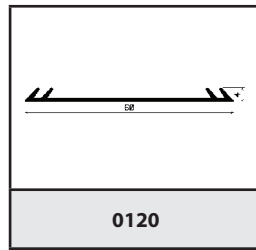

0120

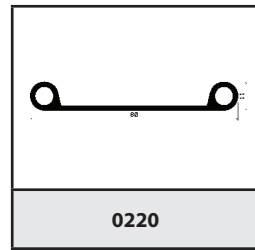

0220

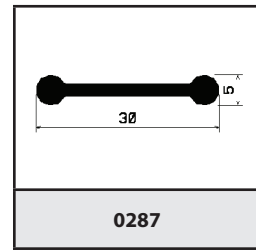

0287

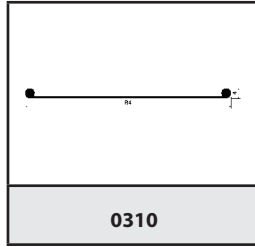

0310

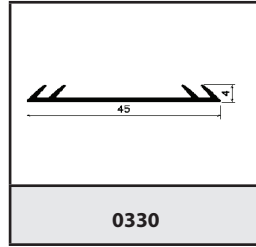

0330

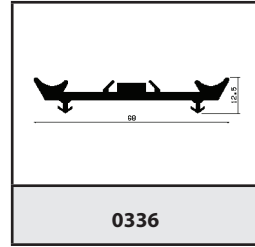

0336

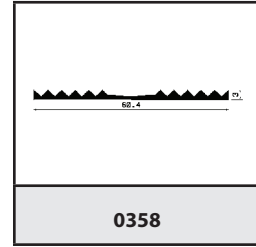

0358

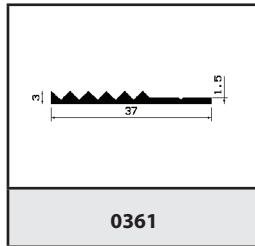

0361

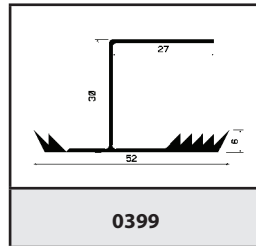

0399

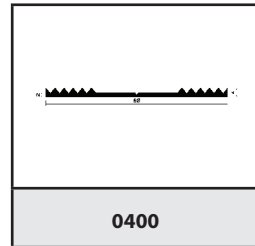

0400

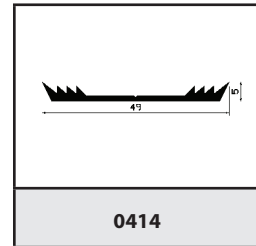

0414

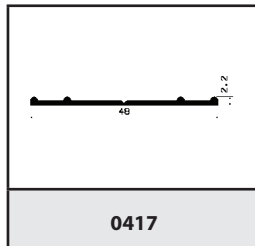

0417

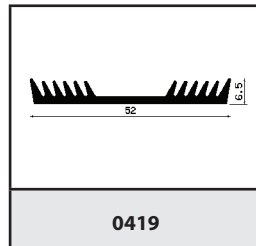

0419

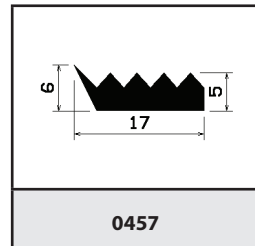

0457

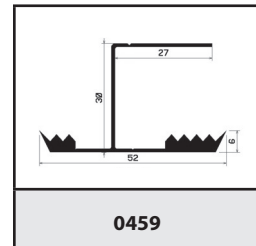

0459

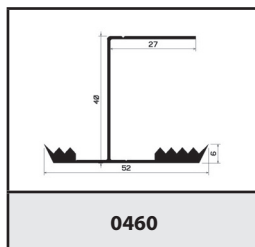

0460

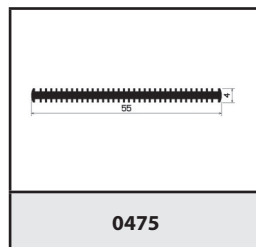

0475

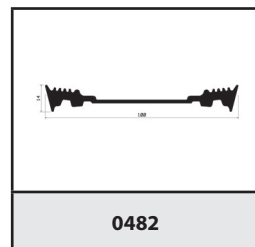

0482

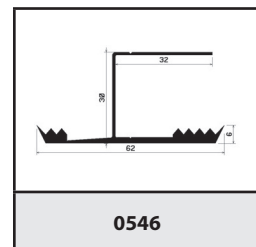

0546

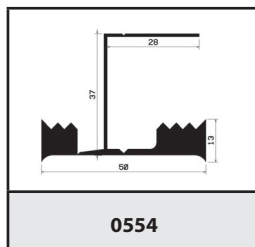

0554

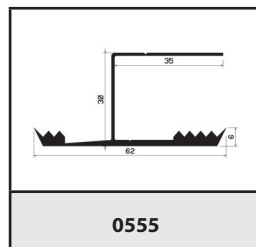

0555

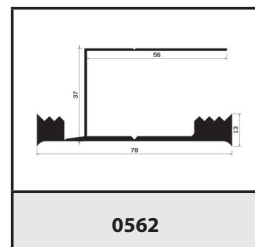

0562

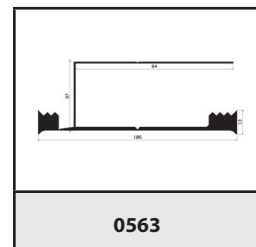

0563

○ Mikroporös-, mikroporös-/silikon-      ● gummi-, silikon-

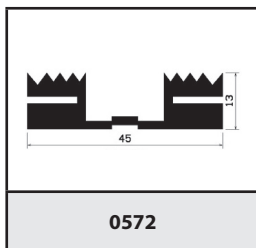

0572

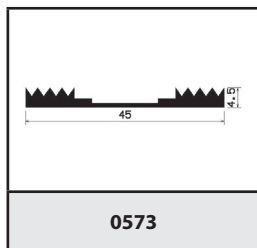

0573

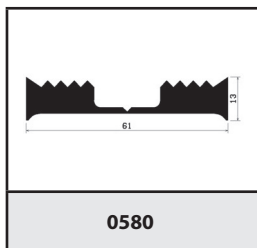

0580

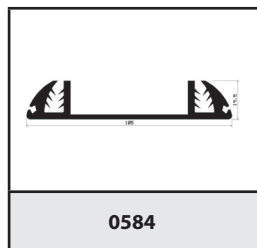

0584

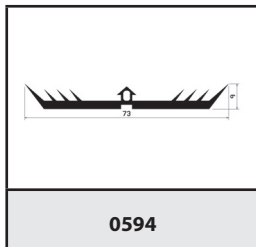

0594

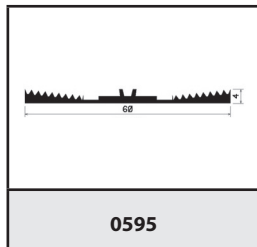

0595

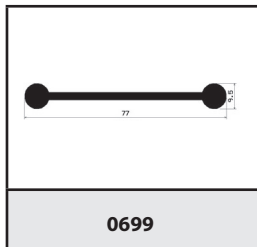

0699

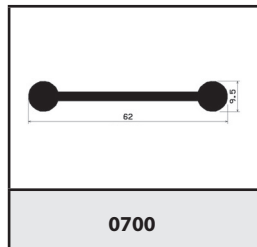

0700

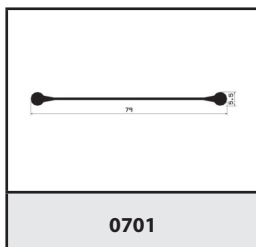

0701

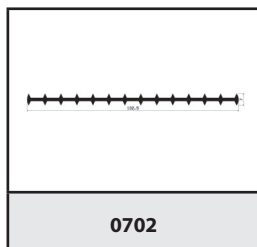

0702

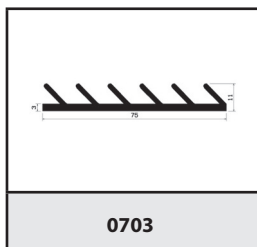

0703

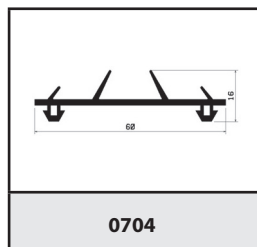

0704

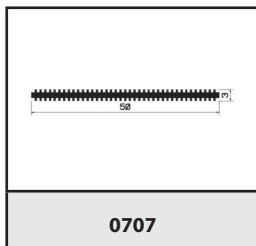

0707

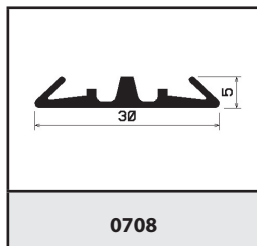

0708

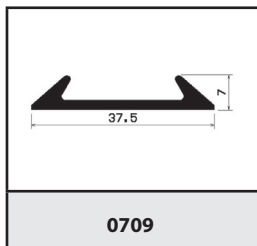

0709

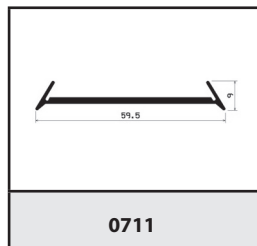

0711

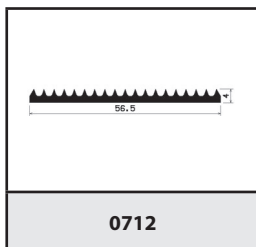

0712

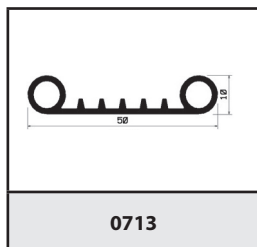

0713

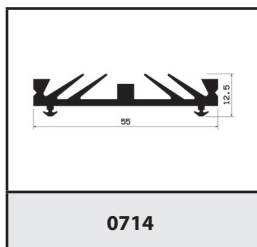

0714

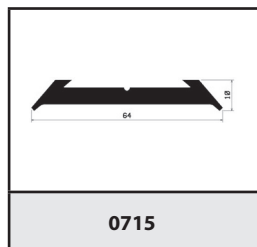

0715

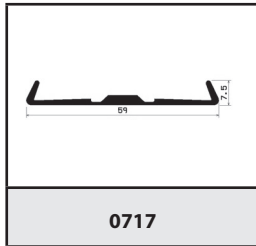

0717

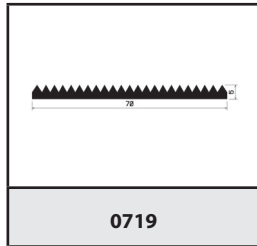

0719

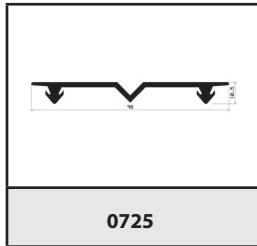

0725

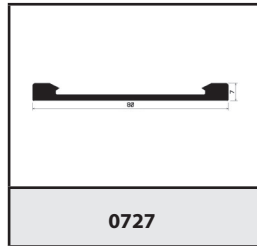

0727

○ Mikroporös-, mikroporös-/silikon-      ● gummi-, silikon-



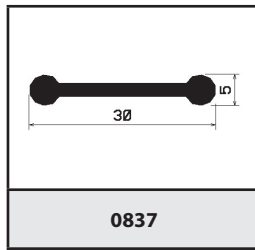

0837

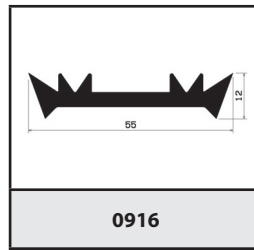

0916

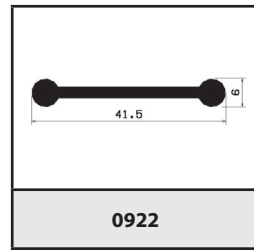

0922

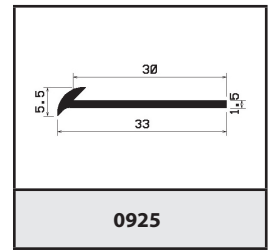

0925

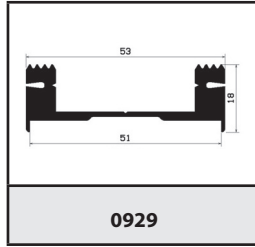

0929

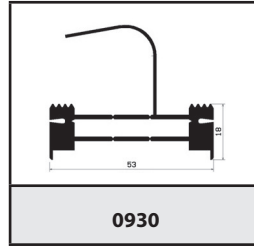

0930

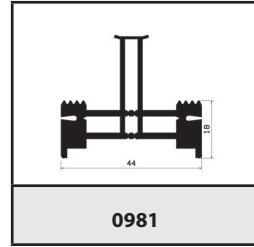

0981

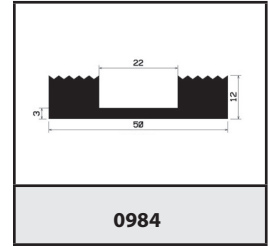

0984

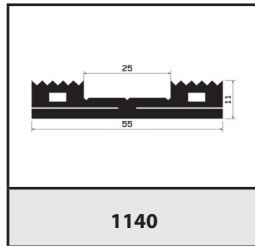

1140

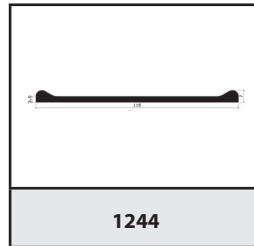

1244

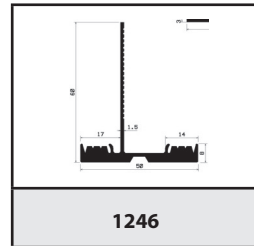

1246

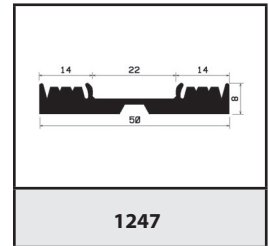

1247

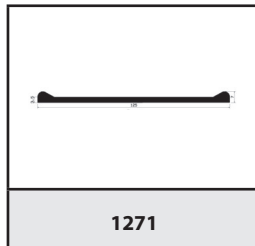

1271

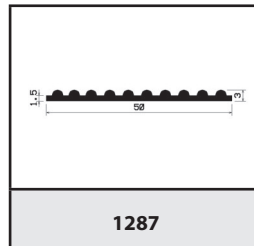

1287

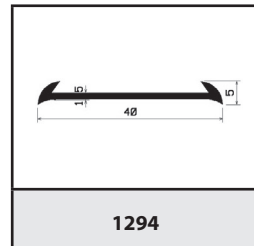

1294

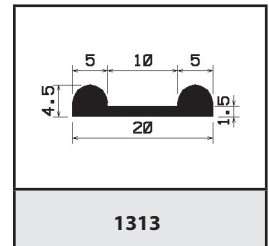

1313

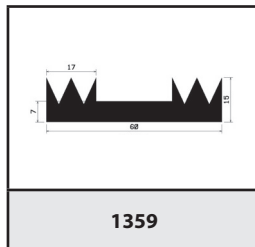

1359

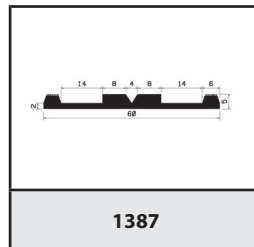

1387

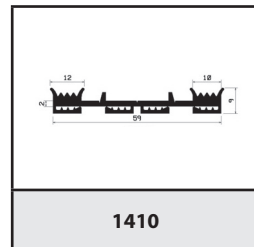

1410

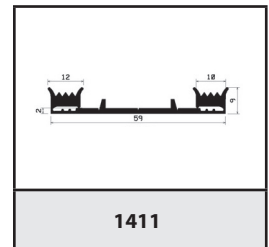

1411

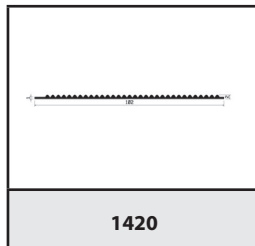

1420

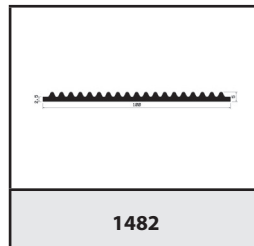

1482

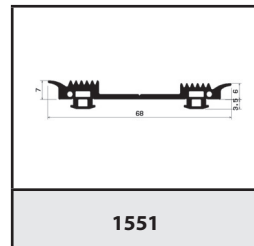

1551

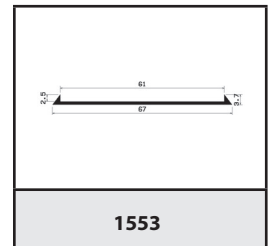

1553

○ Mikroporös-, mikroporös-/silikon- ● gummi-, silikon-

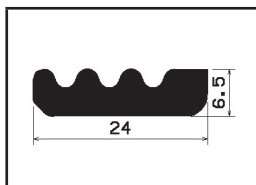

1558

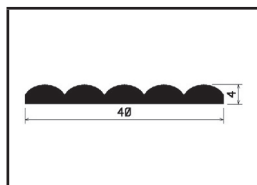

1591

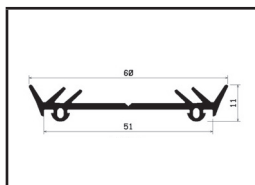

1667

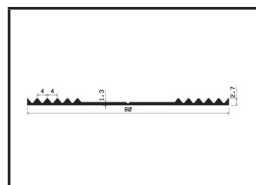

1771

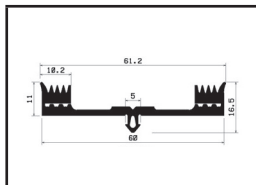

1905

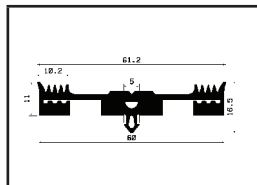

1906

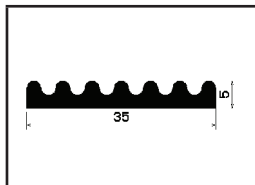

1923

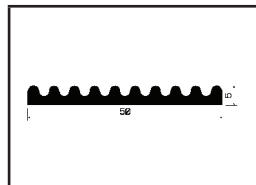

1925

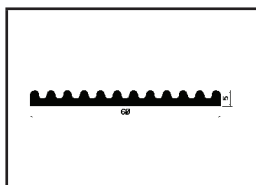

1926

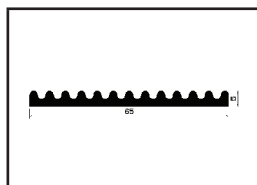

1927

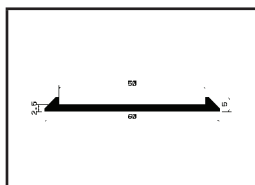

1937

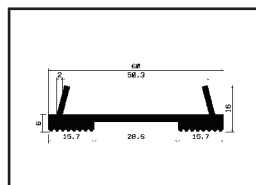

2005

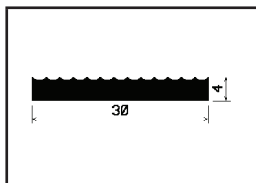

2171

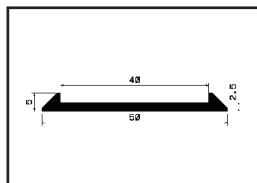

2172

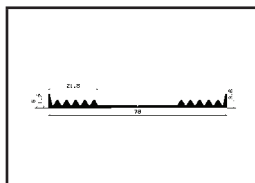

2174

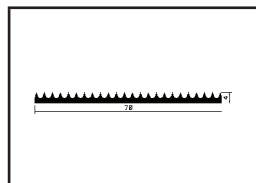

2248

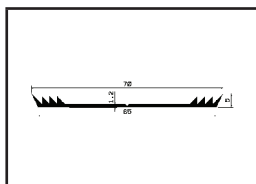

2276

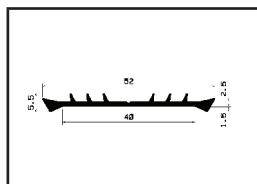

2458

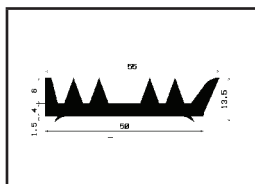

2468

○ Mikroporös-, mikroporös-/silikon-      ● gummi-, silikon-

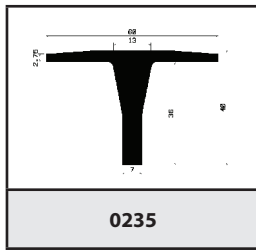

0235

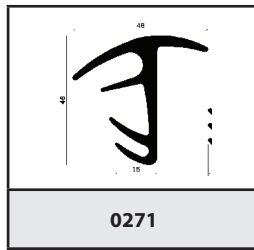

0271

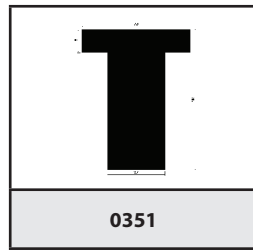

0351

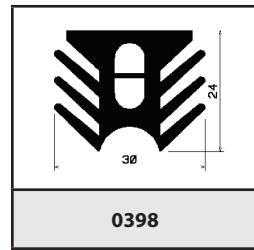

0398

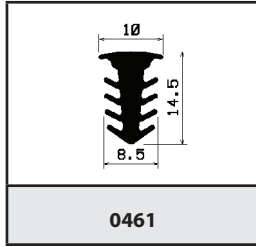

0461

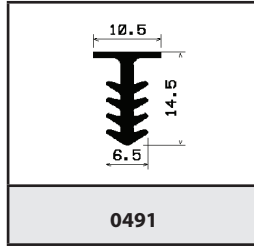

0491

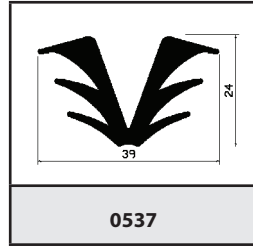

0537

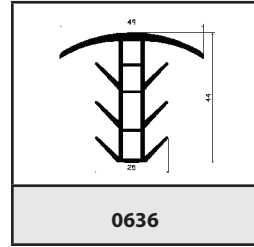

0636

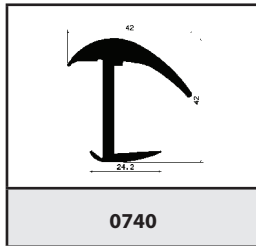

0740

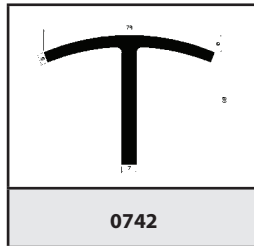

0742

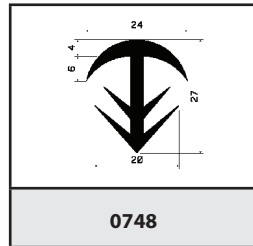

0748

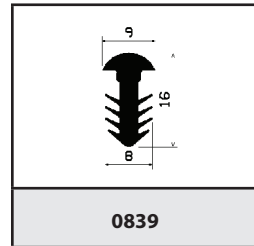

0839

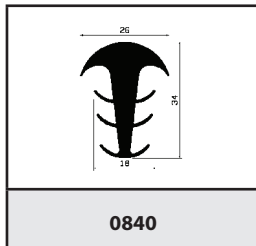

0840

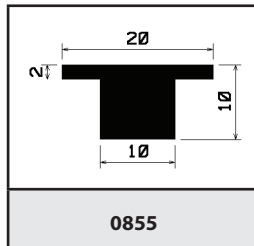

0855

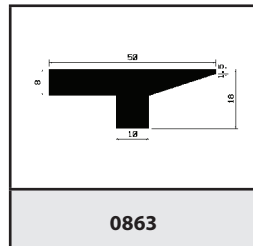

0863

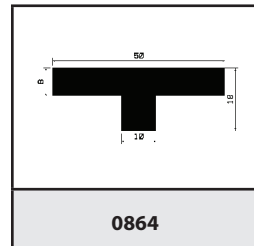

0864

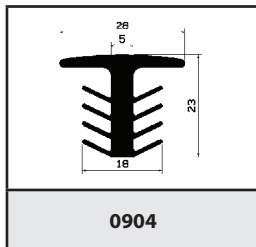

0904

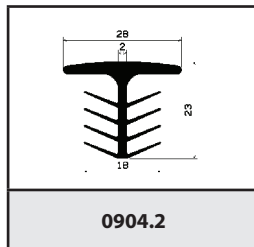

0904.2

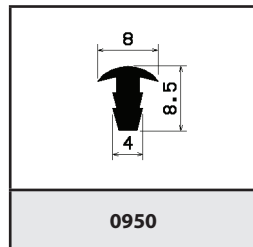

0950

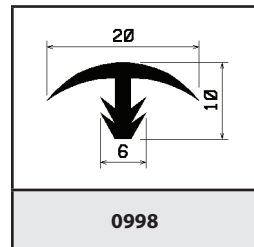

0998

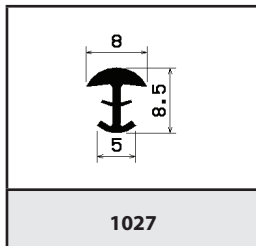

1027

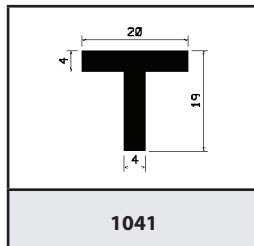

1041

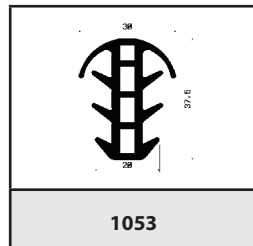

1053

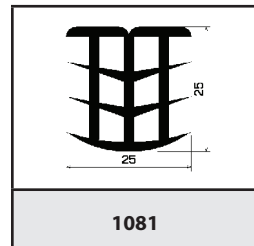

1081

○ Mikroporös-, mikroporös-/silikon- ● gummi-, silikon-

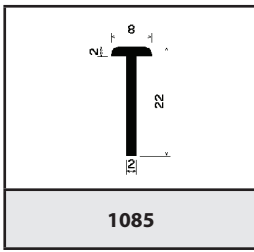

1085

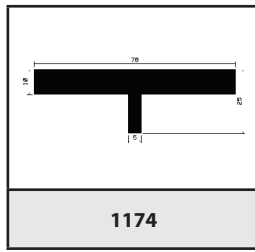

1174

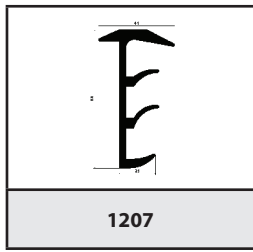

1207

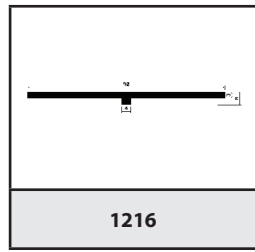

1216

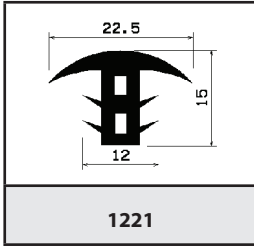

1221

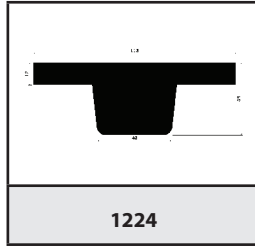

1224

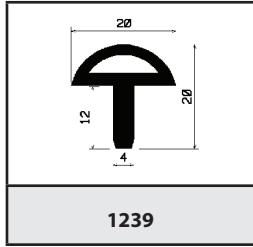

1239

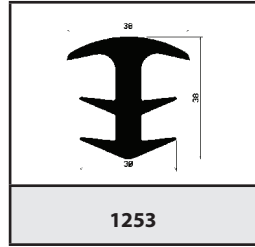

1253

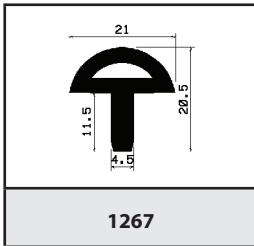

1267

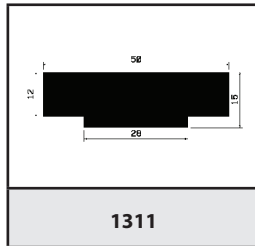

1311

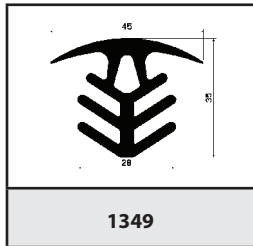

1349

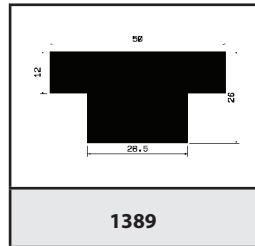

1389

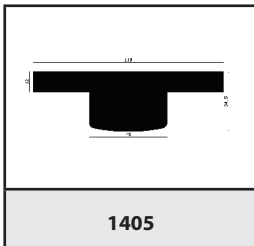

1405

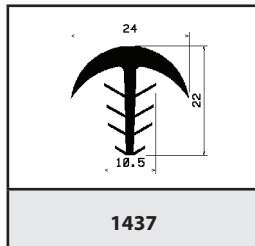

1437

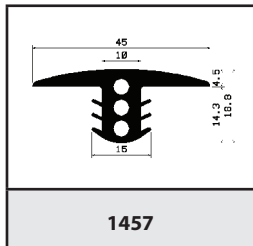

1457

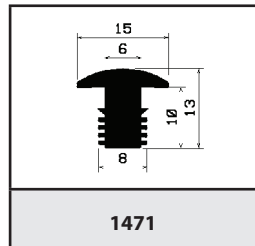

1471

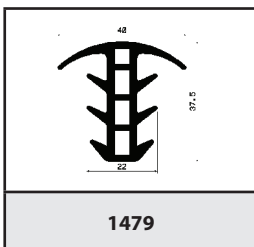

1479

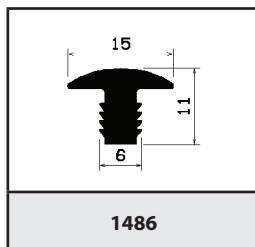

1486

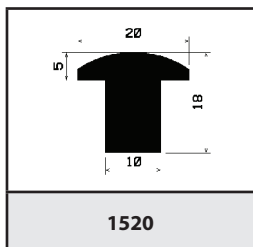

1520

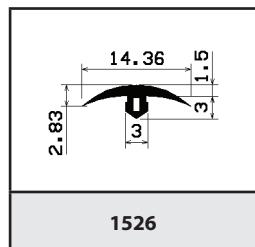

1526

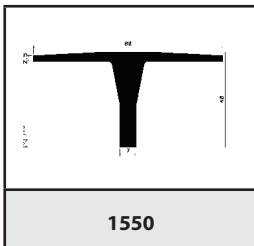

1550

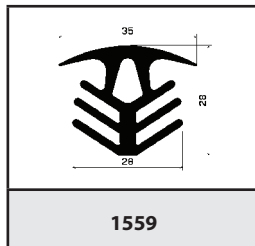

1559

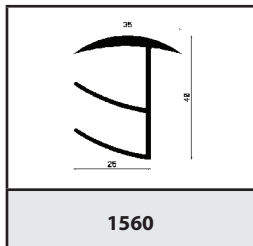

1560

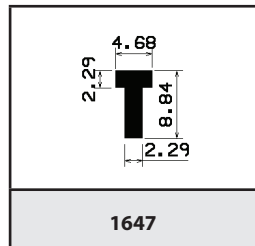

1647

○ Mikroporös-, mikroporös-/silikon- ● gummi-, silikon-

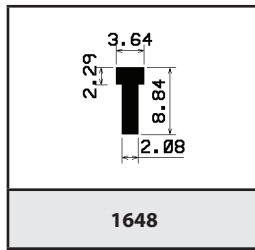

1648

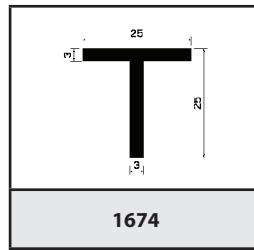

1674

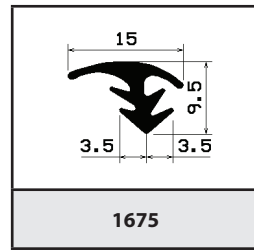

1675

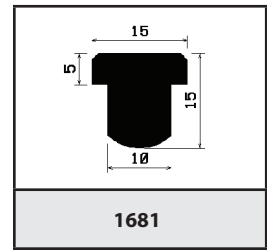

1681

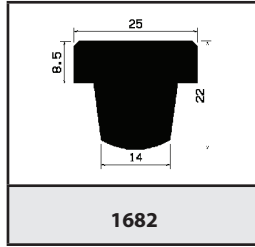

1682

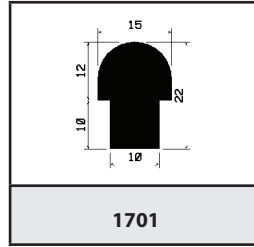

1701

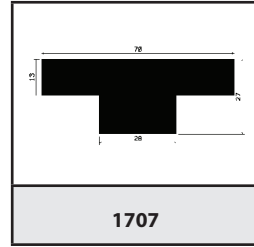

1707

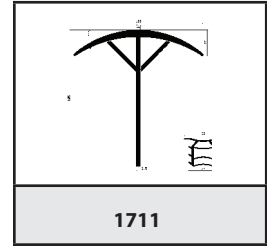

1711

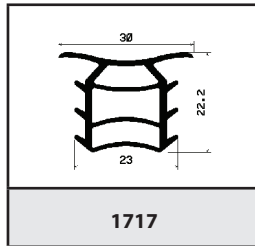

1717

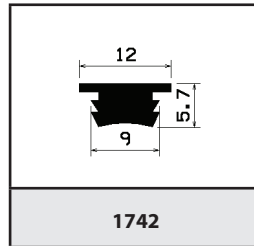

1742

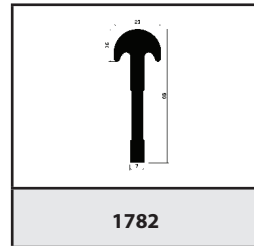

1782

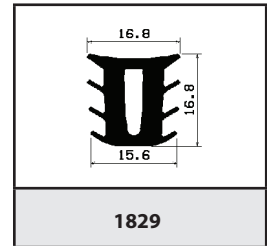

1829

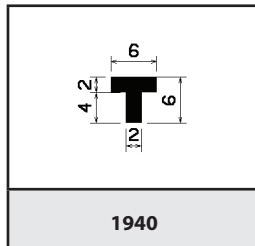

1940

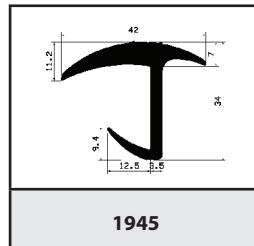

1945

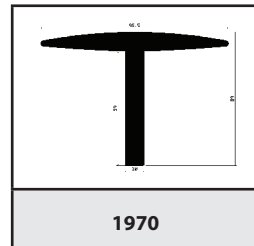

1970

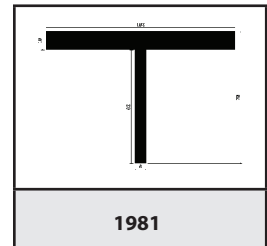

1981

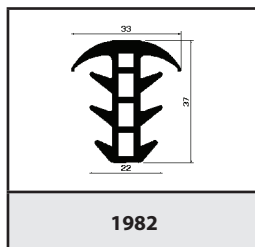

1982

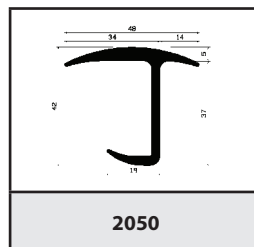

2050

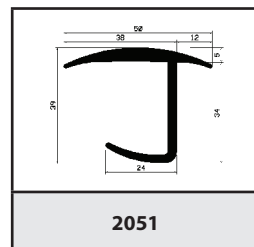

2051

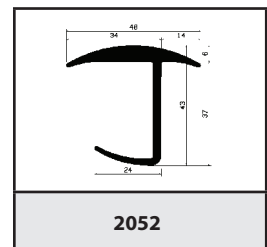

2052

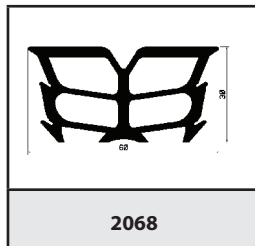

2068

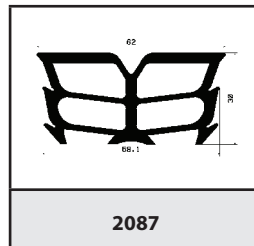

2087

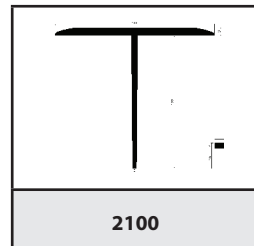

2100

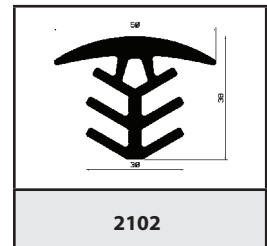

2102

○ Mikroporös-, mikroporös-/silikon- ● gummi-, silikon-

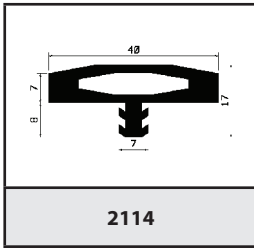

2114

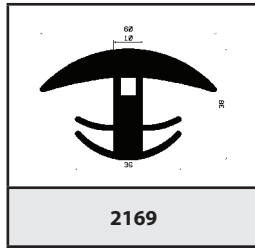

2169

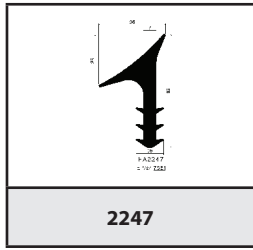

2247

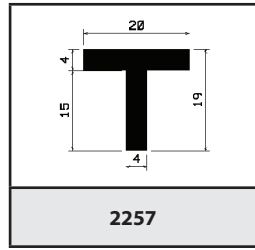

2257

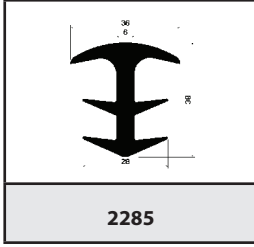

2285

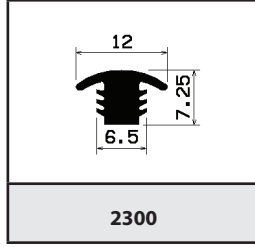

2300

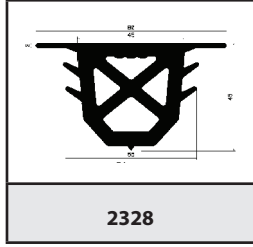

2328

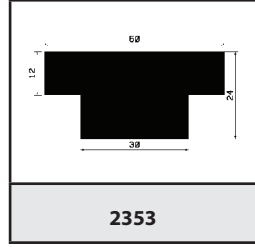

2353

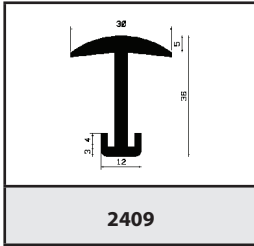

2409

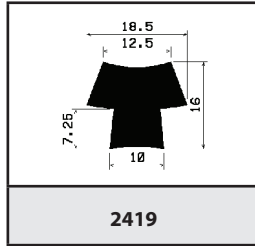

2419

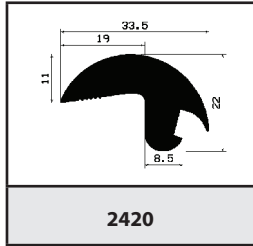

2420

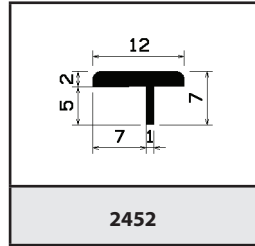

2452

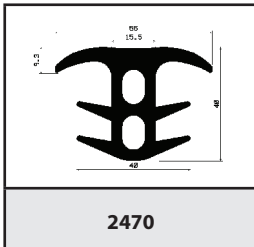

2470

○ Mikroporös-, mikroporös-/silikon-      ● gummi-, silikon-

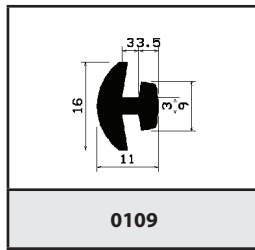

**0109**

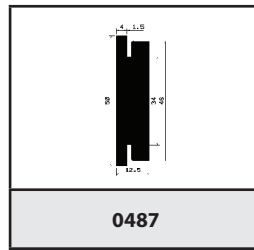

**0487**

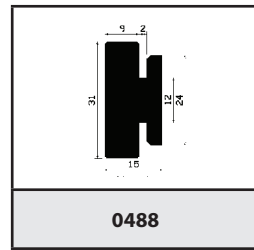

**0488**

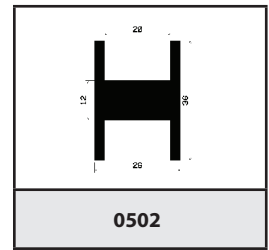

**0502**

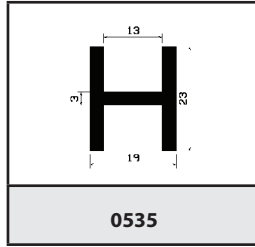

**0535**

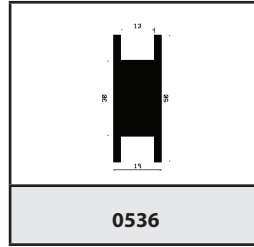

**0536**

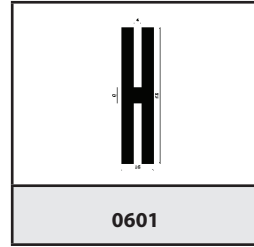

**0601**

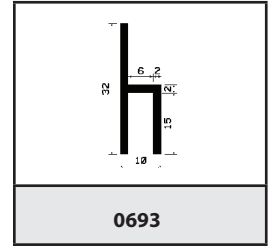

**0693**

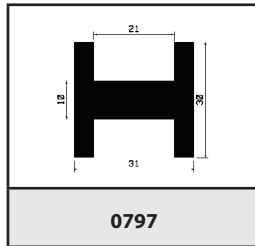

**0797**

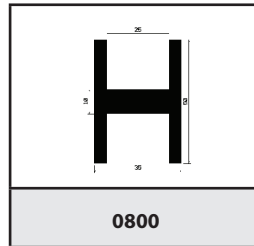

**0800**

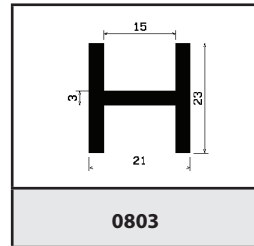

**0803**

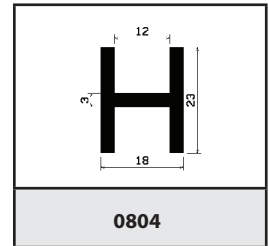

**0804**

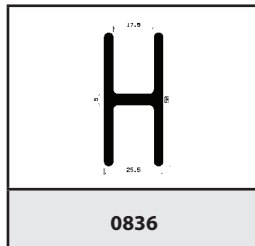

**0836**

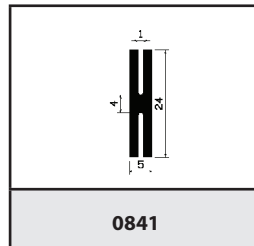

**0841**

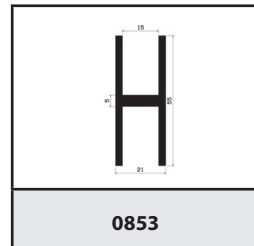

**0853**

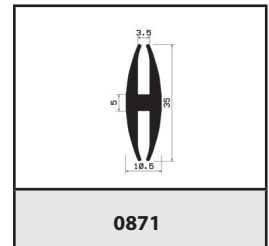

**0871**

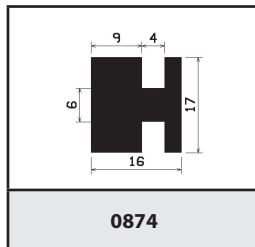

**0874**

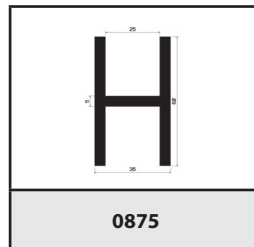

**0875**

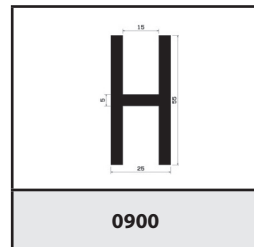

**0900**

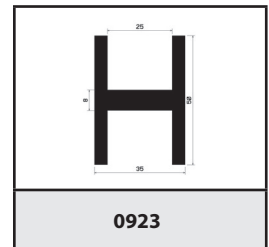

**0923**

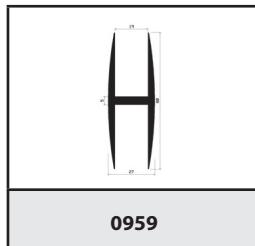

**0959**

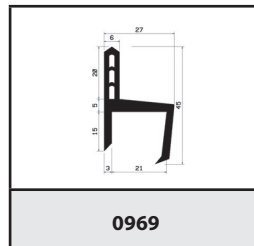

**0969**

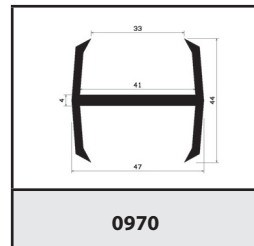

**0970**

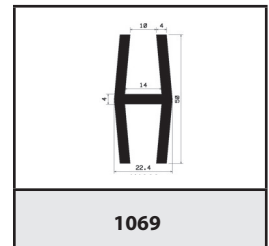

**1069**

○ Mikroporös-, mikroporös-/silikon-      ● gummi-, silikon-

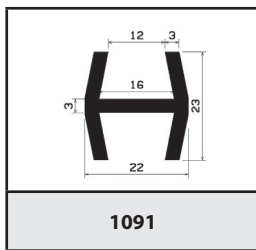

1091

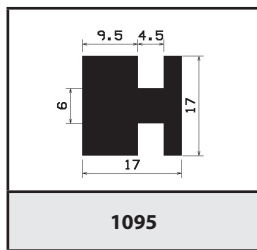

1095

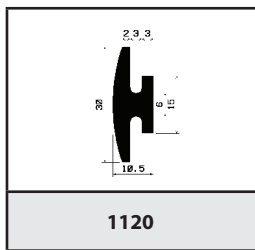

1120

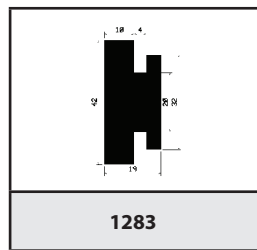

1283

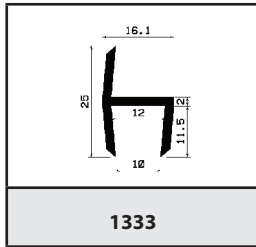

1333

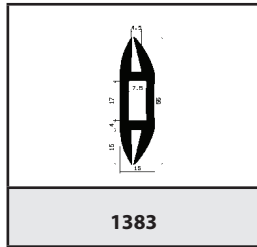

1383

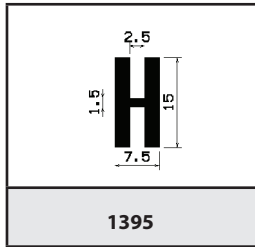

1395

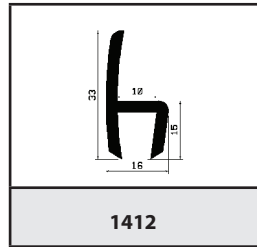

1412

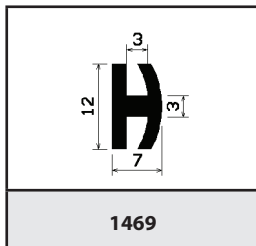

1469

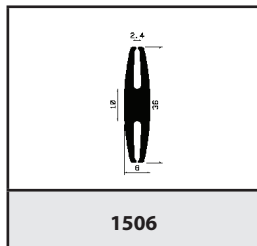

1506

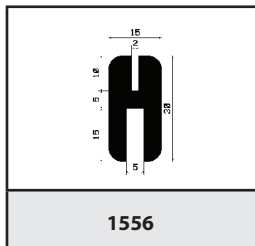

1556

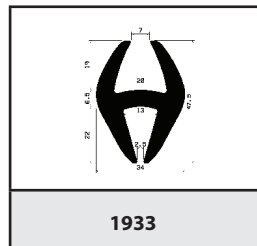

1933

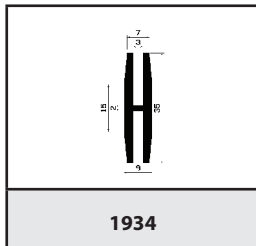

1934

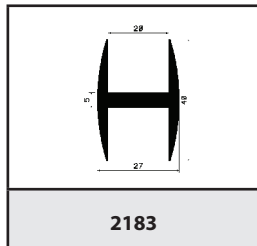

2183

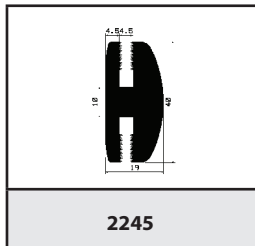

2245

○ Mikroporös-, mikroporös-/silikon-

● gummi-, silikon-



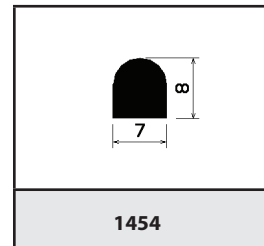
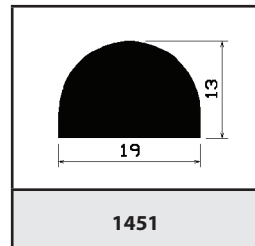
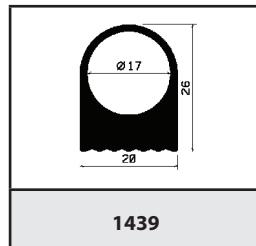
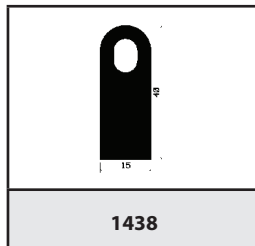
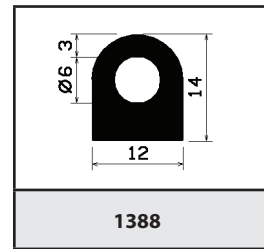
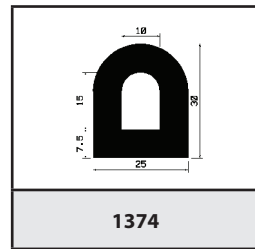
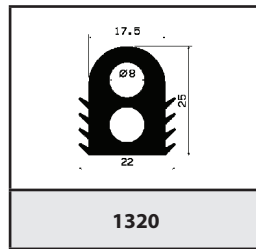
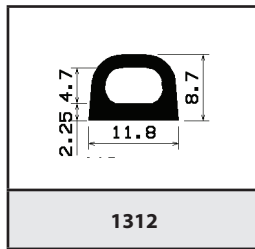
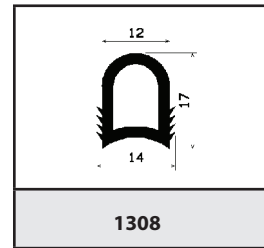
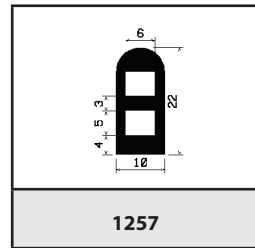
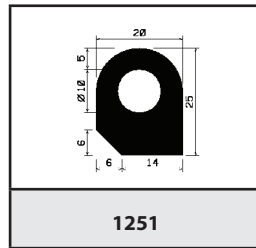
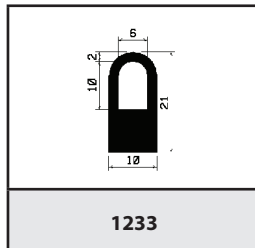
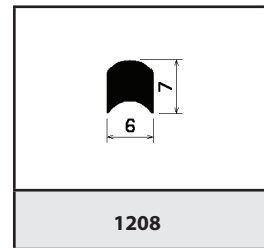
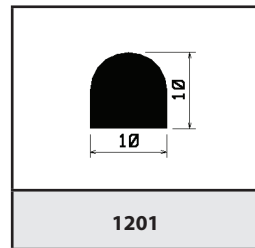
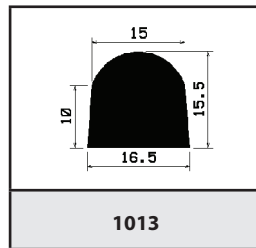
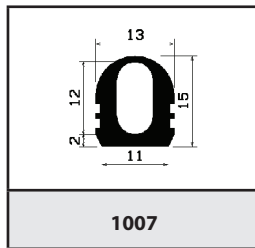
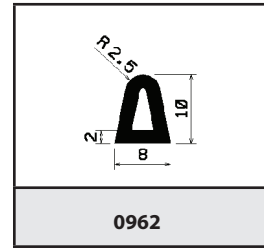
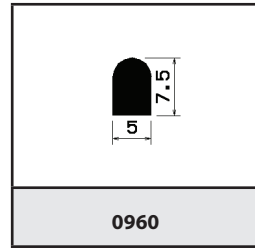
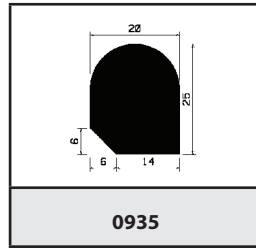
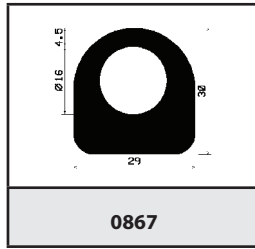
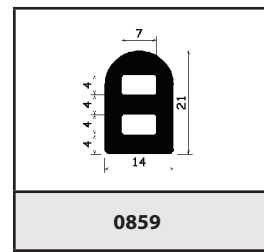
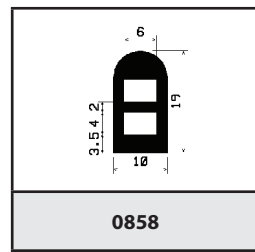
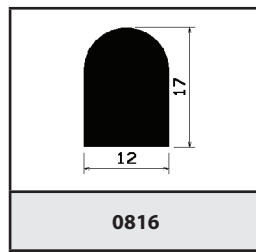
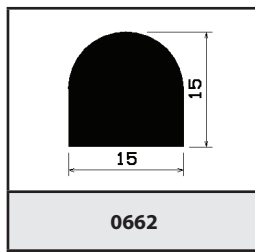

○ Mikroporös-, mikroporös-/silikon- ● gummi-, silikon-

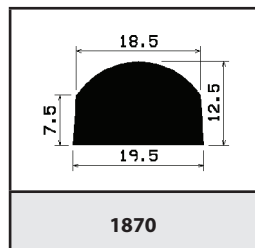
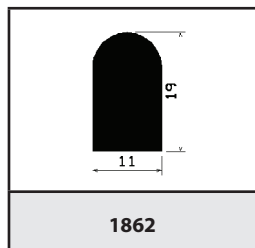
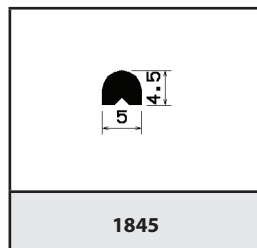
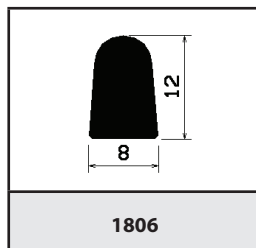
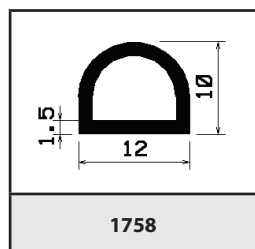
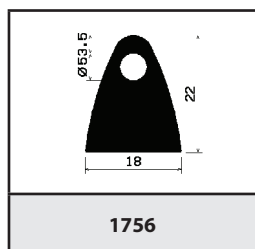
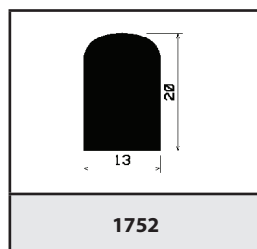
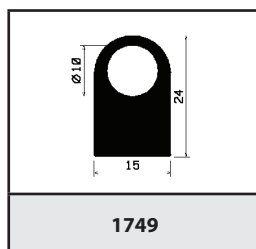
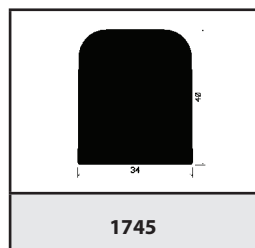
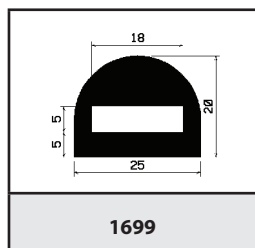
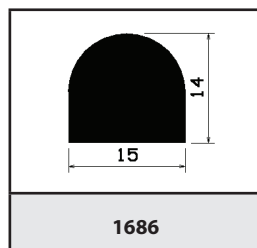
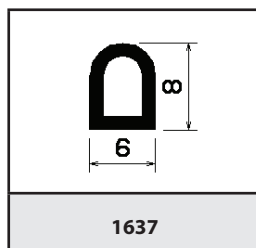
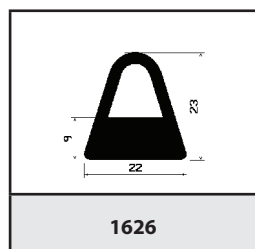
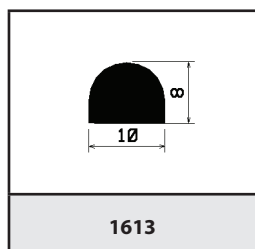
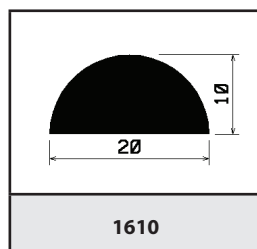
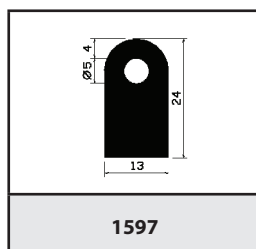
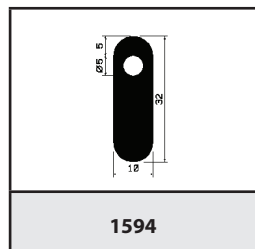
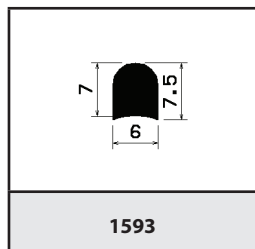
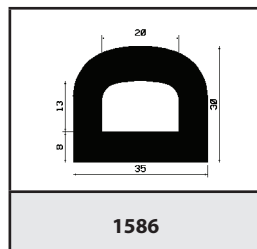
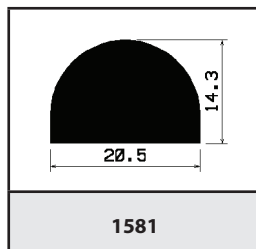
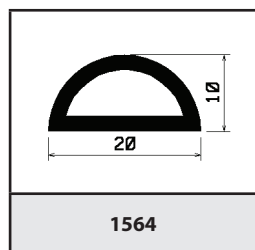
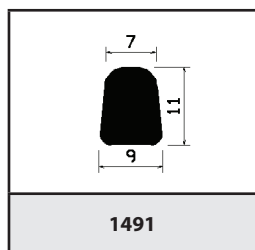
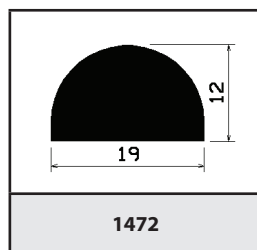
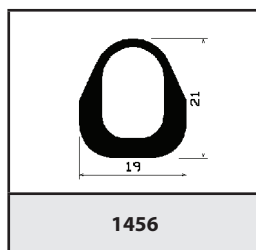

○ Mikroporös-, mikroporös-/silikon-      ● gummi-, silikon-

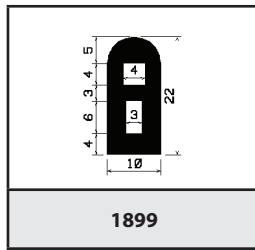

1899

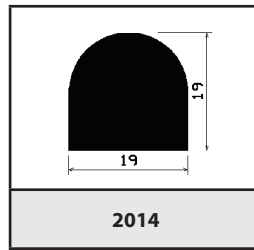

2014

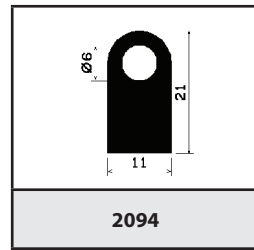

2094

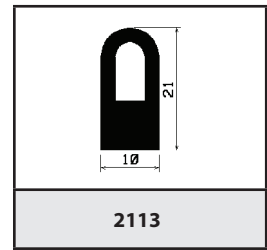

2113

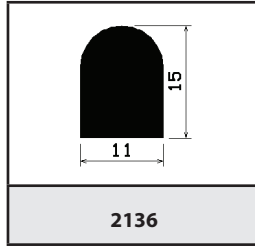

2136

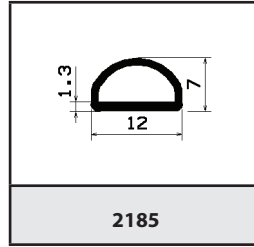

2185

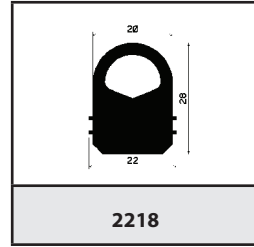

2218

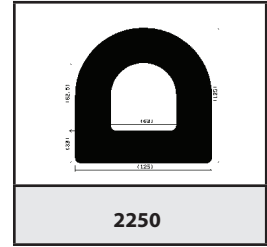

2250

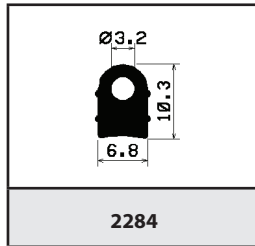

2284

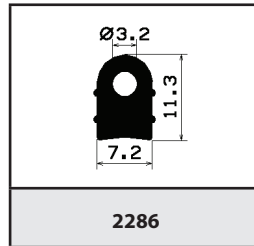

2286

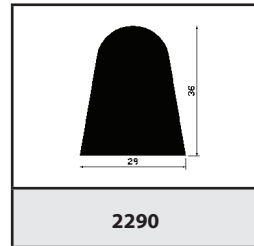

2290

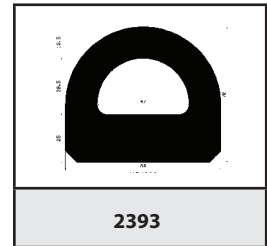

2393

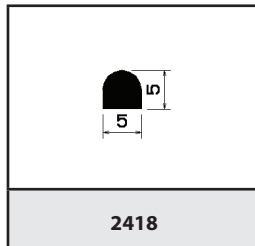

2418

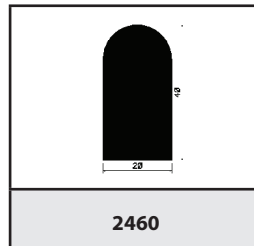

2460

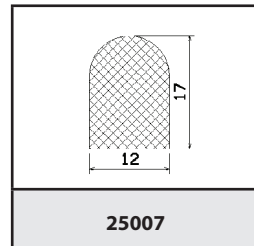

25007

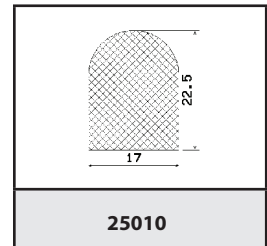

25010

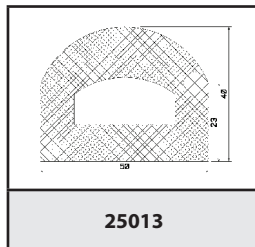

25013

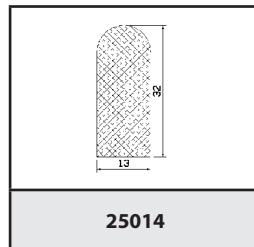

25014

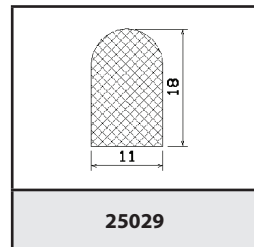

25029

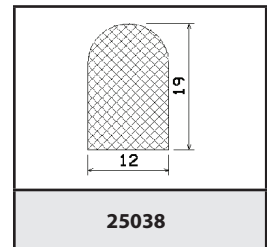

25038

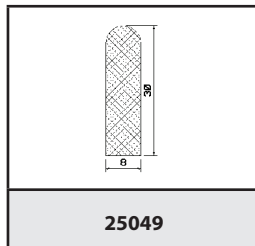

25049

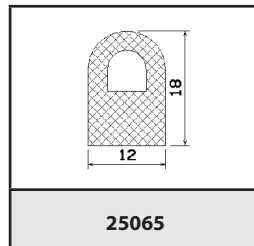

25065

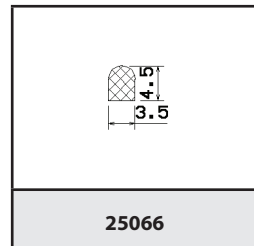

25066

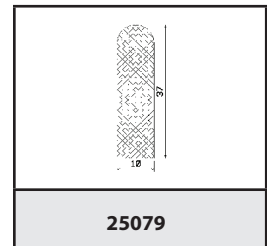

25079

○ Mikroporös-, mikroporös-/silikon-      ● gummi-, silikon-

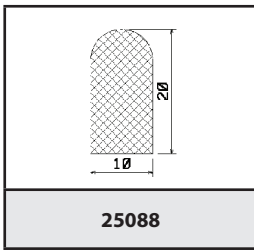

25088

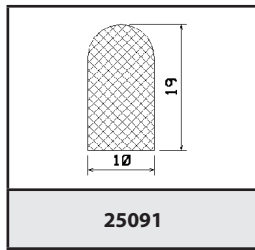

25091

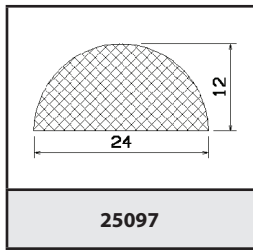

25097

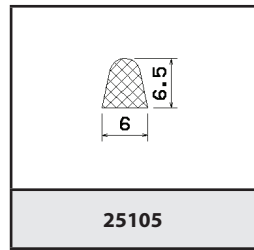

25105

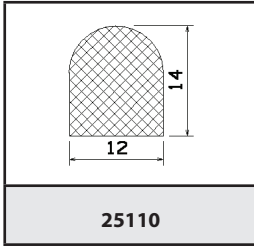

25110

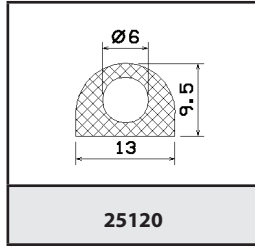

25120

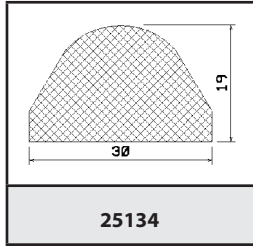

25134

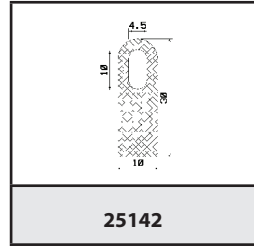

25142

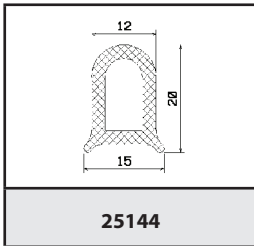

25144

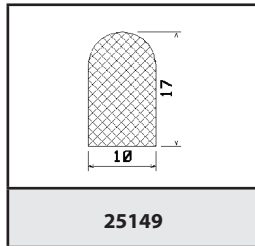

25149

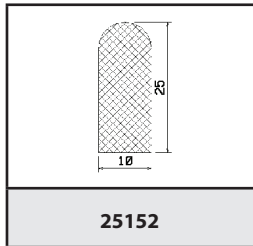

25152

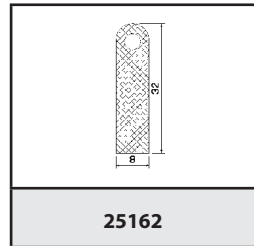

25162

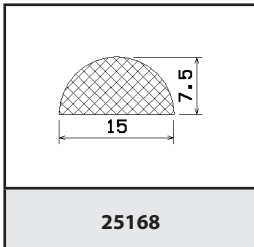

25168

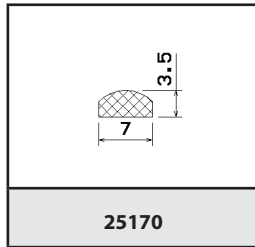

25170

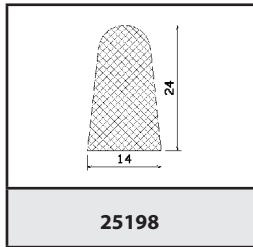

25198

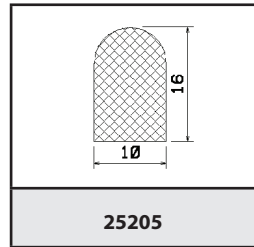

25205

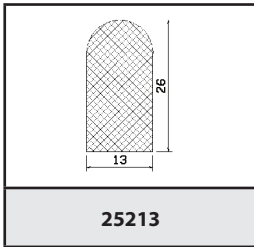

25213

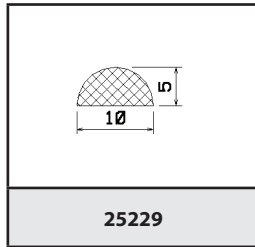

25229

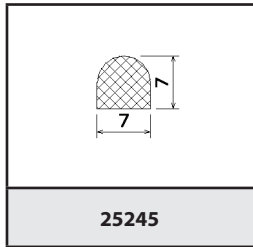

25245

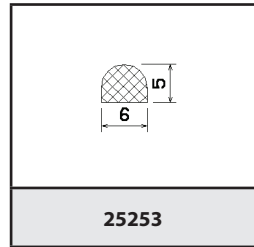

25253

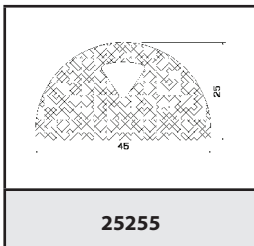

25255

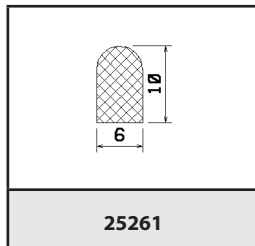

25261

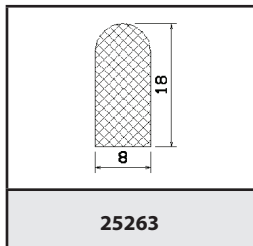

25263

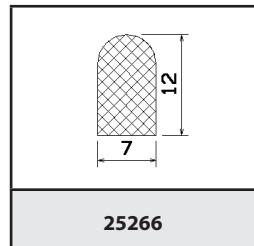

25266

○ Mikroporös-, mikroporös-/silikon-      ● gummi-, silikon-

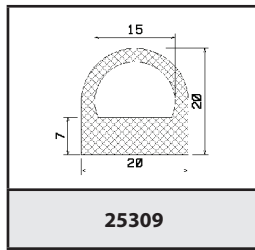

25309

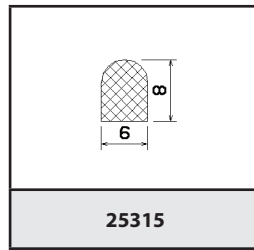

25315

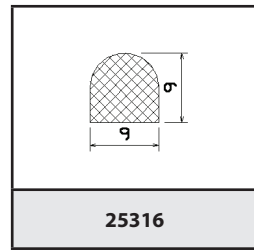

25316

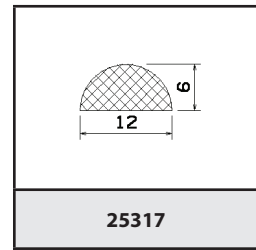

25317

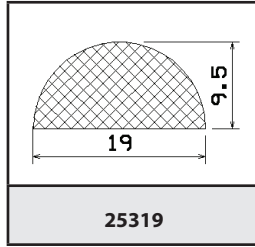

25319

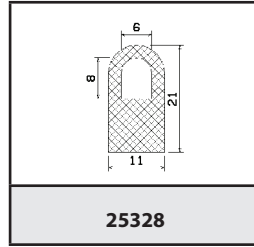

25328

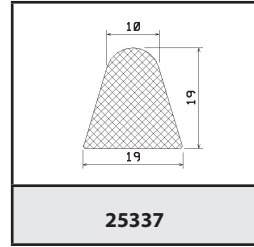

25337

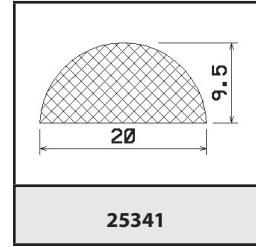

25341

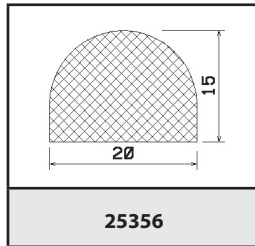

25356

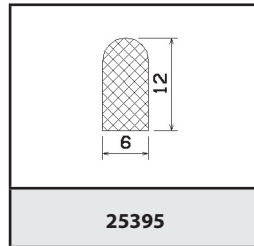

25395

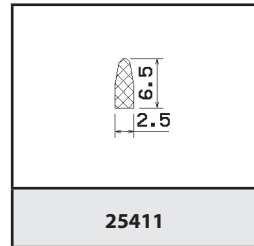

25411

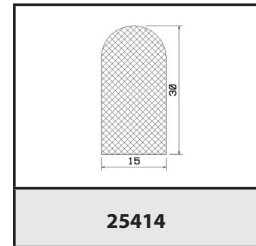

25414

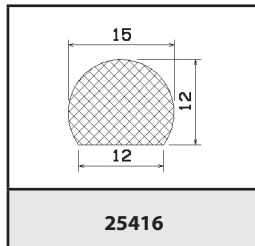

25416

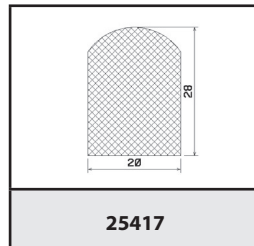

25417

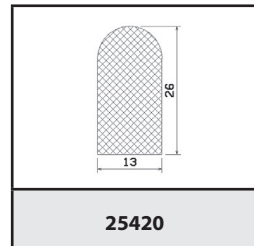

25420

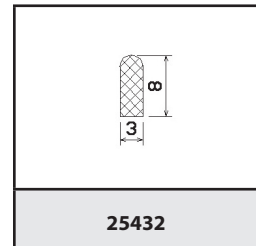

25432

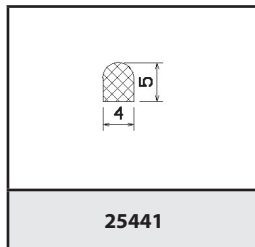

25441

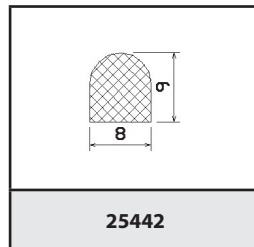

25442

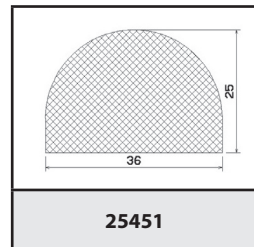

25451

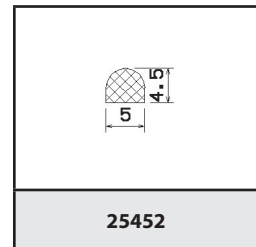

25452

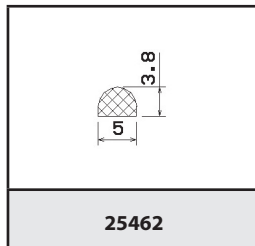

25462

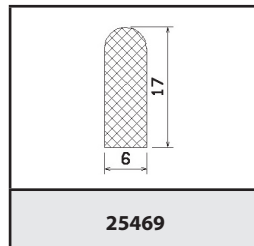

25469

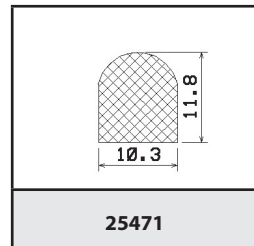



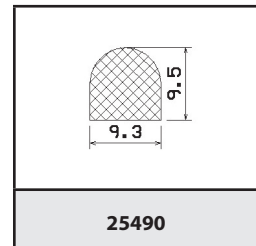

25471

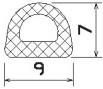
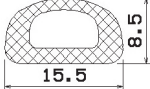

25490

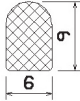
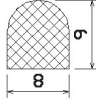
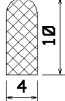
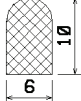
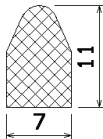
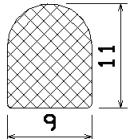
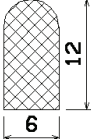
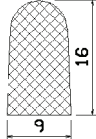
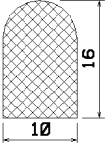
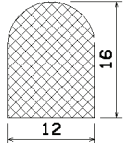
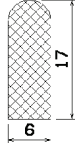
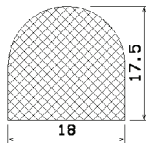
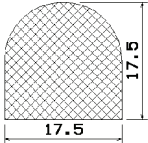
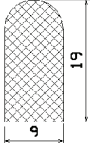
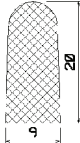
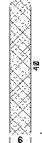
○ Mikroporös-, mikroporös-/silikon- ● gummi-, silikon-

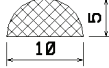
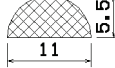
			
25496	25497	25511	25512
			
25513	25514	25515	25516
			
25517	25518	25519	25521
			
25522	25523	25525	25526
			
25527	25528	25529	25531
			
25532	25533	25534	25535

○ Mikroporös-, mikroporös-/silikon-      ● gummi-, silikon-

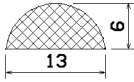
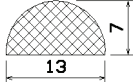
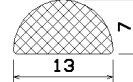
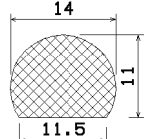
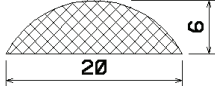
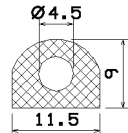
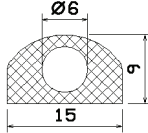
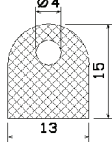
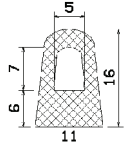
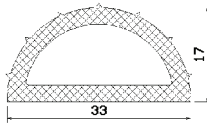
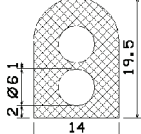
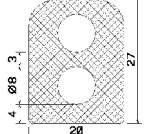
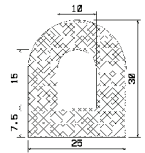
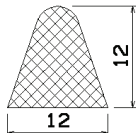
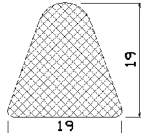
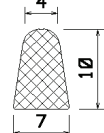
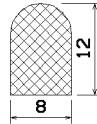
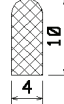
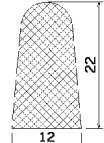
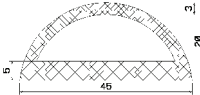
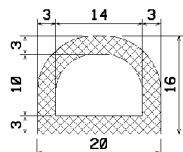
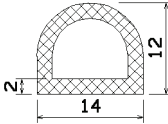
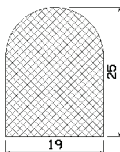
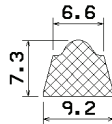
			
25537	25538	25539	25540
			
25541	25553	25554	25555
			
25556	25557	25558	25559
			
25560	25630	25633	25653
			
25654	25669	25672	25700
			
25702	25716	25717	25731

○ Mikroporös-, mikroporös-/silikon-      ● gummi-, silikon-

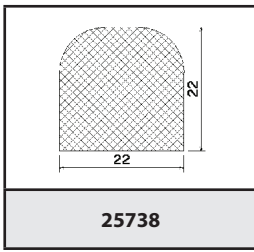

25738

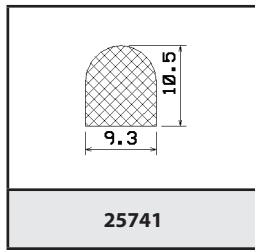

25741

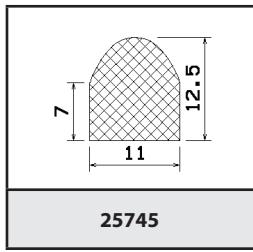

25745

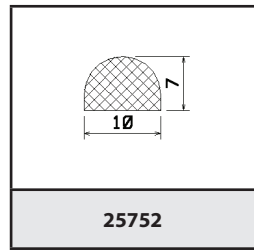

25752

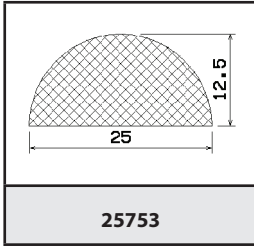

25753

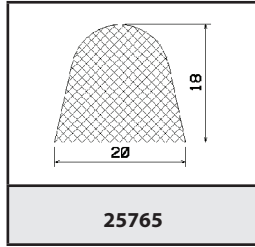

25765

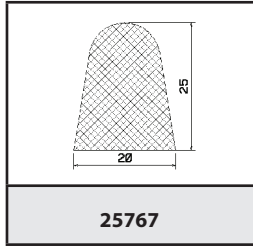

25767

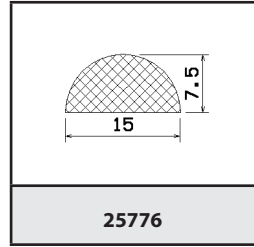

25776

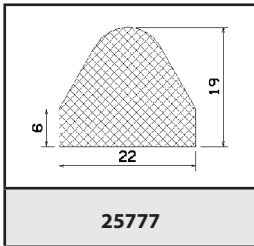

25777

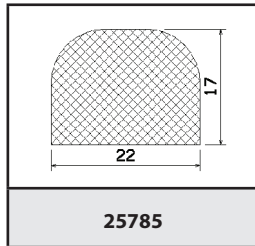

25785

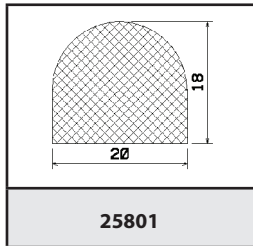

25801

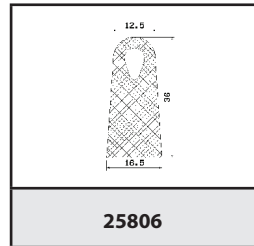

25806

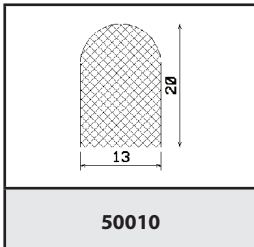

50010

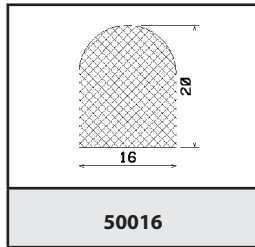

50016

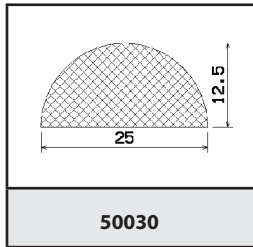

50030

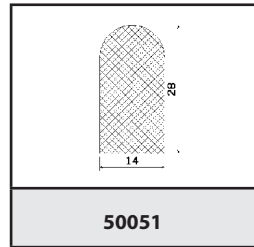

50051

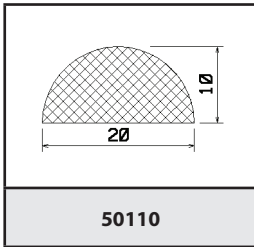

50110

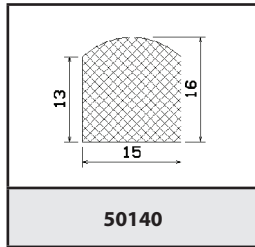

50140

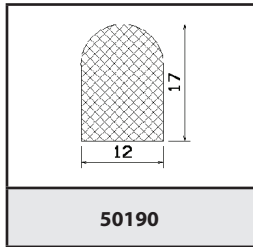

50190

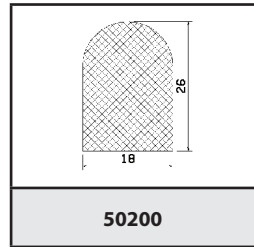

50200

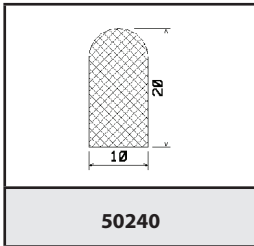

50240

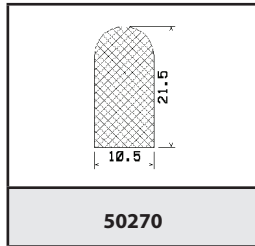

50270

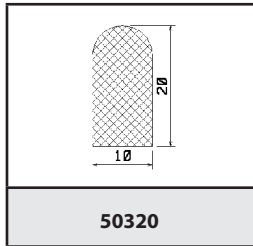

50320

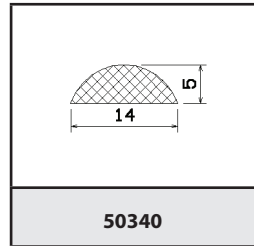

50340

○ Mikroporös-, mikroporös-/silikon-      ● gummi-, silikon-



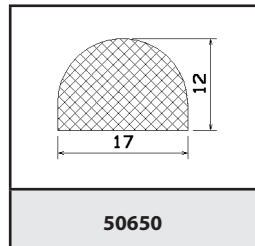
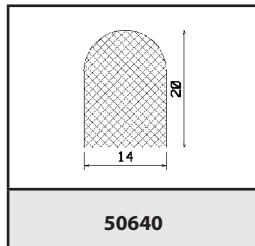
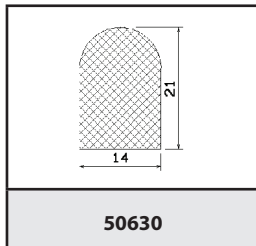
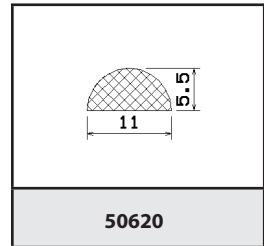
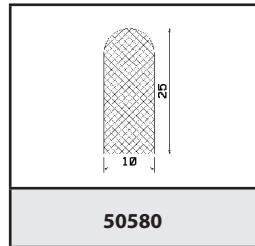
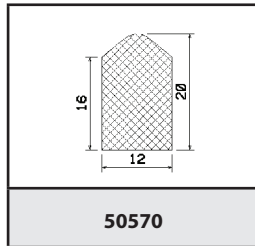
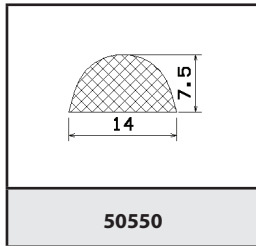
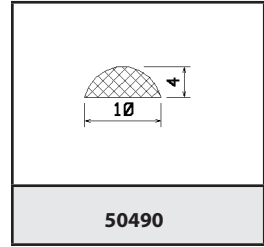
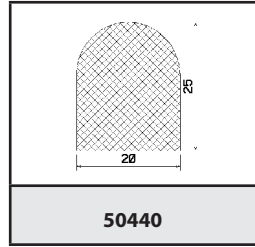
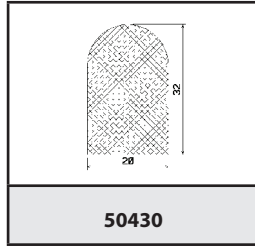
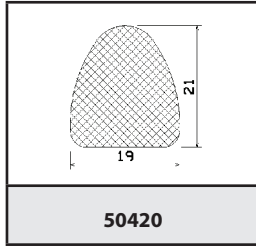
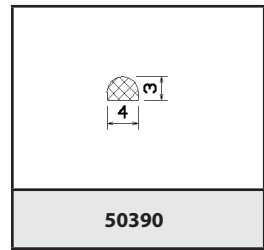
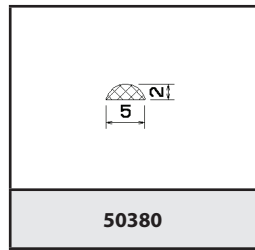
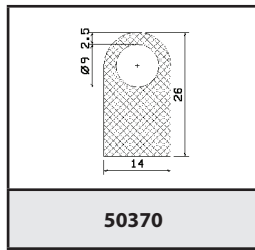
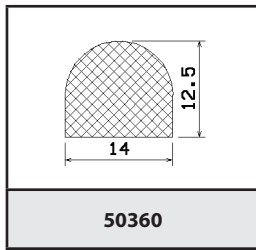

○ Mikroporös-, mikroporös-/silikon- ● gummi-, silikon-

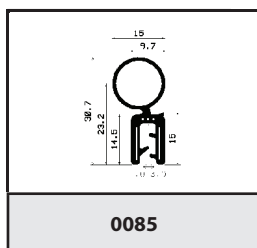

○ Mikroporös-, mikroporös-/silikon-      ● gummi-, silikon-

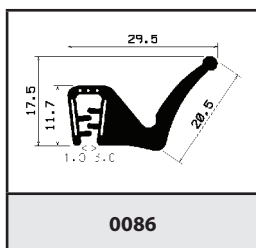

0085

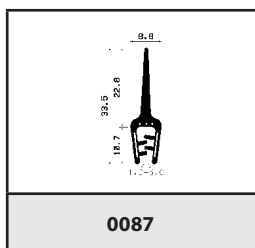

0086



0087

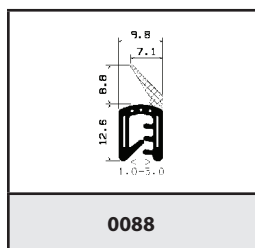

0088

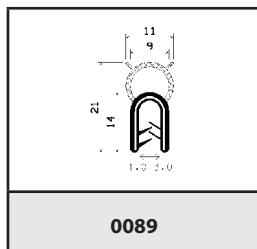

0089

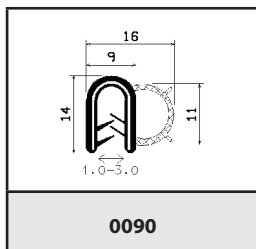

0090

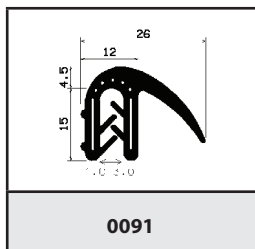

0091

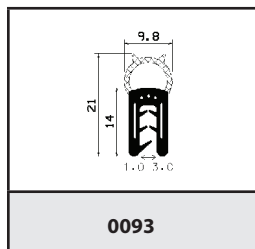

0093

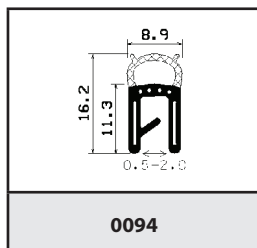

0094

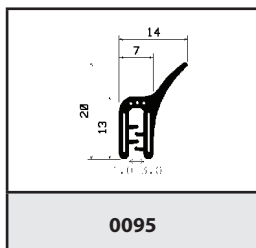

0095

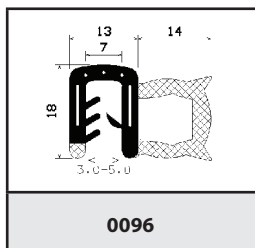

0096

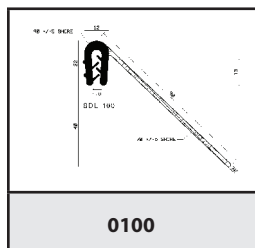

0100

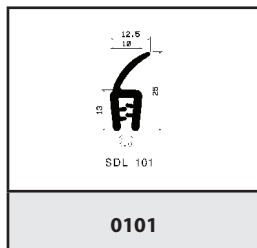

0101

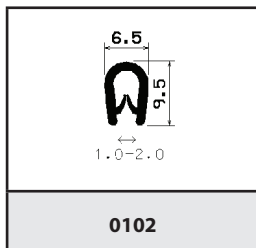

0102

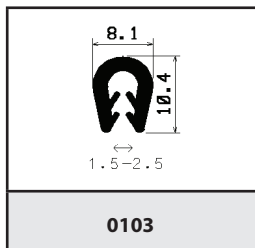

0103

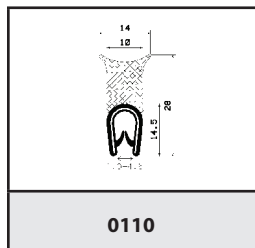

0110

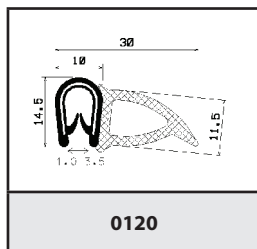

0120

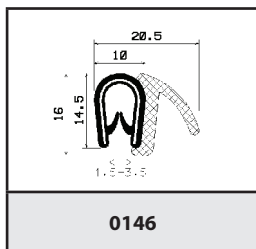

0146

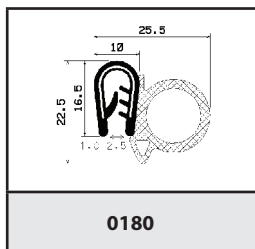

0180

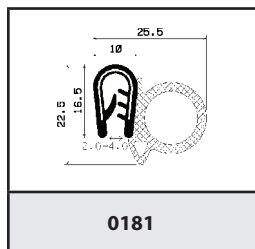

0181

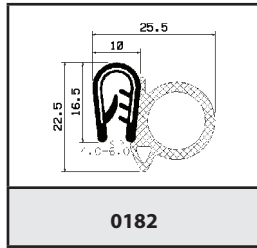

0182

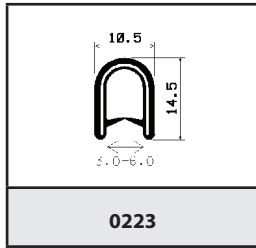

0223

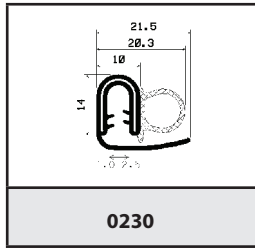

0230

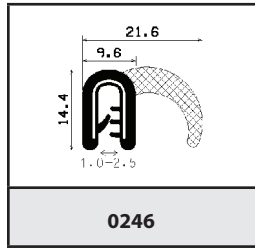

0246

○ Mikroporös-, mikroporös-/silikon-      ● gummi-, silikon-

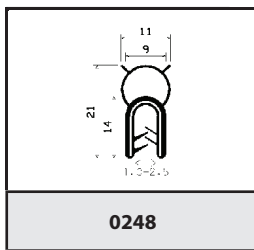

**0248**

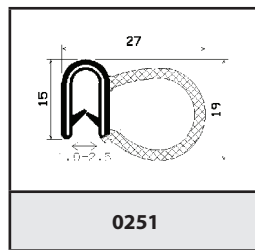

**0251**

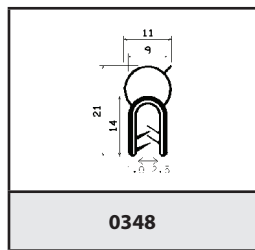

**0348**

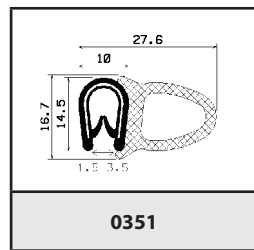

**0351**

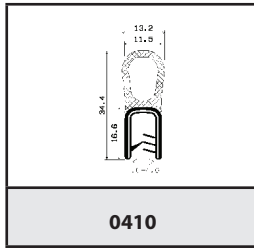

**0410**

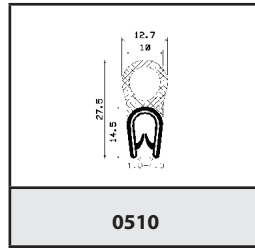

**0510**

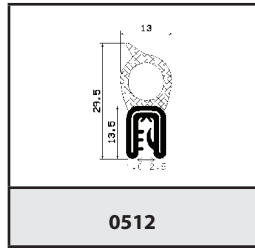

**0512**

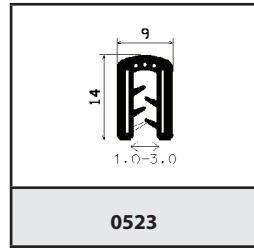

**0523**

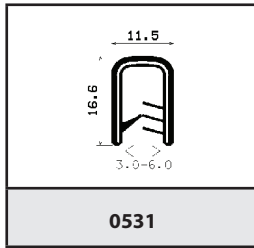

**0531**

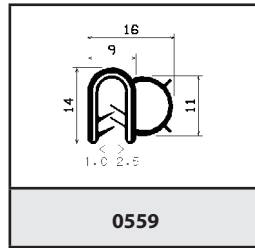

**0559**

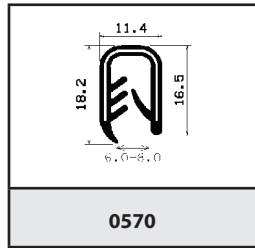

**0570**

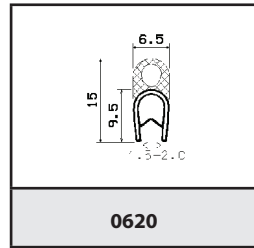

**0620**

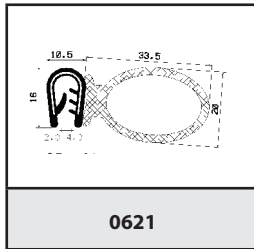

**0621**

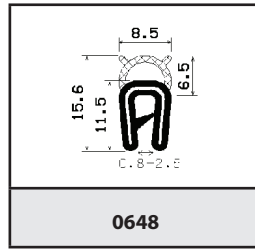

**0648**

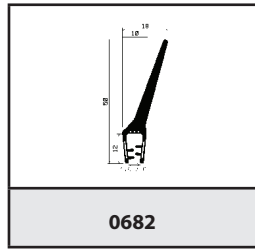

**0682**

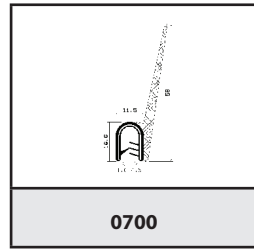

**0700**

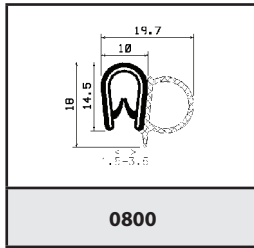

**0800**

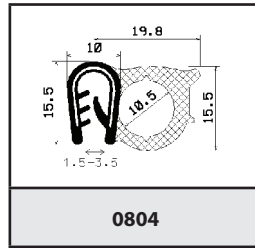

**0804**

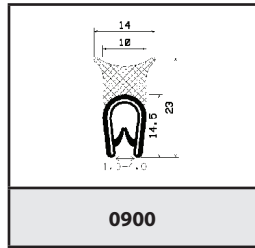

**0900**

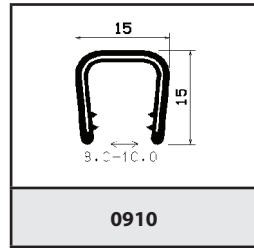

**0910**

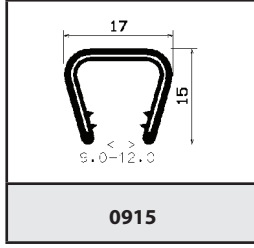

**0915**

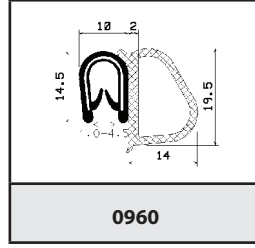

**0960**

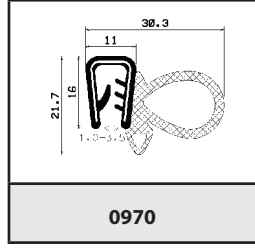

**0970**

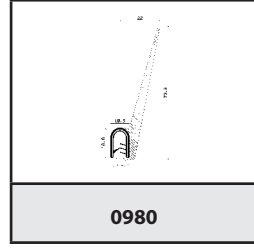

**0980**



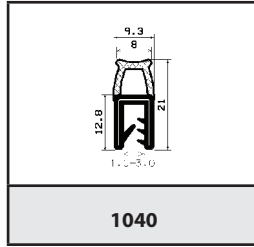
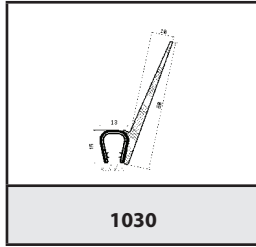
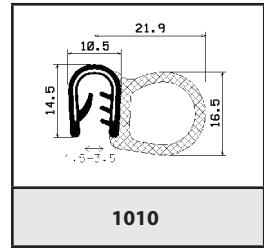
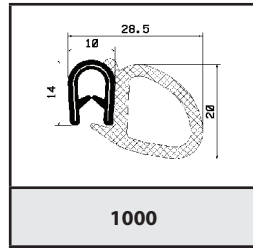
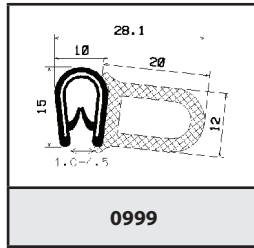
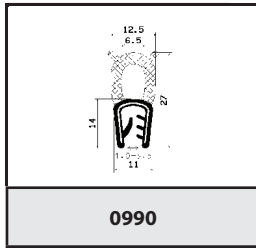



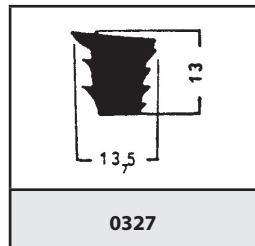
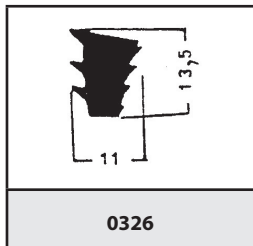
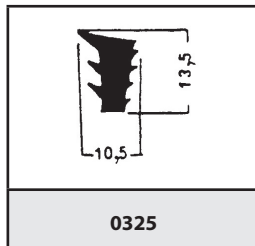
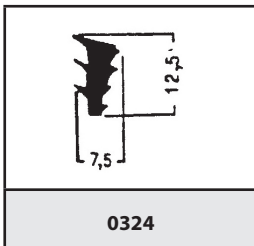
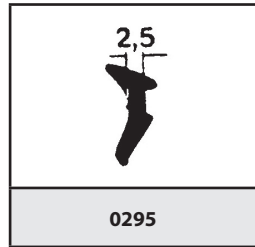
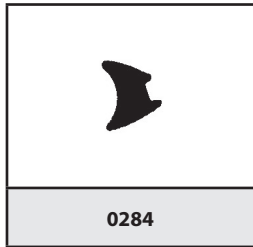
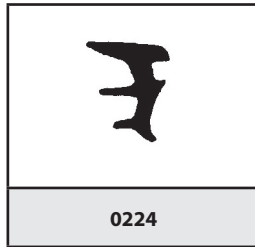
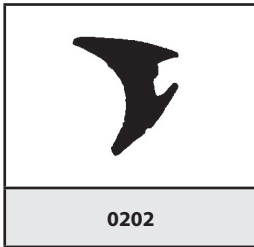
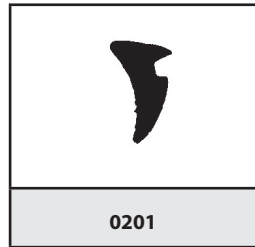
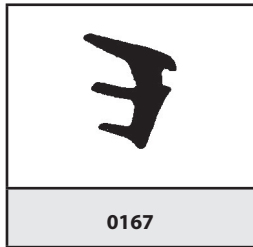
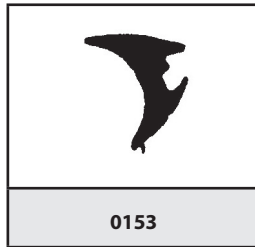
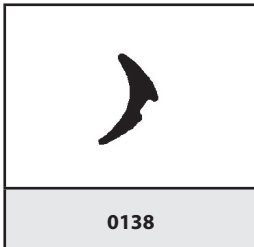
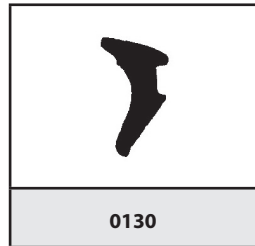
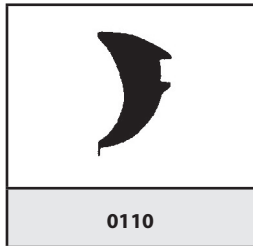
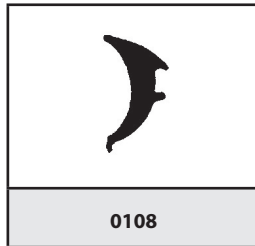
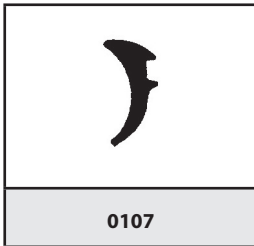
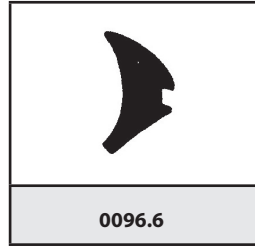
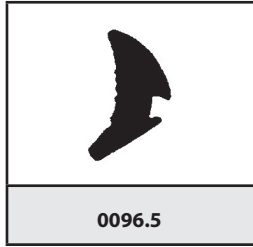
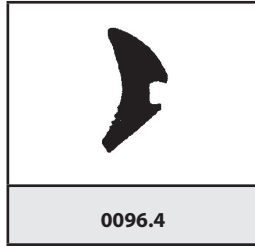
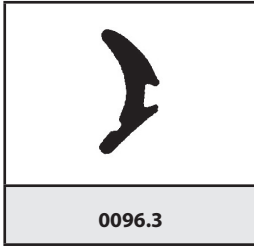
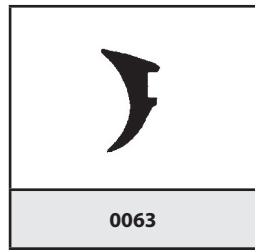
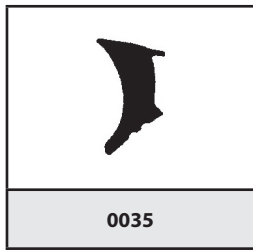
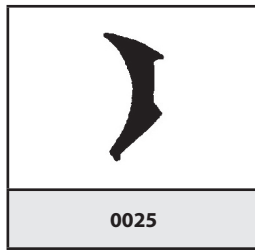
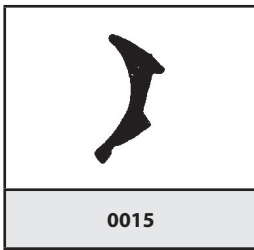















○ Mikroporös-, mikroporös-/silikon-      ● gummi-, silikon-



○ Mikroporös-, mikroporös-/silikon-    ● gummi-, silikon-



○ Mikroporös-, mikroporös-/silikon-      ● gummi-, silikon-

			
0328	0329	0385	0388
			
0462	0512	0519	0631
			
1136	1136.1	1136.2	1145
			
1146	1146.2	1165	1381
			
1516	1601	1684	1715
			
2025	2206		

○ Mikroporös-, mikroporös-/silikon-      ● gummi-, silikon-

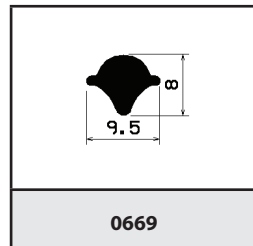
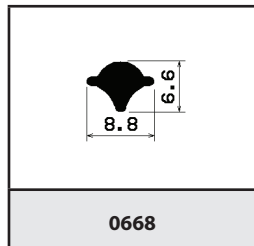
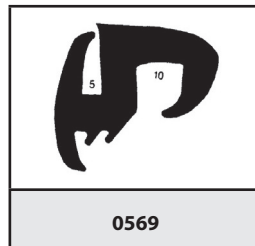
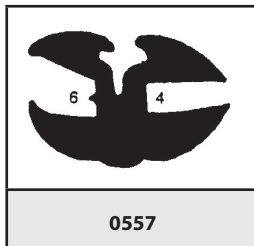
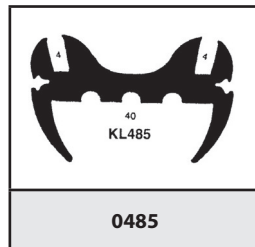
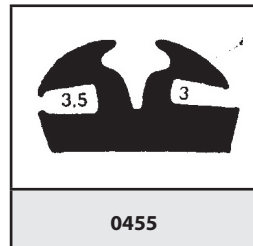
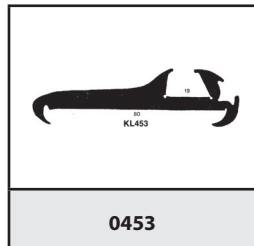
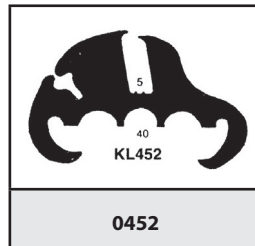
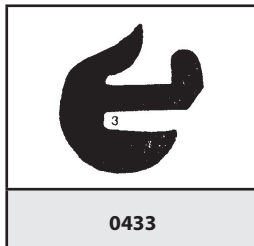
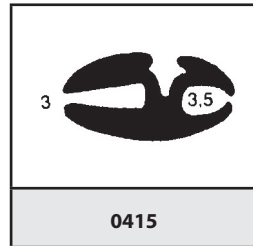
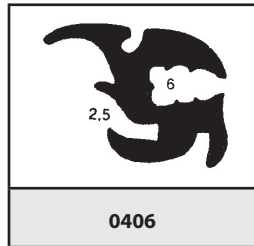
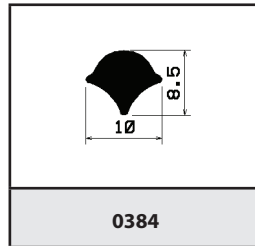
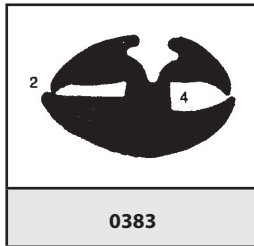
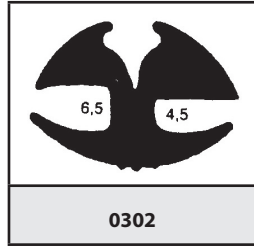
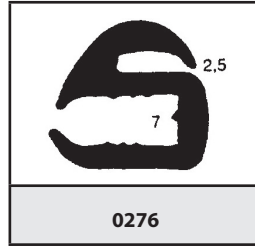
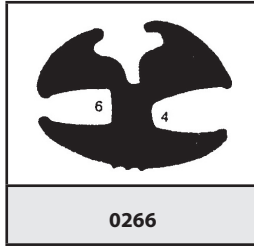
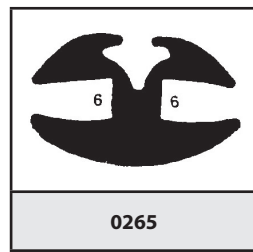
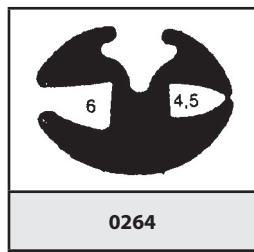
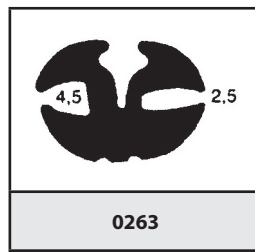
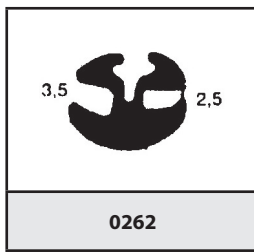

○ Mikroporös-, mikroporös-/silikon-      ● gummi-, silikon-



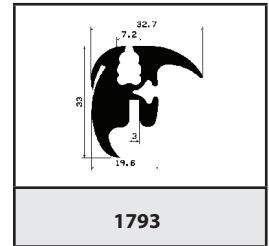
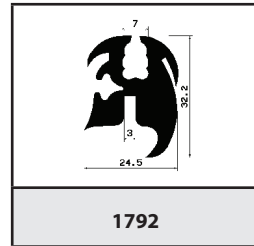
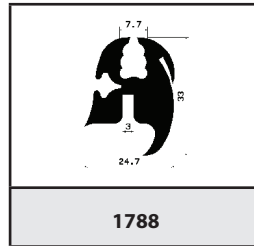
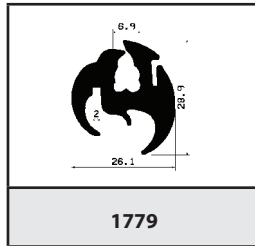
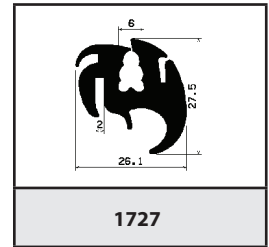
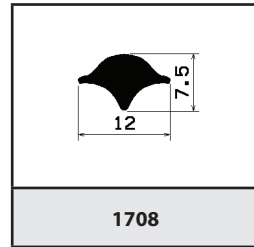
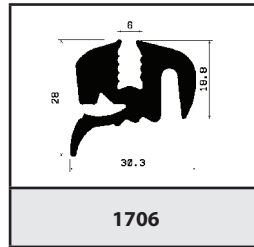
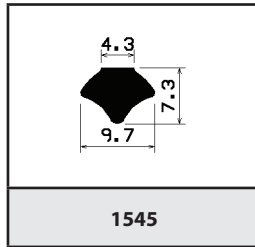
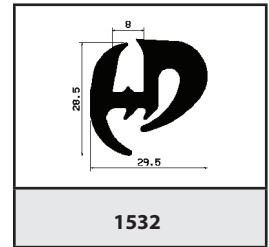
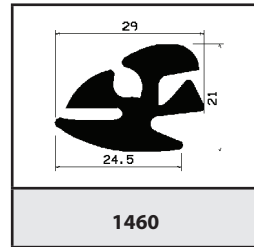
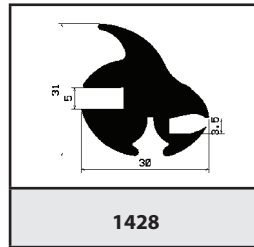
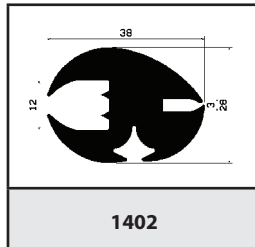
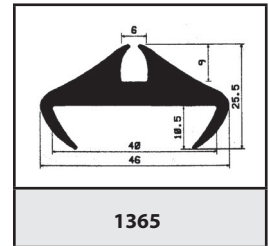
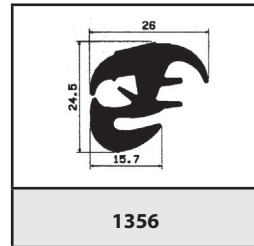
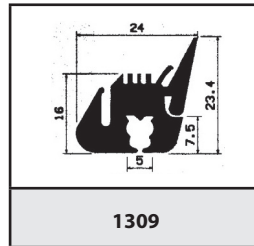
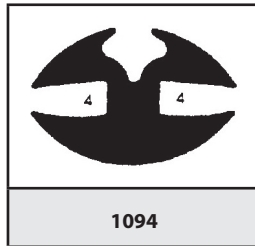
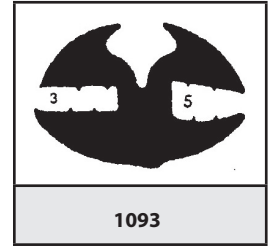
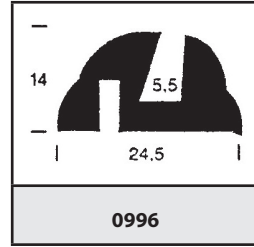
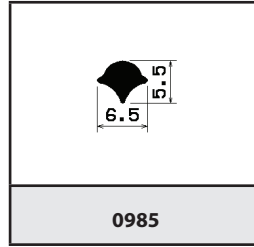
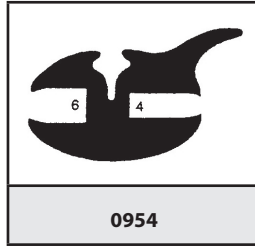
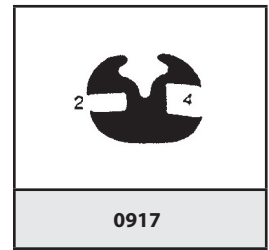
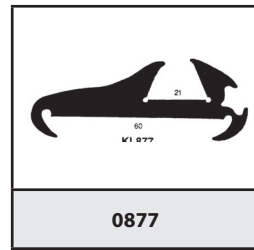
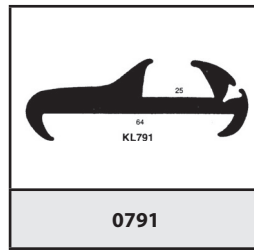
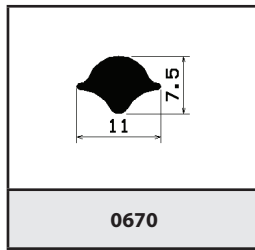

○ Mikroporös-, mikroporös-/silikon-      ● gummi-, silikon-

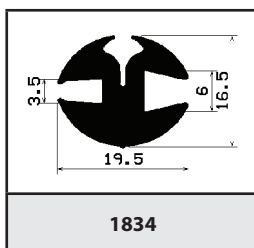

1834

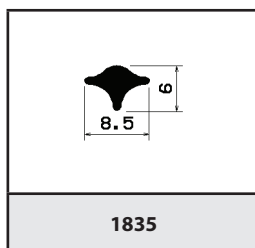

1835

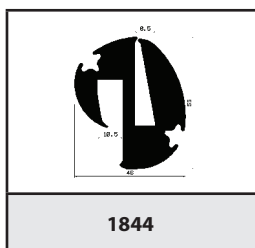

1844

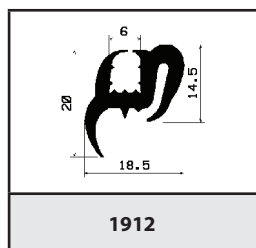

1912

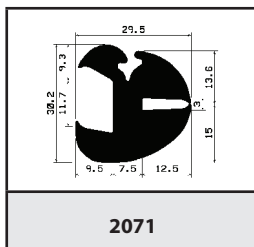

2071

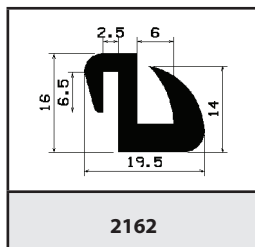

2162

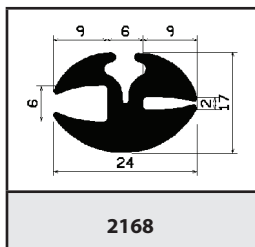

2168

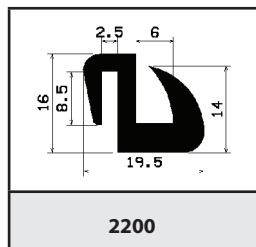

2200

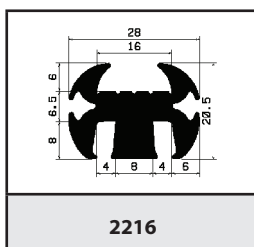

2216

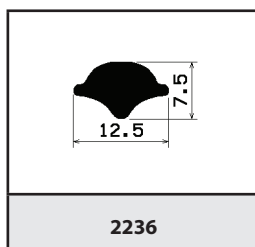

2236

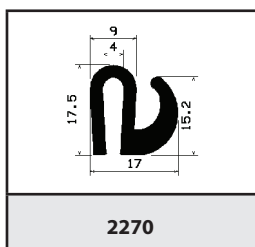

2270

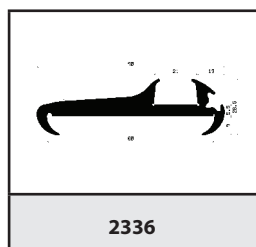

2336

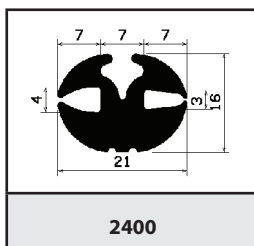

2400

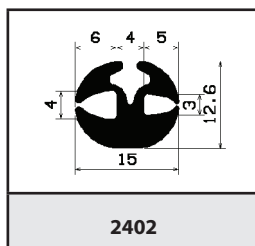



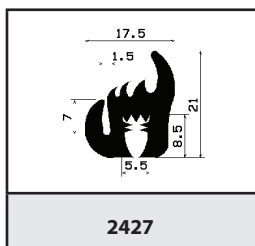







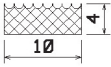
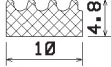

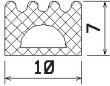

2402

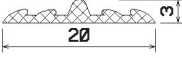

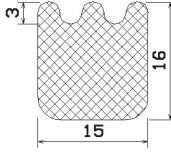
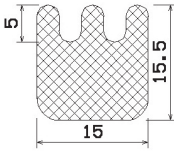
2427

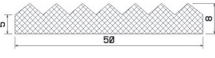
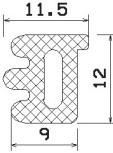
○ Mikroporös-, mikroporös-/silikon-

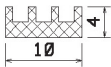
● gummi-, silikon-

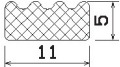
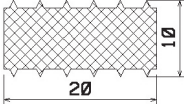
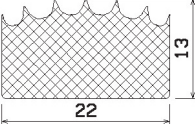
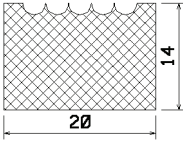
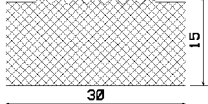
			
25076	25080	25084	25174
			
25175	25176.1	25176.2	25177
			
25220	25247	25302	25318
			
25346	25371	25443	25463
			
25606	25607	25608	25609
			
25610	25611	25612	25613

○ Mikroporös-, mikroporös-/silikon- ● gummi-, silikon-

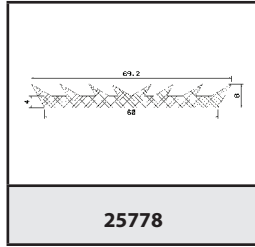
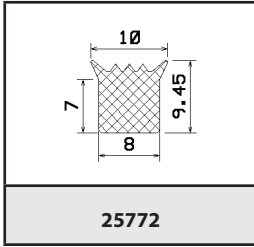
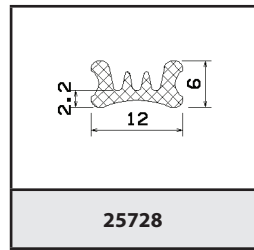
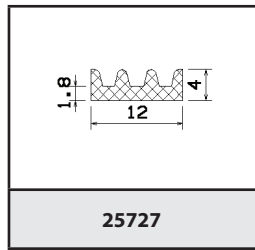
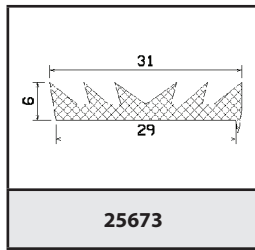
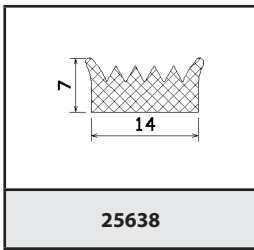

○ Mikroporös-, mikroporös-/silikon-

● gummi-, silikon-

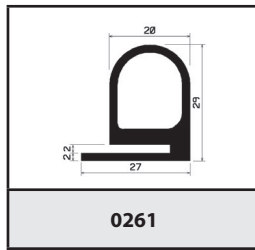

0261

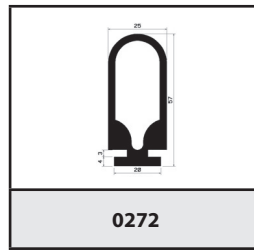

0272

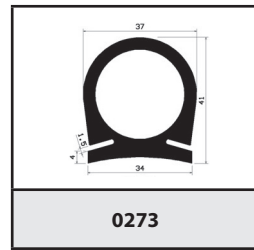

0273

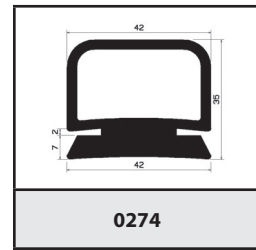

0274

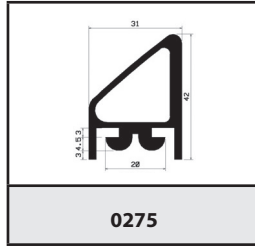

0275

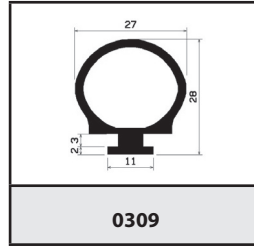

0309

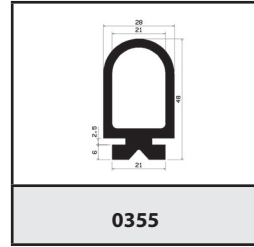

0355

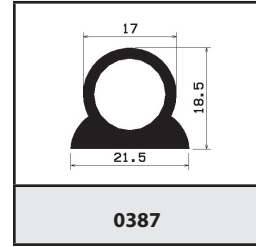

0387

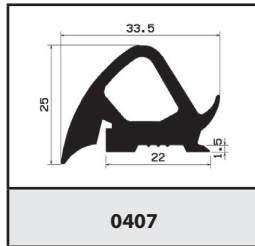

0407

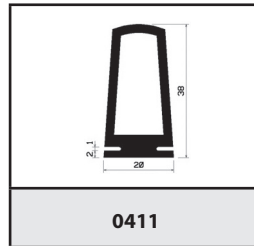

0411

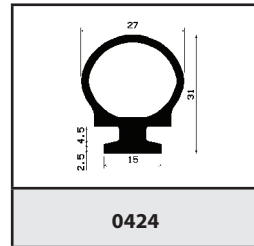

0424

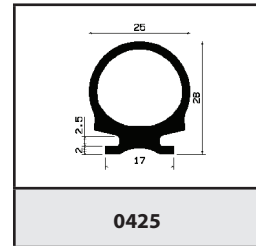

0425

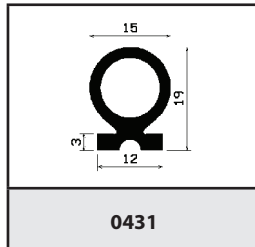

0431

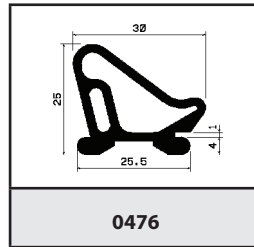

0476

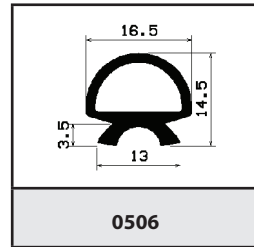

0506

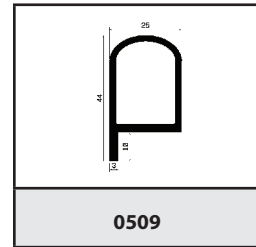

0509

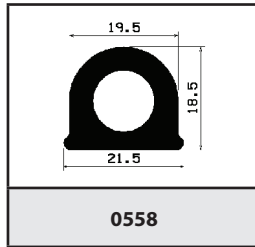

0558

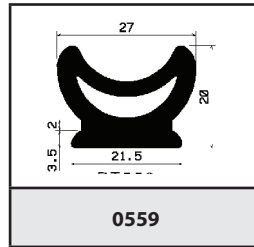

0559

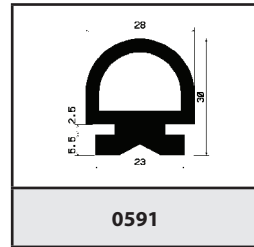

0591

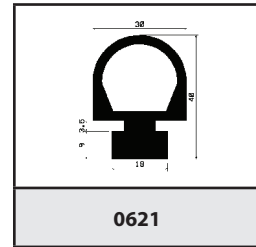

0621

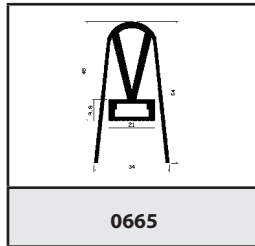

0665

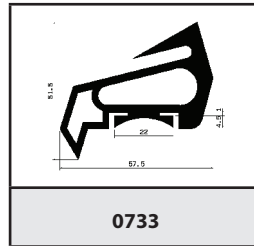

0733

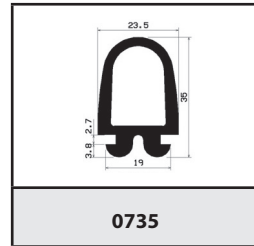

0735

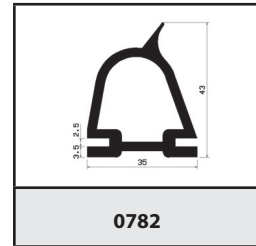

0782

○ Mikroporös-, mikroporös-/silikon- ● gummi-, silikon-

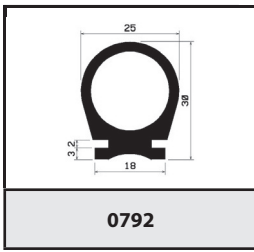

0792

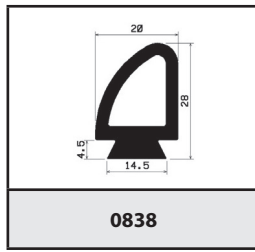

0838

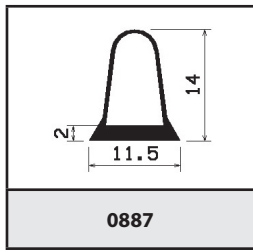

0887

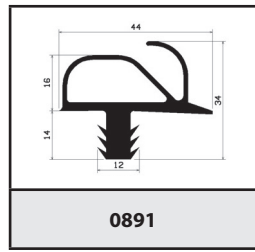

0891

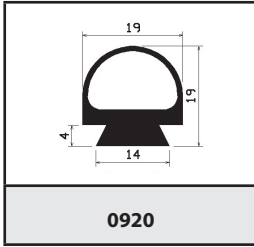

0920

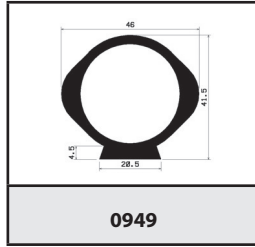

0949

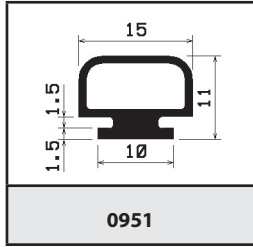

0951

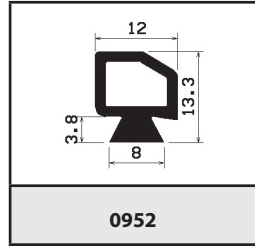

0952

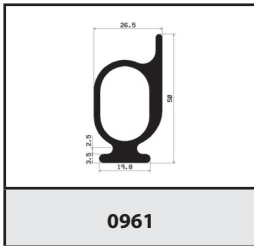

0961

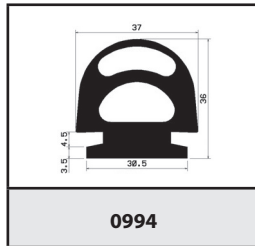

0994

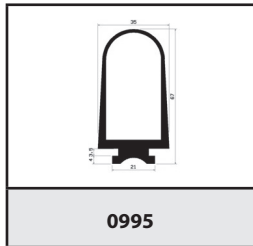

0995

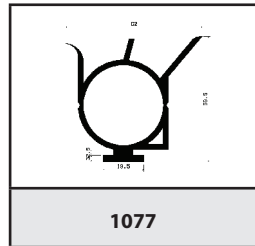

1077

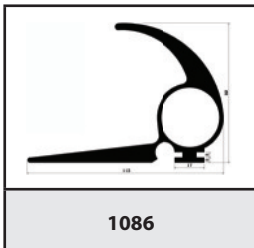

1086

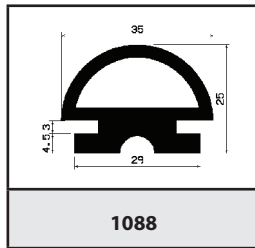

1088

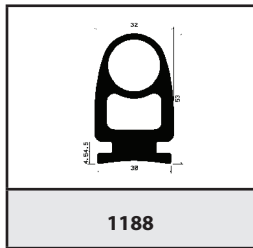

1188

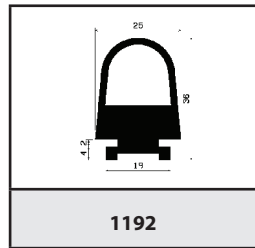

1192

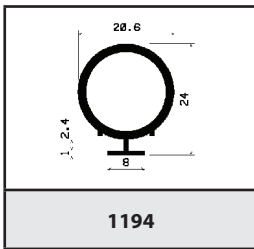

1194

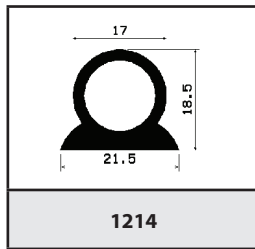

1214

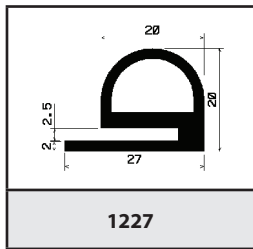

1227

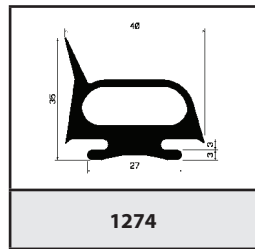

1274

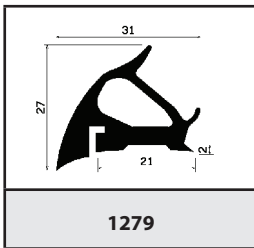

1279

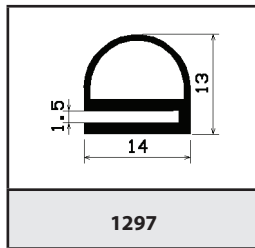

1297

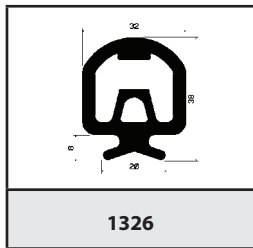

1326

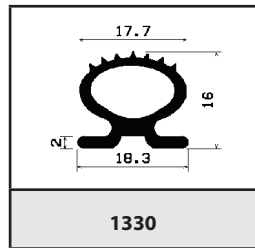

1330

○ Mikroporös-, mikroporös-/silikon-      ● gummi-, silikon-

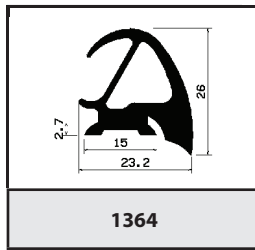

1364

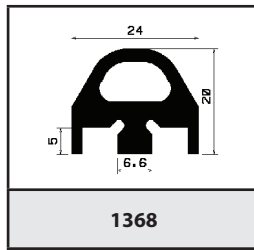

1368

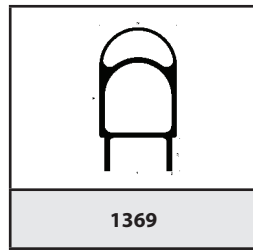

1369

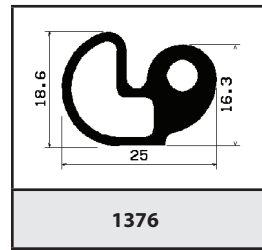

1376

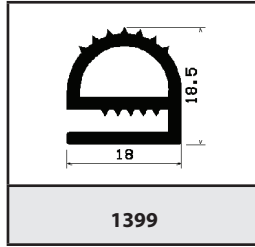

1399

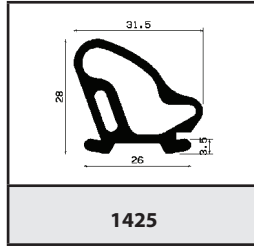

1425

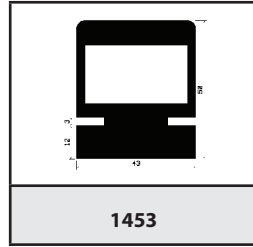

1453

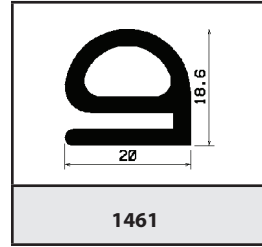

1461

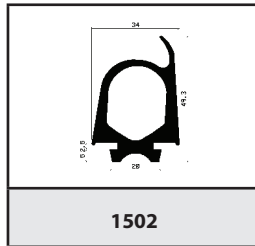

1502

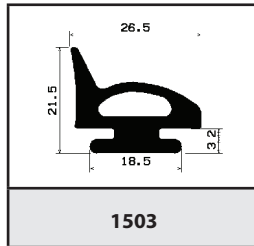

1503

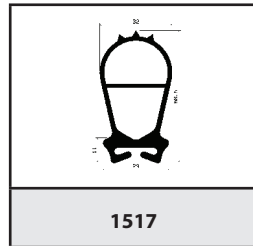

1517

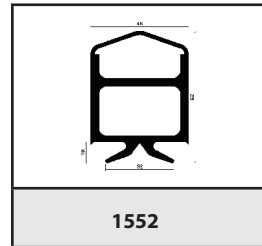

1552

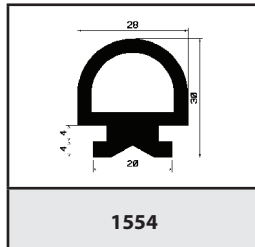

1554

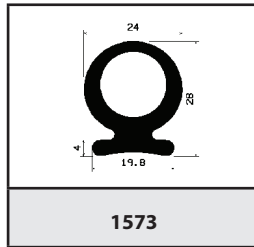

1573

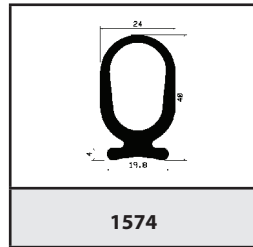

1574

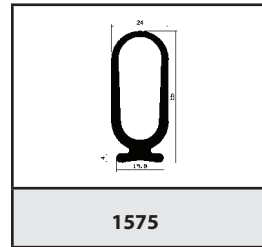

1575

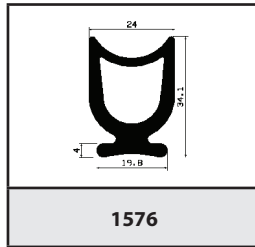

1576

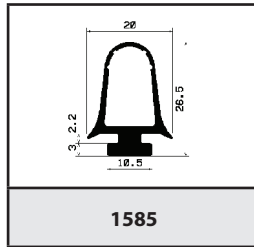

1585

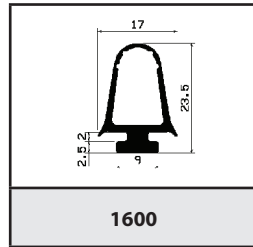

1600

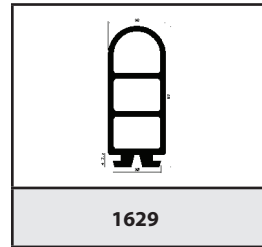

1629

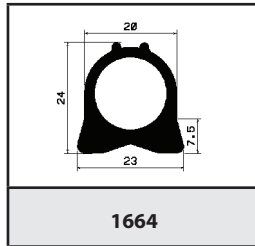

1664

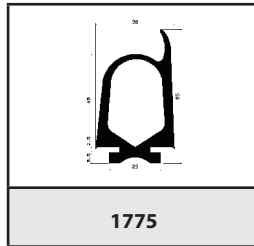

1775

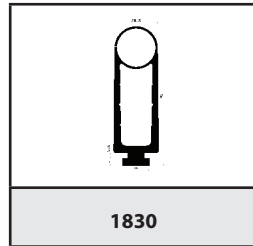

1830

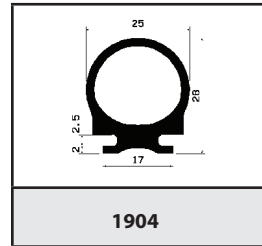

1904

○ Mikroporös-, mikroporös-/silikon- ● gummi-, silikon-

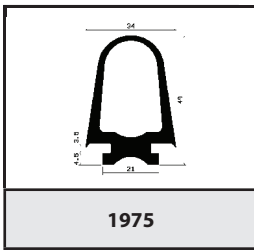

1975

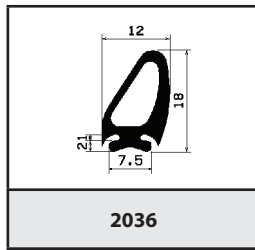

2036

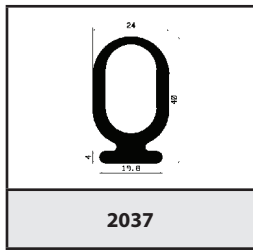

2037

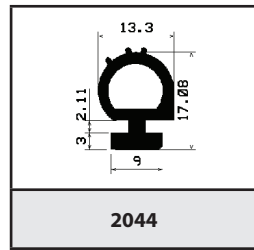

2044

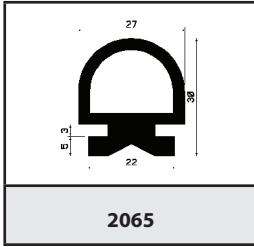

2065

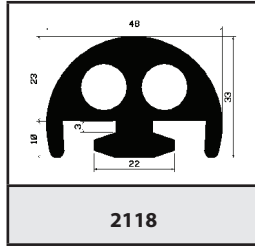

2118

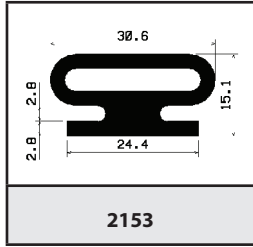

2153

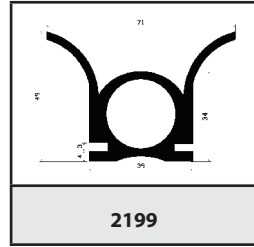

2199

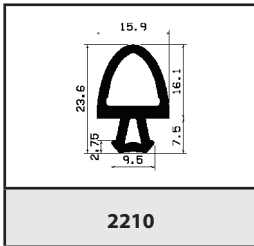

2210

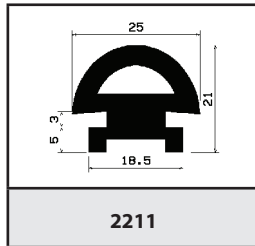

2211

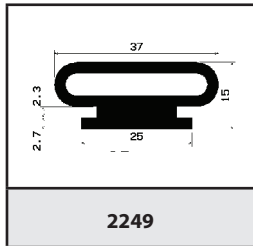

2249

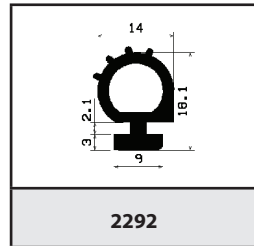

2292

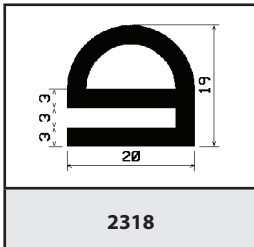

2318

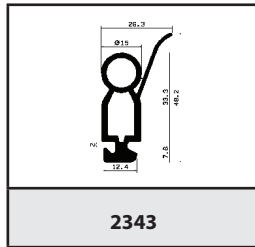

2343

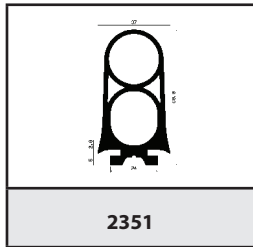

2351

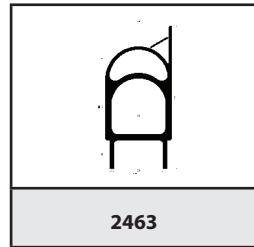

2463

○ Mikroporös-, mikroporös-/silikon- ● gummi-, silikon-



gummi (EPDM, CR, NBR, NR)	mikroporös (EPDM, CR)	Silikon		silikon mikroporös
Ř 01,00mm	Ř 01,00mm	Ř 00,60mm	Ř 12,00mm	Ř 01,00mm
Ř 01,50mm	Ř 01,50mm	Ř 01,00mm	Ř 12,50mm	Ř 01,50mm
Ř 01,55mm	Ř 02,00mm	Ř 01,50mm	Ř 13,00mm	Ř 02,00mm
Ř 01,60mm	Ř 02,50mm	Ř 01,55mm	Ř 13,50mm	Ř 02,50mm
Ř 01,78mm	Ř 02,80mm	Ř 01,60mm	Ř 14,00mm	Ř 03,00mm
Ř 02,00mm	Ř 03,00mm	Ř 01,78mm	Ř 14,50mm	Ř 03,50mm
Ř 02,50mm	Ř 03,50mm	Ř 01,80mm	Ř 15,00mm	Ř 04,00mm
Ř 02,62mm	Ř 04,00mm	Ř 02,00mm	Ř 15,50mm	Ř 04,50mm
Ř 03,00mm	Ř 04,50mm	Ř 02,40mm	Ř 16,00mm	Ř 05,00mm
Ř 03,20mm	Ř 05,00mm	Ř 02,50mm	Ř 16,50mm	Ř 05,50mm
Ř 03,50mm	Ř 05,80mm	Ř 02,62mm	Ř 17,00mm	Ř 06,00mm
Ř 04,00mm	Ř 06,00mm	Ř 03,00mm	Ř 17,50mm	Ř 06,50mm
Ř 04,50mm	Ř 06,50mm	Ř 03,20mm	Ř 18,00mm	Ř 07,00mm
Ř 05,00mm	Ř 07,00mm	Ř 03,35mm	Ř 18,50mm	Ř 08,00mm
Ř 05,33mm	Ř 07,50mm	Ř 03,50mm	Ř 19,00mm	Ř 12,00mm
Ř 05,50mm	Ř 08,00mm	Ř 04,00mm	Ř 19,50mm	Ř 15,00mm
Ř 05,70mm	Ř 09,60mm	Ř 04,50mm	Ř 20,00mm	Ř 18,00mm
Ř 06,00mm	Ř 10,00mm	Ř 05,00mm	Ř 20,50mm	Ř 20,00mm
Ř 06,50mm	Ř 11,00mm	Ř 05,33mm	Ř 21,00mm	Ř 22,00mm
Ř 06,60mm	Ř 12,00mm	Ř 05,50mm	Ř 21,50mm	Ř 25,00mm
Ř 07,00mm	Ř 13,00mm	Ř 05,70mm	Ř 22,00mm	Ř 30,00mm
Ř 07,50mm	Ř 13,50mm	Ř 06,00mm	Ř 22,50mm	Ř 32,00mm
Ř 08,00mm	Ř 14,00mm	Ř 06,35mm	Ř 23,00mm	Ř 35,00mm
Ř 08,50mm	Ř 15,00mm	Ř 06,50mm	Ř 23,50mm	Ř 40,00mm
Ř 09,00mm	Ř 16,00mm	Ř 07,00mm	Ř 24,00mm	Ř 43,00mm
Ř 10,00mm	Ř 16,50mm	Ř 07,50mm	Ř 24,50mm	Ř 45,00mm
Ř 11,00mm	Ř 17,00mm	Ř 08,00mm	Ř 25,00mm	Ř 50,00mm
Ř 12,00mm	Ř 18,00mm	Ř 08,50mm	Ř 30,00mm	Ř 60,00mm
Ř 13,00mm	Ř 19,00mm	Ř 09,00mm	Ř 30,00mm	
Ř 14,00mm	Ř 20,00mm	Ř 09,50mm	Ř 35,00mm	
Ř 15,00mm	Ř 22,00mm	Ř 10,00mm	Ř 38,00mm	
Ř 16,00mm	Ř 23,00mm	Ř 10,50mm	Ř 40,00mm	
Ř 17,00mm	Ř 25,00mm	Ř 11,00mm	Ř 45,00mm	
Ř 18,00mm	Ř 28,00mm	Ř 11,50mm	Ř 50,00mm	
Ř 19,00mm	Ř 30,00mm			
Ř 20,00mm	Ř 33,00mm			
Ř 22,00mm	Ř 35,00mm			
Ř 24,00mm	Ř 38,00mm			
Ř 25,00mm	Ř 40,00mm			
Ř 27,50mm	Ř 45,00mm			
Ř 30,00mm	Ř 48,00mm			
Ř 33,00mm	Ř 50,00mm			
Ř 35,00mm	Ř 52,50mm			
Ř 37,00mm	Ř 60,00mm			
Ř 40,00mm				
Ř 45,00mm				
Ř 50,00mm				

Die angegebenen Abmessungen sind in allen aufgeführten Materialien lieferbar.

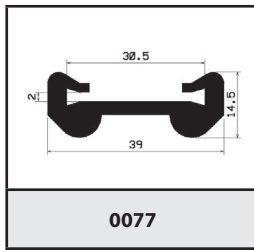

0077

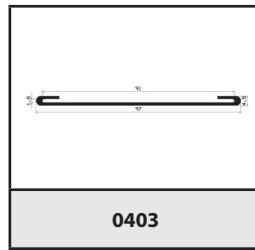

0403

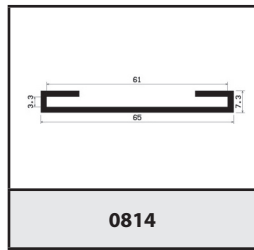

0814

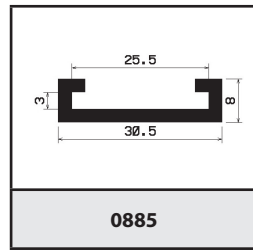

0885

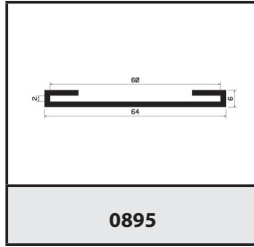

0895

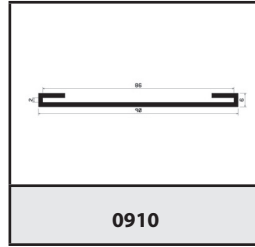

0910

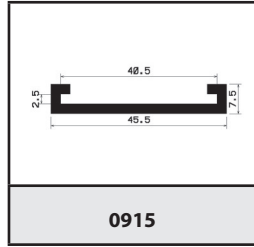

0915

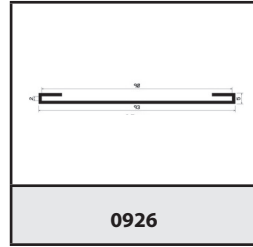

0926

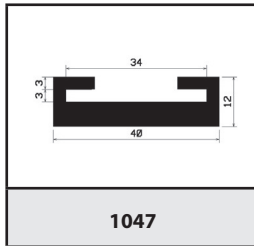

1047

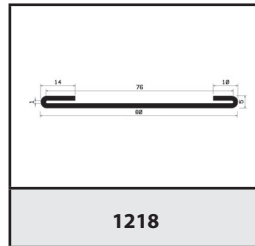

1218

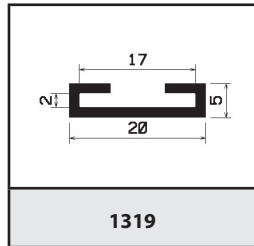

1319

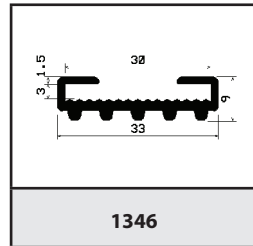

1346

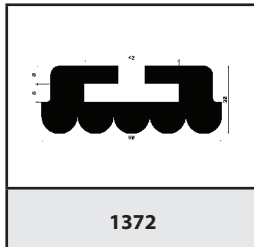

1372

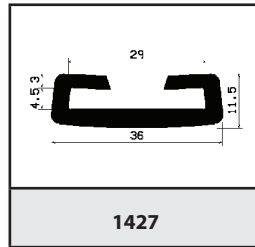

1427

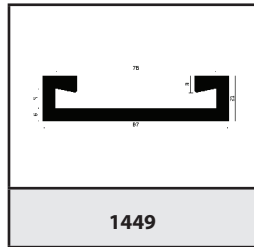

1449

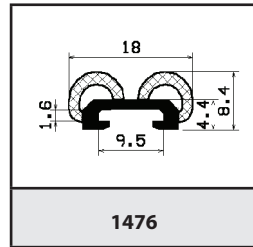

1476

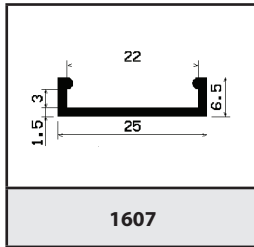

1607

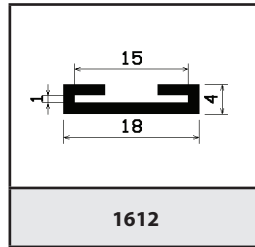

1612

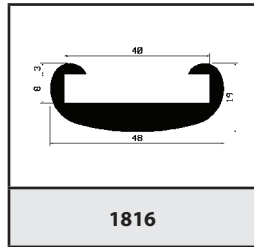

1816

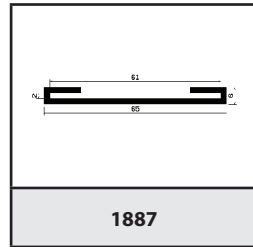

1887

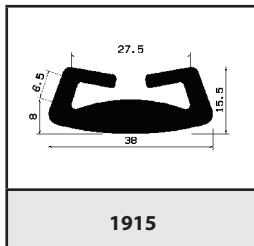

1915

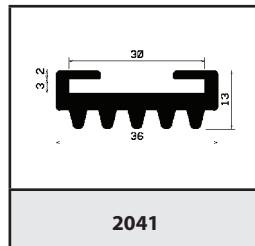

2041

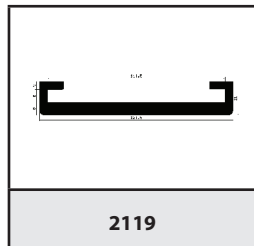

2119

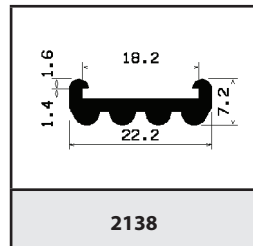

2138

○ Mikroporös-, mikroporös-/silikon- ● gummi-, silikon-

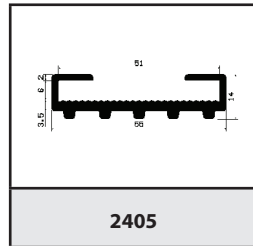
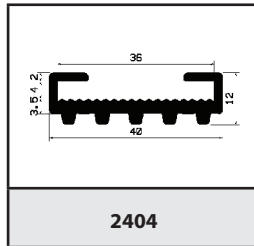
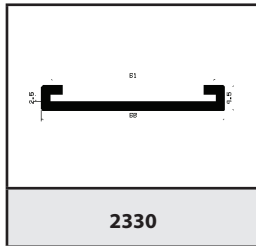
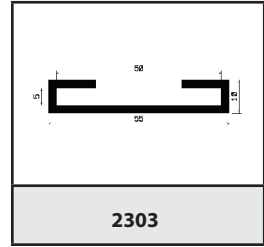
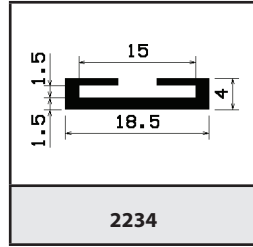
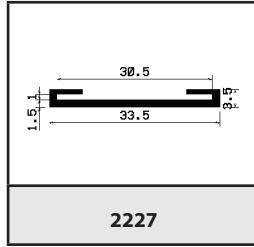
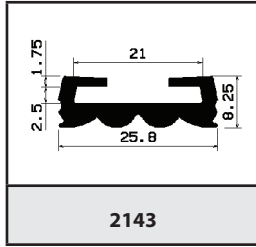
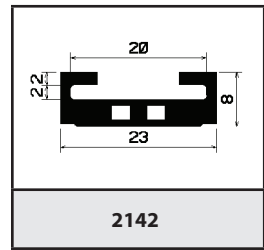
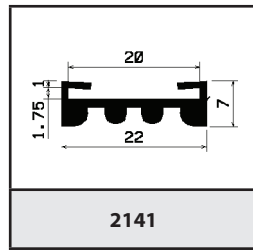
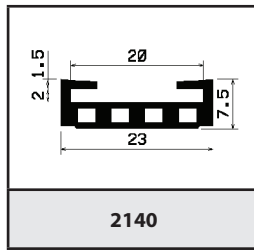
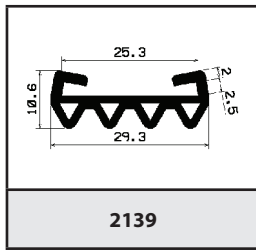

○ Mikroporös-, mikroporös-/silikon-      ● gummi-, silikon-

(EPDM, CR, NBR, NR) gummi	(EPDM, CR) mikroporös	Silikon		silikon mikroporös
		Innen / Außendurchmesser		
∅ 02,00/05,00mm	∅ 05,00/14,00mm	∅ 01,00/03,00 mm	∅ 10,00/12,00 mm	∅ 06,00/10,00mm
∅ 03,00/05,00mm	∅ 05,90/20,00mm	∅ 02,00/04,00 mm	∅ 10,00/14,00 mm	∅ 07,00/19,00mm
∅ 03,00/06,00mm	∅ 06,00/15,00mm	∅ 03,00/04,00 mm	∅ 10,00/15,00 mm	∅ 12,00/17,00mm
∅ 04,00/06,00mm	∅ 07,80/16,00mm	∅ 03,00/05,00 mm	∅ 10,00/19,00 mm	∅ 12,00/24,00mm
∅ 04,00/07,00mm	∅ 08,00/13,00mm	∅ 03,00/08,00 mm	∅ 10,00/22,00 mm	∅ 13,00/31,00mm
∅ 04,00/07,00mm	∅ 08,00/14,00mm	∅ 03,00/08,50mm	∅ 12,00/16,00 mm	∅ 20,00/34,00mm
∅ 04,00/08,00mm	∅ 08,00/16,00mm	∅ 03,00/09,00 mm	∅ 12,00/20,00 mm	∅ 20,00/40,00mm
∅ 05,00/07,00mm	∅ 08,00/18,00mm	∅ 03,50/04,30mm	∅ 13,00/17,00 mm	∅ 20,00/60,00mm
∅ 05,00/08,00mm	∅ 09,00/19,50mm	∅ 04,00/05,00 mm	∅ 13,00/18,00 mm	∅ 21,00/35,00mm
∅ 05,60/08,00mm	∅ 09,00/28,00mm	∅ 04,00/06,00 mm	∅ 13,00/19,00 mm	∅ 21,00/39,00mm
∅ 06,00/09,00mm	∅ 09,00/30,00mm	∅ 04,00/07,00 mm	∅ 14,00/18,00 mm	∅ 25,00/45,00mm
∅ 06,00/10,00mm	∅ 09,50/13,50m	∅ 04,00/07,20mm	∅ 14,00/22,00 mm	∅ 30,00/50,00mm
∅ 06,00/12,00mm	∅ 09,50/20,00mm	∅ 04,00/08,00 mm	∅ 14,00/44,00 mm	∅ 40,00/60,00mm
∅ 07,00/25,00mm	∅ 10,00/14,00mm	∅ 05,00/08,00 mm	∅ 15,00/19,00 mm	
∅ 08,00/11,00mm	∅ 10,00/15,00mm	∅ 06,00/09,00 mm	∅ 16,00/22,00 mm	
∅ 08,00/12,00mm	∅ 10,00/20,00mm	∅ 06,00/10,00 mm	∅ 17,00/20,00 mm	
∅ 08,00/15,00mm	∅ 10,00/25,00mm	∅ 06,00/12,00 mm	∅ 18,00/22,00 mm	
∅ 09,00/12,00mm	∅ 10,00/32,00mm	∅ 06,00/25,00 mm	∅ 20,00/60,00mm	
∅ 10,00/14,00mm	∅ 12,00/26,00mm	∅ 07,00/08,00 mm	∅ 24,00/28,00 mm	
∅ 10,00/32,00mm	∅ 12,00/28,00mm	∅ 07,00/10,00 mm	∅ 25,00/31,00 mm	
∅ 12,00/02,20mm	∅ 12,00/30,00mm	∅ 08,00/10,00 mm	∅ 25,00/52,00 mm	
∅ 12,00/15,00mm	∅ 14,00/20,00mm	∅ 08,00/12,00 mm	∅ 26,00/30,00 mm	
∅ 12,00/16,00mm	∅ 14,00/24,00mm	∅ 08,00/14,00 mm	∅ 30,00/44,00 mm	
∅ 12,00/17,00mm	∅ 15,00/25,00mm	∅ 09,00/13,00 mm	∅ 40,00/43,00 mm	
∅ 14,00/26,00mm	∅ 15,00/35,00mm	∅ 50,00/56,00 mm	∅ 40,00/46,00 mm	
∅ 16,00/19,00mm	∅ 15,00/36,00mm	∅ 55,00/60,00 mm	∅ 40,00/50,00 mm	
∅ 20,00/23,00mm	∅ 16,00/25,00mm	∅ 80,00/84,00 mm	∅ 44,00/54,00 mm	
∅ 20,00/24,00mm	∅ 16,00/26,00mm			
∅ 22,00/27,00mm	∅ 16,00/30,00mm			
∅ 24,00/28,00mm	∅ 16,00/36,00mm			
∅ 28,00/32,00mm	∅ 18,00/25,00mm			
∅ 28,00/40,00mm	∅ 18,00/26,00mm			
	∅ 18,00/35,00mm			
	∅ 19,00/25,00mm			
	∅ 19,00/30,00mm			
	∅ 20,00/50,00mm			
	∅ 22,00/30,00mm			
	∅ 22,00/48,00mm			
	∅ 23,00/34,00mm			
	∅ 28,00/46,00mm			

Die angegebenen Abmessungen sind in allen aufgeführten Materialien lieferbar.

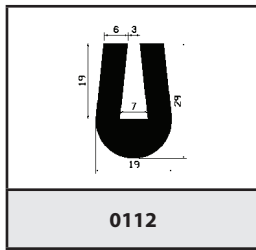

0112

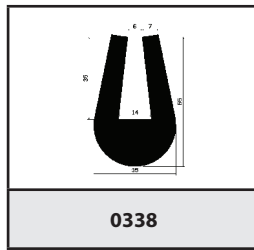

0338

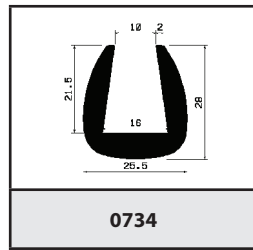

0734

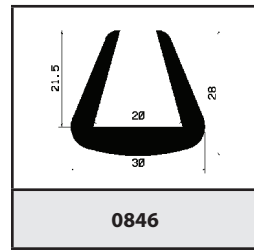

0846

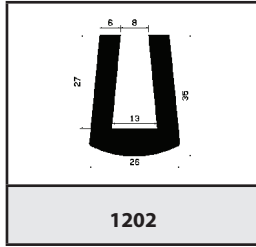

1202

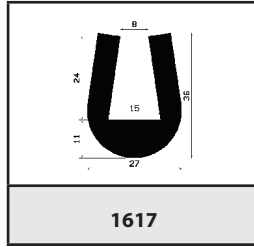

1617

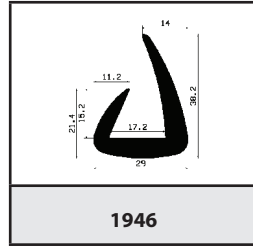

1946

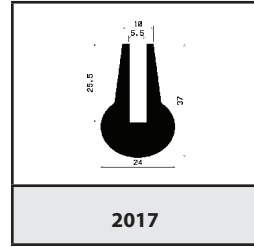

2017

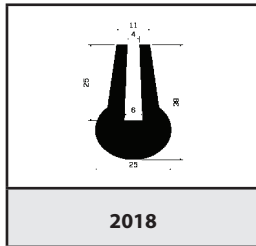

2018

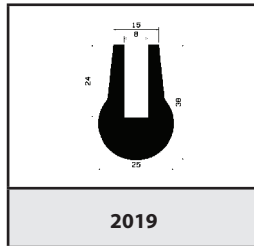

2019

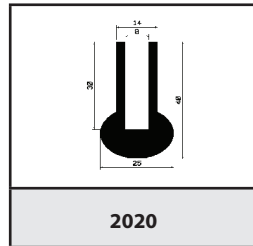

2020

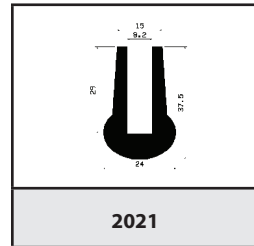

2021

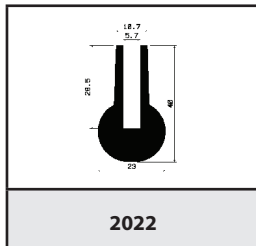

2022

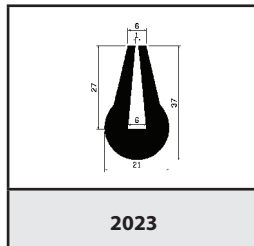

2023

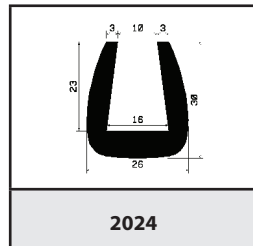

2024

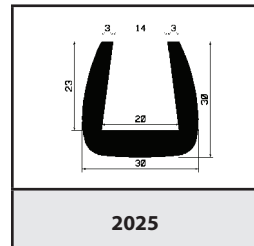

2025

○ Mikroporös-, mikroporös-/silikon-      ● gummi-, silikon-

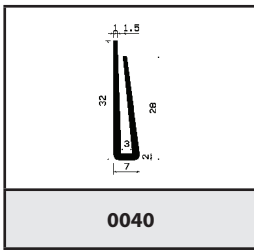

0040

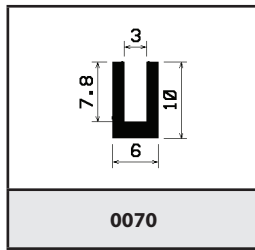

0070

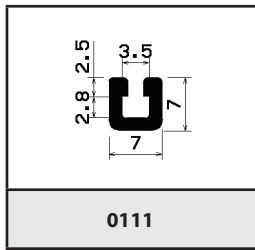

0111

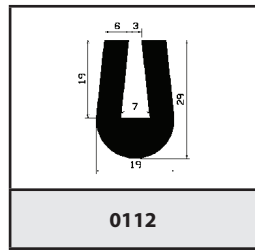

0112

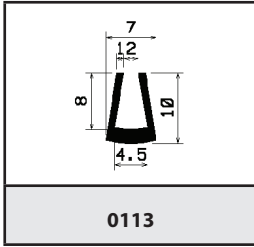

0113

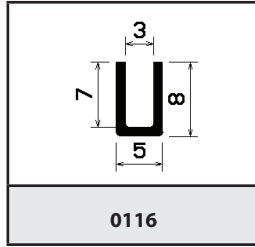

0116

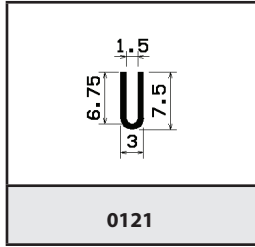

0121

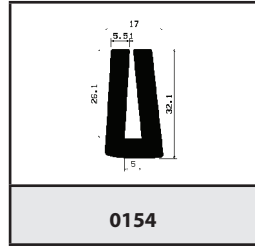

0154

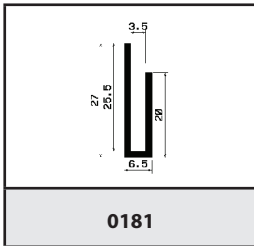

0181

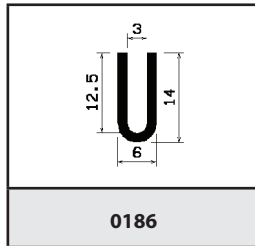

0186

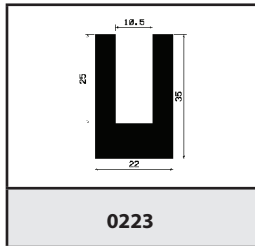

0223

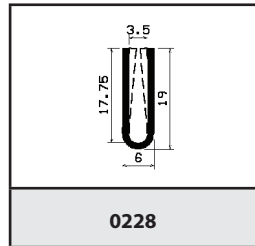

0228

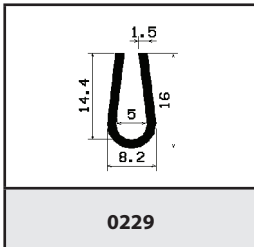

0229

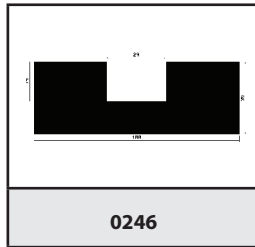

0246

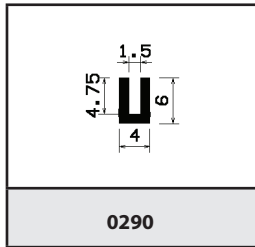

0290

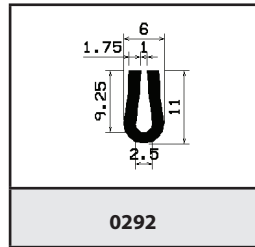

0292

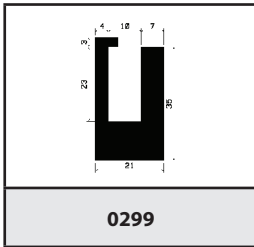

0299

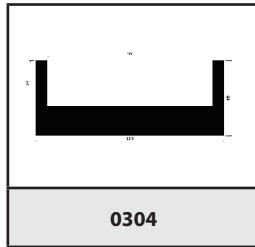

0304

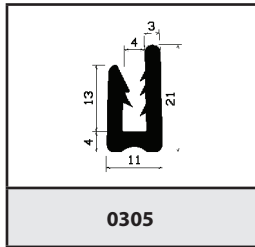

0305

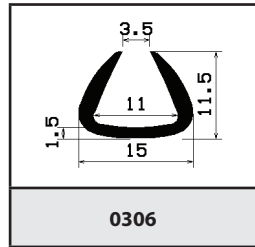

0306

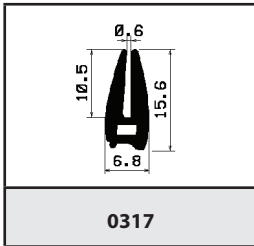

0317

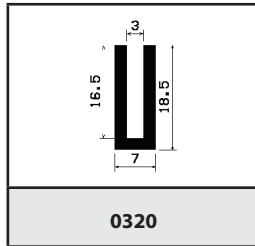

0320

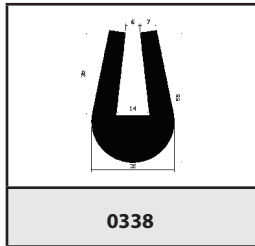

0338

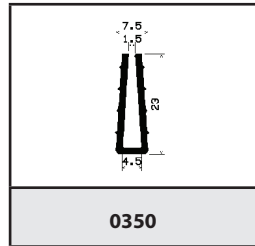

0350

○ Mikroporös-, mikroporös-/silikon-      ● gummi-, silikon-

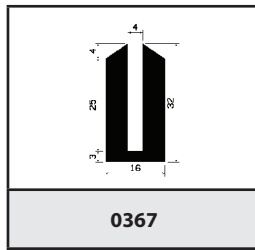

0367

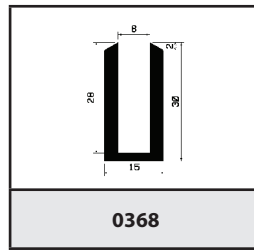

0368

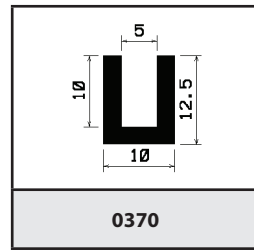

0370

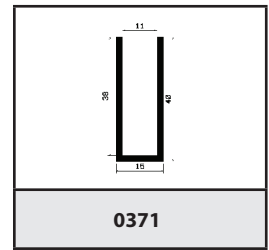

0371

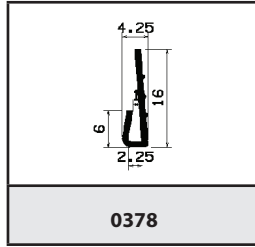

0378

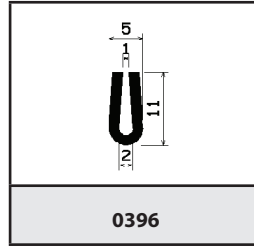

0396

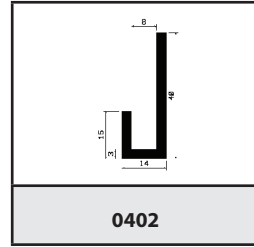

0402

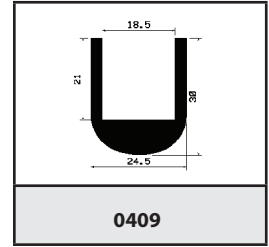

0409

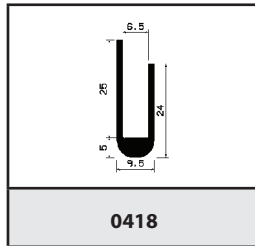

0418

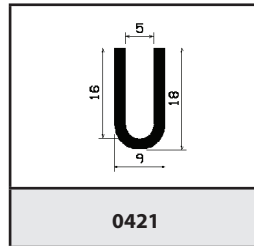

0421

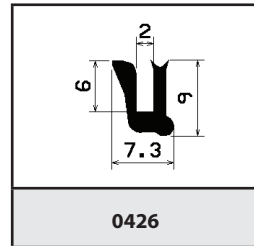

0426

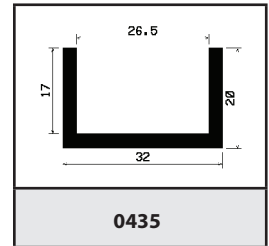

0435

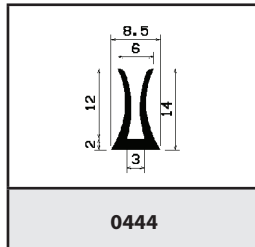

0444

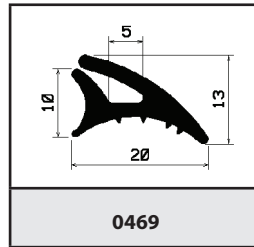

0469

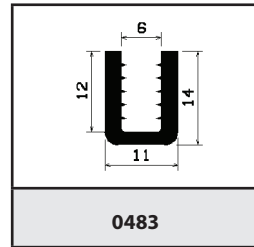

0483

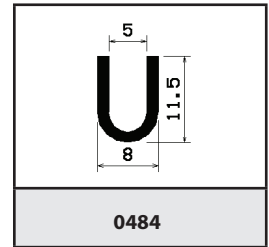

0484

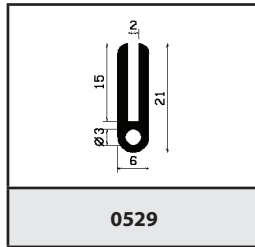

0529

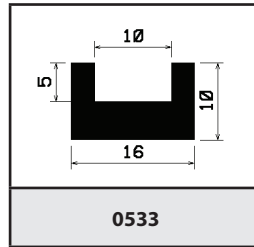

0533

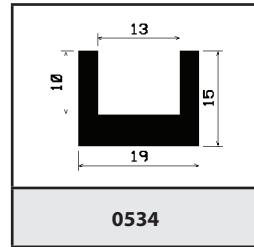

0534

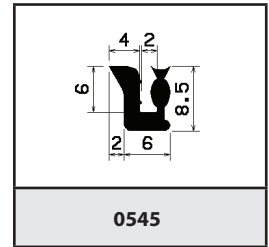

0545

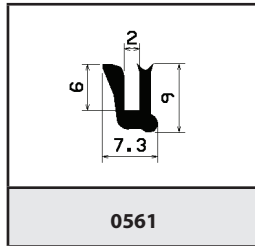

0561

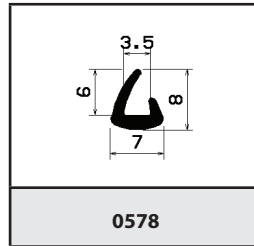

0578

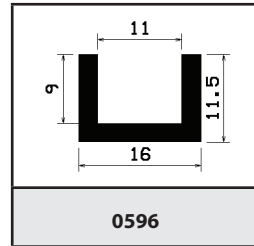

0596

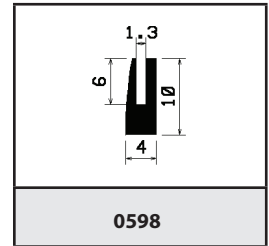

0598

○ Mikroporös-, mikroporös-/silikon- ● gummi-, silikon-

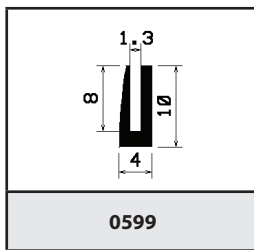

0599

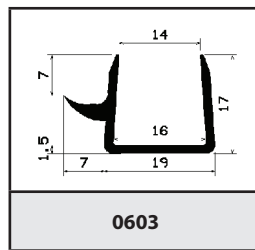

0603

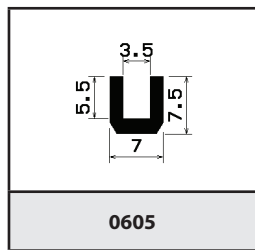

0605

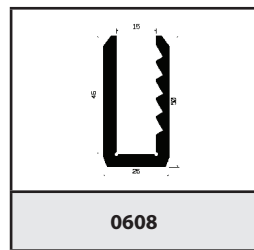

0608

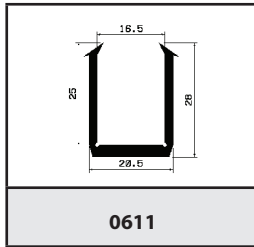

0611

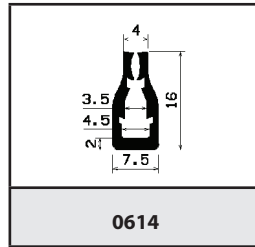

0614

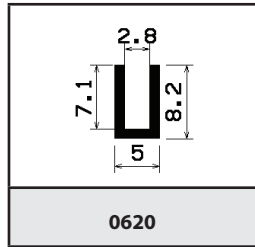

0620

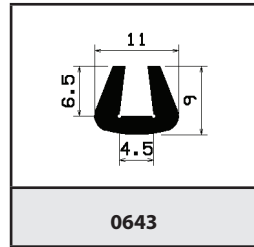

0643

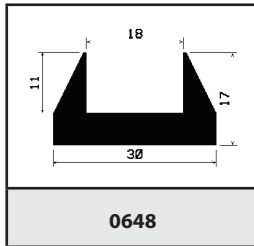

0648

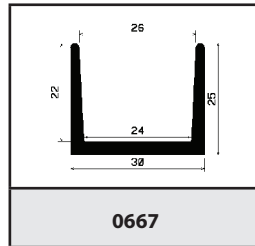

0667

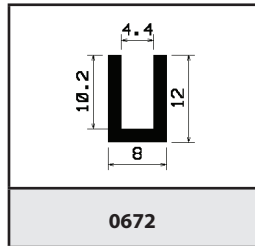

0672

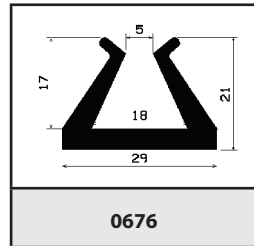

0676

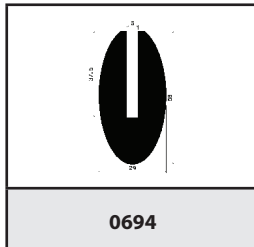

0694

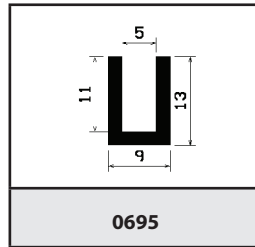

0695

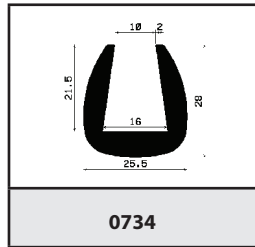

0734

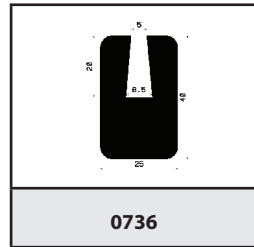

0736

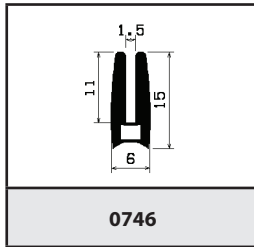

0746

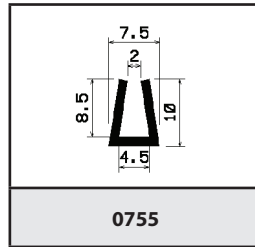

0755

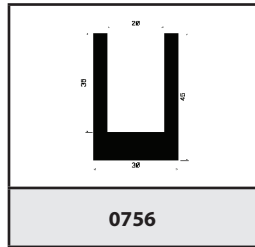

0756

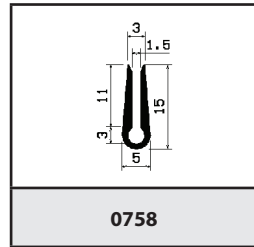

0758

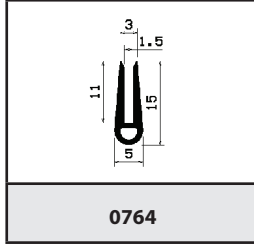

0764

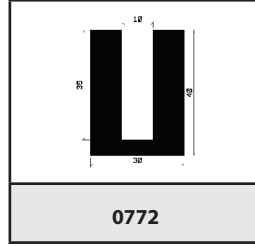

0772

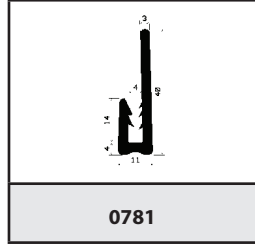

0781

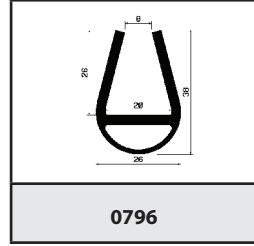

0796

○ Mikroporös-, mikroporös-/silikon-      ● gummi-, silikon-



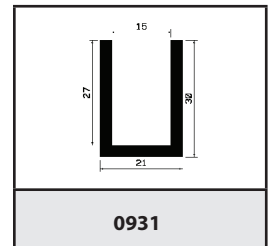
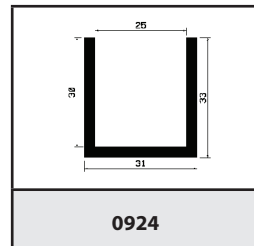
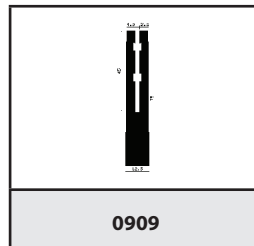
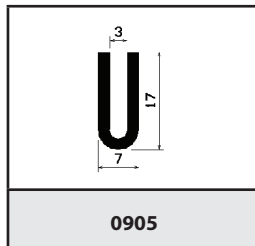
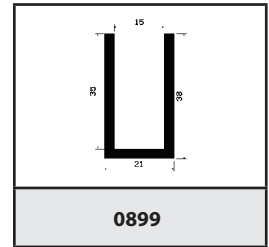
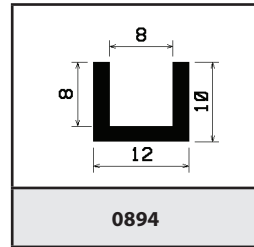
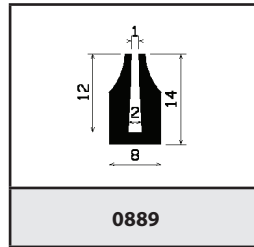
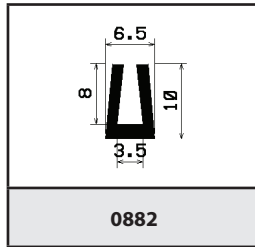
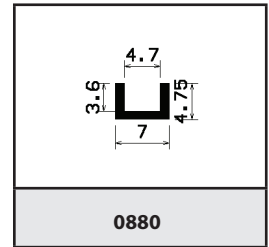
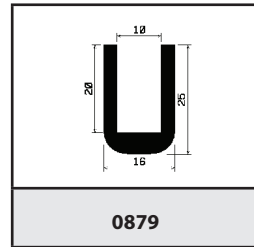
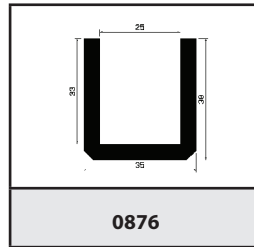
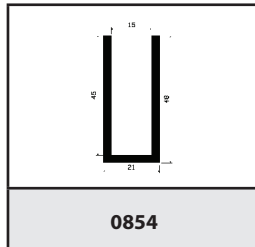
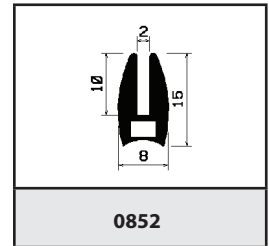
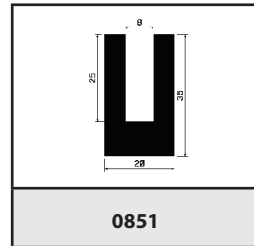
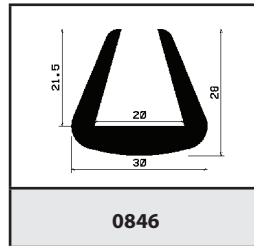
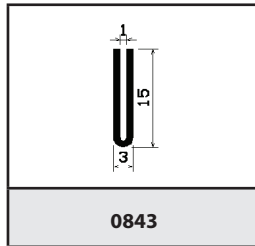
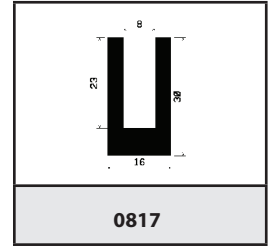
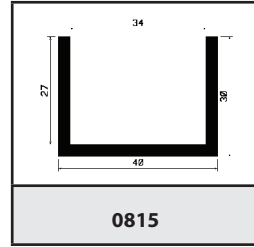
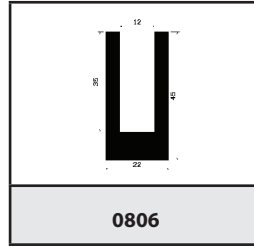
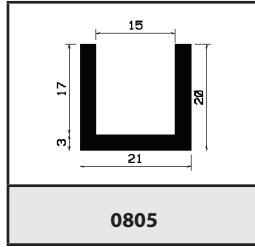
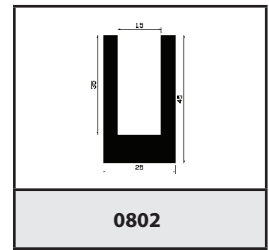
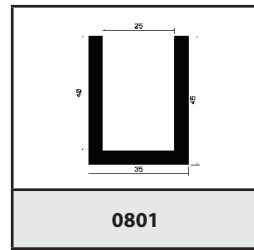
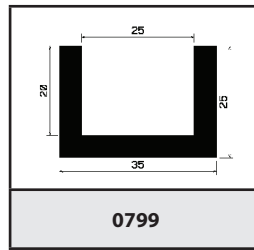
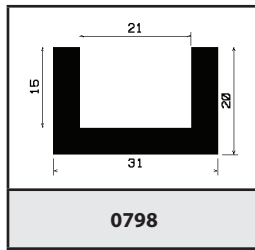

○ Mikroporös-, mikroporös-/silikon- ● gummi-, silikon-

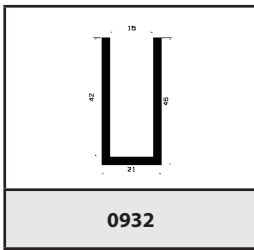

0932

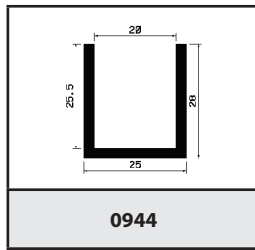

0944

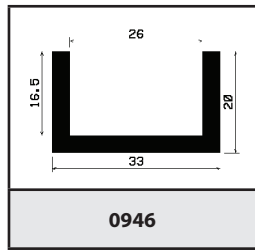

0946

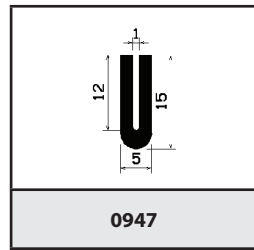

0947

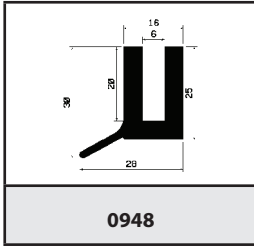

0948

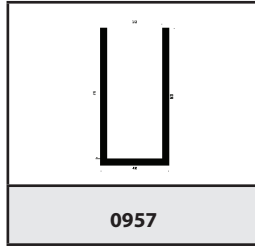

0957

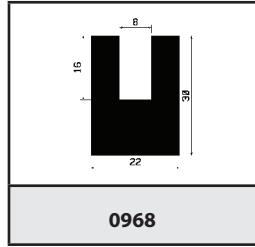

0968

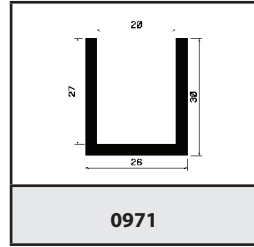

0971

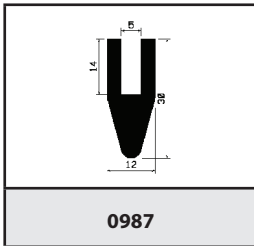

0987

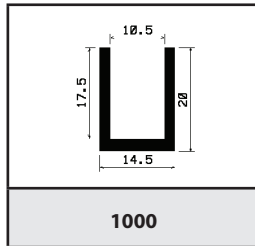

1000

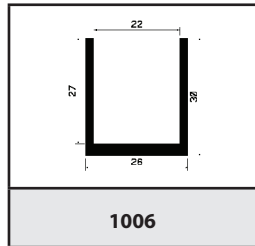

1006

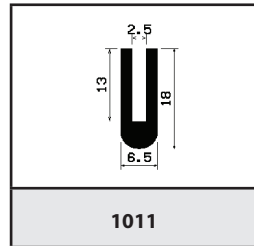

1011

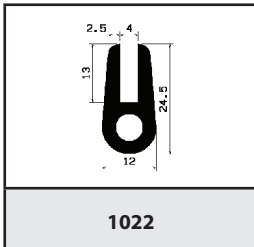

1022

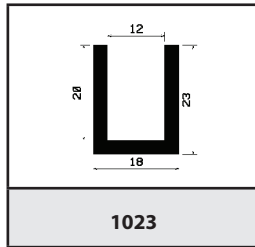

1023

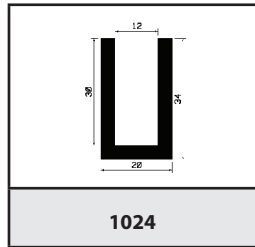

1024

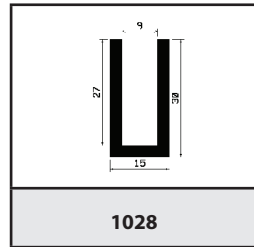

1028

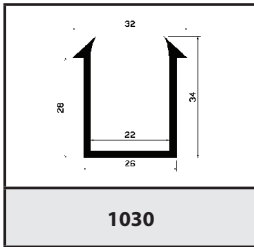

1030

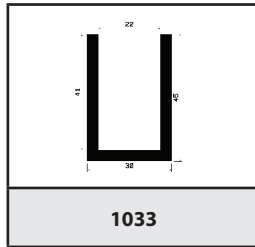

1033

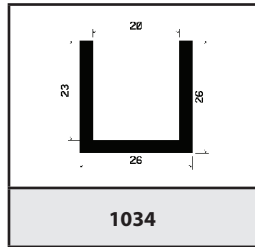

1034

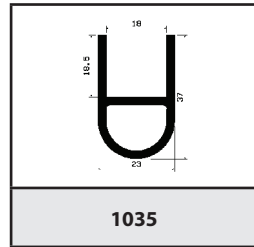

1035

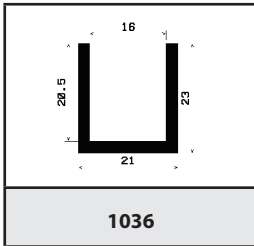

1036

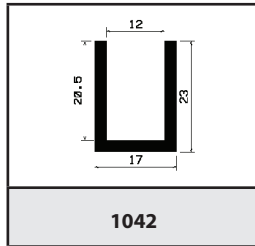

1042

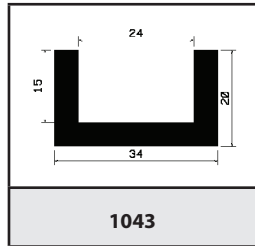

1043

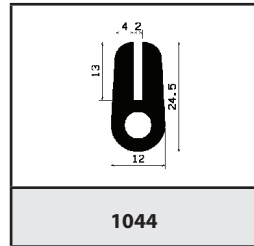

1044

○ Mikroporös-, mikroporös-/silikon- ● gummi-, silikon-

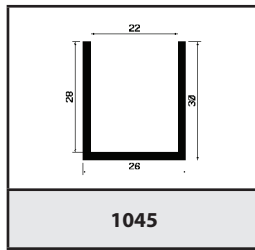

1045

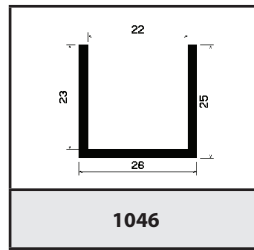

1046

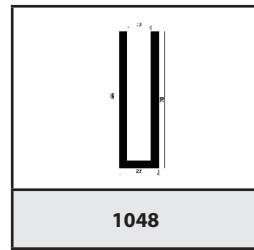

1048

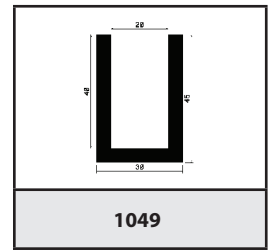

1049

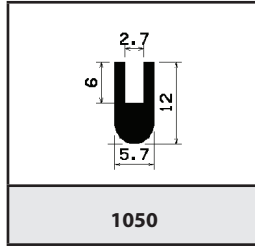

1050

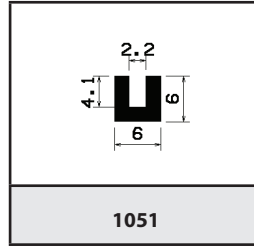

1051

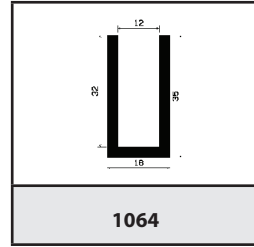

1064

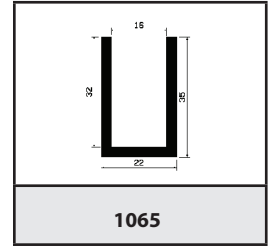

1065

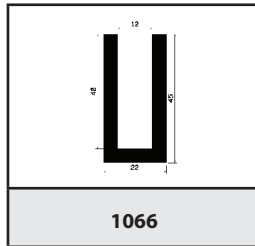

1066

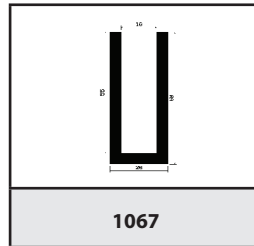

1067

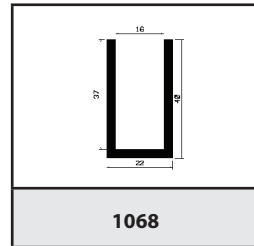

1068

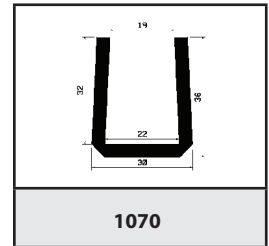

1070

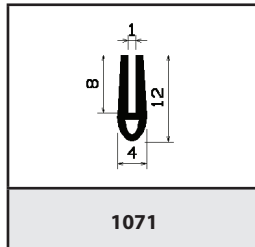

1071

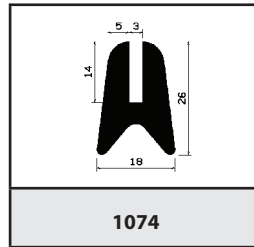

1074

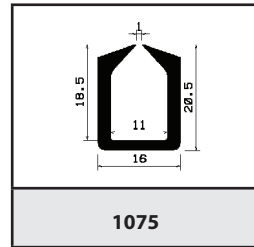

1075

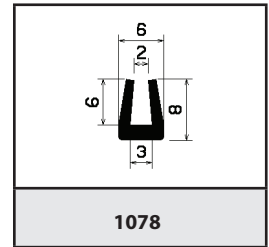

1078

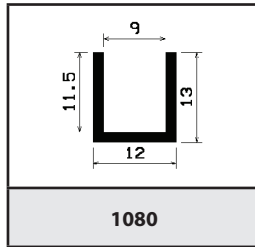

1080

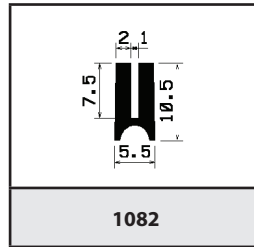

1082

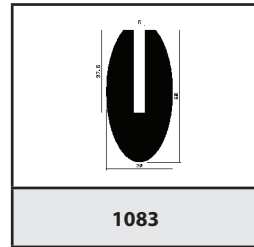

1083

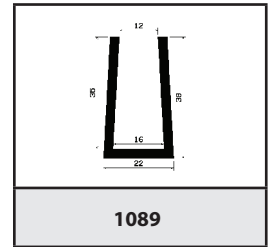

1089

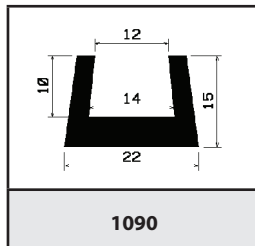

1090

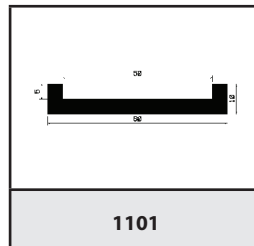

1101

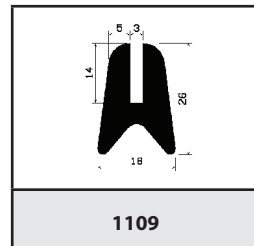

1109

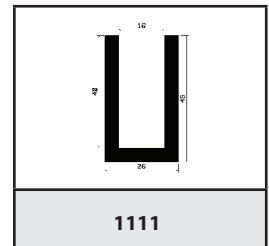

1111

○ Mikroporös-, mikroporös-/silikon-      ● gummi-, silikon-

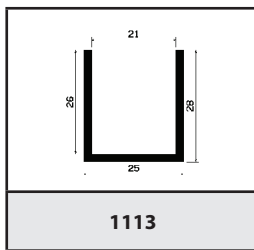

1113

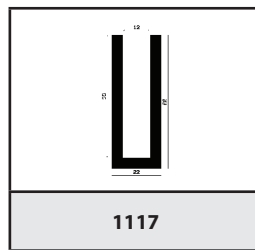

1117

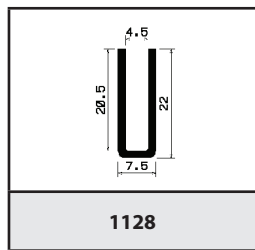

1128

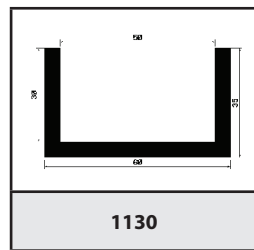

1130

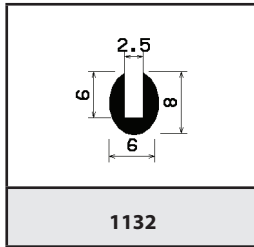

1132

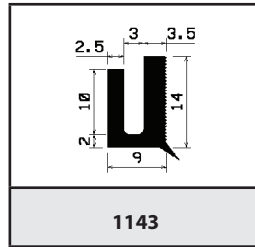

1143

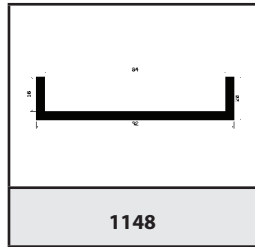

1148

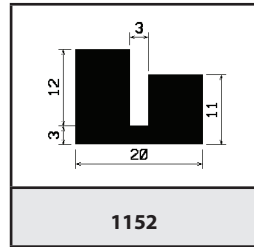

1152

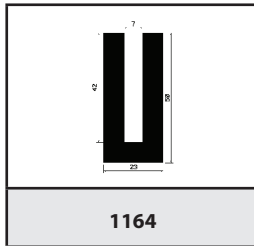

1164

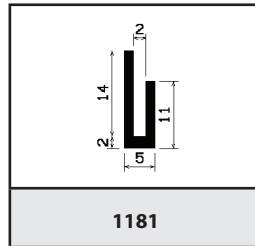

1181

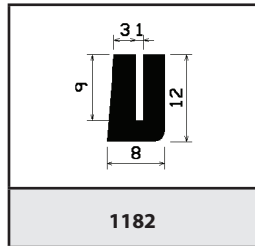

1182

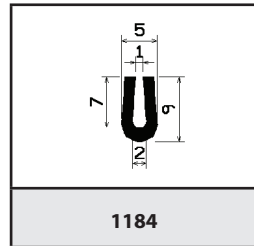

1184

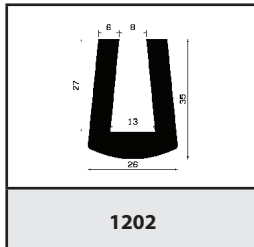

1202

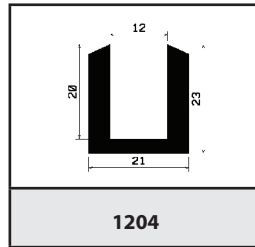

1204

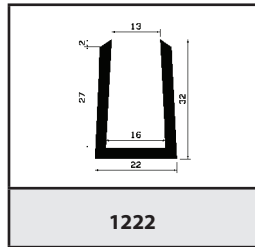

1222

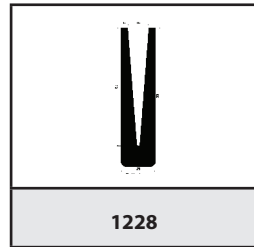

1228

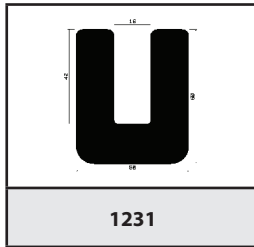

1231

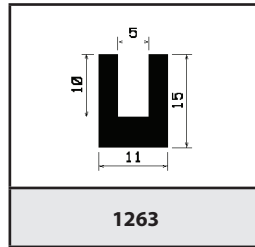

1263

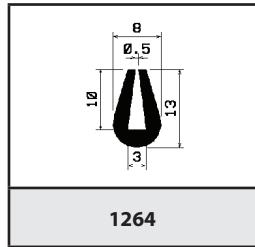

1264

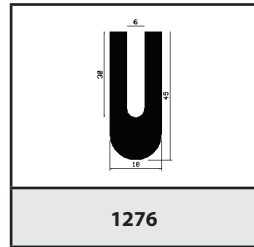

1276

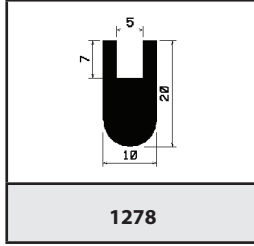

1278

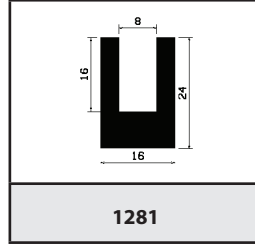

1281

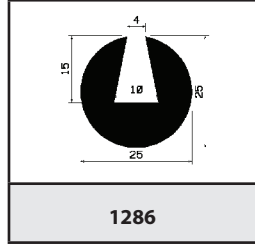

1286

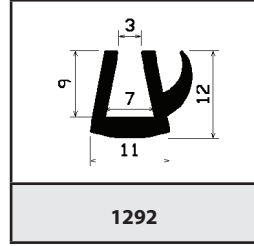

1292

○ Mikroporös-, mikroporös-/silikon-      ● gummi-, silikon-

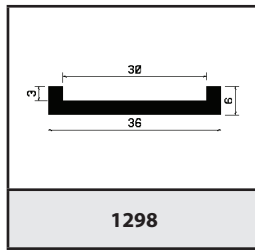

1298

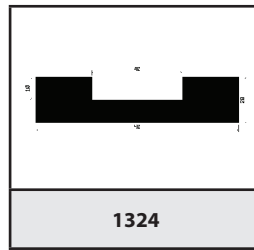

1324

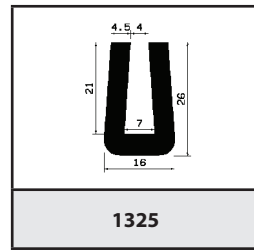

1325

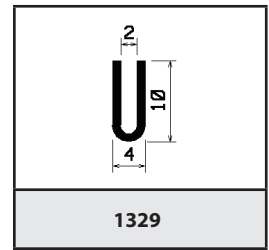

1329

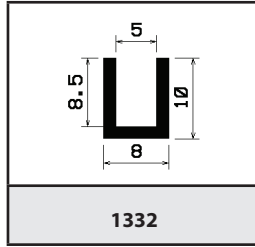

1332

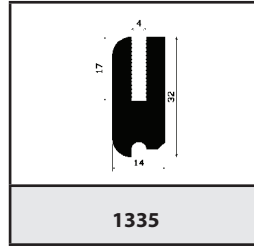

1335

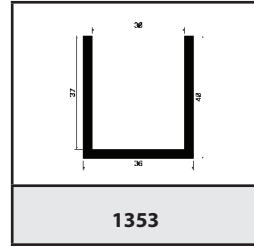

1353

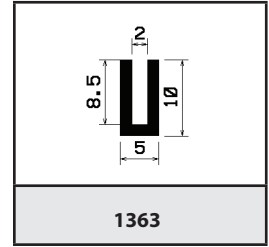

1363

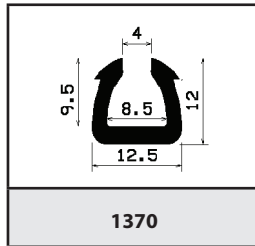

1370

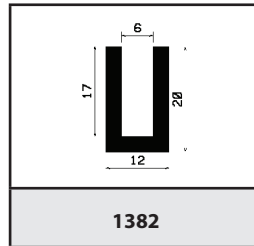

1382

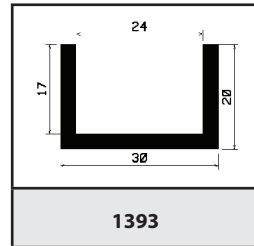

1393

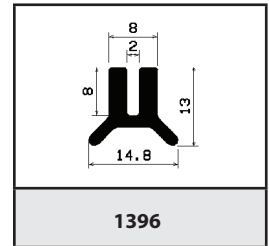

1396

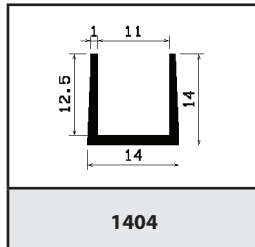

1404

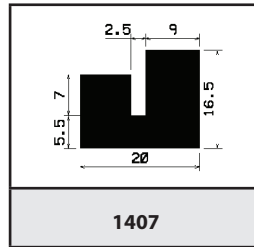

1407

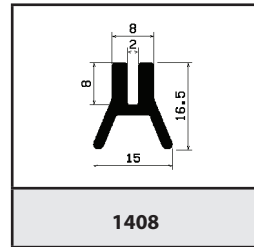

1408

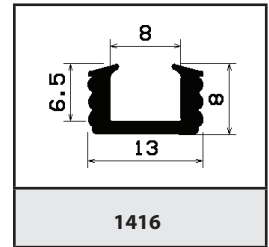

1416

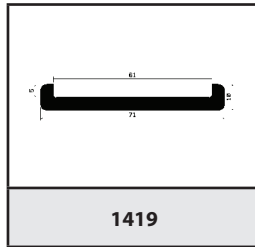

1419

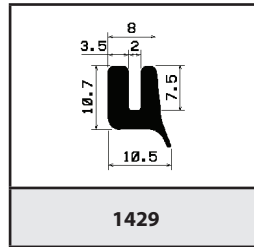

1429

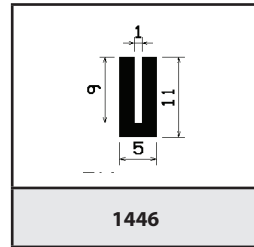

1446

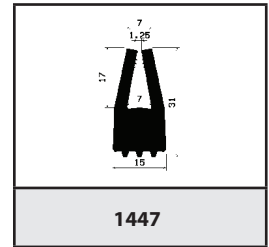

1447

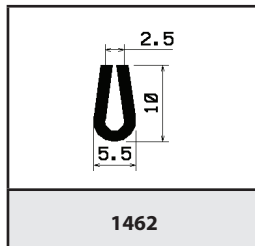

1462

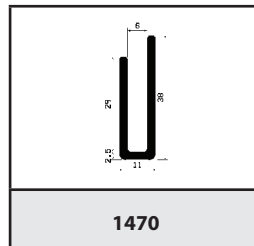

1470

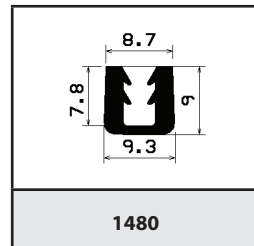

1480

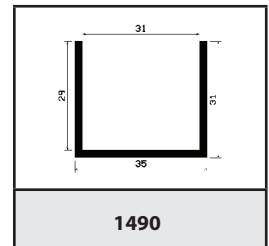

1490

○ Mikroporös-, mikroporös-/silikon-      ● gummi-, silikon-

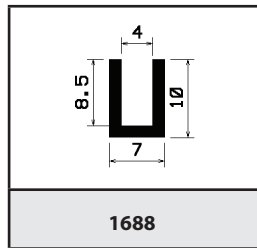
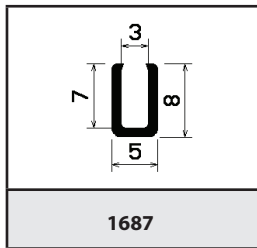
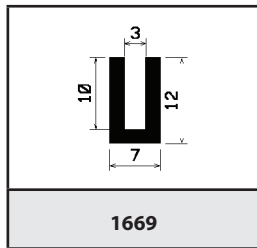
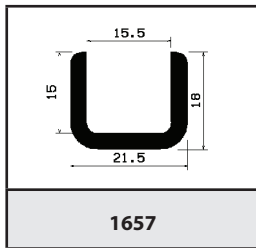
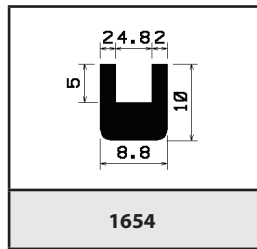
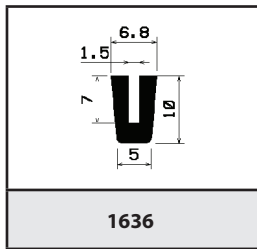
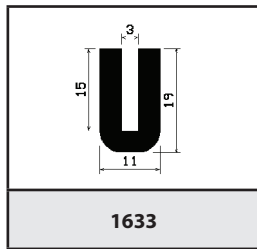
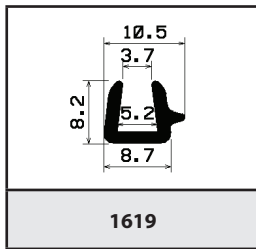
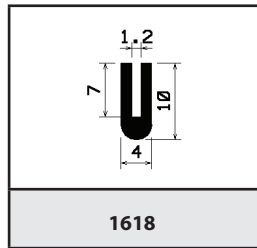
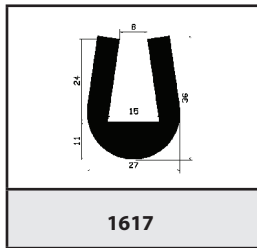
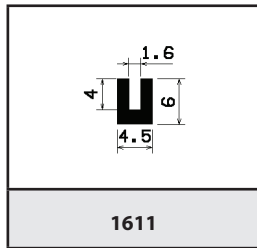
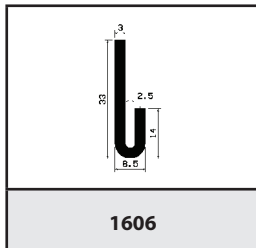
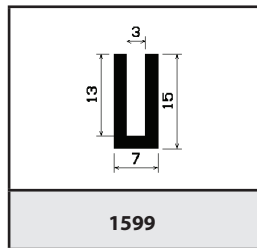
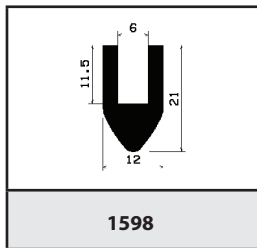
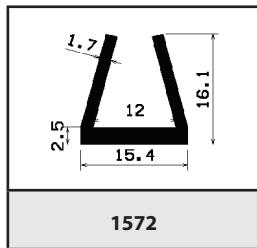
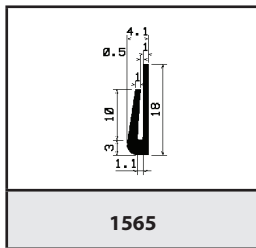
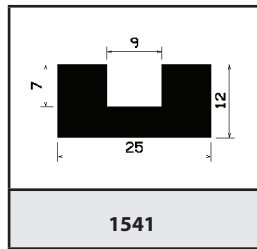
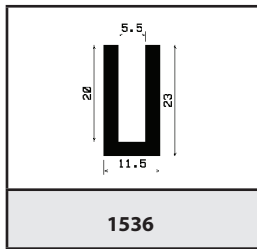
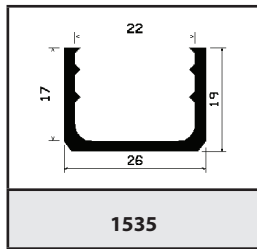
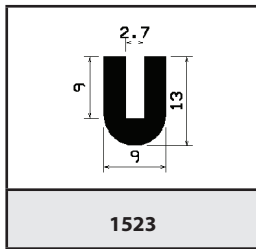
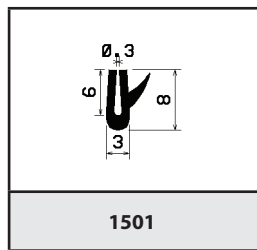
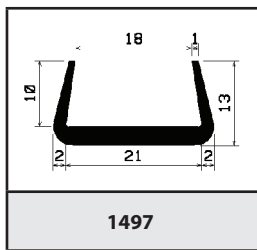
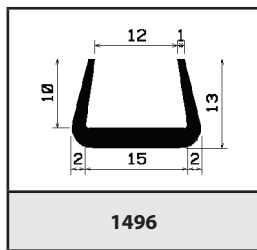
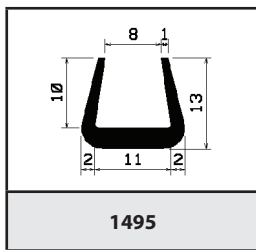

○ Mikroporös-, mikroporös-/silikon-      ● gummi-, silikon-

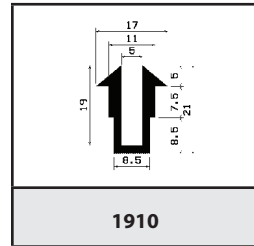
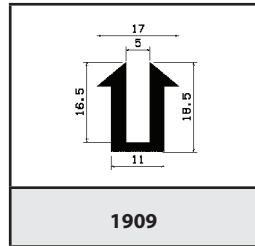
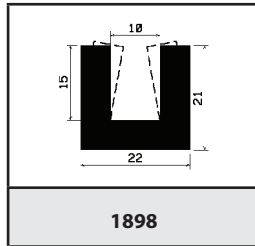
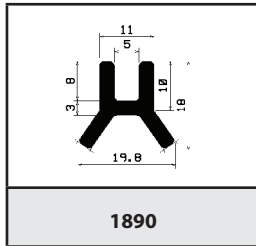
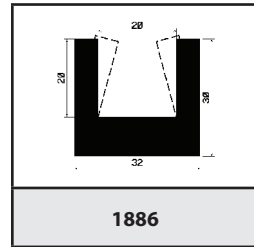
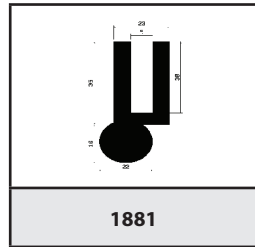
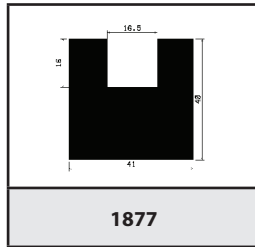
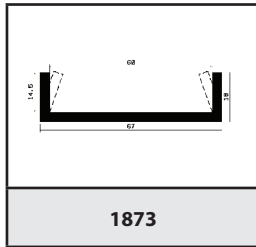
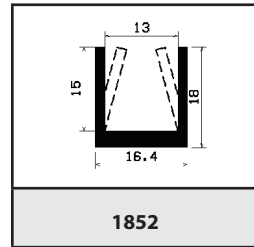
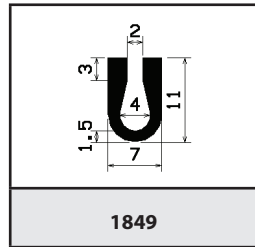
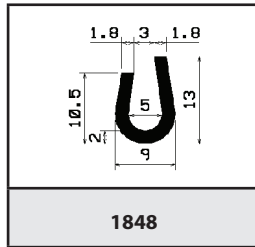
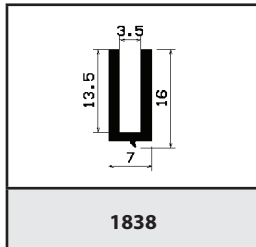
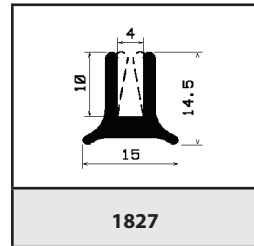
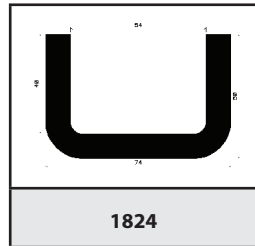
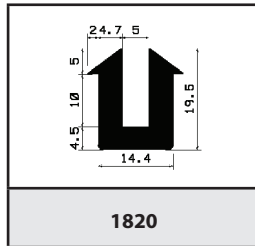
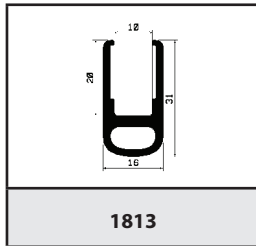
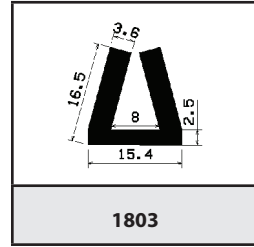
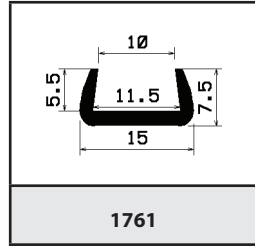
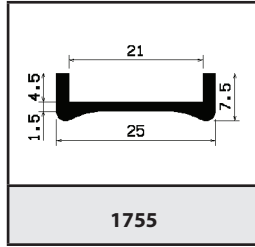
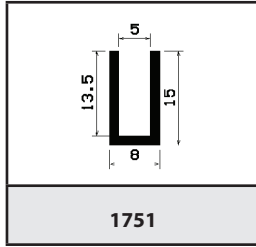
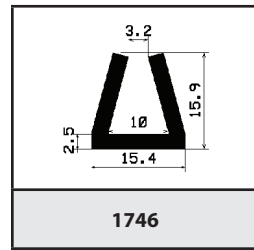
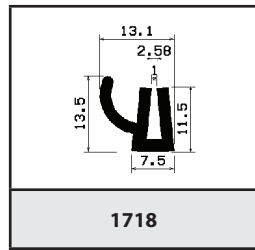
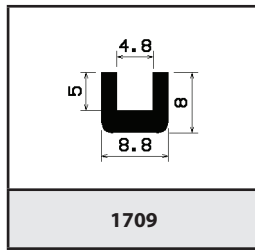
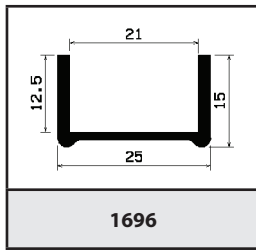

○ Mikroporös-, mikroporös-/silikon- ● gummi-, silikon-

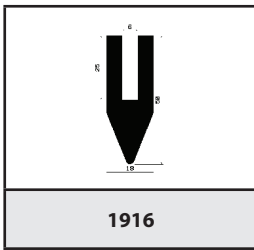

1916

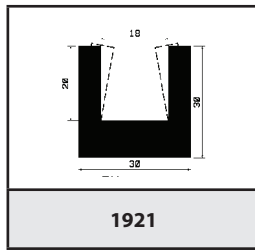

1921

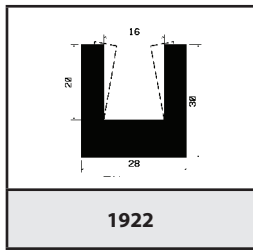

1922

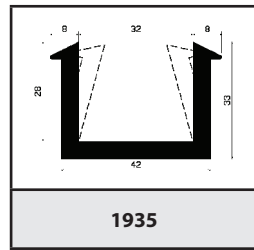

1935

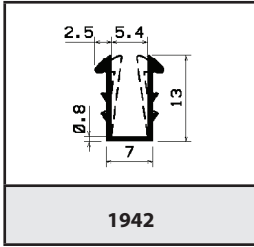

1942

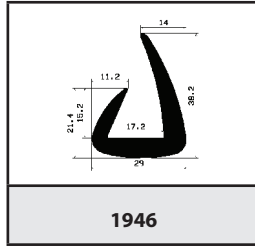

1946

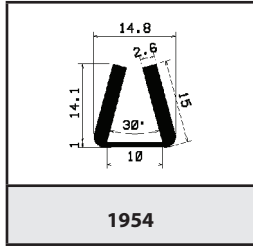

1954

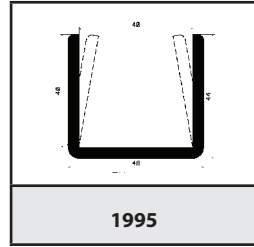

1995

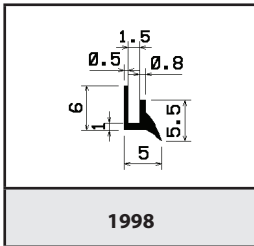

1998

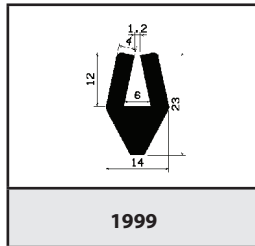

1999

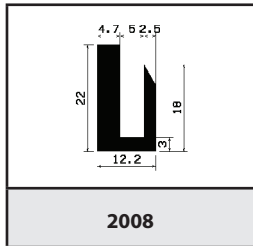

2008

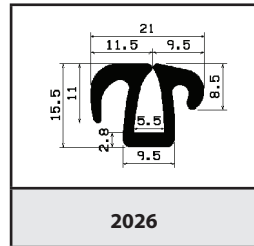

2026

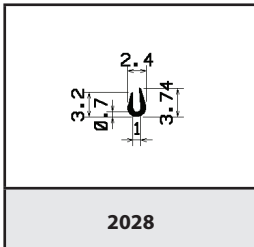

2028

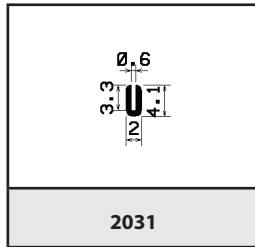

2031

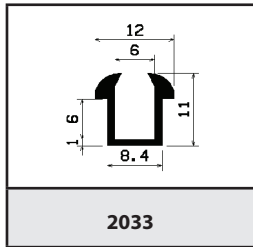

2033

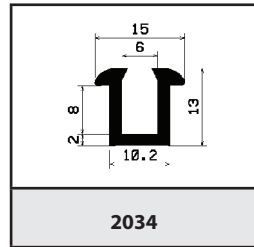

2034

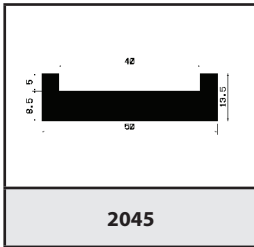

2045

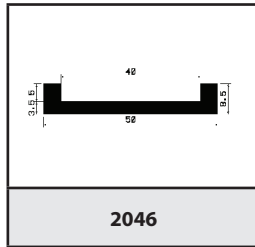

2046

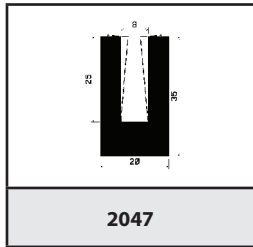

2047

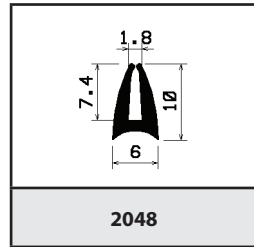

2048

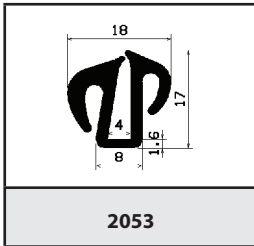

2053

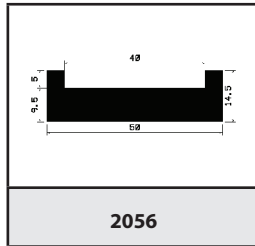

2056

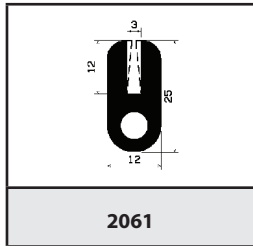

2061

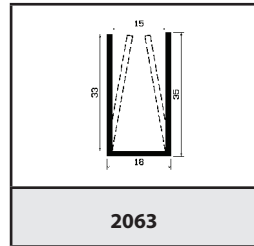

2063

○ Mikroporös-, mikroporös-/silikon-      ● gummi-, silikon-



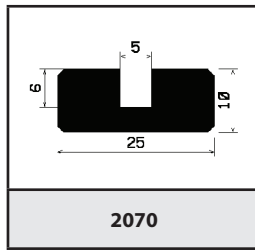

2070

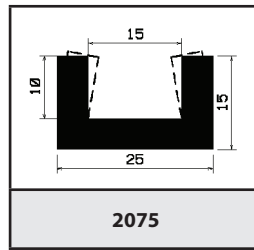

2075

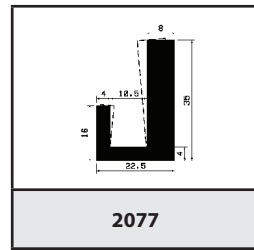

2077

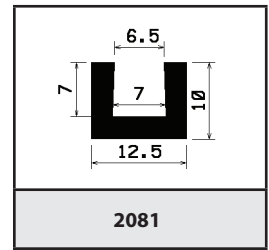

2081

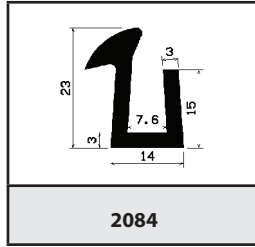

2084

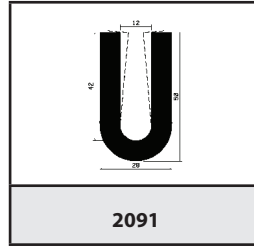

2091

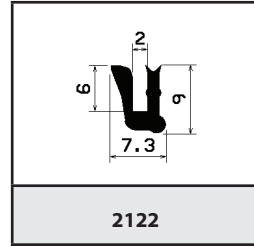

2122

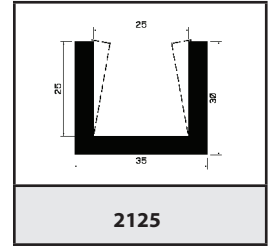

2125

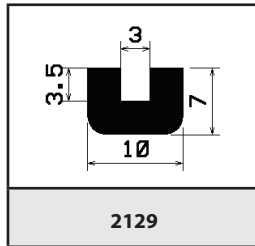

2129

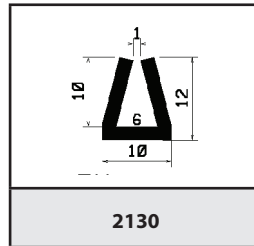

2130

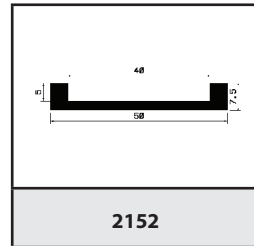

2152

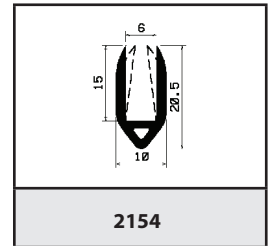

2154

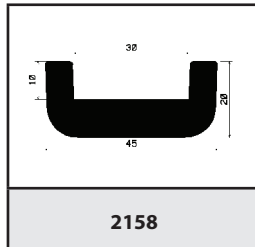

2158

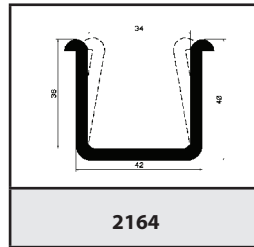

2164

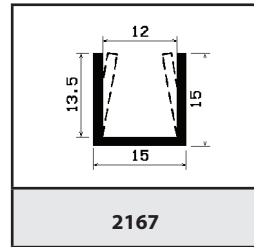

2167

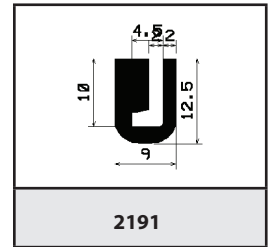

2191

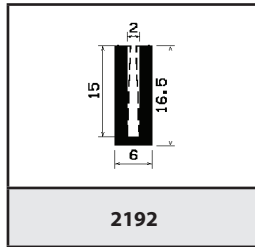

2192

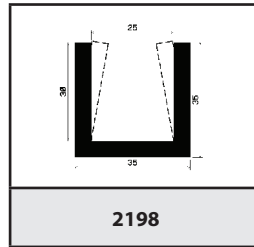

2198

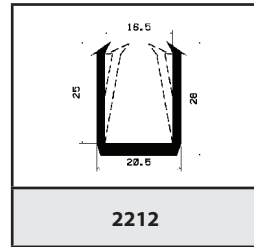

2212

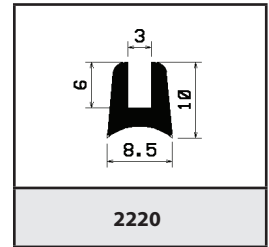

2220

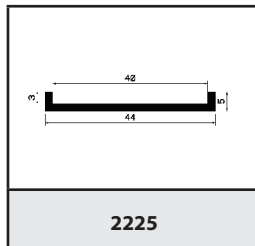

2225

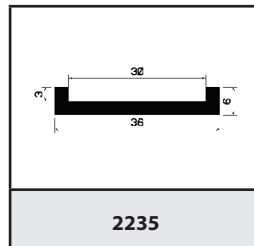

2235

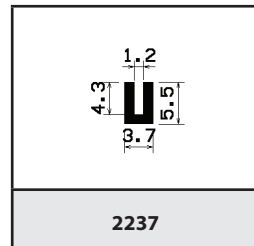

2237

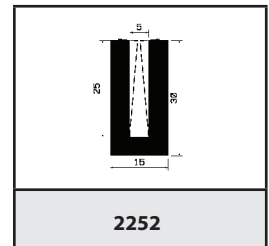

2252

○ Mikroporös-, mikroporös-/silikon- ● gummi-, silikon-

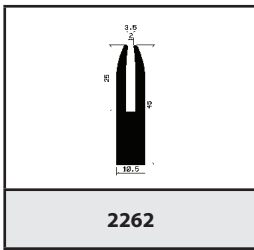

2262

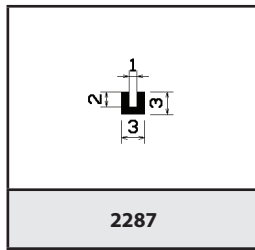

2287

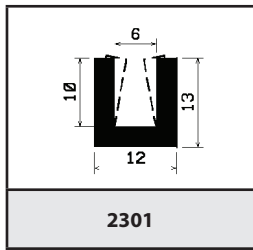

2301

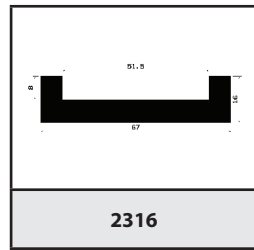

2316

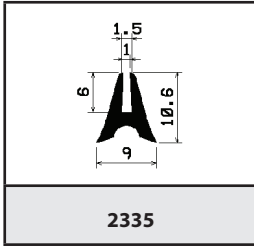

2335

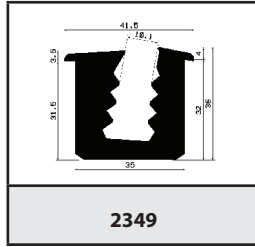

2349

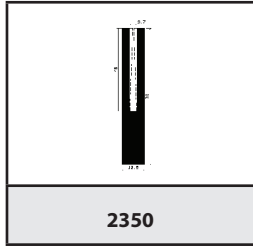

2350

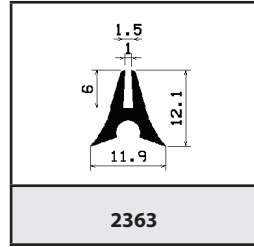

2363

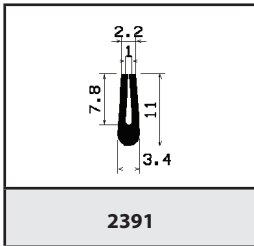

2391

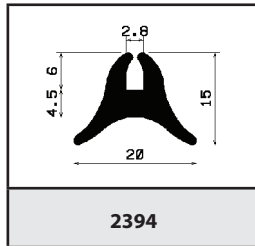

2394

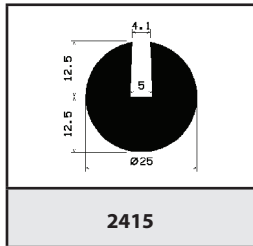

2415

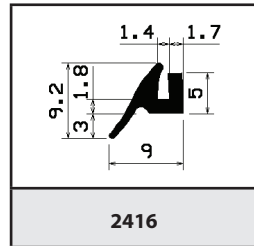

2416

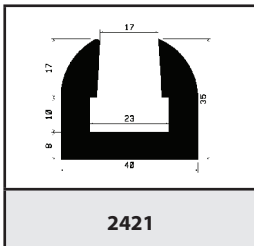

2421

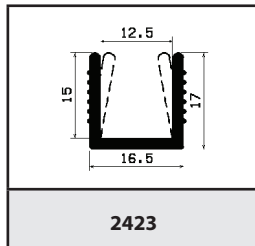

2423

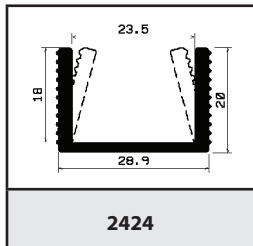

2424

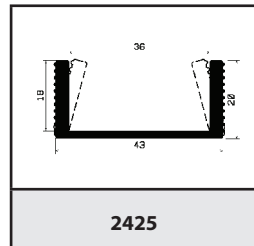

2425

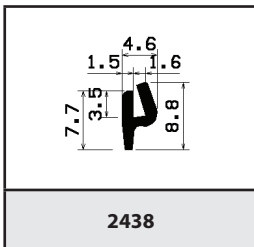

2438

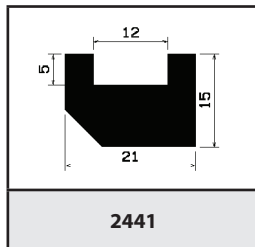

2441

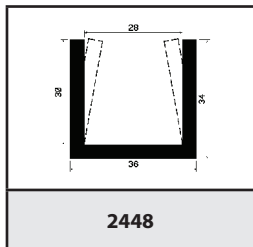

2448

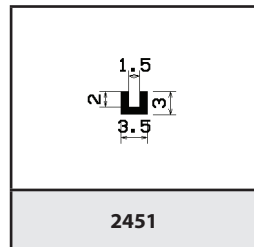

2451

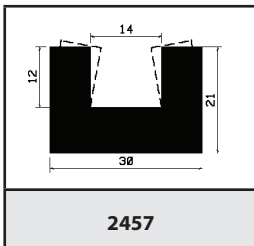

2457

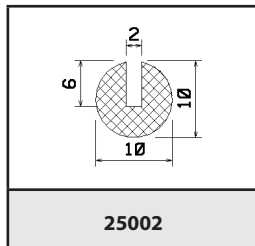

25002

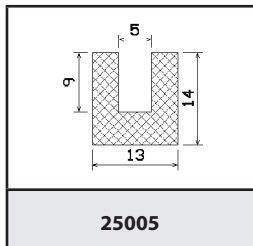

25005

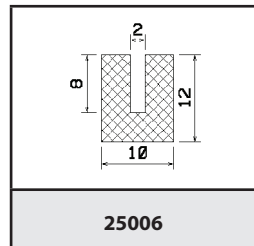

25006

○ Mikroporös-, mikroporös-/silikon-      ● gummi-, silikon-

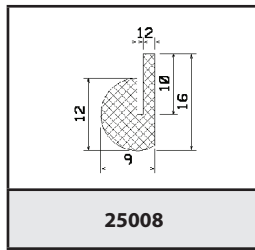

25008

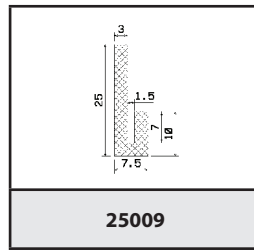

25009

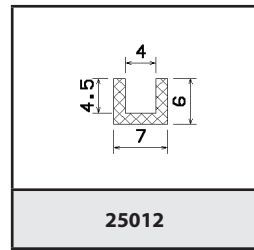

25012

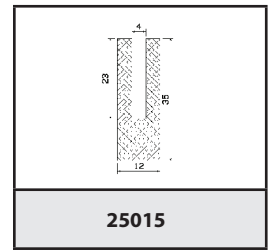

25015

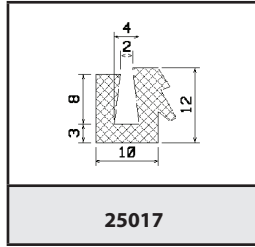

25017

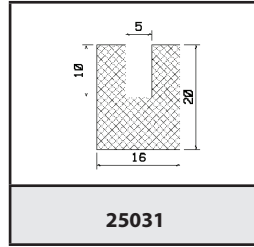

25031

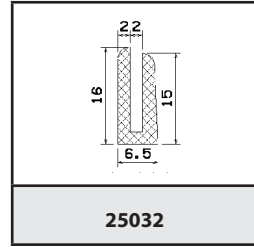

25032

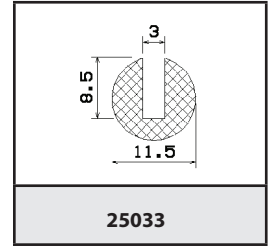

25033

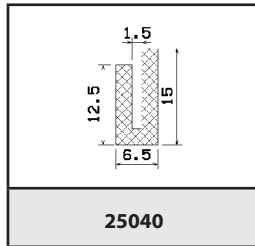

25040

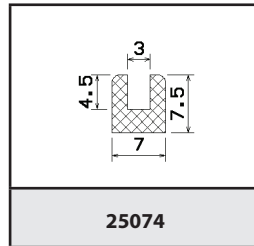

25074

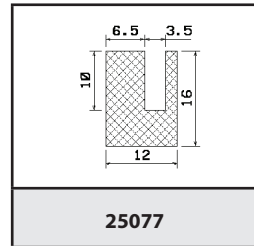

25077

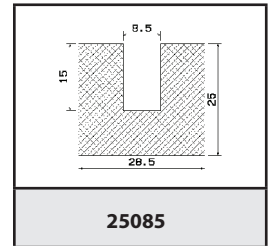

25085

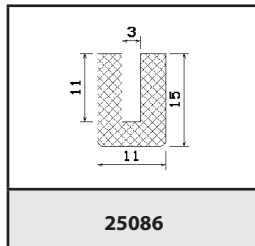

25086

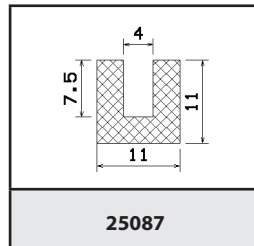

25087

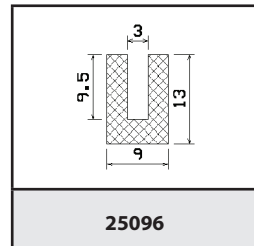

25096

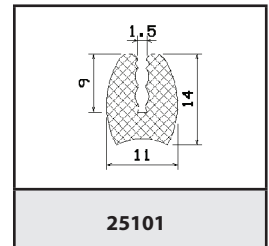

25101

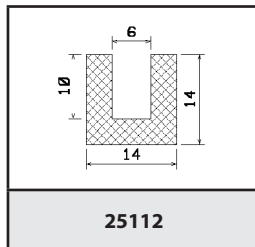

25112

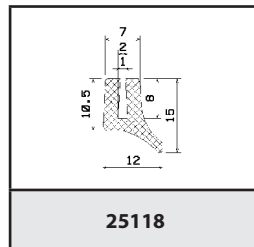

25118

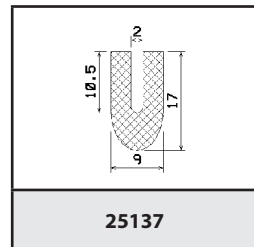

25137

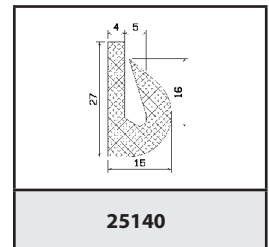

25140

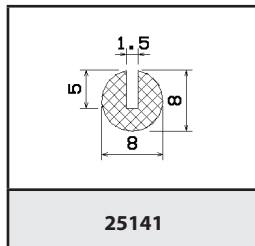

25141

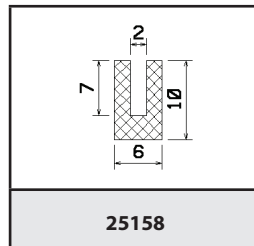

25158

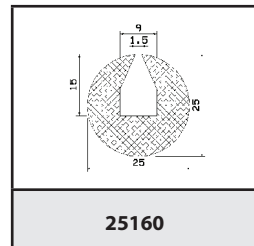

25160

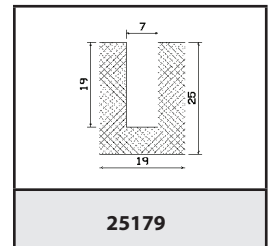

25179

○ Mikroporös-, mikroporös-/silikon- ● gummi-, silikon-

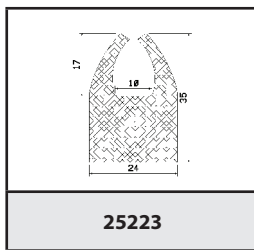

25223

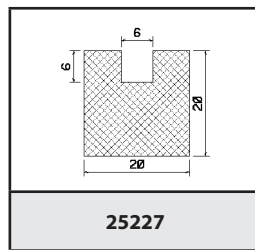

25227

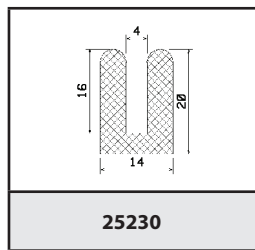

25230

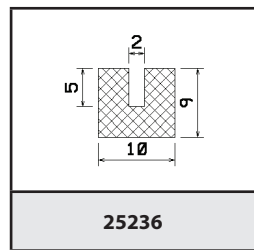

25236

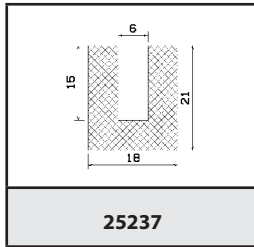

25237

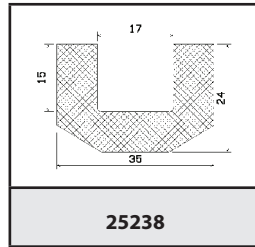

25238

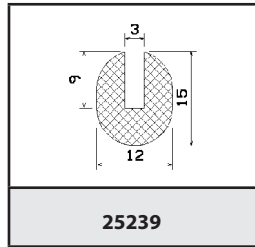

25239

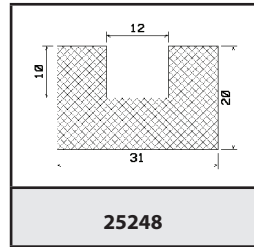

25248

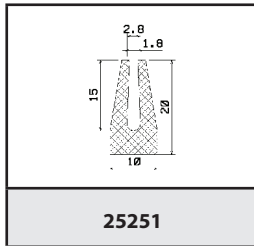

25251

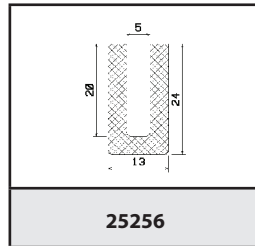

25256

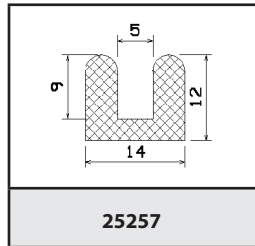

25257

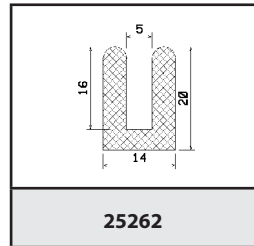

25262

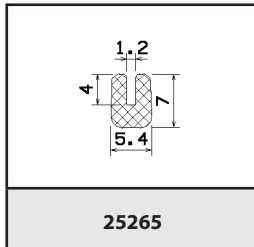

25265

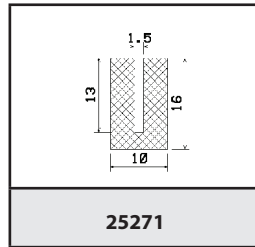

25271

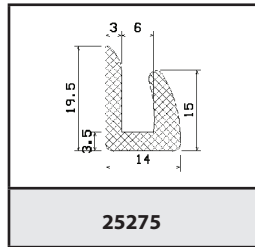

25275

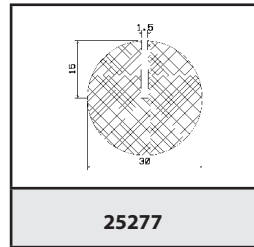

25277

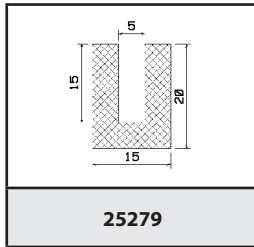

25279

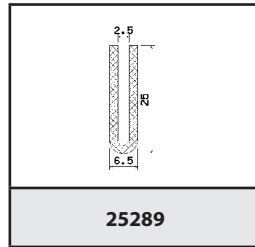

25289

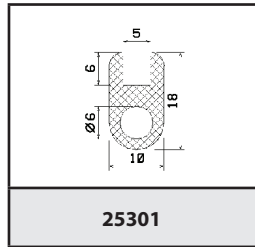

25301

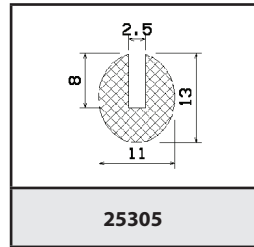

25305

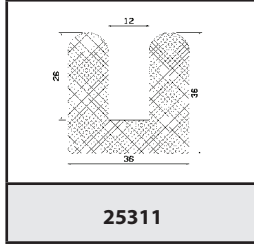

25311

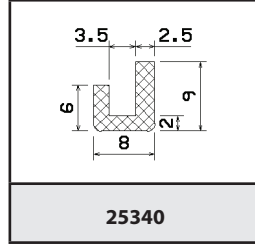

25340

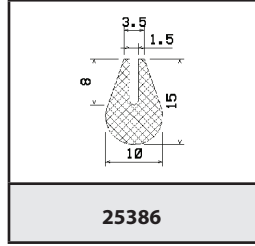

25386

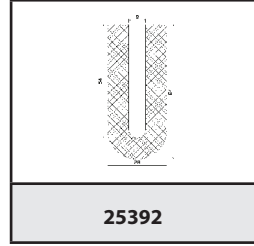

25392

○ Mikroporös-, mikroporös-/silikon-      ● gummi-, silikon-

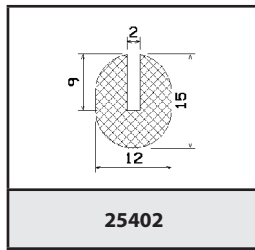

25402

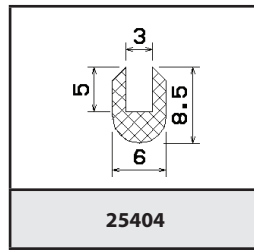

25404

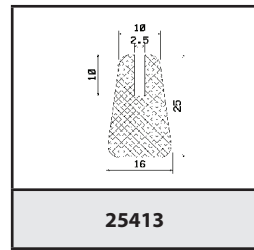

25413

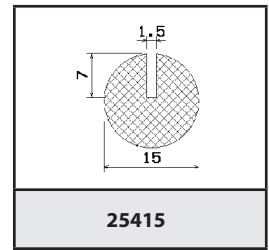

25415

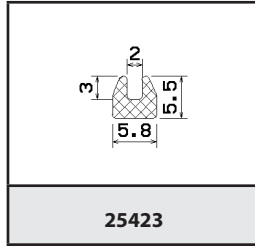

25423

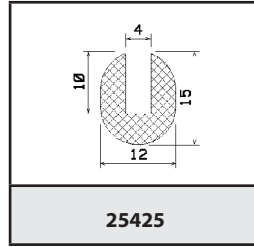

25425

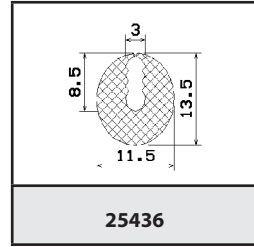

25436

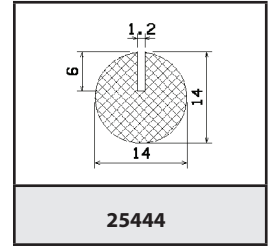

25444

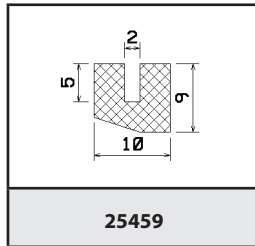

25459

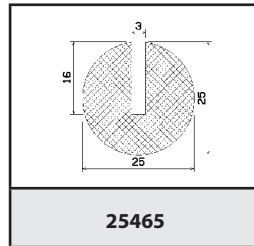

25465

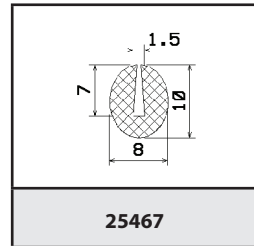

25467

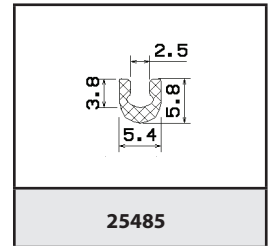

25485

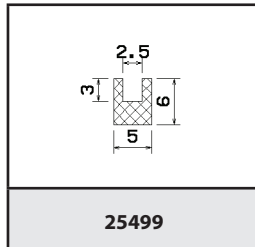

25499

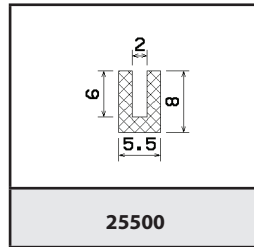

25500

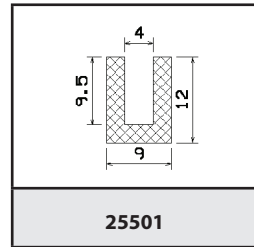

25501

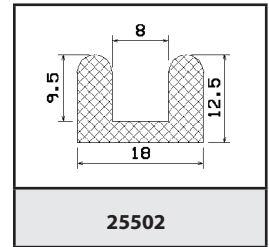

25502

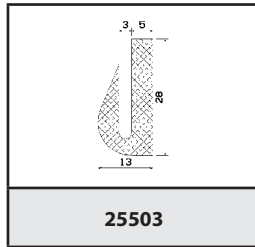

25503

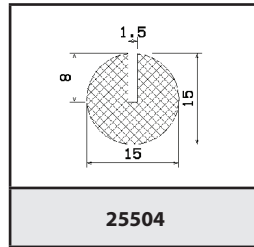

25504

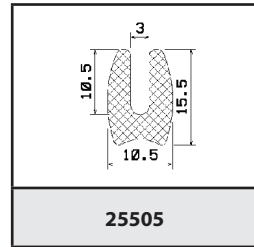

25505

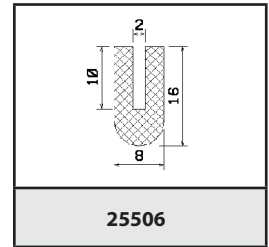

25506

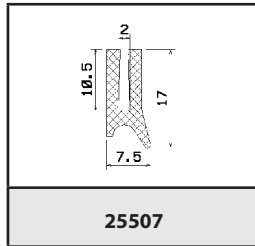

25507

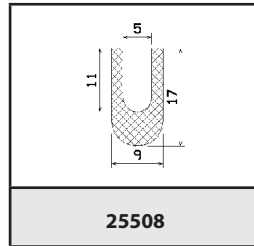

25508

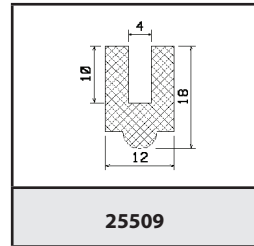

25509

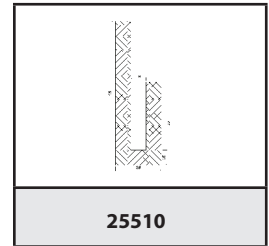

25510

○ Mikroporös-, mikroporös-/silikon-      ● gummi-, silikon-

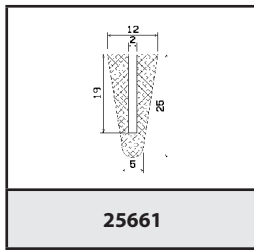

25661

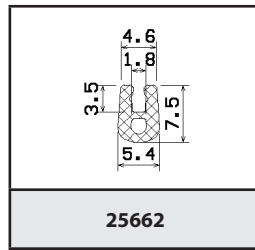

25662

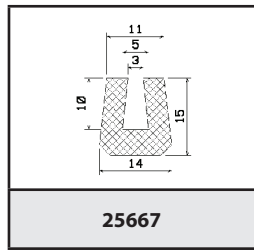

25667

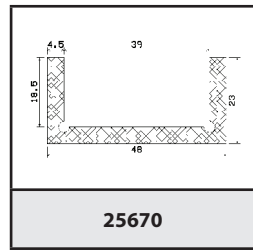

25670

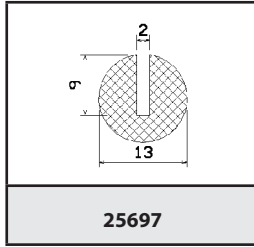

25697

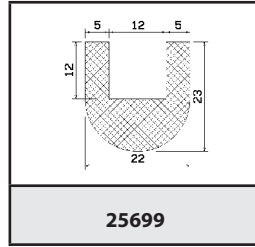

25699

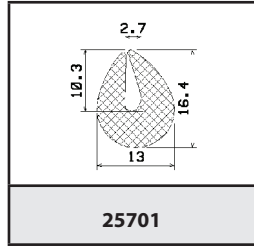

25701

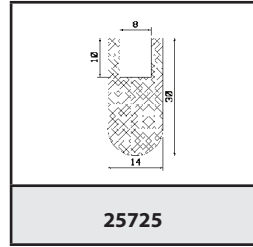

25725

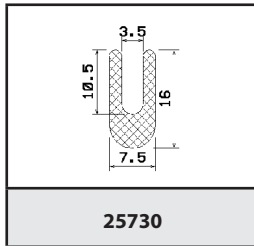

25730

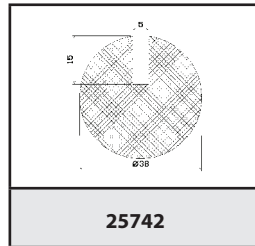

25742

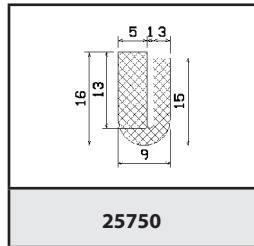

25750

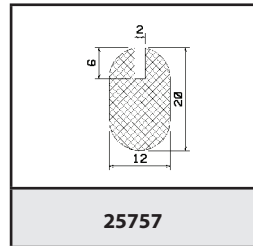

25757

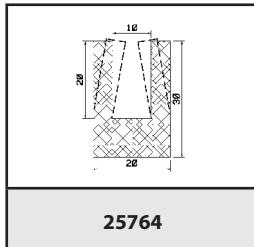

25764

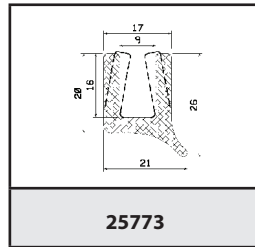

25773

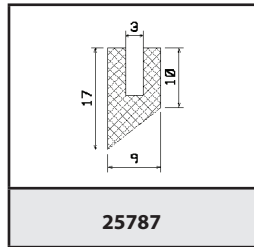

25787

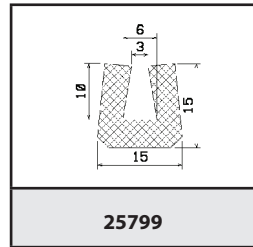

25799

○ Mikroporös-, mikroporös-/silikon-      ● gummi-, silikon-

# MIKROPORÖS

(Höhe x Breite)

02x06mm	04x20mm	06x11mm	09x16mm
02x06mm	04x25mm	06x12mm	09x23mm
02x08mm	04x25mm	06x12mm	09x23mm
02x08mm	04x30mm	06x13mm	10x100mm
02x09mm	04x30mm	06x15mm	10x10mm
02x09mm	04x35mm	06x15mm	10x10mm
02x10mm	04x35mm	06x16mm	10x10mm
02x10mm	04x40mm	06x16mm	10x10mm
02x15mm	04x40mm	06x20mm	10x11mm
02x15mm	04x45mm	06x20mm	10x11mm
02x20mm	04x45mm	06x22mm	10x12mm
02x20mm	04x50mm	06x25mm	10x12mm
02x25mm	04x50mm	06x25mm	10x15mm
02x25mm	04,5x05mm	06x30mm	10x15mm
02x50mm	04,5x06,5mm	06x30mm	10x16mm
02x50mm	05x05mm	06x35mm	10x16mm
03x03mm	05x05mm	06x35mm	10x17mm
03x03,5mm	05x06mm	06x40mm	10x17mm
03x05mm	05x06mm	06x40mm	10x18mm
03x05mm	05x08mm	06x42mm	10x18mm
03x06mm	05x08mm	06x50mm	10x20mm
03x10mm	05x10mm	06x50mm	10x20mm
03x10mm	05x10mm	06x70mm	10x20mm
03x110mm	05x10mm	06,5x08,5mm	10x20mm
03x110mm	05x12mm	07x07mm	10x23mm
03x113mm	05x12mm	07x10mm	10x23mm
03x113mm	05x14mm	07x10mm	10x25mm
03x12mm	05x15mm	07x15mm	10x25mm
03x12mm	05x15mm	07x15mm	10x30mm
03x141mm	05x15mm	07x20mm	10x30mm
03x15mm	05x18mm	07x20mm	10x30mm
03x15mm	05x20mm	07x50mm	10x30mm
03x18mm	05x20mm	07x60mm	10x35mm
03x18mm	05x20mm	07x70mm	10x35mm
03x20mm	05x25mm	08x08mm	10x40mm
03x20mm	05x25mm	08x08mm	10x40mm
03x22mm	05x25mm	08x10mm	10x40mm
03x25mm	05x28mm	08x10mm	10x40mm
03x25mm	05x30mm	08x12mm	10x45mm
03x30mm	05x30mm	08x12mm	10x45mm
03x30mm	05x35mm	08x15mm	10x50mm
03x35mm	05x35mm	08x15mm	10x50mm
03x35mm	05x40mm	08x16mm	10x50mm
03x40mm	05x40mm	08x16mm	10x50mm
03x40mm	05x40mm	08x18mm	10x50mm
03x50mm	05x42mm	08x18mm	10x60mm
03x50mm	05x45mm	08x20mm	10x60mm
03x95mm	05x45mm	08x20mm	10x70mm
04x04mm	05x50mm	08x20mm	10x70mm
04x05mm	05x50mm	08x25mm	10x70mm
04x05mm	05x50mm	08x25mm	11x14mm
04x05,7mm	05x50mm	08x30mm	11x15mm
04x06mm	05x60mm	08x30mm	11x17mm
04x06mm	05x60mm	08x35mm	11x18mm
04x07mm	05x65mm	08x35mm	11x26mm
04x08mm	05x70mm	08x40mm	12x12mm
04x08mm	05x70mm	08x40mm	12x12mm
04x10mm	06x06mm	08x45mm	12x15mm
04x10mm	06x06mm	08x50mm	12x15mm
04x10,5mm	06x08mm	08x50mm	12x15mm
04x12mm	06x08mm	09x09mm	12x16mm
04x12mm	06x09mm	09x09mm	12x17mm
04x15mm	06x09mm	09x11mm	12x18mm
04x15mm	06x100mm	09x12mm	12x18mm
04x16mm	06x10mm	09x12mm	12x20mm
04x20mm	06x10mm	09x16mm	12x20mm

MIKROPORÖS

(Höhe x Breite)

12x25mm
12x25mm
12x28mm
12x28mm
12x30mm
12x30mm
12x40mm
12x40mm
12x45mm
12x50mm
12x50mm
12,4x12,4mm
13x13mm
13x18mm
13x20mm
13x30mm
14x14mm
14x16mm
14x17mm
14x18mm
15x15mm
15x15mm
15x15mm
15x18mm
15x18mm
15x20mm
15x20mm
15x25mm
15x25mm
15x30mm
15x30mm
15x30mm
15x30mm
15x35mm
15x35mm
15x40mm
15x40mm
15x40mm
15x45mm
15x45mm
15x50mm
15x50mm
16x16mm
16x16mm
16x20mm
16x20mm
16x22mm
16x22mm
16x28mm
16x28mm
16x30mm
16x30mm
17x20mm
17x24mm
17x24mm
17x25mm
17x25mm
18x18mm
18x18mm
18x20mm
18x20mm
18x22mm
18x22mm
18x25mm
18x25mm
20x100mm
20x20mm

SILICONE

(Höhe x Breite)

20x20mm
20x20mm
20x25mm
20x25mm
20x30mm
20x30mm
20x30mm
20x30mm
20x35mm
20x35mm
20x40mm
20x40mm
20x45mm
20x45mm
20x50mm
20x50mm
20x50mm
20x60mm
20x60mm
22x33mm
23x23mm
23x25mm
23x25mm
25x25mm
25x25mm
25x30mm
25x30mm
25x33mm
25x33mm
25x35mm
25x35mm
25x40mm
25x40mm
25x45mm
25x50mm
25x50mm
28x28mm
30x30mm
30x30mm
30x35mm
30x35mm
30x40mm
30x40mm
30x40mm
30x50mm
30x50mm
30x50mm
40x40mm
40x40mm
40x50mm
40x50mm
40x60mm
40x60mm
45x45mm
45x50mm
45x50mm
50x50mm
50x50mm

02x10mm
02x15mm
02x20mm
02x25mm
02x50mm
02x57mm
03x10mm
03x20mm
03x25mm
03x30mm
03x40mm
03x50mm
03x100mm
03,5x03,5mm
04x05,5mm
04x09,5mm
04x23mm
04x25mm
04x40mm
04x40mm
04x40mm
04x60mm
05x07,5mm
05x14mm
05x20mm
05x35mm
05x40mm
05x40mm
05x50mm
05x80mm
06x10mm
06x12mm
06x25mm
06x60mm
06x80mm
07x70mm
07x90mm
08x14mm
08x18mm
08x40mm
08x40mm
08x80mm
10x10mm
10x15mm
10x16mm
10x20mm
10x25mm
10x30mm
10x40mm
12x14mm
12x15mm
12x18mm
13x16mm
14x14mm
14x15mm
14x18mm
14x20mm
15x15mm
15x19mm
15x20mm
15x25mm
15x30mm
16x16mm
16x20mm
20x20mm
20x26mm

20x30mm
25x25mm
25x55mm
25x65mm
27x27mm
30x30mm
50x50mm



## SILICONE MIKROPORÖS

(Höhe x Breite)

01,50x20mm	06x06mm	18x18mm
02x10mm	06x70mm	18x23mm
02x10,50mm	06,50x06,50mm	18,50x20mm
02x15mm	07x10mm	20x20mm
02x20mm	07x12mm	20x25mm
02x20mm	07x15mm	20x30mm
02x25mm	07x70mm	20x35mm
02x30mm	08x08mm	20x35mm
02x60mm	08x10mm	20x40mm
03x05mm	08x12mm	20x50mm
03x06mm	08x14mm	20x55mm
03x08mm	08x15mm	20x70mm
03x09mm	08x17mm	22x22mm
03x10mm	08x20mm	23x25mm
03x12mm	08x24mm	24x24mm
03x15mm	08x25mm	25x25mm
03x16mm	08x30mm	25x30mm
03x20mm	08x35mm	25x35mm
03x25mm	08x38mm	25x40mm
03x26,30mm	08x40mm	25x65mm
03x30mm	08x45mm	30x30mm
03x35mm	09x13mm	30x35mm
03x40mm	09x20mm	30x40mm
03x60mm	09,50x14mm	30x45mm
03x8mm	10x10mm	30x50mm
04x05mm	10x12mm	30x60mm
04x10mm	10x13mm	35x35mm
04x12mm	10x15mm	35x40mm
04x15mm	10x16mm	40x40mm
04x20mm	10x18mm	40x40mm
04x22mm	10x20mm	40x40mm
04x30mm	10x22mm	40x100mm
04x40mm	10x25mm	50x50mm
04,50x10mm	10x30mm	60x60mm
04,50x15mm	10x35mm	
04,50x70mm	10x40mm	
04,75x25,40mm	10x45mm	
05x05mm	10x50mm	
05x06mm	10x60mm	
05x08mm	11x16mm	
05x10mm	12x12mm	
05x15mm	12x14mm	
05x20mm	12x15mm	
05x22,50mm	12x16mm	
05x25mm	12x18mm	
05x30mm	12x20mm	
05x35mm	12x25mm	
05x40mm	12x30mm	
05x50mm	12x35mm	
05x59mm	12x40mm	
05x60mm	13x20mm	
05x70mm	15x15mm	
05x80mm	15x17mm	
06x06mm	15x18mm	
06x08mm	15x18,50mm	
06x10mm	15x20mm	
06x10mm	15x22mm	
06x12mm	15x25mm	
06x15mm	15x30mm	
06x16mm	15x35mm	
06x20mm	15x40mm	
06x25mm	15x50mm	
06x30mm	16x16mm	
06x40mm	16x18mm	
06x50mm	16x20mm	
06x60mm	17x20mm	

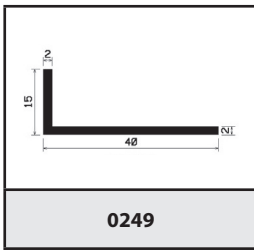

0249

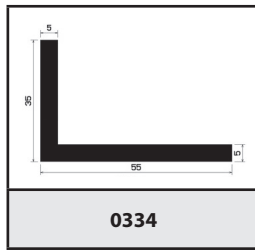

0334

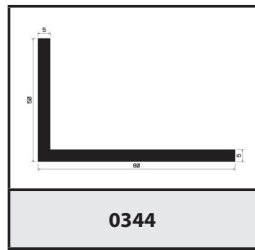

0344

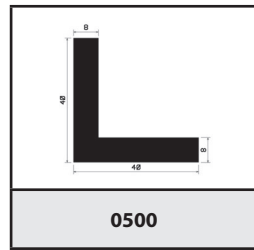

0500

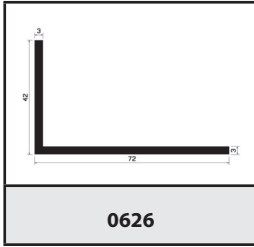

0626

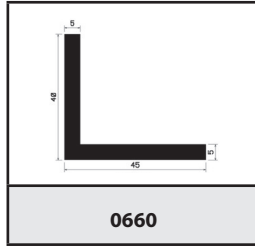

0660

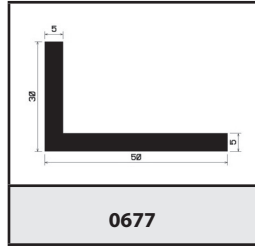

0677

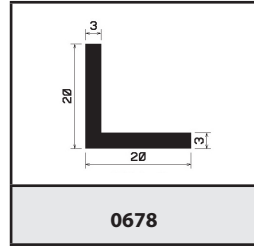

0678

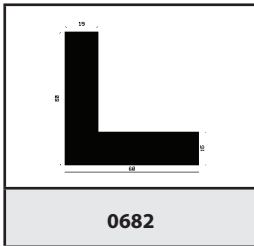

0682

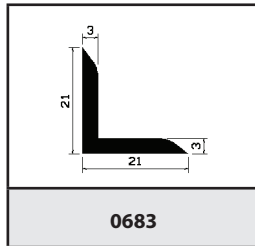

0683

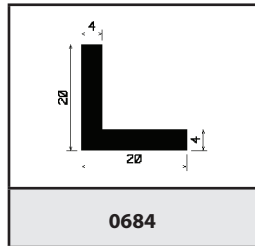

0684

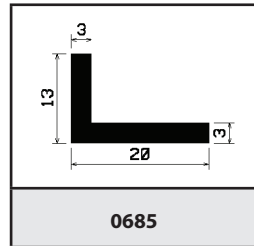

0685

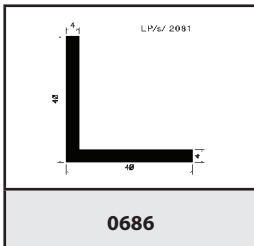

0686

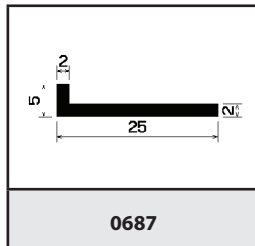

0687

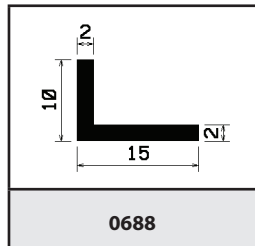

0688

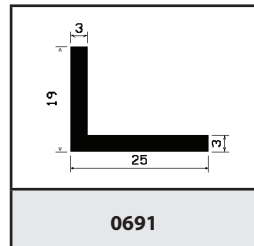

0691

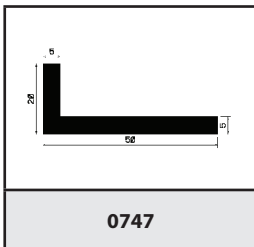

0747

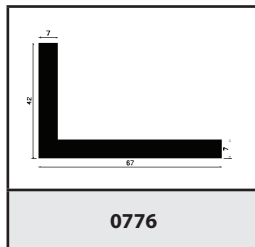

0776

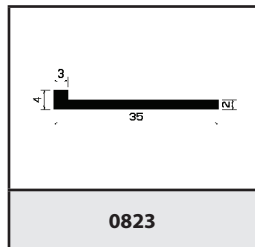

0823

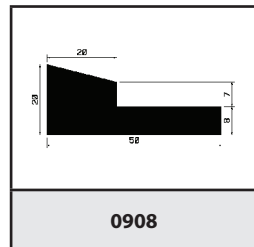

0908

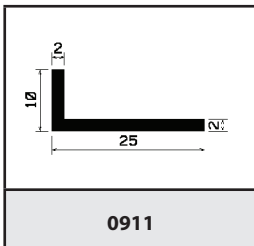

0911

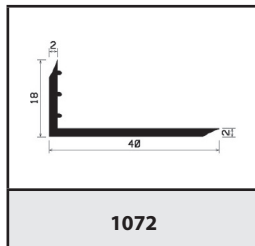

1072

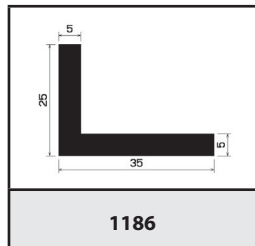

1186

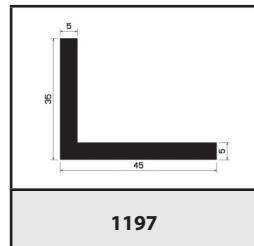

1197

○ Mikroporös-, mikroporös-/silikon-      ● gummi-, silikon-

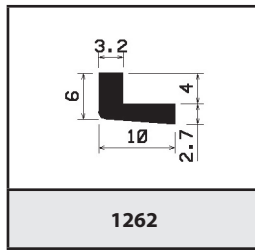

1262

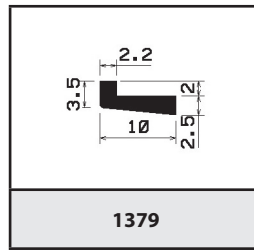

1379

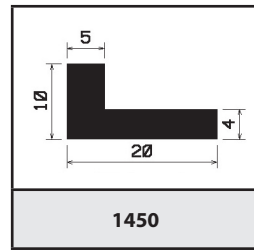

1450

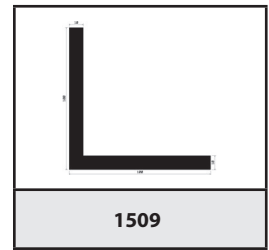

1509

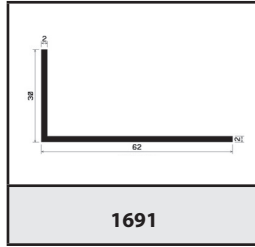

1691

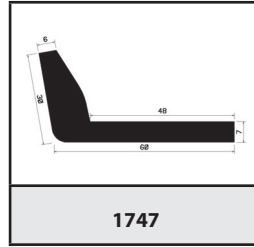

1747

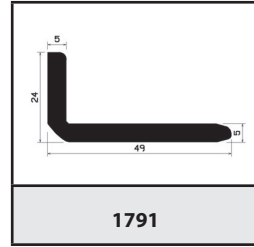

1791

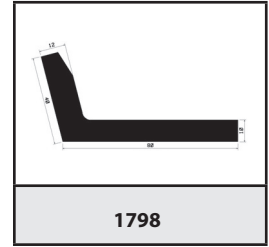

1798

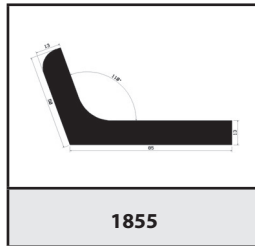

1855



1863

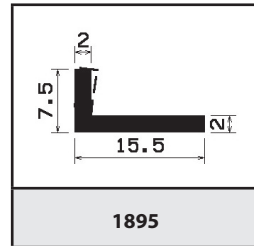

1895

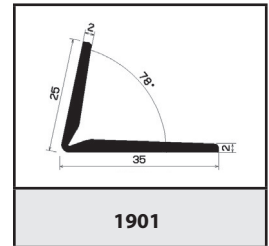

1901

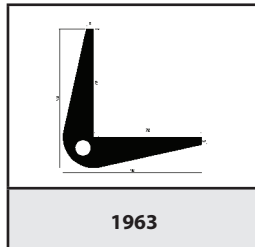

1963

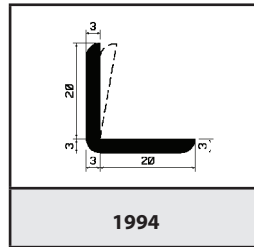

1994

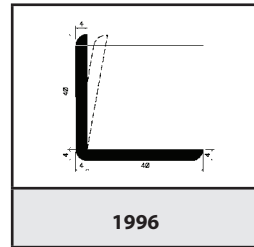

1996

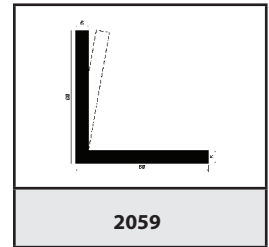

2059

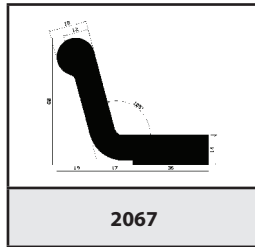

2067

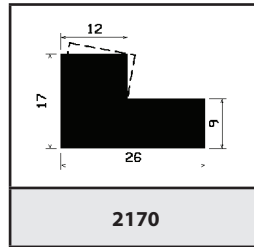

2170

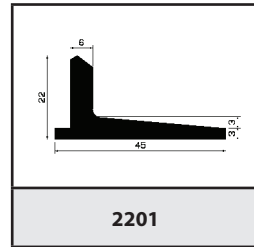

2201

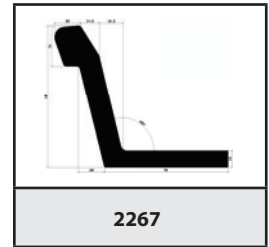

2267

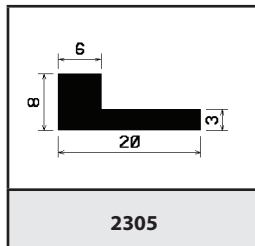

2305

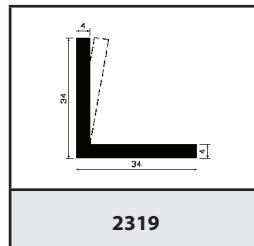

2319

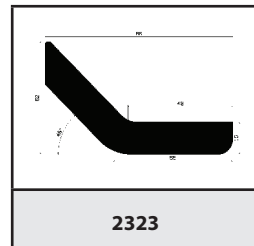

2323

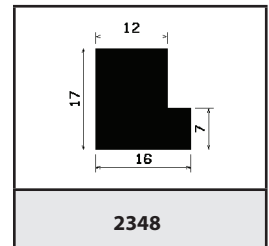

2348

○ Mikroporös-, mikroporös-/silikon-      ● gummi-, silikon-

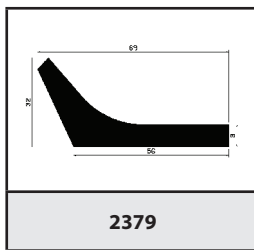

2379

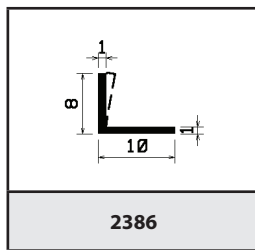

2386

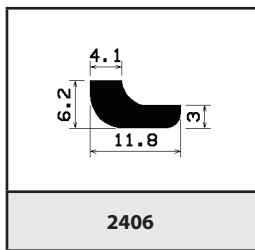

2406

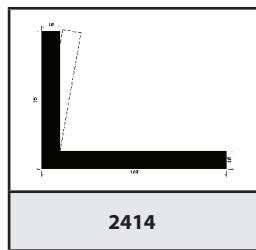

2414

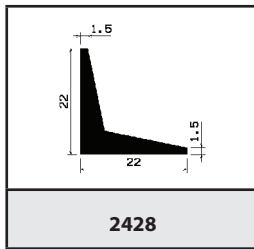

2428

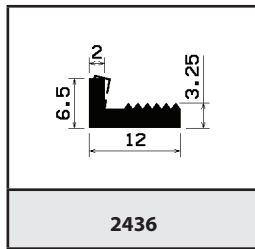

2436

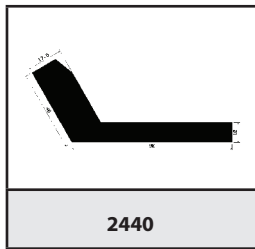

2440

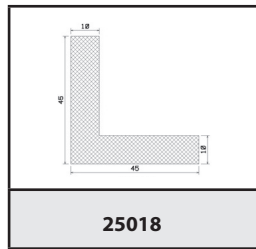

25018

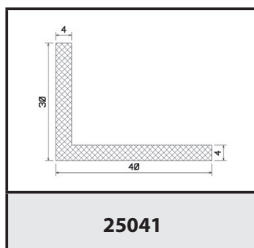

25041

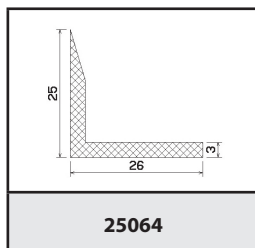

25064

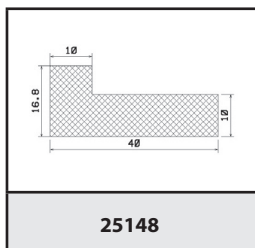

25148

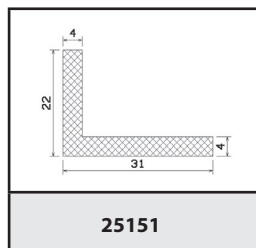

25151

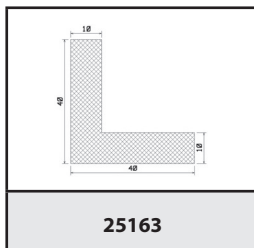

25163

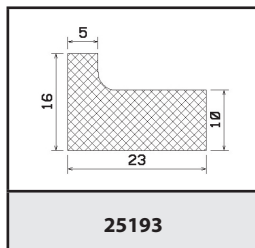

25193

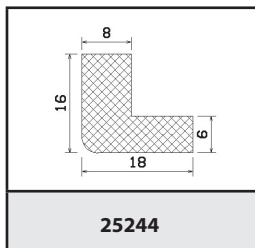

25244

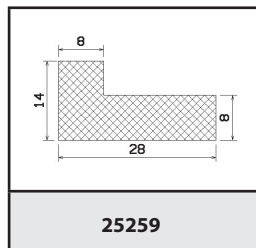

25259

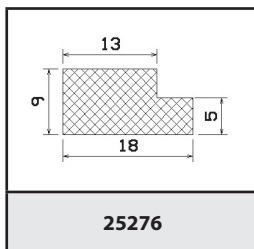

25276

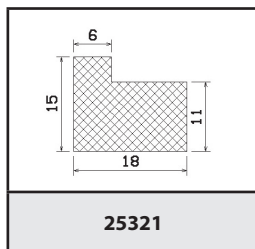

25321

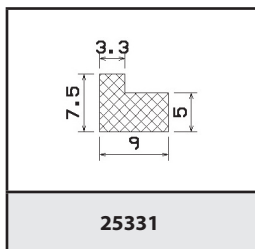

25331

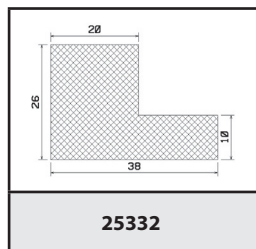

25332

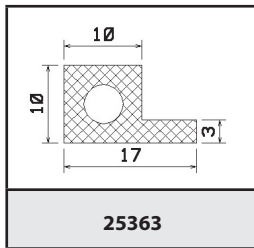

25363

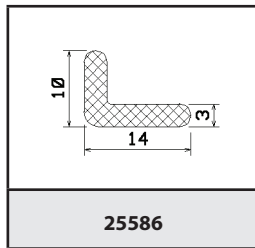

25586

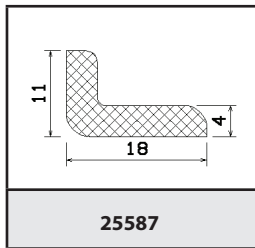

25587

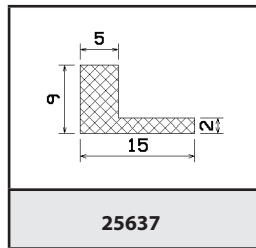

25637

○ Mikroporös-, mikroporös-/silikon-      ● gummi-, silikon-

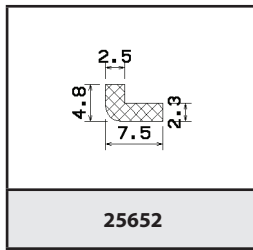

25652

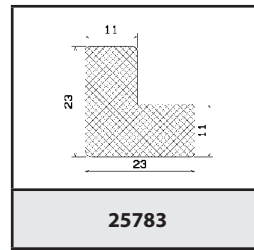



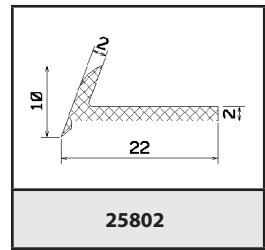





















25783





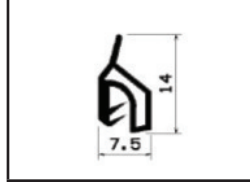

















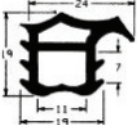

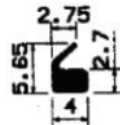
25802

○ Mikroporös-, mikroporös-/silikon- ● gummi-, silikon-

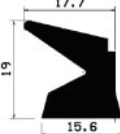
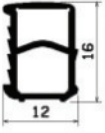
			
0009	0097	0118	0247
			
0288	0359	0375	0376
			
0381	0392	0416	0422
			
0429	0436	0467	0490
			
0497	0501	0508	0510
			
0540	0556	0575	0586

○ Mikroporös-, mikroporös-/silikon-      ● gummi-, silikon-

			
0602	0619	0634	0640
			
0641	0642	0666	0732
			
0745	0759	1015	1223
			
1296	1306	1417	1695
			
1728	1783	1851	1889
			
1897	2120	2366	2476

○ Mikroporös-, mikroporös-/silikon- ● gummi-, silikon-

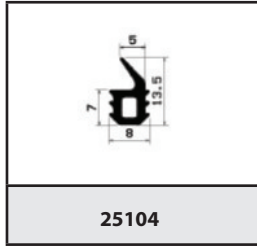
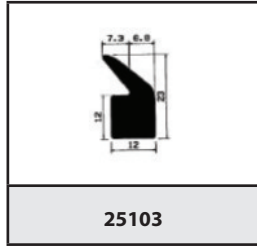
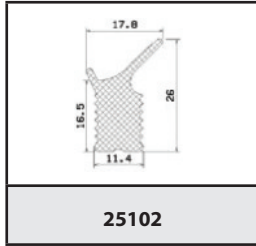
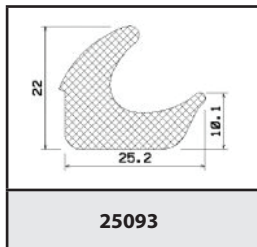
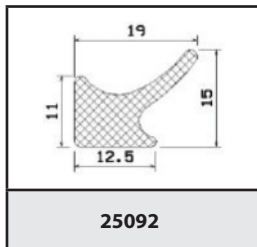
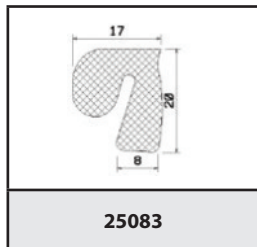
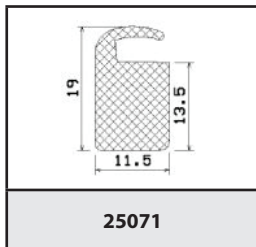
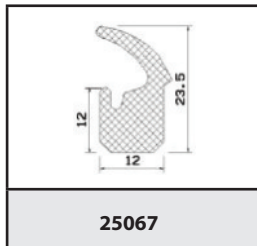
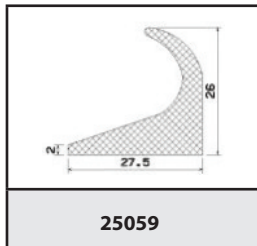
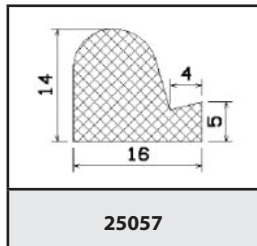
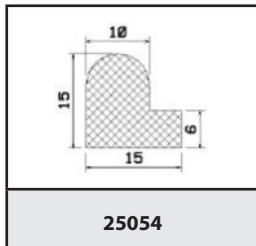
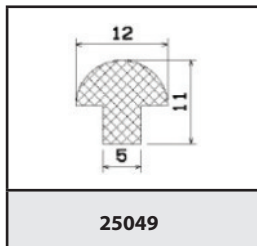
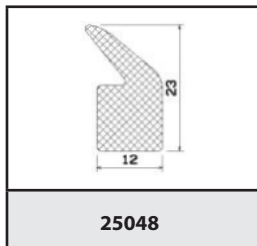
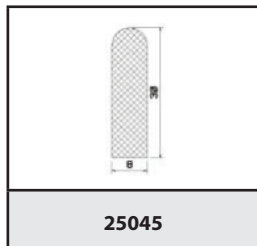
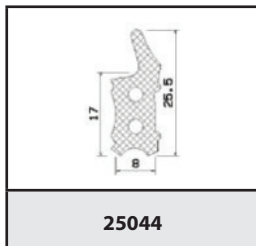
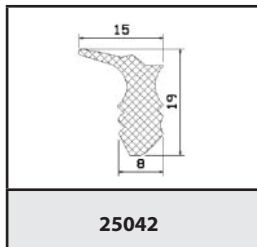
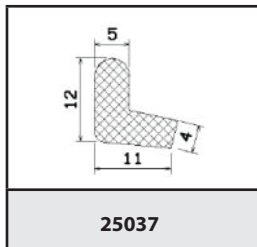
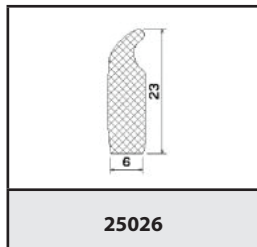
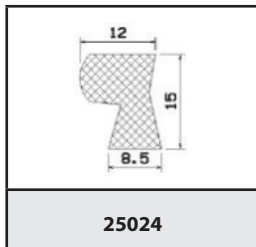
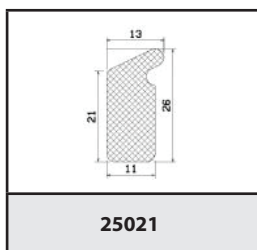
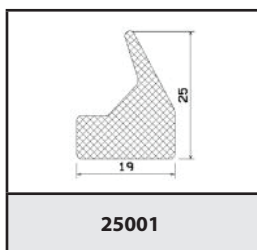
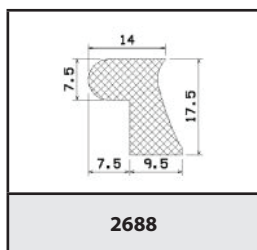
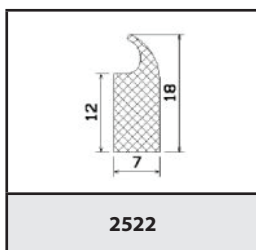

○ Mikroporös-, mikroporös-/silikon- ● gummi-, silikon-





*....dichtet sofort*

**Adresse:**

Vrbovec 321, 671 24 Vrbovec, Tschechische Republik

**Email:**

info@aditeg.cz

**Telefon / fax:**

+420 515 320 023 / +420 515 320 024

**Id. Nr. / St.Id. Nr.:**

26905710 / CZ26905710

**[www.aditeg.cz](http://www.aditeg.cz)**