

Kompaktní rozbočovače

komfortní a kompaktní

 **EROCOMM**

 **EROCOMM SK**





FTG

38401R

Ui: 1000V AC
1500V DC

In: 400A

CE



Rozsáhlý program kompaktních rozbočovačů FTG, nabízí nespočet okamžitých řešení a je jedno, zda používáte vodiče sektorově tvarované, kruhové, ploché, hliníkové nebo měděné.

Kompaktní rozbočovače

Vedle časové úspory šetří FTG-rozbočovací bloky také prostor v rozváděčích. Díky malým rozměrům a kompaktní technice, najdou rozbočovací bloky vždy svoje místo.

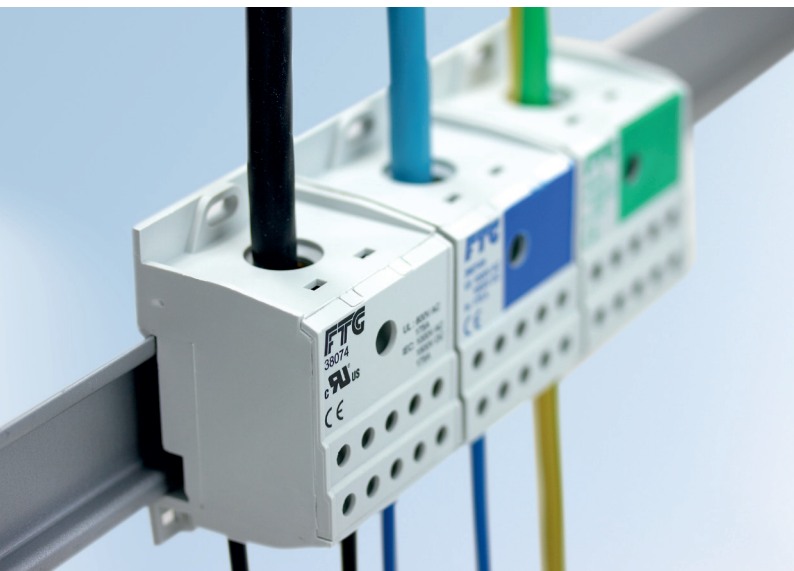













Tak, jako mnoho jiných výrobků FTG, nabízí kompaktní rozbočovače možnost snížit dobu montáže. Jednotlivé moduly můžete snadno nasadit na DIN-lištu a pokud je třeba, opět sejmout. Lze též rozbočovače přišroubovat přímo na montážní desku. Mohou být přivedeny vodiče až s průřezem 240 mm², moduly mohou být zatíženy až 800 A. Na výstupu může být až 11 vodičů, dokonce s různými průřezy až do 240 mm².

















- napájení sektorově tvarovanými, kruhovými nebo plochými vodiči
- velký počet výstupních svorek
- některé typy možno nasadit na měděnou pásovinu
- časově a prostorově úsporné
- krytí IP 20
- částečně ve shodě s UL
- až do 800 A
- přívod až do 240 mm²
- výstup až do 240 mm²
- vysoká zkratová pevnost (až do Ipk 50 kA)
- 1 – pólové moduly
- jednotlivé moduly možno složit až do 5-pólové sestavy







1-pólové kompaktní rozbočovače







	1 x 16 - 50 mm ²	
	1 x 16 - 70 mm ²	
	10 x 2,5 - 10 mm ²	
	10 x 2,5 - 16 mm ²	
	71 x 45 x 42,5 mm	
CU	38074	1000V AC, 1500V DC 175A (IEC) 600V AC 175A 
N	38074N	1000V AC, 1500V DC 175A (IEC)
PE	38074PE	1000V AC, 1500V DC 175A (IEC)
AL	38074AL	1000V AC, 1500V DC 125A (IEC)







	Měděná pásovina do 15 x 5 mm	
	1 x 10 - 50 mm ²	
	1 x 10 - 70 mm ²	
	6 x 2,5 - 16 mm ²	
	6 x 2,5 - 16 mm ²	
	92 x 35 x 49 mm	
CU	38032	1000V AC, 1500V DC 160A (IEC) 600V AC 160A 
AL	38032AL	1000V AC, 1500V DC 125A (IEC)

	1 x 25 - 70 mm ²	
	1 x 35 - 120 mm ²	
	2 x 6 - 25 mm ² 5 x 1,5 - 16 mm ² 4 x 1,5 - 10 mm ²	
	2 x 6 - 35 mm ² 5 x 1,5 - 16 mm ² 4 x 1,5 - 10 mm ²	
	95,5 x 44,5 x 49 mm	
CU	38020	1000V AC, 1500V DC 250A (IEC) 600V 230A 
AL	38020AL	1000V AC, 1500V DC 200A (IEC)

	1 x 95 - 150 mm ²	
	1 x 95 - 185 mm ²	
	2 x 6 - 25 mm ² 5 x 1,5 - 10 mm ² 4 x 1,5 - 10 mm ²	
	2 x 6 - 35 mm ² 5 x 1,5 - 16 mm ² 4 x 1,5 - 10 mm ²	
	95,5 x 44,5 x 49 mm	
CU	38019	1000V AC, 1500V DC 400A (IEC) 600V AC 310A 
AL	38019AL	1000V AC, 1500V DC 300A (IEC)

	Měděná pásovina do 24 x 6 mm	
	Měděná pásovina do 24 x 6 mm	
	2 x 2,5 - 35 mm ² 5 x 2,5 - 16 mm ² 4 x 2,5 - 10 mm ²	
	2 x 2,5 - 35 mm ² 5 x 2,5 - 16 mm ² 4 x 2,5 - 10 mm ²	
	95,5 x 44,5 x 49 mm	
CU	38044	1000V AC, 1500V DC 500A (IEC)

	2 x 2,5 - 16 mm ²	
	2 x 2,5 - 16 mm ²	
	4 x 2,5 - 6 mm ² 2 x 2,5 - 16 mm ²	
	4 x 2,5 - 6 mm ² 2 x 2,5 - 16 mm ²	
	66 x 27 x 47 mm	
CU	38049	1000V AC, 1500V DC 80A (IEC) 600V AC 80A 
PE	38049PE	1000V AC, 1500V DC 80A (IEC)
AL	38049AL	1000V AC, 1500V DC 63A (IEC)

	1 x 10 - 35 mm ² 1 x 6 - 16 mm ²	
	1 x 10 - 35 mm ² 1 x 6 - 16 mm ²	
	6 x 2,5 - 16 mm ²	
	6 x 2,5 - 16 mm ²	
	74 x 27 x 47 mm	
CU	38041	1000V AC, 1500V DC 125A (IEC) 600V AC 115A 
N	38041N	1000V AC, 1500V DC 125A (IEC)
PE	38041PE	1000V AC, 1500V DC 125A (IEC)
AL	38041AL	1000V AC, 1500V DC 100A (IEC)

	1 x 10 - 35 mm ²	
	1 x 10 - 35 mm ²	
	1 x 10 - 35 mm ² 3 x 1,5 - 16 mm ²	
	1 x 10 - 35 mm ² 3 x 1,5 - 16 mm ²	
	68 x 35,3 x 45 mm	
CU	38083	1000V AC, 1500V DC 125A (IEC)

1-, 2-pólové kompaktní rozbočovače

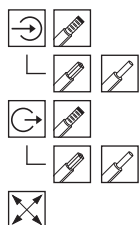

1 x 10 - 35 mm²
 1 x 10 - 50 mm²
 10 x 2,5 - 10 mm²
 10 x 2,5 - 16 mm²
 71 x 45 x 42,5 mm



CU 38076 1000V AC, 1500V DC | 125A (IEC) | 600V | 115A

AL 38076AL 1000V AC, 1500V DC | 100A (IEC)

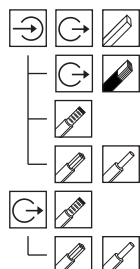

Měděná pásovina do 20 x 12 mm
 Lamelová pásovina do 20 x 1 x 11 mm
 1 x 16 - 185 mm²
 1 x 35 - 240 mm²
 1 x 16 - 185 mm²
 1 x 35 - 240 mm²
 145 x 40 x 81 mm



CU 38061 1000V AC, 1500V DC | 400A (IEC)

AL 38061 1000V AC, 1500V DC | 300A (IEC)

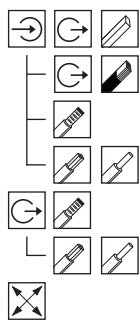

Měděná pásovina do 50 x 10 mm | 20x15 mm
 Lamelová pásovina do 50 x 1x10 mm | 24x1x10 mm
 1 x 16 - 185 mm²
 1 x 35 - 240 mm², 50 mm šíře
 2 x 16 - 240 mm²
 2 x 35 - 240 mm²
 145 x 72 x 80 mm



CU 38062 1000V AC, 1500V DC | 800A (IEC)

AL 38062 1000V AC, 1500V DC | 630A (IEC)

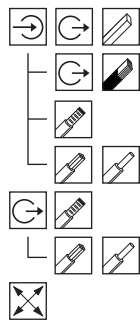

Měděná pásovina do 20 x 12 mm
 Lamelová pásovina do 20 x 1 x 10 mm
 2 x 16 - 185 mm²
 2 x 35 - 240 mm²
 2 x 16 - 185 mm²
 2 x 35 - 240 mm²
 145 x 72 x 80 mm



CU 38063 1000V AC, 1500V DC | 800A (IEC)

AL 38063 1000V AC, 1500V DC | 630A (IEC)

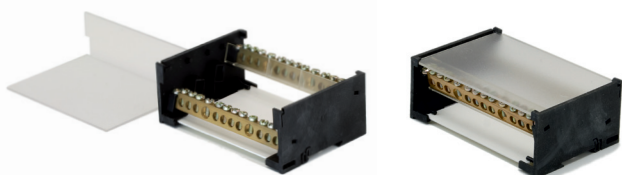

2 x 25 mm² na pól (provedení 2-pólové)
 10 x 16 mm² na pól (provedení 2-pólové)
 129 x 85 x 48 mm

CU 38022 1000V AC, 1500V DC | 125A (IEC)

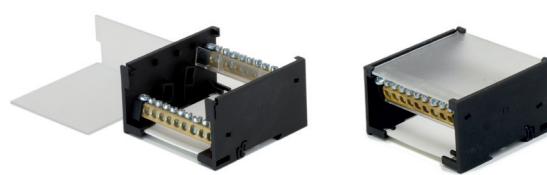

1 x 16 mm² na pól (provedení 2-pólové)
 8 x 10 mm² na pól (provedení 2-pólové)
 88 x 85 x 48 mm

CU 38023 1000V AC, 1500V DC | 80A (IEC)





1 x měděná pásovina do 20 x 10 mm
 4 x 1,5 - 25 mm² | 2 x 10 - 35 mm²
 76 x 51 x 73 mm



CU 38084 1000V AC, 1500V DC | 550A (IEC) | 600V | 310A



2-, 3- a 4-pólové kompaktní rozbočovače



-  2 x 6 – 16 mm² na pól (2-pólové provedení)
-  9 x 6 – 10 mm² na pól (2-pólové provedení)
-  126 x 93 x 48 mm







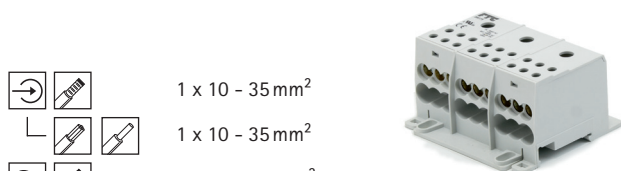

CU 38122 1000V AC, 1500V DC | 125A (IEC)



-  2 x 6 – 25 mm² na pól (2-pólové provedení)
-  7 x 6 – 10 mm² na pól (2-pólové provedení)
-  89 x 93 x 48 mm

CU 38123 1000V AC, 1500V DC | 125A (IEC)









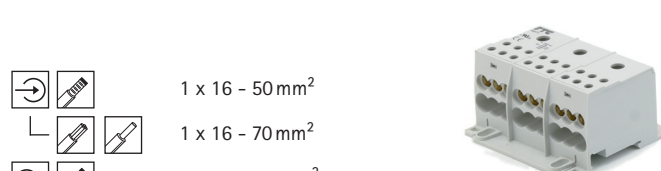

-   1 x 10 – 35 mm²
-   1 x 10 – 35 mm²
-  6 x 2,5 – 16 mm²
-   6 x 2,5 – 16 mm²
-  80 x 71,5 x 42,5 mm

CU 38075 1000V AC, 1500V DC | 125A (IEC) | 600V AC | 115A 

AL 38075AL 1000V AC, 1500V DC | 115A (IEC)





-   1 x 16 – 50 mm²
-   1 x 16 – 70 mm²
-  6 x 2,5 – 10 mm²
-   6 x 2,5 – 16 mm²
-  80 x 71,5 x 42,5 mm

CU 38073 1000V AC, 1500V DC | 175A (IEC) | 600V AC | 175A 



AL 38073AL 1000V AC, 1500V DC | 125A (IEC)



-  1 x 2,5 – 16 mm² na pól (4-pólové provedení)
-  8 x 1,5 – 10 mm² na pól (4-pólové provedení)
-  88 x 85 x 48 mm







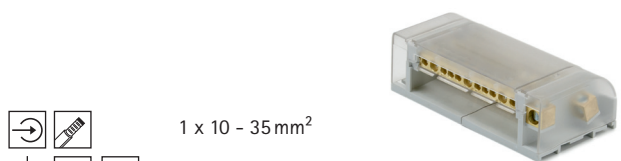

CU 38005 1000V AC, 1500V DC | 80A (IEC)



-  2 x 10 – 35 mm² na pól (4-pólové provedení)
-  10 x 2,5 – 16 mm² na pól (4-pólové provedení)
-  129 x 85 x 48 mm







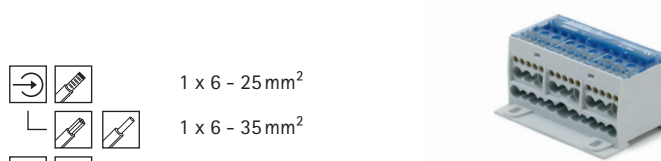

CU 38001 1000V AC, 1500V DC | 125A (IEC)



-   1 x 10 – 35 mm²
-   1 x 10 – 50 mm²
-  3 x 10 – 25 mm² | 8 x 2,5 – 16 mm²
-   3 x 10 – 35 mm² | 8 x 2,5 – 16 mm²
-  160,5 x 90 x 50 mm

CU 38027 1000V AC, 1500V DC | 160A (IEC)



-   1 x 6 – 25 mm²
-   1 x 6 – 35 mm²
-  3 póly x (5 x 1,5 – 6 mm², 2 x 4 – 10 mm², 1 x 6 – 25 mm²)
-  1 pól x (4 x 1,5 – 6 mm², 6 x 4 – 10 mm²)
-   3 póly x (5 x 1,5 – 10 mm², 2 x 4 – 16 mm², 1 x 6 – 35 mm²)
-  1 pól x (4 x 1,5 – 10 mm², 6 x 4 – 16 mm²)

CU 38056 1000V AC, 1500V DC | 125A (IEC)

4-, 5-pólové kompaktní rozbočovače



- 2 x 6 – 25 mm² na pól (4-pólové provedení)
- 2 x 6 – 35 mm² na pól (4-pólové provedení)
- 9 x 1,5 – 10 mm² | 2 x 1,5 – 16 mm² (na pól)
- 9 x 2,5 – 16 mm² | 2 x 2,5 – 16 mm² (na pól)

CU 38101 1000V AC, 1500V DC | 125A (IEC)



- 2 x 6 – 25 mm² na pól (4-pólové provedení)
- 2 x 6 – 35 mm² na pól (4-pólové provedení)
- 7 x 1,5 – 10 mm² (na pól)
- 7 x 1,5 – 16 mm² (na pól)

CU 38105 1000V AC, 1500V DC | 125A (IEC)



- 38075NPE sada**
- CU** 38075 1000V AC, 1500V DC | 125A (IEC) | 600V AC | 115A
 - N** 38074N 1000V AC, 1500V DC | 125A (IEC)
 - PE** 38074PE 1000V AC, 1500V DC | 125A (IEC)



- 38073NPE sada**
- CU** 38073 1000V AC, 1500V DC | 175A (IEC) | 600V AC | 175A
 - N** 38074N 1000V AC, 1500V DC | 175A (IEC)
 - PE** 38074PE 1000V AC, 1500V DC | 175A (IEC)



38038

Připojovací čep pro kompaktní rozbočovače

- 14,6 mm | do 250A
- 65 x 25 mm



38026

Připojovací čep pro kompaktní rozbočovače

- 18,8 mm | do 400A
- 70 x 30 mm

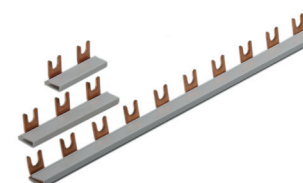

- 20 mm²
- 27 mm
- 380/2TE 2
- 3080/3TE 3
- 3080 37

Propojovací lišta pro kompaktní rozbočovače 38041

1-pólové kompaktní rozbočovače

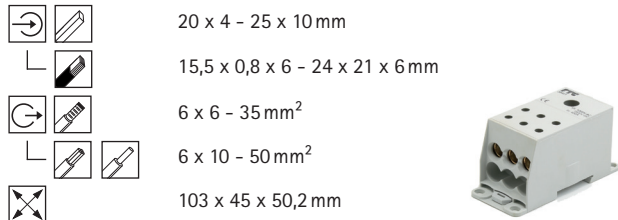

20 x 4 - 25 x 10 mm
 15,5 x 0,8 x 6 - 24 x 21 x 6 mm
 6 x 6 - 35 mm²
 6 x 10 - 50 mm²
 103 x 45 x 50,2 mm



CU	38401	1000V AC, 1500V DC 400A (IEC)
N	38401N	1000V AC, 1500V DC 400A (IEC)
PE	38401PE	1000V AC, 1500V DC 400A (IEC)
DC	38401R	1000V AC, 1500V DC 400A (IEC)

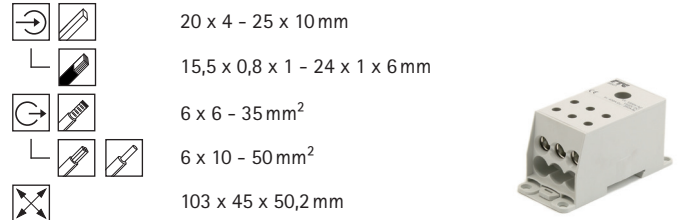

20 x 4 - 25 x 10 mm
 15,5 x 0,8 x 1 - 24 x 1 x 6 mm
 6 x 6 - 35 mm²
 6 x 10 - 50 mm²
 103 x 45 x 50,2 mm



CU	38501	1000V AC, 1500V DC 400A (IEC)
AL	38501	1000V AC, 1500V DC 350A (IEC)
N	38501N	1000V AC, 1500V DC 400A (IEC)
PE	38501PE	1000V AC, 1500V DC 400A (IEC)
DC	38501R	1000V AC, 1500V DC 400A (IEC)

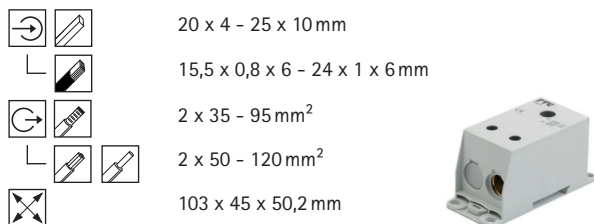

20 x 4 - 25 x 10 mm
 15,5 x 0,8 x 6 - 24 x 1 x 6 mm
 2 x 35 - 95 mm²
 2 x 50 - 120 mm²
 103 x 45 x 50,2 mm



CU	38402	1000V AC, 1500V DC 400A (IEC)
N	38402N	1000V AC, 1500V DC 400A (IEC)
PE	38402PE	1000V AC, 1500V DC 400A (IEC)
DC	38402R	1000V AC, 1500V DC 400A (IEC)

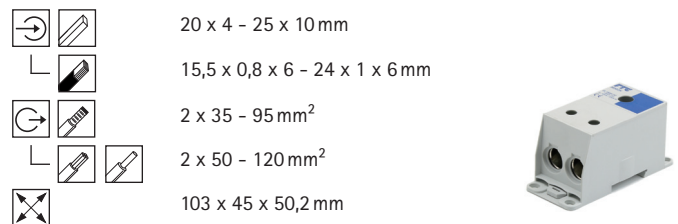

20 x 4 - 25 x 10 mm
 15,5 x 0,8 x 6 - 24 x 1 x 6 mm
 2 x 35 - 95 mm²
 2 x 50 - 120 mm²
 103 x 45 x 50,2 mm



CU	38502	1000V AC, 1500V DC 400A (IEC)
AL	38502	1000V AC, 1500V DC 350A (IEC)
N	38502N	1000V AC, 1500V DC 400A (IEC)
PE	38502PE	1000V AC, 1500V DC 400A (IEC)
DC	38502R	1000V AC, 1500V DC 400A (IEC)

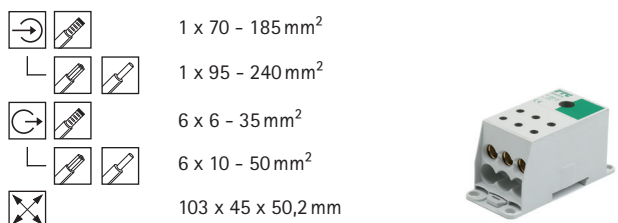

1 x 70 - 185 mm²
 1 x 95 - 240 mm²
 6 x 6 - 35 mm²
 6 x 10 - 50 mm²
 103 x 45 x 50,2 mm



CU	38403	1000V AC, 1500V DC 400A (IEC)
N	38403N	1000V AC, 1500V DC 400A (IEC)
PE	38403PE	1000V AC, 1500V DC 400A (IEC)
DC	38403R	1000V AC, 1500V DC 400A (IEC)

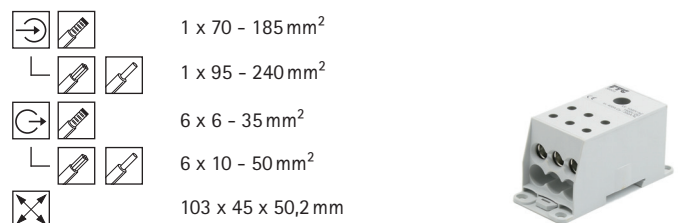





1 x 70 - 185 mm²
 1 x 95 - 240 mm²
 6 x 6 - 35 mm²
 6 x 10 - 50 mm²
 103 x 45 x 50,2 mm







CU	38503	1000V AC, 1500V DC 400A (IEC)
AL	38503	1000V AC, 1500V DC 350A (IEC)
N	38503N	1000V AC, 1500V DC 400A (IEC)
PE	38503PE	1000V AC, 1500V DC 400A (IEC)
DC	38503R	1000V AC, 1500V DC 400A (IEC)

1-pólové kompaktní rozbočovače

	1 x 70 - 185 mm ²
	1 x 95 - 240 mm ²
	2 x 35 - 95 mm ²
	2 x 50 - 120 mm ²
	103 x 45 x 50,2 mm







CU	38404	1000V AC, 1500V DC 400A (IEC)
N	38404N	1000V AC, 1500V DC 400A (IEC)
PE	38404PE	1000V AC, 1500V DC 400A (IEC)
DC	38404R	1000V AC, 1500V DC 400A (IEC)

	1 x 70 - 185 mm ²
	1 x 95 - 240 mm ²
	2 x 35 - 95 mm ²
	2 x 50 - 120 mm ²
	103 x 45 x 50,2 mm







CU	38504	1000V AC, 1500V DC 400A (IEC)
AL	38504	1000V AC, 1500V DC 350A (IEC)
N	38504N	1000V AC, 1500V DC 400A (IEC)
PE	38504PE	1000V AC, 1500V DC 400A (IEC)
DC	38504R	1000V AC, 1500V DC 400A (IEC)

	1 x 16 - 185 mm ²
	1 x 16 - 240 mm ²
	1 x 16 - 185 mm ²
	1 x 16 - 240 mm ²
	145 x 40 x 80 mm

















CU	38057	1000V AC, 1500V DC 400A (IEC) 600V AC 335A 
AL	38057	1000V AC, 1500V DC 300A (IEC)

	2 x 16 - 240 mm ²
	2 x 25 - 300 mm ²
	2 x 16 - 240 mm ²
	2 x 25 - 300 mm ²
	145 x 72 x 80 mm



CU	38059	1000V AC, 1500V DC 800A (IEC) 600V AC 600A 
AL	38059	1000V AC, 1500V DC 630A (IEC)

	vstup
	výstup
	rozměry
	sběrnice
	lamelový vodič
	jednodrátový vodič
	slaněný vodič
	jemný slaněný vodič s dutinkou
	rozteč
	průřez
	připojovací praporce
	sada sestávající z více výrobků

CU	vhodné pro měděné vodiče
AL	vhodné pro hliníkové a měděné vodiče
N	modrý potisk
PE	zelený potisk
DC	červený potisk
	UL certifikace USR + CSA
	UL certifikace USR + CNR



EROCOMM s.r.o.
Dřevčice 141
tel.: +420 326 910 950
www.ero-comm.cz
info@ero-comm.cz



EROCOMM SK s.r.o.
Koprivnická 36
841 02 Bratislava
tel./fax: +421 264 462 480
www.ero-comm.sk
info@ero-comm.sk

