



**STREET TO STRIP, WE'VE GOT YOU COVERED!**

One-Stop Shop Factory-Backed Performance Parts for All Things Dodge

# 2022 CATALOG





# RESURRECTION

In 1974, Direct Connection was the first to offer factory performance parts to racers and muscle car enthusiasts.



The return of Direct Connection will once again change the game...



Setting the story straight with factory-tuned upgrades to maximize your vehicle's performance potential.

- Factory-backed and engineered performance parts for all things Dodge
- Dedicated Direct Connection eStore and Dodge Power Brokers dealer network
- Direct Connection Technical Hotline for all of your performance questions and needs

# FACTORY BACKED. OEM TRUSTED.

Direct Connection is committed to delivering the highest quality, most trusted performance parts on the market. Nowhere else will you find components that were designed and built specifically for your vehicle by the very same engineers who developed and tested our cars. With Direct Connection Performance Parts, you spend less time trying to perfect your set-up and more time winning at the track. This catalog was built to showcase the upgrade opportunities that are available for your Dodge vehicle.



Get technical answers on Direct Connection performance parts, motorsports guidelines and more. Call the Direct Connection Technical Hotline at 800-998-1110. (Available Mon-Fri 8am – 6pm; Sat 8am - 5pm Eastern)







### THE GOLDEN ERA

During the golden era of muscle cars, Direct Connection was the Mopar® brand's answer to the sensational demand for factory-backed performance parts and technical information among racing and street performance enthusiasts alike. By offering factory-engineered, race-proven parts, and a massive portfolio of ready-to-run performance parts with how-to performance upgrade guides, Direct Connection earned its place in history as what customers needed to win at the track.



### DIRECT CONNECTION PROMISE

Direct Connection is your one-stop shop for factory-backed performance parts for street and race performance vehicles developed and manufactured to the same standards set by SRT® Engineering. Offering exclusive, OEM-backed performance products via an online shopping website and providing the highest level of performance parts knowledge and technical expertise straight from the OEM, Direct Connection will ensure enthusiasts achieve their ultimate performance goals and continue to keep the competition in the rearview mirror.



2022

### BACK WITH A VENGEANCE

Just as it did in 1974, the return of Direct Connection will once again change the game. Offering factory-backed, ready-to-run performance parts and technical information straight from the same SRT engineers who introduced record-breaking vehicles, such as the SRT Hellcat Redeye. Direct Connection helps you win while saving you time and money by eliminating the common guesswork associated with high-performance upgrades. From modern performance vehicles, drag racing and resto-mods to vintage vehicles, Direct Connection has you covered.



**HUSTLE STUFF**  
IS HERE!

1970-1971

Chrysler increases support of street/strip performance enthusiasts through the creation of "Hustle Stuff," offering everything from dedicated racing parts to cool dress-up parts.

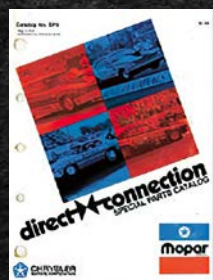

1974

Chrysler forms Direct Connection featuring a massive portfolio of high-performance parts specifically designed and engineered for Mopar vehicles. This catalog also contains "speed recipes" for specific ET and MPH bracket racing goals. Direct Connection becomes the benchmark of the industry.



1975-1980

Direct Connection expands to include circle track and off-road parts. The infamous "P" prefix on part numbers is assigned to performance parts. A 1,400-page racing manual written by Chrysler's performance engineers for modifying the engine, transmission, chassis and suspension becomes known as "The Bible" by enthusiasts.



1980-1986

Direct Connection adapts to changing consumer interests by offering superchargers, turbochargers and more for 2.2L four-cylinder Chrysler engines.



1987-2021

With a redirection on performance parts and a revised brand strategy, Direct Connection becomes Mopar Performance, ushering in a new era of modern performance parts and high-performance crate engines.







## Tips on Parts for the Hemi Engine Bracket Racer

Bracket racers will find these tips helpful in selecting the most advantageous parts from a cost and performance standpoint. They were developed by Chrysler performance engineers and represent combinations of compatible parts best suited for given performance levels. Tips take into consideration engine, drivetrain and chassis parts. For more detailed information please consult Racing Bulletin #10 or the Performance Book (P4120792).

### 426 HEMI ENGINE 13 Sec. Bracket

#### Engine Package A

Complete Bulletin Book P4120792  
Electronic Ignition Kit P3690428  
Set timing to 35° total — using timing tape P4007657  
High performance — valve job  
Centerline cam using bushing kit P3690936  
Solid Core Plug Wires P4120716  
Use with (8) P3690802 boots  
Chrome Timing Chain Cover P4120224

#### Chassis Package A

Front End Alignment Zero Toe-In  
Tire Pressure  
36 psi front  
32-36 psi rear std. tires  
8-16 psi slicks  
Torque strap — man. trans.  
Gear 4.10:1  
Sure Grip  
Tires 9" x 29.5" Slicks  
Rear Spring Clamp P4120470

### 426 HEMI ENGINE 12 Sec. Bracket

#### Engine Package B

Same as Engine Package A except for the following items:  
Headers & Collectors  
SSH-44 Cam P3690814  
Valve Springs P3690933  
Electric Fuel Pump P4007038

#### Chassis Package B

Same as Chassis Package A plus:  
Deep Trans. Pan P3690730  
H.P. clutch 10½" Man. P3515678  
Good Shifter — Man. & Auto.  
Super Stock Springs & Hangers  
Gear 4.56:1  
Tires — 11" x 30" slicks  
Long Shocks  
Ft. Strut Bushing Pkg. P4120214  
3" Front Wheel Stud Set P4120610  
3" Rear Wheel Stud Set P4120625



## Performance Formulas for the Dodge Challenger and Charger Bracket Racer

These part tips will give Challenger bracket racers the perfect formulas for ultimate performance. They were developed and tested by SRT® engineers and Dodge drag racers and represent the most optimal set-up to achieve success on the track. The Dodge Challenger SRT Hellcat Redeye is capable of running an 11.1-sec. quarter-mile and the following performance formulas will give the car what it needs to enter the 9-sec. bracket.

### Level 1 Performance

Mid 10-sec. Bracket

Redeye Pre-stage Kit (P/N: 77072579AB, Pg. 46)

Redeye Stage I Kit (P/N: 77072581AB, Pg. 47)

305 Drag Radial Tires Tire Pressure

Front—40 psi

Rear—18-24 psi

### Level 2 Performance

9-sec. Bracket

Redeye Pre-stage Kit (P/N: 77072579AB, Pg. 46)

Redeye Stage II Kit (P/N: 77072583AB, Pg. 47)

Widebody Fender Flare Kit (P/N: 77072552AB, Pg. 60)

Challenger Widebody Wheel (P/N: 6CT34MALAC)

315 Drag Radial Tires Tire Pressure

Front—40 psi

Rear—18-24 psi



# How to build a 13-sec. bracket racer.

You don't have to have a fuel dragster to experience the thrill of competition. In fact, you can build a fast bracket racer for not a lot of money—with a Dart, Aspen or Duster, a little wrench-work and Direct

Connection performance parts. The Engine and Chassis Books that you can order from Direct Connection give you all the details on race-prepping your own bracket racer for serious drag competition.

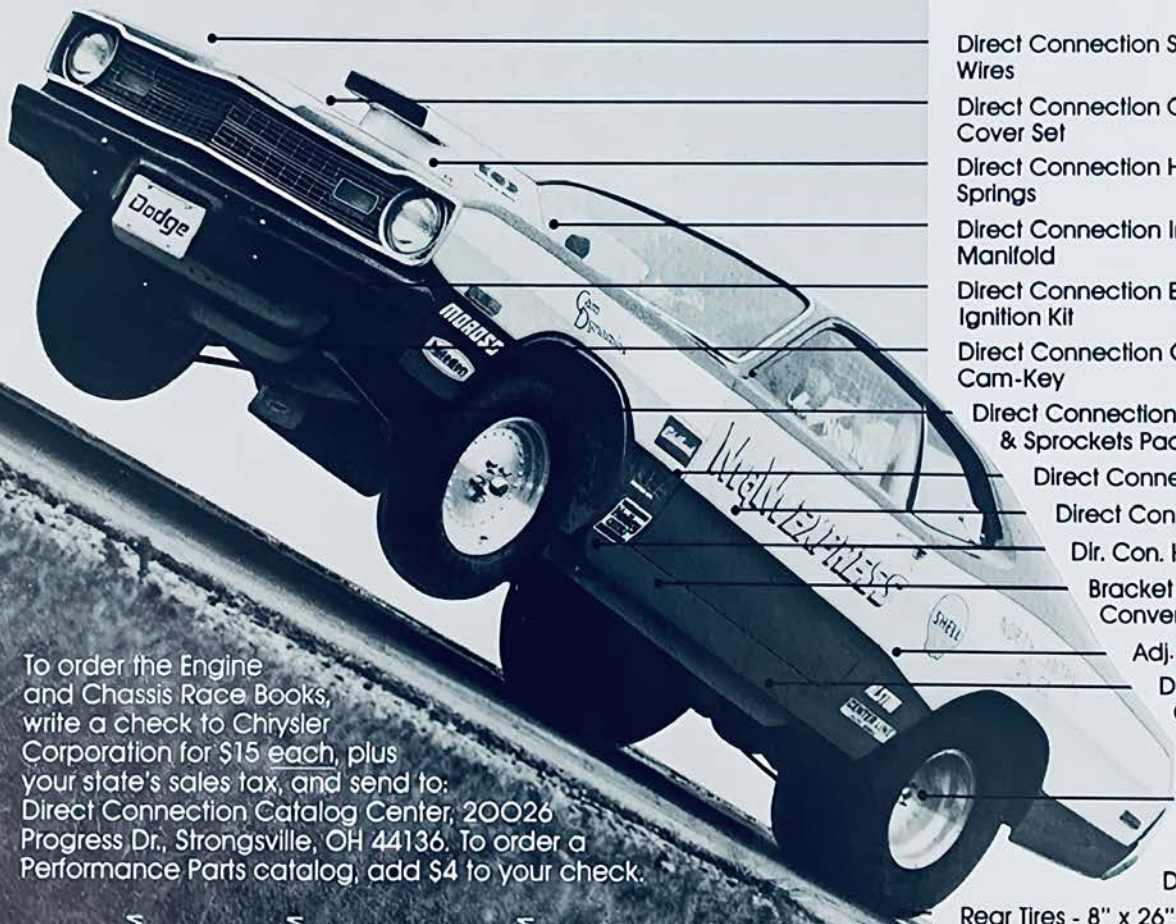

- Direct Connection Solid Core Plug Wires
- Direct Connection Chrome Valve Cover Set
- Direct Connection H.D. Valve Springs
- Direct Connection Intake Manifold
- Direct Connection Electronic Ignition Kit
- Direct Connection Offset Cam-Key
- Direct Connection Roller Chain & Sprockets Package
- Direct Connection Camshaft
- Direct Connection Gauges
- Dir. Con. Headers
- Bracket Torque Converter or H.P. Clutch
- Adj. Pinion Snubber
- Direct Connection Competition Axle Ratio
- Direct Connection Sure Grip Differential
- Rear Tires - 8" x 26" Slicks

To order the Engine and Chassis Race Books, write a check to Chrysler Corporation for \$15 each, plus your state's sales tax, and send to: Direct Connection Catalog Center, 20026 Progress Dr., Strongsville, OH 44136. To order a Performance Parts catalog, add \$4 to your check.

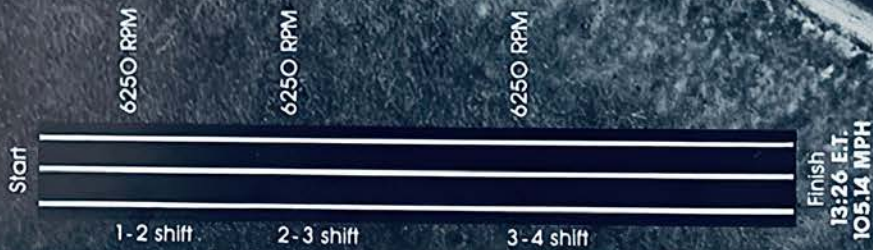

**direct connection**



# HOW TO BUILD A 10-SEC. BRACKET RACER.

## LEAH PRUETT

- NHRA Top Fuel driver for Tony Stewart Racing
- Nine times Top Fuel national winner
- Got her start in the sport in the NHRA Summit Racing Jr. Drag Racing League at age eight
- Captured the 2000 and 2001 Jr. Dragster division 7 championships
- Won the 2010 NHRA Hot Rod Heritage Racing Series (Funny Car)
- Competed in NHRA Pro Mod Series and has three career wins in the category
- The 2018 Factory Stock Showdown crown in a Dodge Drag Pak is the fourth title for Pruett
- By securing the Factory Stock title, Pruett was the only professional driver to contend for two world titles during the 2018 NHRA season
- Leah set a track record on Nov 1, 2019. She went 3.654 at 329.83 mph at the Dodge NHRA Nationals presented by Pennzoil at The Strip at Las Vegas Motor Speedway in Las Vegas, Nevada.

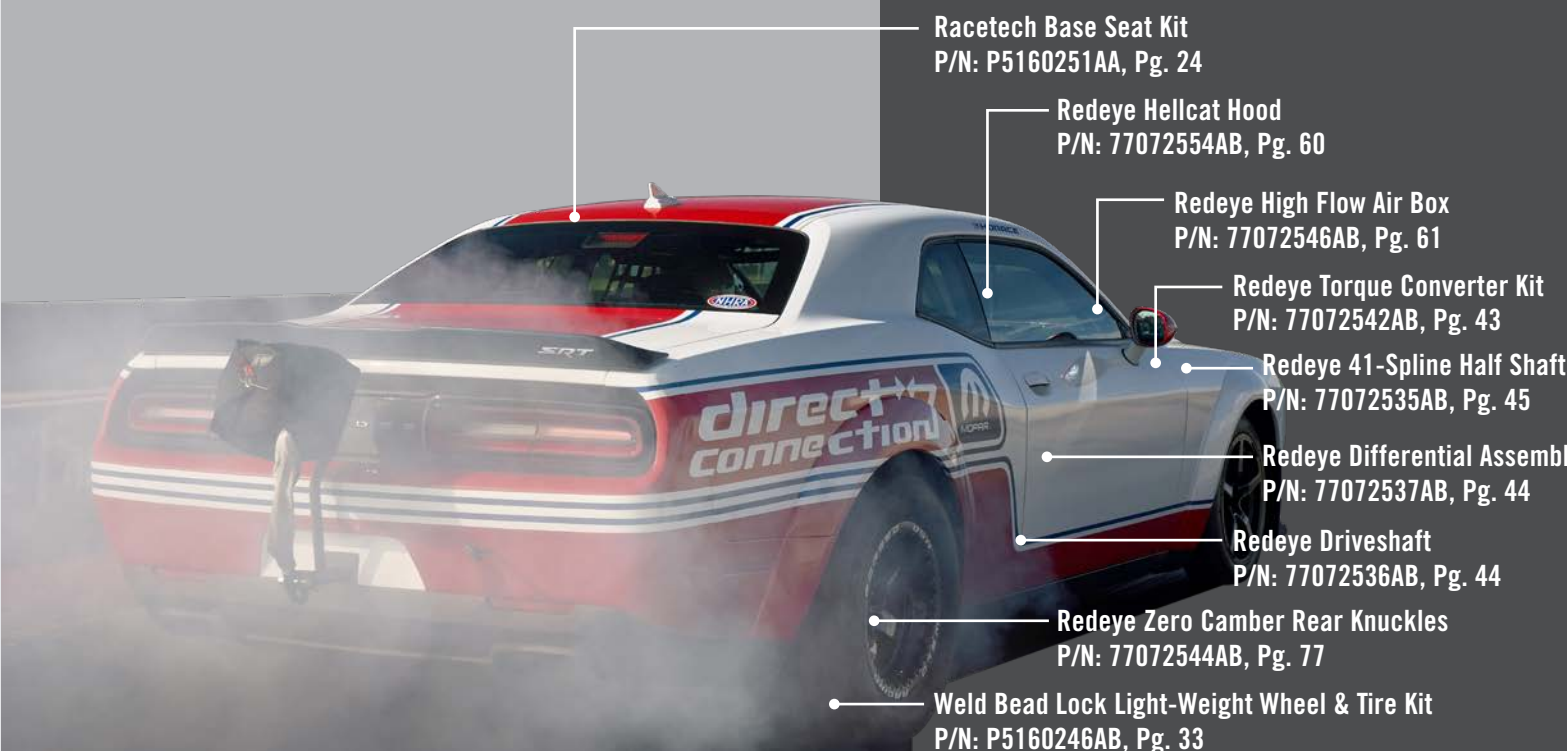

- Racetech Base Seat Kit  
P/N: P5160251AA, Pg. 24
- Redeye Hellcat Hood  
P/N: 77072554AB, Pg. 60
- Redeye High Flow Air Box  
P/N: 77072546AB, Pg. 61
- Redeye Torque Converter Kit  
P/N: 77072542AB, Pg. 43
- Redeye 41-Spline Half Shafts  
P/N: 77072535AB, Pg. 45
- Redeye Differential Assembly  
P/N: 77072537AB, Pg. 44
- Redeye Driveshaft  
P/N: 77072536AB, Pg. 44
- Redeye Zero Camber Rear Knuckles  
P/N: 77072544AB, Pg. 77
- Weld Bead Lock Light-Weight Wheel & Tire Kit  
P/N: P5160246AB, Pg. 33





# PERFORMANCE WARRANTY

## WE'VE GOT YOUR BACK.

You can feel confident pushing your car to the limit because we've got your back. Direct Connection Performance Parts are backed by our 24-month UNLIMITED-mile warranty or maintain your vehicle warranty coverage if installed by an authorized Direct Connection dealer! Terms and conditions apply.



### Performance Parts

- 24 months UNLIMITED miles
- Vehicle Warranty Coverage:
- 3 years or 36k miles (vehicle)
- 5 years or 60k miles (engine & driveline)



### Crate Engines with Installation Kit

- 36 months or 100k miles
- Parts exchange only



### Crate Transmissions

- 12 months or 12k miles

For more warranty coverage details, refer to page 108.



# TABLE OF CONTENTS

<b>CRATE ENGINES</b>	2
Crate Engines and Stage Kits	7
Transmissions	10
Engine Controllers	13
Crate Engine Accessories	17
Exhaust	17
Engine Oiling & Parts	17
Front End Accessory Drive (FEAD) Kits	18
<b>DRAG PAK RACE KITS</b>	20
Engines	21
Driveline	22
Engine Cooling	23
Body & Aero	23
Interior	24
2021 Dodge Challenger Mopar® Drag Pak	26
Engine Electrical & Controllers	28
Suspension Upgrades	32
Wheels & Tires	33
Graphics Packages	36
<b>MODERN PERFORMANCE</b>	40
Brakes	42
Drivetrain	43
Engine Parts	46
Exhaust	54
Exterior	60
Intake & Air	61
Interior Accessories	74
Suspension	77
Wheels	83
<b>VINTAGE MUSCLE</b>	84
Air & Fuel	86
Brakes	87
Drivetrain	88
Engine Parts	90
Covers & Hardware	90
Engine Cooling	91
Engine Electrical & Controllers	91
Gaskets & Hardware	93
Oiling Systems & Parts	97
Valvetrain & Cylinder Heads	101
Exterior	104
Suspension	104
<b>WARRANTY</b>	108

### U.S., CANADA, CALIFORNIA AND LOCAL EMISSION REQUIREMENTS

Please be advised that the removal of or tampering with production vehicles components designed to meet emission requirements or to comply with motor vehicle safety regulations, as well as the installation of a part that renders a production vehicle non-compliant with U.S., California, Canadian, or local emissions standards, and operating such a vehicle on-road, is prohibited and illegal.



### STREET LEGAL PERFORMANCE PARTS

As a manufacturer of performance parts, Direct Connection recognizes a special responsibility regarding environmental concerns. Direct Connection is committed to a program of performance parts development that allows motorsport enthusiasts to modify their vehicles and still comply with emission requirements. Consistent with regulations established by the State of California applicable to aftermarket parts installed on vehicles driven on public roads, the installation on a production vehicle of any performance part listed in this catalog that is labeled with the "50-States Street Legal" logo can be driven on public roads. Because Direct Connection has demonstrated to the State of California that an emissions-compliant vehicle on which such "50-States Street Legal" parts are installed remains emissions compliant, the State of California deems such vehicle "Street Legal" and has issued an emissions compliance-certifying Executive Order for such parts.



### COMPETITION USE PARTS

This catalog also lists performance parts that are designed for track, off-road, or off-road competitive performance use only, because their use on production vehicles renders the on-road operation of such vehicles non-compliant with the above-referenced emissions regulations. The State of California deems vehicles equipped with these off-road parts "not Street Legal." In this catalog, Direct Connection labels such parts with a special "Checkered Flag" logo.

### DISCLAIMERS

Many of the parts in this catalog have been designed and are intended for off-road application only. Driving a vehicle on public roads after having these parts installed violates U.S., California, Canadian, Provincial, and local laws and regulations relating to emission requirements and motor vehicle safety standards. In addition, installation of these parts may adversely affect the warranty coverage on your vehicle. Direct Connection customers are responsible for ensuring that their use of their vehicle equipped with such off-road parts complies with applicable federal, state/provincial, and local laws, regulations and ordinances.

Prices shown are MSRP and do not include installation or taxes. Actual price of item is determined by the dealer and may vary from price shown. Actual product and availability may vary.

For more information, call the Direct Connection Tech Hotline at (800) 998-1110.



# READY. TO. DOMINATE.

For over 80 years, our team has been engineering, developing and producing OEM-quality performance upgrades so that you can dominate at the strip and on the street. No matter what your performance upgrade goal is, we've got you covered! We're excited to offer a full lineup of crate engines that will be sure to leave you glued to your seat regardless of the application.

**HELLEPHANT 426  
SUPERCHARGED CRATE HEMI® ENGINE**  
1,000 HP | 950 LB.-FT. TORQUE



## CRATE ENGINES

CRATE ENGINES

**HELLCRATE REDEYE 6.2L  
SUPERCHARGED CRATE HEMI® ENGINE**  
807 HP | 717 LB.-FT. TORQUE



**HELLCRATE 6.2L  
SUPERCHARGED CRATE  
HEMI® ENGINE**  
717 HP | 656 LB.-FT. TORQUE



**HELLCRATE REDEYE 6.2L  
SUPERCHARGED CRATE HEMI® ENGINE**  
807 HP | 717 LB.-FT. TORQUE



**345 CRATE HEMI® ENGINE**  
383 HP | 417 LB.-FT. TORQUE



**392 CRATE HEMI® ENGINE**  
485 HP | 475 LB.-FT. TORQUE



### *Power. Unleashed.*

Looking for legendary power? You're in the right place. The Gen III HEMI® engine combines state-of-the-art technology with the free-flowing cylinder head design from the original 426 HEMI engine to deliver the raw horsepower, epic torque and adrenaline-pumping sound that you've always wanted. From crate engines to bolt-on parts, Direct Connection is ready to take your car to the next level — and beyond.



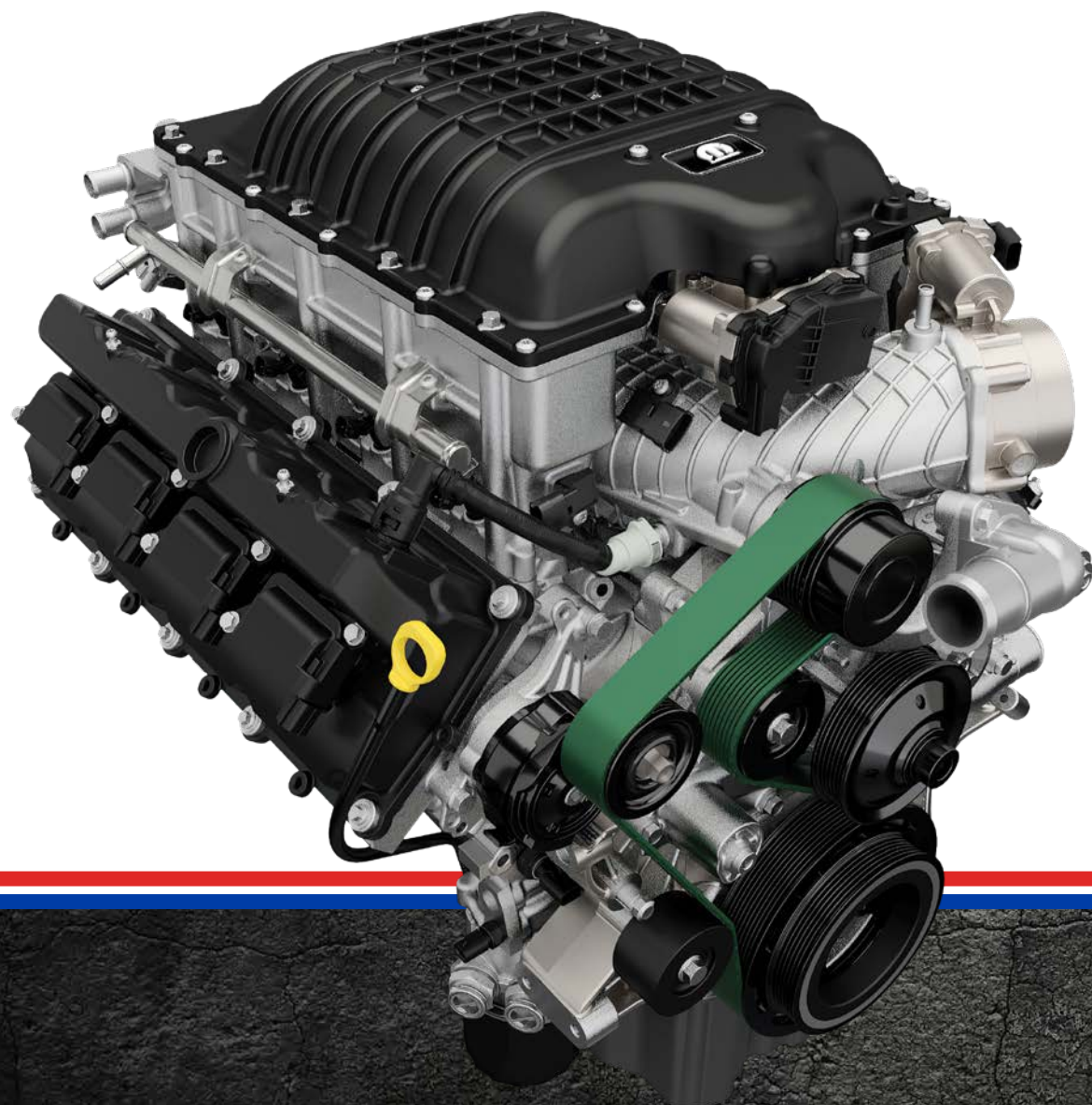

## Hellephant 426 Supercharged Crate HEMI® Engine<sup>1</sup>

Boasting 1,000 hp and 950 lb.-ft. of torque, the Hellephant 426 Supercharged Crate HEMI® engine represents the game-changing performance in crate engines. This masterpiece can be dropped into any pre-1976 vehicle when paired with the “plug and play” engine kit.

### FEATURES:

- Engine type 426 Supercharged Crate HEMI engine
- Displacement 426 cu. in.
- Bore 4.125 in.
- Stroke 4.0 in.
- Block cast aluminum with 4-bolt powder metal caps
- Crank material forged steel
- Connecting rods forged 4340 H-beam with ARP 2000 bolts
- Piston material forged aluminum
- Camshaft nodular iron camshaft valve/lift duration @ 0.15 mm
- Cylinder heads aluminum, HEMIspherical chamber cylinder heads
- 54.3 mm intake valve size
- 42 mm exhaust valve size
- 9.5:1 compression ratio
- 6800 peak RPM
- Recommended fuel premium

P/N: P5160194AC

Price: \$29,995.00

Warranty: No warranty, sold as-is

<sup>1</sup>CRATE HEMI ENGINES ARE DESIGNED FOR INSTALLATION IN: 1. ANY MOTOR VEHICLE MANUFACTURED PRIOR TO MODEL YEAR 1976 OR 2. COMPETITION VEHICLES DRIVEN ON TRACKS OR OFF-ROAD. Vehicles manufactured 1976 and later equipped with this part should not be driven on public roads or highways. Direct Connection customers are responsible for ensuring that their use of their vehicle equipped with this part complies with applicable federal, state/provincial and local laws, regulations and ordinances. Vehicles manufactured 1976 and later equipped with this part and driven on public roads or highways may violate U.S., California, Canadian or local motor vehicle emissions laws and regulations.

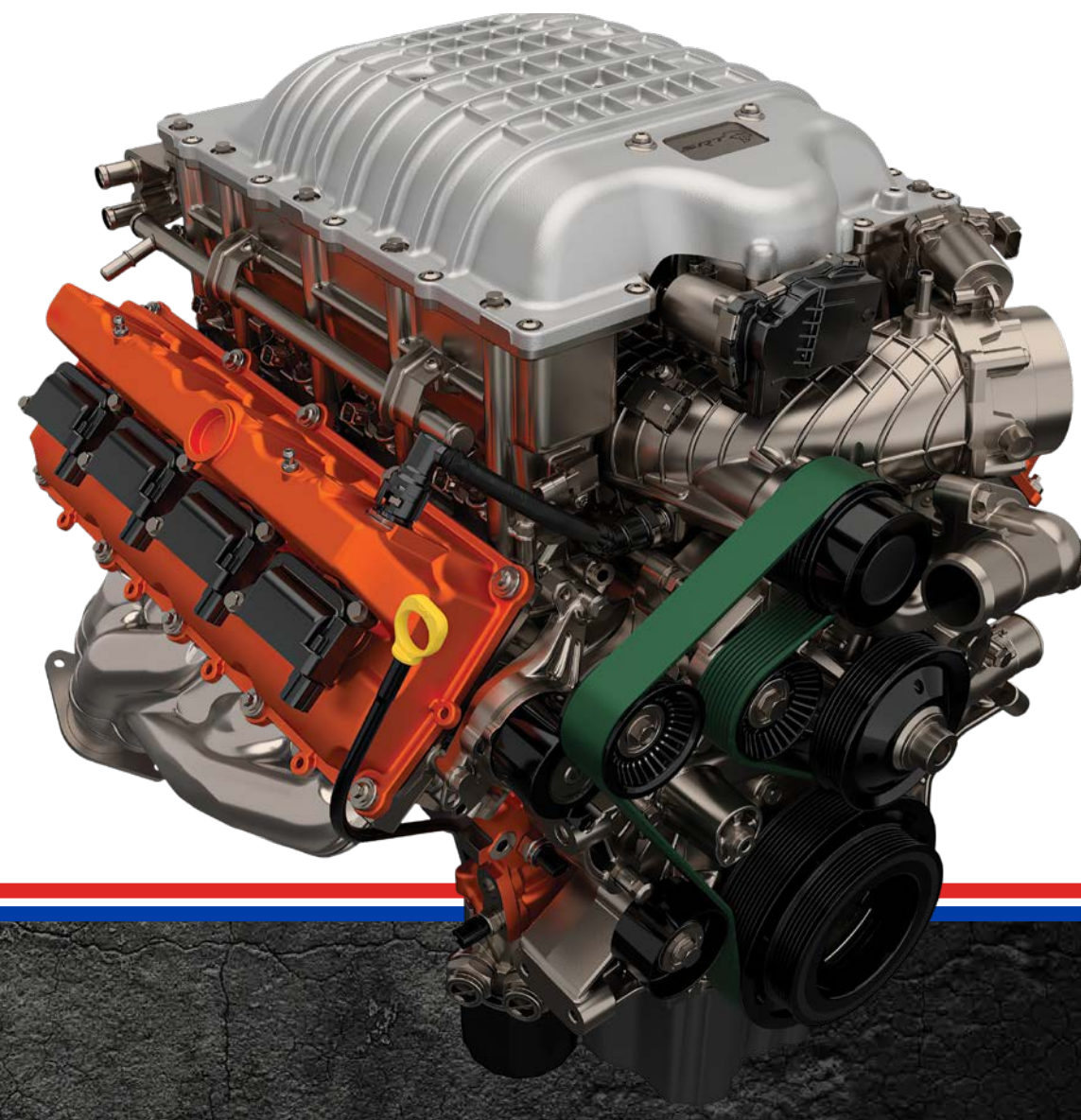

## Hellcrate 6.2L Supercharged Crate HEMI® Engine<sup>1</sup>

You've asked for it and Direct Connection delivered. The Hellcrate 6.2L Supercharged Crate HEMI® engine exerts a monstrous 717 hp and 656 lb.-ft. of torque. This complete engine assembly includes a water pump, flywheel and clutch, front sump oil pan, intake manifold with throttle body, fuel injectors and coil packs.

### FEATURES:

- 376 cu. in.
- 103.9 mm bore
- 90.9 mm stroke
- Cast iron block with 4-bolt powder metal main caps
- Forged steel crank material
- Connecting rods and floating pins with diamond-like coating
- Forged piston material
- Nodular iron camshaft
- Valve/lift duration @ 0.15 mm. Int: 14.25 (0.561) mm – 278 deg. Hollow stems, Exh: 14.0 (0.551) mm – 304 deg. Sodium-filled stems
- 356 aluminum, HEMIspherical chamber cylinder heads
- 54.3 mm intake valve size
- 42 mm exhaust valve size
- 9.5:1 compression ratio
- 6,200 max RPM

P/N: 68303089AB

Price: \$17,925.00

Warranty:  must purchase crate engine w/engine controller kit (P/N: 77072452AE)

<sup>1</sup>CRATE HEMI ENGINES ARE DESIGNED FOR INSTALLATION IN: 1. ANY MOTOR VEHICLE MANUFACTURED PRIOR TO MODEL YEAR 1976 OR 2. COMPETITION VEHICLES DRIVEN ON TRACKS OR OFF-ROAD. Vehicles manufactured 1976 and later equipped with this part should not be driven on public roads or highways. Direct Connection customers are responsible for ensuring that their use of their vehicle equipped with this part complies with applicable federal, state/provincial and local laws, regulations and ordinances. Vehicles manufactured 1976 and later equipped with this part and driven on public roads or highways may violate U.S., California, Canadian or local motor vehicle emissions laws and regulations.



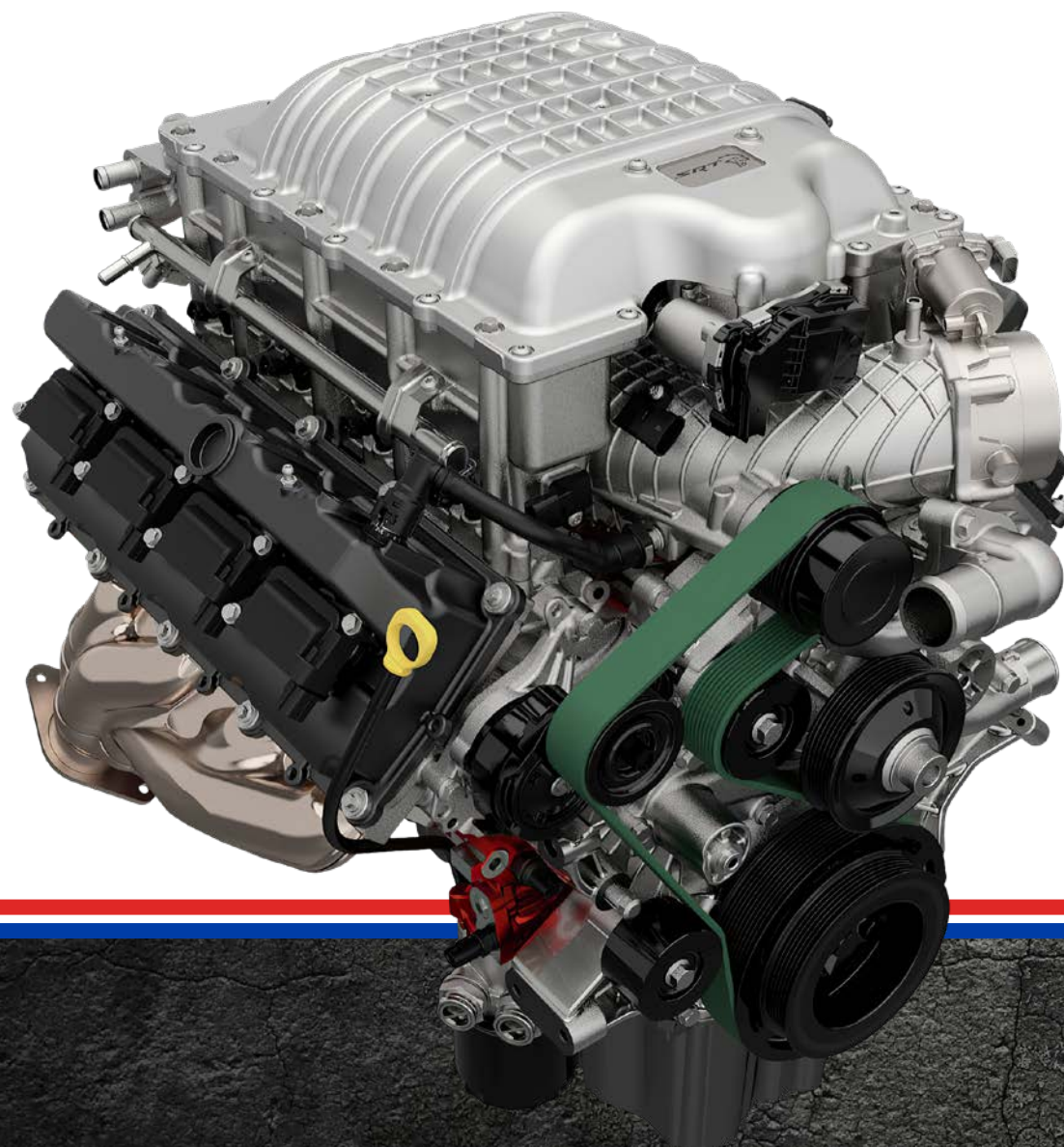

## Hellcrate Redeye 6.2L Supercharged Crate HEMI® Engine<sup>1</sup>

The Hellcrate Redeye 6.2L Supercharged Crate HEMI® engine with 807 hp and 717 lb.-ft. of torque. This complete engine assembly includes a water pump, flywheel and clutch, front sump oil pan, intake manifold with throttle body, fuel injectors and coil packs.

### FEATURES:

- Engine type GEN III HEMI V8
- 2.7L supercharger
- Displacement 376 cu. in.
- Bore 103.9 in.
- Stroke 90.9 in.
- Block cast iron block with 4-bolt powder metal caps
- Crank material forged alloy steel
- Connecting rods forged powder metal connecting rods with diamond-like coating wrist pins

P/N: 68303091AA

Price: \$20,795.00

Warranty:  must purchase crate engine w/engine controller kit (P/N: 77072601AA)

- Piston material forged high-strength alloy
- Cylinder heads 356 aluminum, HEMIspherical combustion chamber cylinder heads
- 54.3 mm intake valve size
- 42 mm exhaust valve size
- 9.5:1 compression ratio
- 6500 peak RPM
- Recommended fuel premium

<sup>1</sup>CRATE HEMI ENGINES ARE DESIGNED FOR INSTALLATION IN: 1. ANY MOTOR VEHICLE MANUFACTURED PRIOR TO MODEL YEAR 1976 OR 2. COMPETITION VEHICLES DRIVEN ON TRACKS OR OFF-ROAD. Vehicles manufactured 1976 and later equipped with this part should not be driven on public roads or highways. Direct Connection customers are responsible for ensuring that their use of their vehicle equipped with this part complies with applicable federal, state/provincial and local laws, regulations and ordinances. Vehicles manufactured 1976 and later equipped with this part and driven on public roads or highways may violate U.S., California, Canadian or local motor vehicle emissions laws and regulations.

# STAGE KITS

## Hellcrate Redeye Stage I Kit

For the Hellcrate Redeye Crate Engine Assembly, increase your engine performance to TBD at the touch of a button when used in conjunction with the Direct Connection Tuner Kit — no tools required. Includes high-performance calibration key code which unlocks Stage I calibration. TBD hp is achieved by enabling high-octane functionality<sup>1</sup> via touchscreen device.

Turn-key hp upgrade for Redeye

- Increased engine performance to TBD
- Enables similar high-octane functionality<sup>1</sup> as a Challenger SRT® Demon
- Works in conjunction with touchscreen device
- Performance Warranty

P/N: TBD

Price: Late Availability

Warranty: 



## STAGE I



## Hellcrate Redeye Stage II Kit

For the Hellcrate Redeye Crate Engine Assembly, increase your engine performance to TBD hp at the touch of a button when used in conjunction with the Direct Connection Tuner Kit. Includes Hellephant pulley (80.5 mm/3.17" dia) and high-performance calibration key code, which unlocks Stage II calibration. TBD hp is achieved by enabling high-octane functionality<sup>1</sup> via touchscreen device. Note: While high-octane mode is not engaged, expected performance is TBD.

Turn-key hp upgrade for Redeye

- Increased engine performance to TBD
- Enables similar high-octane functionality<sup>1</sup> as a Challenger SRT Demon
- 3.17 in. Hellephant Pulley
- Works in conjunction with touchscreen device
- Performance Warranty

\*Must have Direct Connection Hellcrate Redeye Stage I kit - Pg. 7

P/N: TBD

Price: Late Availability

Warranty: 



\*DC Stage 1 Kit Not included

## STAGE II



<sup>1</sup>CRATE HEMI ENGINES ARE DESIGNED FOR INSTALLATION IN: 1. ANY MOTOR VEHICLE MANUFACTURED PRIOR TO MODEL YEAR 1976 OR 2. COMPETITION VEHICLES DRIVEN ON TRACKS OR OFF-ROAD. Vehicles manufactured 1976 and later equipped with this part should not be driven on public roads or highways. Direct Connection customers are responsible for ensuring that their use of their vehicle equipped with this part complies with applicable federal, state/provincial and local laws, regulations and ordinances. Vehicles manufactured 1976 and later equipped with this part and driven on public roads or highways may violate U.S., California, Canadian or local motor vehicle emissions laws and regulations.

HOTLINE # 800-998-1110 (MON – FRI 8AM – 6PM; SAT 8AM – 5PM EASTERN)



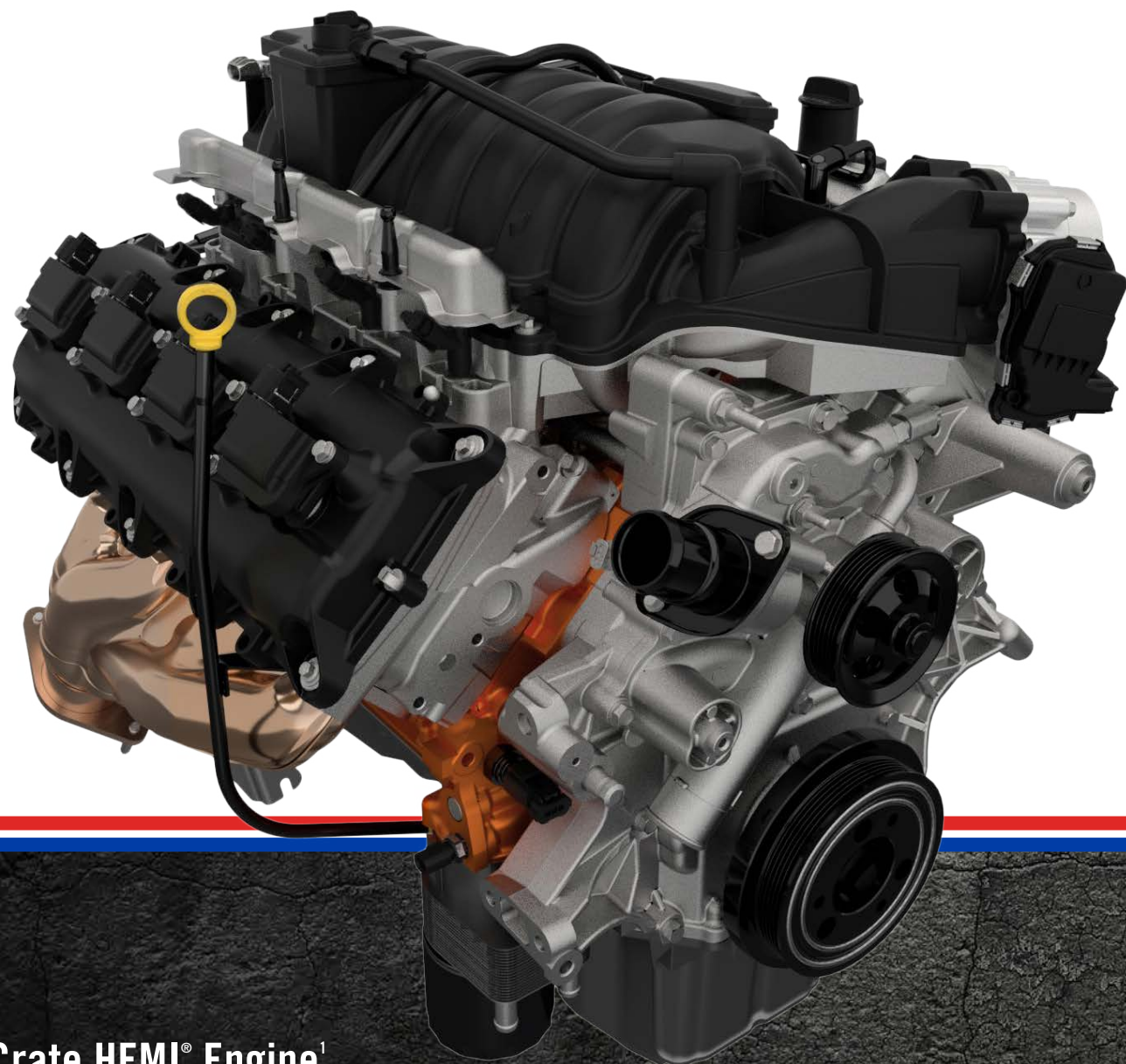

## 392 Crate HEMI® Engine<sup>1</sup>

Step up to the next level of performance with the 392 Crate HEMI® engine. With 485 hp and 475 lb.-ft. of torque, this complete engine assembly includes a water pump, flywheel and clutch, front sump oil pan, intake manifold with throttle body, fuel injectors and coil packs.

### FEATURES:

- 392 cu. in.
- 103.9 mm Bore
- 94.6 mm Stroke
- Cast iron block with 4-bolt powder metal caps
- Forged steel crank material
- Powdered metal, floating pin connecting rods

- 6,400 peak RPM
- Hypereutectic aluminum piston material
- Nodular iron camshaft
- Aluminum, HEMIspherical chamber cylinder heads
- 54.3 mm intake valve size
- 42 mm exhaust valve size
- 10.9:1 compression ratio

P/N: 68303090AB

Price: \$9,600.00

Warranty:  must purchase crate engine w/engine controller kit (P/N: 77072454AH or 77072451AG)

<sup>1</sup>CRATE HEMI ENGINES ARE DESIGNED FOR INSTALLATION IN: 1. ANY MOTOR VEHICLE MANUFACTURED PRIOR TO MODEL YEAR 1976 OR 2. COMPETITION VEHICLES DRIVEN ON TRACKS OR OFF-ROAD. Vehicles manufactured 1976 and later equipped with this part should not be driven on public roads or highways. Direct Connection customers are responsible for ensuring that their use of their vehicle equipped with this part complies with applicable federal, state/provincial and local laws, regulations and ordinances. Vehicles manufactured 1976 and later equipped with this part and driven on public roads or highways may violate U.S., California, Canadian or local motor vehicle emissions laws and regulations.

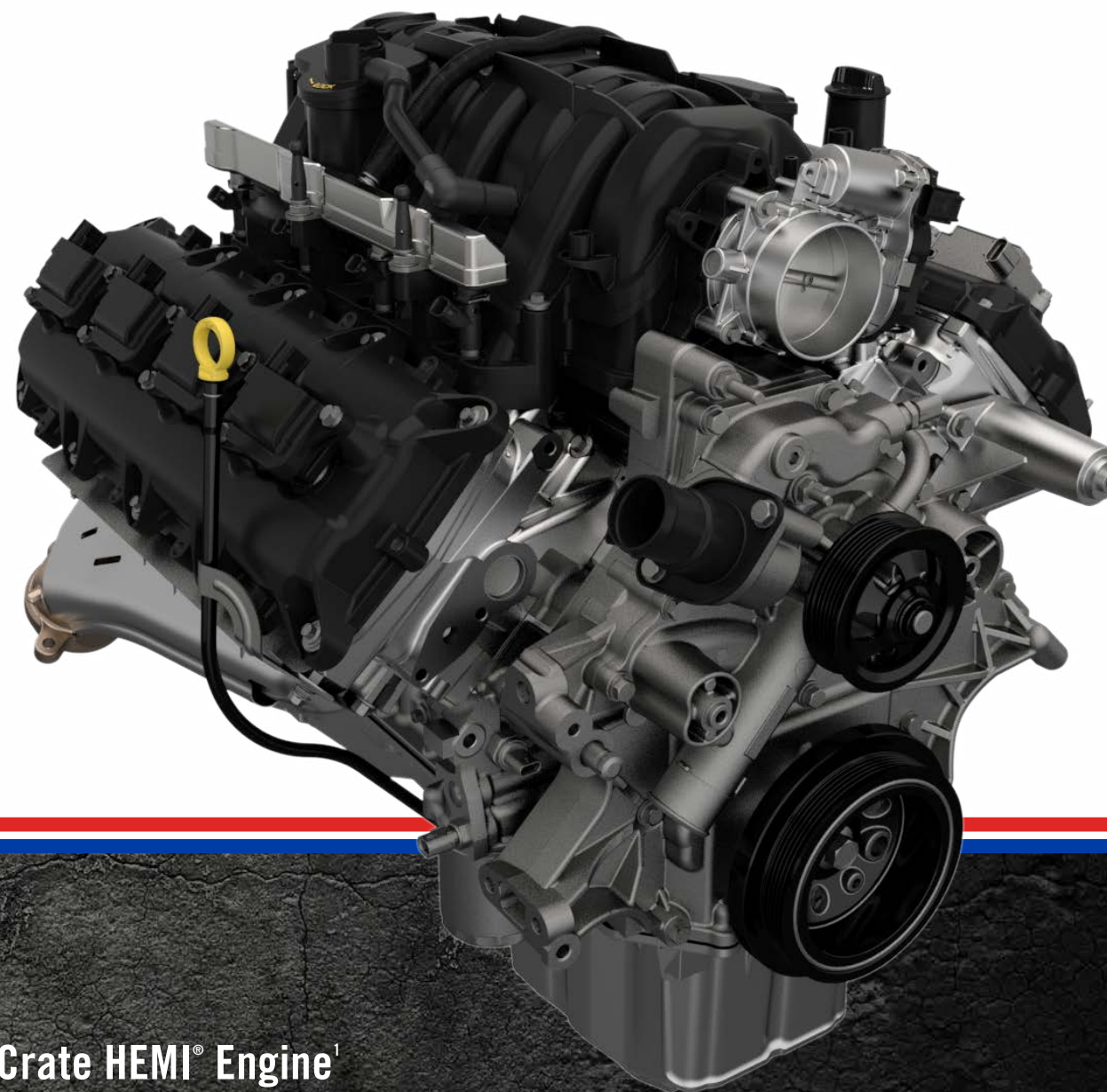

## 345 Crate HEMI® Engine<sup>1</sup>

Own the same legendary 345 HEMI® engine found in the 2015 and newer Dodge Challenger. Features: 383 horsepower and 417 lb.-ft. of torque. Includes complete engine assembly with water pump, flywheel and clutch, front sump oil pan, intake manifold with throttle body, fuel injectors and coil packs.

### FEATURES:

- Engine type GEN III HEMI V8
- Displacement 345 cu. in.
- Bore 99.5 mm
- Stroke 90.9 mm
- Block (P/N: 53021214DR) cast iron with 4-bolt powder metal caps
- Crank material nodular iron
- Connecting rods powdered metal
- Piston material hypereutectic aluminum
- Camshaft nodular iron

P/N: 68303088AB

Price: \$7,495.00

Warranty:  must purchase crate engine w/engine controller kit (P/N: 77072455AG, 77072453AG or 77072482AB)

<sup>1</sup>CRATE HEMI ENGINES ARE DESIGNED FOR INSTALLATION IN: 1. ANY MOTOR VEHICLE MANUFACTURED PRIOR TO MODEL YEAR 1976 OR 2. COMPETITION VEHICLES DRIVEN ON TRACKS OR OFF-ROAD. Vehicles manufactured 1976 and later equipped with this part should not be driven on public roads or highways. Direct Connection customers are responsible for ensuring that their use of their vehicle equipped with this part complies with applicable federal, state/provincial and local laws, regulations and ordinances. Vehicles manufactured 1976 and later equipped with this part and driven on public roads or highways may violate U.S., California, Canadian or local motor vehicle emissions laws and regulations.



# TRANSMISSIONS

CRATE ENGINES



## TREMEC Magnum Transmission Kit

Crate HEMI® Engine Manual Transmission Installation Kit for TREMEC T56 Magnum transmission. Known in its original equipment form as the "TR-6060," the Magnum is an aftermarket version of the same transmission found in many of today's most celebrated factory muscle cars, including the Dodge Challenger and Dodge Viper. Able to withstand a massive 700 lb.-ft. of torque while providing unbelievably crisp shifts. Comes with transmission assembly, clutch housing, fasteners and slave cylinder.

P/N: PW10003AB

Price: \$5,250.00

Warranty: 



## TREMEC Magnum Service Transmission

Replacement for TREMEC Magnum transmission with GEN III specific input shaft and mid-plate. For complete transmission kit, use P/N: PW10003AB

P/N: PW10004

Price: \$4,445.00

Warranty: 



CRATE ENGINES



# ENGINE CONTROLLERS

## Hellcrate 6.2L Supercharged HEMI® Non-E.O. Engine Kit<sup>3</sup>

This Hellcrate 6.2L Supercharged Crate HEMI® Non-E.O. Engine Kit includes:

- Accelerator pedal
- Engine wiring harness
- Chassis harness
- Power distribution center
- Ground jumper
- CAN Bus Interface device
- Fuel pump control module
- Wideband O2 sensors
- PCM
- Charge air temp. sensor
- Engine sold separately: Hellcrate 6.2L Supercharged Crate HEMI engine

P/N: 77072452AE

Price: \$2,265.00

Warranty<sup>4</sup>: 



## 392 Crate HEMI Non-E.O. Engine Kit<sup>3</sup>

This 392 Crate HEMI Non-E.O. Engine Kit includes:

- Accelerator pedal
- Engine wiring harness
- Chassis harness
- Power distribution center
- Ground jumper
- O2 sensors
- PCM
- Charge air temp. sensor
- Engine sold separately: 392 Crate HEMI engine

P/N: 77072454AH

Price: \$1,795.00

Warranty<sup>4</sup>: 



## 345 Crate HEMI Non-E.O. Engine Kit<sup>3</sup>

This 345 Crate HEMI Non-E.O. Engine Kit includes:

- Accelerator pedal
- Engine wiring harness
- Chassis harness
- Power distribution center
- Ground jumper
- O2 sensors
- PCM
- Charge air temp. sensor
- Engine sold separately: 345 Crate HEMI engine

P/N: 77072455AG

Price: \$1,795.00

Warranty<sup>4</sup>: 



<sup>3</sup>NON-E.O. CONTROLLER KITS ARE DESIGNED FOR INSTALLATION IN: 1. ANY MOTOR VEHICLE MANUFACTURED PRIOR TO MODEL YEAR 1976 OR 2. COMPETITION VEHICLES DRIVEN ON TRACKS OR OFF-ROAD. Vehicles manufactured 1976 and later equipped with this part should not be driven on public roads or highways. Direct Connection customers are responsible for ensuring that their use of their vehicle equipped with this part complies with applicable federal, state/provincial and local laws, regulations and ordinances. Vehicles manufactured 1976 and later equipped with this part and driven on public roads or highways may violate U.S., California, Canadian or local motor vehicle emissions laws and regulations.

<sup>4</sup>When engine kit is purchased without Crate engine, 24-month or unlimited-mile performance part warranty applies.





### Hellephant 426 Supercharged Crate HEMI® Non-E.O. Engine Kit<sup>3</sup>

This Hellephant 426 Supercharged Crate HEMI® Non-E.O. Engine Kit includes:

- Crate engine wiring/PDC kit
- PCM
- Wideband O2 sensors
- Ground jumper
- Accelerator pedal
- Intake duct
- CAI temperature sensor
- CAN Bus Interface device
- Fuel pump control module
- Make-up air hose
- Instruction sheet
- Engine sold separately: Hellephant 426 Supercharged Crate HEMI engine

P/N: 77072500AC

Price: \$2,265.00

Warranty<sup>4</sup>: 24-month UNLIMITED-mile warranty

### Hellcrate Redeye 6.2L Supercharged Crate HEMI Non-E.O. Engine Kit<sup>3</sup>

This Hellcrate Redeye 6.2L Supercharged Crate HEMI Non-E.O. Engine Kit includes:

- Crate engine wiring/PDC kit
- PCM
- Wideband O2 sensors
- Ground jumper
- Accelerator pedal
- Crankcase vent tube fitting (not a service part)
- Production make-up air hose
- Remove hose
- CAN Bus Interface device
- Fuel pump control module
- DUCT, air cleaner, fresh air
- Air filter
- Oil pressure sensor – 2016
- Knock sensor
- Instruction sheet
- Engine sold separately: Hellcrate Redeye 6.2L Supercharged Crate HEMI engine

P/N: 77072601AA

Price: \$2,375.00

Warranty<sup>4</sup>:

### 345 Stage 3 Crate HEMI Non-E.O. Engine Kit<sup>3</sup>

This 345 Stage 3 Crate HEMI Non-E.O. Engine Kit includes:

- Accelerator pedal
- Crate engine wiring/PDC kit
- Ground jumper
- O2 sensors
- PCM
- Charge air temperature sensor
- Instruction sheet
- Engine sold separately: 345 Crate HEMI engine

P/N: 77072482AB

Price: \$1,795.00

Warranty<sup>4</sup>:

<sup>3</sup>NON-E.O. CONTROLLER KITS ARE DESIGNED FOR INSTALLATION IN: 1. ANY MOTOR VEHICLE MANUFACTURED PRIOR TO MODEL YEAR 1976 OR 2. COMPETITION VEHICLES DRIVEN ON TRACKS OR OFF-ROAD. Vehicles manufactured 1976 and later equipped with this part should not be driven on public roads or highways. Direct Connection customers are responsible for ensuring that their use of their vehicle equipped with this part complies with applicable federal, state/provincial and local laws, regulations and ordinances. Vehicles manufactured 1976 and later equipped with this part and driven on public roads or highways may violate U.S., California, Canadian or local motor vehicle emissions laws and regulations.

<sup>4</sup>When engine kit is purchased without Crate engine, 24-month or unlimited-mile performance part warranty applies.



### 392 EC HEMI® Engine Kit<sup>3</sup>



This 392 EC HEMI® Engine Kit includes:

- Right and left catalytic converter
- Purge valve
- Charcoal canister
- Accelerator pedal
- Crate engine wiring/PDC kit
- Charcoal canister air filter
- Ground jumper
- O2 sensors
- PCM
- CAN Bus Interface
- Charge air temperature sensor
- Intake air filter
- Nut M10x1.50
- Stud M10x1.50x77.74
- Purge valve intake hose
- Oil pressure sensor
- Instruction sheet
- CARB E.O. D-265-62
- Engine sold separately: 392 Crate HEMI engine

P/N: 77072451AG

Price: \$3,295.00

Warranty<sup>4</sup>:

### 345 EC HEMI Engine Kit<sup>3</sup>



This 345 EC HEMI Engine Kit includes:

- Right and left catalytic converter
- Purge valve
- Charcoal canister
- Accelerator pedal
- Crate engine wiring/PDC kit
- Charcoal canister air filter
- Ground jumper
- O2 sensors
- PCM
- CAN Bus Interface
- Charge air temperature sensor
- Intake air filter
- Nut M10x1.50
- Stud M10x1.50x77.74
- Purge valve intake hose
- Oil pressure sensor
- Instruction sheet
- CARB E.O. D-265-62
- Engine sold separately: 345 Crate HEMI engine

P/N: 77072453AG

Price: \$3,195.00

Warranty<sup>4</sup>:

<sup>3</sup>NON-E.O. CONTROLLER KITS ARE DESIGNED FOR INSTALLATION IN: 1. ANY MOTOR VEHICLE MANUFACTURED PRIOR TO MODEL YEAR 1996, AND 2. ANY MOTOR VEHICLE MANUFACTURED WITH A WEIGHT OF 2500 KG (4500 LBS.), AND 3. IN ANY VEHICLE THAT LACKS FEATURES CUSTOMARILY ASSOCIATED WITH SAFE AND PRACTICAL HIGHWAY USE THAT IS OPERATED NOT ON A STREET OR HIGHWAY. IT MAY BE A VIOLATION OF FEDERAL LAW SUBJECT TO CIVIL PENALTY TO INSTALL A 392 EC HEMI ENGINE IN ANY MOTOR VEHICLE DESIGNED FOR TRANSPORT ON A STREET OR HIGHWAY THAT WAS MANUFACTURED IN MODEL YEAR 1996 AND LATER.

<sup>4</sup>When engine kit is purchased without Crate engine, 24-month or unlimited-mile performance part warranty applies.





# CRATE ENGINE COMPONENTS

## Exhaust



### Exhaust Manifold

Need an exhaust manifold solution for your 6.2L Supercharged/392/345 Crate HEMI® engine project car build? These SRT®-derived exhaust manifolds take up less room and offer a straight-down flange for compact installations. Not for use on E.O. applications.

P/N: 77072462AB  
 Price: \$419.00  
 Warranty:

## Engine Oiling & Parts



### 45-Degree Oil Filter Adaptor Kit for HEMI® Crate engine

45-Degree Oil Filter Kit includes adaptor, oil filter, seats and hardware.

P/N: 77072447  
 Price: \$98.00  
 Warranty:



### Rear Sump Oil Pan Kit for Car Crate HEMI® engine

Rear Sump Oil Pan Kit for Car Crate HEMI® engine. Kit includes oil pan, gaskets, pick-up tube, oil indicator, seals and hardware.

P/N: 77072450AB  
 Price: \$200.00  
 Warranty:



Front End Accessory Drive (FEAD) Kits

Power Steering Add On Kit for Car Crate HEMI® Engine

Power Steering Add On Kit for Car Crate HEMI® engine includes: power steering pump, belt and hardware.



P/N: 77072448  
 Price: \$232.00  
 Warranty:

Car Front End Accessory Drive (FEAD) Kit

Complete your Crate HEMI Engine Kit with this required Car FEAD Basic Kit that includes: 80 amp alternator, tensioner, belt, idler pulleys and hardware.

P/N: 77072445  
 Price: \$644.00  
 Warranty:



Front End Accessory Drive (FEAD) Basics Kit

Complete your Crate Kit with these other simple solutions for modernizing your classic Mopar® ride. 426 and 6.2L Supercharged Crate HEMI® Engines FEAD Basics Kit includes: alternator, power steering pump, pulleys and hardware.

P/N: 77072492  
 Price: \$696.00  
 Warranty:



6.2L / 426 SC Crate HEMI® Engines A/C Expansion Kit

426 and 6.2L Supercharged Crate HEMI Engine A/C Expansion Kit includes: new A/C compressor, wiring pigtail, belt and hardware. 77072493

P/N: 77072493  
 Price: \$387.00  
 Warranty:



5.7L / 6.4L Crate HEMI Engines A/C Expansion Kit

Hot? Direct Connection air conditioning compressors will help cool things off. This A/C Expansion Kit includes: compressor, wiring pigtail, belt and hardware.

P/N: 77072446AB  
 Price: \$360.00  
 Warranty:





# DRAG PAK

ENGINES	21
DRIVELINE	22
ENGINE COOLING	23
BODY & AERO	23
INTERIOR	24
2021 DODGE CHALLENGER MOPAR® DRAG PAK	26
ENGINE ELECTRICAL & CONTROLLERS	28
SUSPENSION UPGRADES	32
WHEELS & TIRES	33
GRAPHICS PACKAGES	36



## 354 Supercharged HEMI® Engine



Our latest evolution of the engine that won the 2018 NHRA Factory Stock Showdown and NMCA Factory Super Car championships, the 354 Supercharged HEMI® Drag Pak engine features numerous upgrades. Featuring an all-new 3.0-liter Whipple twin-screw supercharger, upgraded forged internals and a new front accessory drive, this engine combination is NHRA-rated at 630 hp and approved for NHRA FS/XX and NMCA FSS classes. NHRA mandates engine factored horsepower rating for vehicles that compete within specific NHRA sanctioned class(es) to achieve parity within each race class and does not represent actual engine output capability.

Comes fully assembled and ready to race with all of the below:

- Displacement 354 cu. in.
- Drag Pak-exclusive aluminum block and HEMI cylinder heads
- Forged internals – Winberg 8-counterweight crank, Carrillo H-beam rods, Diamond billet aluminum pistons
- Jesel valvetrain for improved rigidity
- 3.0 Whipple twin-screw supercharger
- 109 mm throttle body & 3.500” pulley
- American Racing headers – 304 stainless with merge collectors
- New front drive with billet timing gears & SFI-approved ATI damper
- Installed sensors: Cam & crank position, oil pressure & temperature, intake T-MAP (temperature & pressure)
- Moroso billet aluminum oil pan with fabricated aluminum sump
- Uses Shell Rotella T6 5W-40 (8 qt) & Mopar® oil filter (P/N: 05038041AA)
- Requires the following kits for plug-and-play installation:
  - Engine Systems Kit (P/N: P5160258AC)
  - ECU Kit (P/N: P5160240AA)
  - Drag Pak Electrical & Fuel Kit (P/N: P5160239AC)
  - Recommended fuel: VP C16

P/N: P5160354AC

Price: \$56,995.00

Warranty: No warranty, sold as-is



Driveline



Race Driveline Kit

Make the most of your engine with our Race Driveline Kit. Our Driveline Kit features race-proven components used widely by racers in factory stock racing, integrated and tested to ensure peak performance, pass after pass. Sold ready-to-race with the following:

- Shootout-style racing hydraulic 4-speed automatic featuring:
- SFI 29.1 certified flexplate
- Reid racing SFI 4.1 certified transmission case
- Reid racing SFI 30.1 certified lightweight bellhousing
- Aluminum drums & 300M/4340 input & main shaft
- 258 mm torque converter
- CNC-machined billet “Kwik-Shift” shifter with “neutral clean” valve body (P-R-1-2-3-N)
- Extended dipstick for easy fluid checks
- ATI Super Starter by Tilton (works with 12V/16V systems)
- Lightweight aluminum driveshaft with heavy-duty U-joints

P/N: P5160333AB

Price: \$19,795.00

Warranty: No warranty, sold as-is



Engine Cooling

Engine Systems Kit



The Engine Systems Kit features all the components needed to make your Drag Pak engine breathe right and stay cool. Features a brand-new 2-piece air intake for maximum performance. Contains components, hoses, fittings and hardware— all in one convenient package.

- Includes the following:
- Fabricated aluminum intercooler ice tank with clear lid
  - C&R racing aluminum radiator with 12” SPAL fan & shroud
  - 60” throttle cable
  - Twin electric water pumps (1 for each circuit)
  - Crankcase ventilation system with breather bottle & mounts
  - 2-piece air intake (for ease of service)
  - All associated hoses, fittings & hardware

P/N: P5160258AC

Price: \$5,495.00

Warranty: No warranty, sold as-is



Body & Aero

Exterior Kit



This kit complements the 7.50 Body Kit to complete the iconic and aggressive Dodge Challenger body. Combining Hellcat front and rear fascias with an SRT® Performance spoiler and some unique Drag Pak elements, we created a package that combines factory looks with racecar performance. Includes several components to ensure the closures (doors, hood and decklid) fit and function just as well as any road-going Challenger. The kit includes:

- Complete Hellcat front fascia (assembled) and support brackets
- Front headlamps, closeouts and fender wells
- Hellcat rear fascia with brackets
- Hood latch & cable, gas struts/ props
- Hood scoop bezel & heat extractors
- SRT Performance spoiler
- Rear center lamp assembly & decklid striker
- Door seals & weatherstripping
- Exterior door handles & lock cables
- Window motors with regulator & cables
- Carbon fiber closeouts for side mirror-delete
- Associated hardware for all of the above

P/N: P5160232AC

Price: \$5,895.00

Warranty: No warranty, sold as-is







## 7.50 Body Kit



Featuring an NHRA-certified rollcage, stripped-down Dodge Challenger chassis and extensive body modifications and lightweighting – the Drag Pak 7.50 Body Kit offers you the chance to get a quick and painless start to your Challenger racecar. We take a Challenger street car chassis straight from the factory and make several modifications to make life easier for the racer by improving the safety, stiffness and serviceability of the car at the track. Comes assembled with the following:

- Fully TIG-welded chromoly rollcage (SFI 25.5C: NHRA-legal to 7.50ET)
- All-new rollcage design for greater chassis stiffness
- Engine cross-member with lowered engine mounts
- Cut-outs in engine and transmission cross-members for easy service
- Mounting points for rear 4-link suspension, wishbone & dampers
- Includes doors, decklid & bumper beams
- Lightweight aluminum hood with center scoop & heat extractors
- NHRA-mandated driveshaft hoop & window net
- NHRA-certified roll cage
- The 7.50 Body Kit is available in additional colors, dependant on current Challenger exterior production colors
- Customer pick-up is required

P/N: P5161750AC

Price: \$22,995.00

Warranty: No warranty, sold as-is

## Interior

## Racetech Base Seat Kit



Our Base Seat Kit includes lightweight FIA-compliant Racetech composite seats and Racetech HANS-ready cam-lock harnesses (FIA and SFI-compliant). The kit contains:

- Racetech composite seats (driver & passenger) (FIA 8855-1999 compliant)
- Racetech HANS-ready 6-point driver harness (FIA 8853-1998 & SFI 16.1 compliant)
- Racetech HANS-ready 4-point passenger harness (FIA 8853-1998 & SFI 16.1 compliant)
- Racetech seat brackets
- All associated hardware

P/N: P5160251AA

Price: \$2,625.00

Warranty: No warranty, sold as-is



## Racetech Head Restraint Performance Seat Kit



Our upgraded Seat Kit includes lightweight FIA-compliant Racetech composite seats and Racetech HANS-ready cam-lock harnesses (FIA and SFI-compliant). The kit contains:

- Racetech full-containment composite driver seat with winged head restraints (FIA 8855-1999 compliant)
- Racetech composite passenger seat (FIA 8855-1999 compliant)
- Racetech HANS-ready 6-point driver harness (FIA 8853-1998 & SFI 16.1 compliant)
- Racetech HANS-ready 4-point passenger harness (FIA 8853-1998 & SFI 16.1 compliant)
- Racetech seat brackets (back and bottom braces)
- All associated hardware



P/N: P5160229AA

Price: \$5,495.00

Warranty: No warranty, sold as-is

## Interior Kit



The Drag Pak Interior Kit balances racecar function with factory comfort and finish. Along with a full dashboard and instrument panel with carbon-fiber bezels and custom Drag Pak engraved closeouts, the kit also includes mounts for the ECU, racing pedals, shifter and steering column. Rounding out the Factory Stock feel are a custom-cut lightweight carpet and SFI-compliant rollbar padding for the rollcage. The kit includes:

- Full dash panel, glove box, knee panels, A/C vents & trim
- Carbon fiber instrument panel bezel
- Mounts for control switches and Holley digital dash
- Full door trim panels, with control modules, window switches and latch strikers
- Trim panels for rockers, A-, B- & C- pillars and steering column
- Mounts for steering column, shifter, brake and accelerator pedals
- Front energy-absorber assembly
- SFI 45.1-compliant padding for cage
- Custom-fitted lightweight carpet
- All associated hardware and parts

P/N: P5160231AC

Price: \$6,495.00

Warranty: No warranty, sold as-is







## 2021 DODGE CHALLENGER MOPAR® DRAG PAK THE QUICKEST, FASTEST, MOST POWERFUL DRAG PAK EVER.

The 4th generation of drag strip domination is staged and ready for action.

The sold-out 2021 Dodge Challenger Mopar® Drag Pak was engineered for grassroots drag racers competing in sanctioned NHRA and NMCA sportsman classes. This factory, production-based turnkey package takes competition to the next level. Here's what makes it the quickest, fastest, most powerful Drag Pak ever...

# SPECIFICATIONS

### ENGINE

- 354 cu. in. HEMI® V8 engine
- Block: Mopar® cast aluminum block with billet steel main caps
- Bore & Stroke: 4.070" x 3.400"
- Crankshaft: Billet
- Rods: Forged H-beam
- Pistons: Forged 2618 alloy
- Camshaft: Mopar spec with 0.675" lift

### TRANSMISSION

- Automatic – TH400 with SFI case
- Race-ready 3-speed Turbo-400 transmission with lightweight aluminum driveshaft

### TORQUE CONVERTER

- 10" (258 mm) high-performance torque converter

### INTAKE MANIFOLD/INDUCTION

- Whipple 3.0L twin-screw supercharger

### THROTTLE BODY

- Billet aluminum, 109 mm

### HEADERS

- American Racing headers

### FUEL SYSTEM

- SFI-certified drag race fuel cell
- Brushless racing pump with dual inline filters

### GEARS & AXLES

- Strange Engineering custom Drag Pak axle
- 9" Aluminum center section
- 40-spline gun-drilled "Hy-Tuf" axles
- 4.11:1 final drive ratio

### DRIVESHAFT

- 4" diameter aluminum X 0.125" wall thickness
- 1350 Spicer U-joints

### ENGINE CONTROLS & IGNITION

- Holley Dominator EFI & 7" digital dash
- Racepak Smartwire PDM

### SAFETY

- Racetech lightweight FIA-certified seats
- SFI & FIA-certified safety harnesses
- Window net and driveshaft loop
- 10' cross-form parachute with integrated mount

### VALVETRAIN

- Tappets: Mechanical roller
- Rocker arms: 1.80:1 in, 1.85:1 ex ratio
- Valve springs: Dual drag race spring

### CYLINDER HEADS

- Aluminum: 2.20" in, 1.68" ex valves

### OIL AND COOLING

- Internal wet sump oil pump
- Fabricated aluminum pan
- Electric water pump

### DAMPER

- SFI-approved ATI Performance Products "Super Damper"

### CHASSIS

- 7.50 ET certified chromoly roll cage
- All-new design for improved chassis stiffness

### REAR SUSPENSION

- Four-link rear suspension with wishbone
- All-new geometry for improved performance
- Custom BILSTEIN Drag Pak double-adjustable coilovers
- Anti-roll bar (250% stiffer than previous generation)

### FRONT SUSPENSION

- Mopar K-member with integrated engine mounts
- Cut-out for easy oil pan removal
- Custom BILSTEIN Drag Pak double-adjustable coilovers

### STEERING

- Manual steering rack (15:1 ratio)

### BRAKES

- Strange Engineering front & rear rotors & calipers
- Line lock & brake pressure switch

### WHEELS

- Front: Bogart racing 17X4.5 aluminum
- Rear: Bogart racing 15X10 aluminum
- Available Weld Beadlock Lightweight Wheel upgrade

### TIRES

- Mickey Thompson™
- Front: ET Front® 27.5X4.0-17
- Rear: ET Drag® Pro Drag Radial 30.0X9.0R15



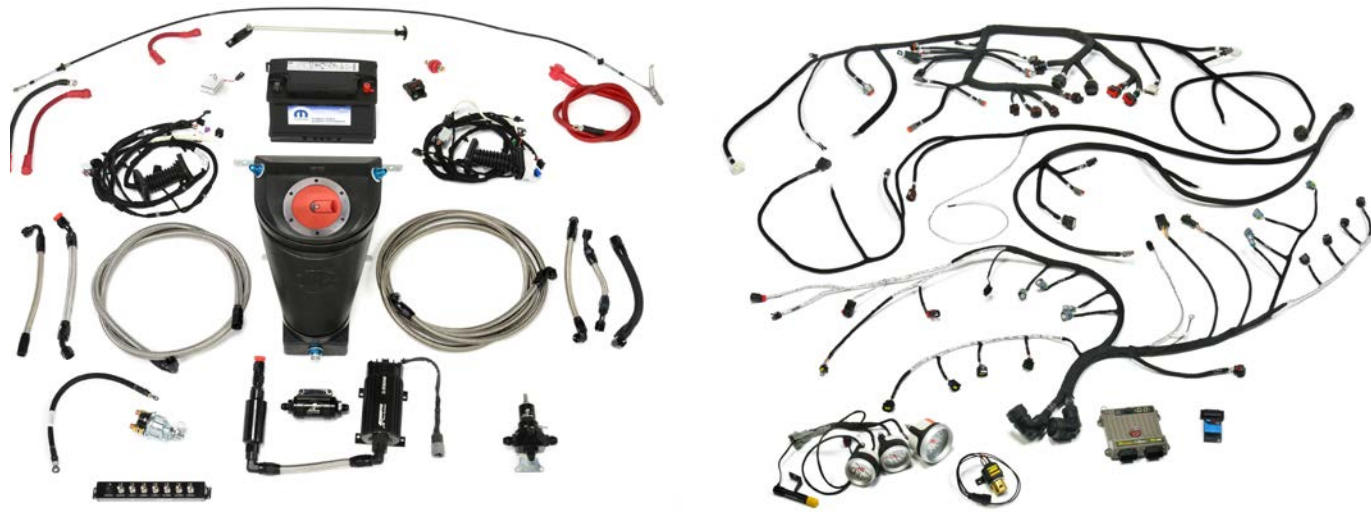

## Electrical and Fuel Kit



The Electrical and Fuel Kit contains everything needed to set up your Drag Pak's electrical system, as well as a complete plug-and-play fuel system from Aeromotive. It makes use of a user-programmable PDM (power distribution module) to eliminate the use of fuses, relays and solenoids. This gives racers the ability to make electrical changes without ever having to cut into the harness. The kit contains:

- Complete Aeromotive fuel system including:
  - Brushless inline fuel pump
  - Double inline fuel filters
  - Braided fuel and return lines
  - 30-120 psi adjustable regulator
  - All fittings, hoses (cut-to-length) and hardware
  - 3-gallon SFI-certified drag race fuel cell with safety foam
- Main body wiring harnesses with:
  - Engine & engine bay harness (with Holley coil drivers)
  - Trunk & battery harness
  - Quick-disconnect battery charging terminals (when used with Drag Pak 7.50 Body Kit, charging terminal located at stock fuel fill door)
  - Push/pull battery master disconnect switch (internal/external)
  - Line lock kit with microswitch
- Mopar® 12V battery
- Easy-to-read analog gauges by Autometer:
  - Tachometer
  - Oil Pressure
  - Brake Pressure
- Associated anti-vibration mounts and hardware

P/N: P5160239AC

Price: \$16,095.00

Warranty: No warranty, sold as-is



## ECU Kit



The Drag Pak ECU kit features the brain of the Drag Pak. We incorporate a top-of-the-line fully-programmable Holley Dominator EFI VMS and a Holley Digital Dash to tune, run and monitor the Drag Pak. The kit contains:

- Holley Dominator EFI vehicle management system featuring:
  - Fully-potted ECU with sealed automotive & marine grade connectors
  - Individual cylinder fuel and spark control
  - Advanced idle, closed loop and enrichment strategies allow for very stable engine operation
  - Can be used as a complete data acquisition system as well
- Holley EFI digital dash with:
  - 7" low-glare full-color touchscreen display – easily viewed even in sun
  - User-programmable shift lights, alarms and gauges/indicators
  - Can be programmed as a virtual switch panel
  - Weatherproof aluminum housing
  - View, download and save Holley EFI data logs to external USB memory stick
- 2 Holley wideband O2 sensors

P/N: P5160240AA

Price: \$4,695.00

Warranty: No warranty, sold as-is



# DODGE CHALLENGER STRIP DREAM BUILD

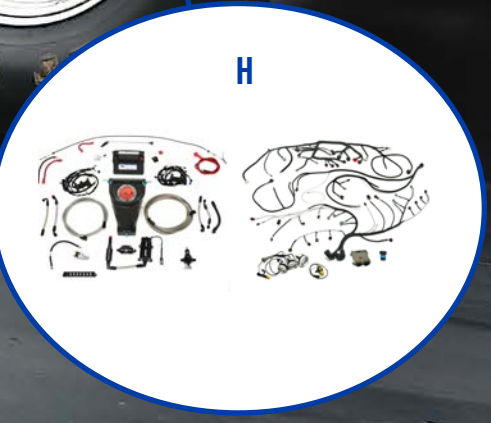
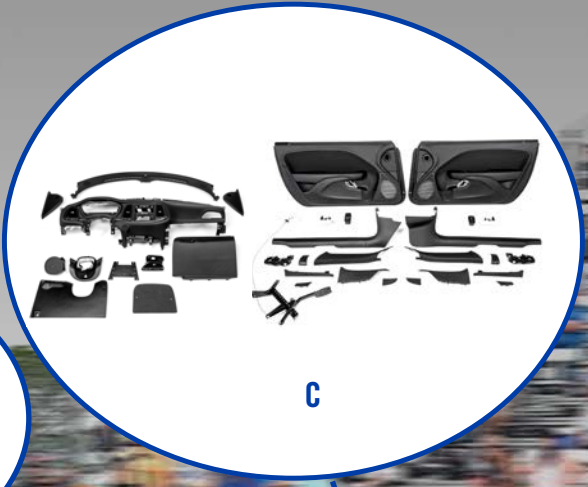

## PERFORMANCE

1/4 Mile: 9.0 sec (capable)

### COMPONENTS

Exterior Kit	\$5,895
Racetech Performance Seat Kit	\$5,495
Interior Kit	\$6,495
Weld Lightweight Wheel & Tire Kit	\$6,895
Race Suspension Kit	\$20,295
Race Driveline Kit	\$19,795
Hellcrate Redeye 6.2L Supercharged Crate HEMI® Engine	\$20,795
Hellcrate Redeye 6.2L Supercharged Crate Engine Kit	\$2,375
<b>Total Cost</b>	<b>\$88,040</b>

## PERFORMANCE

1/4 Mile: 7.5 sec (capable)

### COMPONENTS

A. Exterior Kit	\$5,895
B. Racetech Performance Seat Kit	\$5,495
C. Interior Kit	\$6,495
D. Weld Lightweight Wheel & Tire Kit	\$6,895
E. Race Suspension Kit	\$20,295
F. Race Driveline Kit	\$19,795
G. ECU Kit	\$4,695
H. Electrical & Fuel Kit	\$16,095
I. 354 SC Crate HEMI® Engine	\$56,995
J. Engine Systems Kit	\$5,495
<b>Total Cost</b>	<b>\$148,150</b>



## Suspension Upgrades



### Suspension Kit



The Drag Pak Suspension is engineered to launch hard, decimate the 60-foot and stay planted all the way to the finish line. Sporting an all-new 4-link rear end and double-adjustable BILSTEIN coilovers developed specially for the Drag Pak, it offers racers and crew chiefs plenty of adjustability to tune for diverse track conditions. A Strange Engineering 9" rear end and aluminum center section combines strength with low mass and rotational inertia to maximize acceleration. The package is rounded out by racing brakes from Strange Engineering that provide ample stopping power after the finish line, with minimal losses due to brake drag on the way there. The kit includes:

- Fixed lower link with adjustable upper link for tunability
- Heavy-duty wishbone with 1" slider
- Adjustable shock mounts
- Heavy-duty anti-roll bar
- Adjustable wheelie bars
- Strange Engineering 9" rear end with:
  - 4.11:1 final drive ratio
  - HD Pro aluminum center section
  - Heat-treated 8620 lightweight gears
  - 40-spline gun-drilled "Hy Tuf" ultra-strength axles
- Double-adjustable drag racing coilovers by BILSTEIN
- Lightweight steering column with quick-disconnect steering wheel
- Independent SLA with high upper A-Arm front suspension with manual steering rack
- Wilwood brake pedal & master cylinder with brake pressure switch
- Strange Engineering Pro Series II low-drag front & rear racing brakes
- Associated hardware and parts

P/N: P5160241AC

Price: \$20,295.00

Warranty: No warranty, sold as-is

## Wheels & Tires

### Weld Beadlock Lightweight Wheel & Tire Kit



Our upgraded Wheel and Tire Kit includes Weld Racing lightweight forged one-piece double beadlock wheels powdercoated black with a custom Drag Pak engraving, wrapped in non-DOT Mickey Thompson™ drag radials.

- Weld Racing V-Series front 17x4.5 frontrunner wheels
- Weld Racing Alpha-1 15x10 rear wheels (double-beadlock)
- Wheels powdercoated gloss black with exclusive Drag Pak engraving
- Mickey Thompson ET Front Tires 27.5X4.0-17
- Mickey Thompson ET Drag® Pro Drag Radial Tires 30.0X9.0R15
- Mounted & balanced with valve stems

P/N: P5160246AB

Price: \$6,895.00

Warranty: No warranty, sold as-is



### Bogart Lightweight Wheel & Tire Kit



The base wheel and tire kit includes Bogart racing aluminum wheels powdercoated matte black wrapped in non-DOT Mickey Thompson Drag radials.

The kit contains:

- Bogart 17x4.5 front wheels
- Bogart 15x10 rear wheels (non-beadlock)
- Wheels powdercoated matte black with Mopar engraving
- Mickey Thompson ET Front Tires 27.5X4.0-17
- Mickey Thompson ET Drag® Pro Drag Radial Tires 30.0X9.0R15
- Mounted & balanced with valve stems

P/N: P5160252AB

Price: \$4,865

Warranty: No warranty, sold as-is







## Rolling Chassis Drag Race Car

Build your own rolling chassis drag race car with purchase of Direct Connection Drag Pak kits. Start with the NHRA certified 7.50 Body Kit, Race Suspension Kit, Electrical and Fuel Kit, Exterior Kit, Interior Kit and Weld Beadlock Lightweight Wheel Kit. Assembly is required, with little to no additional fabrication. You add the Powertrain, Drivetrain and your preferred Engine Management System. The Drag Pak 7.50 Body Kit is built on the same production line as the 2021 Drag Pak, and includes the NHRA certification for 7.5-second ETs.

### Features include:

- Fully TIG-welded chromoly roll cage
- All-new 4-link rear end and double-adjustable BILSTEIN coilovers
- Strange Engineering 9" rear end
- Strange Engineering Pro Series II low-drag front & rear racing brakes
- Weld Beadlock Lightweight Wheels
- Mickey Thompson® Hoosier drag racing tires
- Racetech Racing seats
- Engine cooling kit

The Direct Connection Rolling Chassis is a purpose-built race car that does not carry a Vehicle Identification Number and it is not legal for road use. Drag Pak kits and rolling chassis are intended only for off-road drag racing and there is no warranty.

NOTE: The 7.50 Body Kit is available in additional colors, dependent on current Challenger exterior production colors.

To complete the drag race car, customer must add engine and engine mounts, engine controller, headers and exhaust system, coolant hoses, transmission (including torque converter), driveshaft and battery. SRT® Hellcat dual-snorkel hood (P/N: 77072554AC) can be purchased through Direct Connection for alternative appearance.

PART NUMBER	KITS	MSRP
P5161750AC	7.50 Body Kit	\$22,995
P5160241AC	Race Suspension Kit	\$20,295
P5160232AC	Exterior Kit	\$5,895
P5160246AB	Weld Beadlock Lightweight Wheel & Tire Kit	\$6,895
P5160231AC	Interior Kit	\$6,495
P5160251AA	Racetech Base Seat Kit	\$2,625
P5160258AC	Engine Systems Kit	\$5,495
<b>Total MSRP</b>		<b>\$70,695</b>



## Graphics Packages

### Drag Pak Full Color Livery

Graphics package includes blue Mopar logo and red “drag pak” graphics for installation on the quarter panels above the rear wheels. The red band wraps around the rear of the car, connecting the graphics. A wide blue stripe, with red tracers on each side, runs from the edge of the front fascia, over the roof and through to the rear edge of the decklid. A blue band runs along the lower quarter of each side of the Challenger, accented by a red tracer line.

P/N: P5160254AA

Price: \$5,995.00

Warranty: No warranty, sold as-is



### Direct Connection Full Color Livery

Graphics package includes blue Mopar logo and red “direct connection” graphics for installation on the quarter panels above the rear wheels. The red band wraps around the rear of the car, connecting the graphics. A wide blue stripe, with red tracers on each side, runs from the edge of the front fascia, over the roof and through to the rear edge of the decklid. A blue band runs along the lower quarter of each side of the Challenger, accented by a red tracer line.

P/N: P5160255AA

Price: \$5,995.00

Warranty: No warranty, sold as-is



### Drag Pak Monochromatic Livery

Graphics package includes monochromatic Mopar logo and “drag pak” graphics for installation on the quarter panels above the rear wheels. The monochromatic band wraps around the rear of the car, connecting the graphics. A wide monochromatic stripe, with tracers on each side, runs from the edge of the front fascia, over the roof and through to the rear edge of the decklid. A graphic band runs along the lower quarter of each side of the Challenger, accented by a tracer line.

P/N: P5160256AA

Price: \$5,995.00

Warranty: No warranty, sold as-is



### Direct Connection Monochromatic Livery

Graphics package includes monochromatic Mopar logo and “direct connection” graphics for installation on the quarter panels above the rear wheels. The monochromatic band wraps around the rear of the car, connecting the graphics. A wide monochromatic stripe, with tracers on each side, runs from the edge of the front fascia, over the roof and through to the rear edge of the decklid. A graphic band runs along the lower quarter of each side of the Challenger, accented by a tracer line.

P/N: P5160257AA

Price: \$5,995.00

Warranty: No warranty, sold as-is



### Dodge 1320 Club

Dodge is excited to recognize the achievements of enthusiasts competing at their local sanctioned quarter-mile drag strips with The Dodge 1320 Club on DodgeGarage.com. Whether it's a test 'n tune night or bracket race, Dodge owners have the opportunity to show off their official drag strip accomplishments with pride and challenge themselves and fellow racers to best their times to earn a top spot on either the Stock or Modified 1320 Club Leaderboard.

The Dodge 1320 Club is currently open exclusively to U.S. and Canadian owners of late model Dodge Challengers (2008-current) and Chargers (2006-current). Once you're a member, you'll have access to create a public profile showcasing your rides, comment on entries, submit official time slips from the drag strip for review and approval, view the most recent racing news articles, earn digital achievement badges, and get decals that show the world your 1/4-mile ET, 60 ft. time and 1/4-mile speed. Achievement badges and decals are available in gray for Stock or red for Modified. The 1320 Club decals are available to purchase with an exclusive 1320 Club hat.

Stock or Modified badges that can be earned:

- 1/4-Mile ET // Ranging from 7.8 to 13.9
- 60 Ft. Time // Ranging from 1.1 to 2.0
- 1/4-Mile Speed // Ranging from 105 to 170

Upload your time slips to join the leaderboard ranks for ultimate bragging rights!

How it works:

- Log in to your DodgeGarage.com account
- Visit the 1320 Club landing page to sign up
- New 1320 Club members will be required to:
  - Provide vehicle year, model and trim level details
  - Provide vehicle VIN (not for public display)
  - Select Stock or Modified and provide a list of modifications, if applicable
  - Create your “My Garage” public profile by uploading an image of your vehicle that will be connected to the time slips you submit
- Submit time slips to earn your spot on the leaderboard and achievement badges by:
  - Manually entering the track name, 1/4-Mile ET, 60 ft. Time and Top Speed as shown on your time slip
  - Upload 2 pictures of your time slip:
    - By itself to be displayed publically with your entry
    - Above your vehicle's VIN tag for vehicle eligibility verification
- Submissions are reviewed and verified by DodgeGarage admins
- When submissions are approved, you'll receive an email confirming your next level of achievement
- Achievement badges will be added to your DodgeGarage profile, can be shared on social media, and will be able to be purchased as decals to be displayed on your vehicle

The Dodge Brand does not endorse any form of street racing or reckless driving. All submissions must be from a sanctioned quarter-mile drag strip race facility.





1 3 5 R  
**HH DODGE GARAGE**  
 2 4 6

## 2022 DODGE NHRA SPORTSMAN RACER PROGRAM

The Dodge NHRA Sportsman Racer Contingency Program is an opportunity for some racers to make a few extra bucks for their efforts, going rounds during the big dance.

Having the following parts installed on your NHRA racing vehicle provides eligibility for rewards:

- DRAG PAK (Vehicle and Engine Assembly)
- ENGINE ASSEMBLY
- INTAKE MANIFOLD
- VALVE COVERS

### 2022 EVENTS AND REWARDS:

#### NHRA Stock & Super Stock (22 events):

- Winner: \$1,000
- Runner-up: \$500

#### NHRA Factory Stock Showdown (8 events):

- Winner: \$2,500
- Runner-up: \$1,000

#### Dodge Top Finisher Program (NHRA Stock & Super Stock):

- \$500 reward to Dodge/Mopar® driver who advances the furthest during eliminations

#### NHRA Sportsman Classes (22 events): Stock, Super Stock, Super Gas and Super Street

- Winner: \$300
- Runner-up: \$100

#### NHRA Class Elimination (Stock Eliminator & Super Stock):

- Up to \$1,000 to winners of heads-up eliminator races at select NHRA national events

#### Lucas Oil Drag Racing Regional events (45 events):

- Winner: \$100
- Runner-up: \$5





# MODERN PERFORMANCE

<b>BRAKES</b>	42
<b>DRIVETRAIN</b>	43
<b>ENGINE PARTS</b>	46
<b>EXHAUST</b>	54
<b>EXTERIOR</b>	60
<b>INTAKE &amp; AIR</b>	61
<b>INTERIOR ACCESSORIES</b>	74
<b>SUSPENSION</b>	77
<b>WHEELS</b>	83





## Brakes



### Challenger & Charger Performance Pads and Rotors

Direct Connection front and rear pads and rotors improve stopping performance. Features include slotted rotors to continuously prevent glazing and improve initial bite, OEM-sized rotors allow retention of existing factory calipers, black e-coated rotor hats. Meets FCA US LLC standards for durability and corrosion resistance and high MOT (max operating temperature) friction material to reduce fade.

P/N: P5160048

Price: \$568.00

Application:

2015+ Dodge Challenger RWD (BR5 and BR6 equipped),

2015+ Charger RWD 5.7L (BR5 equipped),

2015+ 300 (BR5 equipped)

Warranty: No warranty, sold as-is

### Dart Brake Kit

High-performance "track day" oversized 330 x 28 mm directional slotted front rotor. Front four-piston black with white Mopar logo calipers, front brake lines and high-performance "track day" high-friction pads.

Note: Requires 18" wheels.



P/N: P5156167AC

Price: \$1,895.00

Application: 2013-2017 Dodge Dart

Warranty: No warranty, sold as-is

## Drivetrain



### Redeye Torque Converter

High-stall torque converter for 2015+ Hellcat models with 8HP90 auto transmission. This converter not only allows a higher stall speed than the stock Hellcat torque converter, it also provides more torque multiplication for harder launches and lower ETs. 2.0 torque multiplication factor. Includes installation hardware.

P/N: 77072542AB

Price: \$1,235.00

Application: 2015+ Dodge Charger/Challenger 6.2L SRT® Hellcat

Warranty: 

### Shifter



Features an easy bolt-in shifter lever with an embossed billet aluminum knob. 1" shorter than production for a 4.5:1 lever ratio. Allows more precise shifts without increasing production-level NVH (noise/vibration/harshness). Will accommodate any 3/8-16 thread shifter knob.

P/N: P5155284AB

Price: \$153.00

Application: 2008-2014 Dodge Challenger w/manual transmission

Warranty: No warranty, sold as-is

### Shift Knob



Shifter knob for manual Challenger.

P/N: P5155705

Price: \$80.00

Application: 2008-2014 Dodge Challenger w/manual transmission

Warranty: No warranty, sold as-is



## Redeye Driveshaft

The Hellcat Redeye driveshaft is 20% stronger than a standard Hellcat driveshaft and proven to handle 770 ft.-lbs. of torque on the street and strip.

P/N: 77072536AB

Price: \$1,695.00

Application: 2015+ Dodge Challenger 6.2L SRT® Hellcat w/automatic transmission

Warranty: 



## Redeye Differential Assembly

Upgrade over standard 2.62:1 ratio Hellcat differential for improved acceleration and durability. Optimized for auto transmission applications. 3.09:1 ratio.

Note: Production part with 6.2L HO Redeye and Hellcat models.

Requires P/N: 77072535AA Redeye 41-Spline Half Shaft Kit.

P/N: 77072537AB

Price: \$1,995.00

Application:

Application: 2015+ Dodge Charger/Challenger 5.7L/6.4L/6.2L w/automatic transmission

Warranty: 



## Redeye Driveline Kit

Complete kit for 2015-2017 Hellcat models with 8HP90 auto trans, this bolt-in kit improves durability and lowers ETs at the track.

Includes Redeye Driveshaft Kit P/N: 77072536AB, Differential Kit P/N: 77072537AB and Half Shaft Kit P/N: 77072535AB.

P/N: 77072540AB

Price: \$4,955.00

Application: 2015+ Dodge Challenger 6.2L SRT Hellcat w/automatic transmission and 230 mm rear differential

Warranty: 



## Redeye 41-Spline Half Shafts

Featuring high-strength 41-spline barshafts and 8-ball CV joints, these Hellcat Redeye half shafts are proven to handle 770 ft.-lbs. of torque on the street and strip.

Note: This part is standard on the R/T Scat Pack Widebody, Scat Pack 1320, SRT Hellcat Redeye and SRT Demon models.

P/N: 77072535AB

Price: \$1,495.00

Application: 2015+ Dodge Charger/Challenger 5.7/6.4/6.2 w/230 mm rear differential

Warranty: 





## Engine Parts

MODERN PERFORMANCE



### Performance Tuning

- Install Direct Connection's Performance Calibrations to:
- Remove Top Speed Limiter
- Raise Rev Limiter

### OBD-II Code Reader

- Check Diagnostic Codes
- Includes text description

### Virtual Track Timers

- Onscreen track functions
- 0-60, 0-100 timing tests
- 1/8th mile and 1/4 mile track tests
- Exportable track time slip

### Monitor Gauges

- 15 different gauge screens
- Monitor parameters over OBDII
- Access parameter on/off switches
- Record performance data
- Customizable colors/themes

### Wi-Fi and Sensors

- Wi-fi Settings
- Screen settings
- Utility menus
- Setup Analog Sensors



## Redeye Pre-Stage Kit

For 2019+ 6.2L Dodge Challenger SRT® Hellcat Redeye and exclusive to Direct Connection, this wifi enabled device allows you to upgrade your engine calibration at the touch of a button. Simply plug in this device to your OBD-II port and select the calibration associated with your purchased stage kit.

Includes a handheld engine monitoring device and mounting hardware. Monitor and record performance data, 0-60, 1/4 mile and 1/8 mile, check diagnostic codes with different gauge screens and customizable themes and colors.

### Kit includes

- Direct Connection Tuner Kit
- Factory-tuned calibration for increased engine performance to 802 HP / 707 LBFT per SAE J1349 correction factor
- 50-state legal EO (EO # TBD)
- Performance air filter
- 180 degree F performance engine thermostat
- Factory-tuned calibration with 5-degree spark advance

### Direct Connection Tuner Kit features:

- Full-color, high-definition 5" touch screen
- Lightning-fast read/write times
- One-Touch, easy menu navigation
- Customizable gauge screen
- Layouts containing up to 5 different gauge screens per layout
- Custom color mixer to customize gauge arcs, backgrounds
- Full data logging capability
- Performance tests like 1/4 mile, 0-60 mph
- Wifi Updating
- AFM/MDS active fuel management options
- Read and clear diagnostic trouble codes
- Correct speedometer and adjust speed/rev limiters

P/N: 77072579AB

Price: \$1,195

Application: 2019+ Dodge Challenger SRT® Hellcat Redeye

Warranty:

## Redeye Stage I Kit



For 2019+ 6.2L Dodge Challenger SRT® Hellcat Redeye, increase your engine performance to 840 HP at the touch of a button when used in conjunction with the Redeye Pre-stage kit — no tools required.

\*Requires purchase of Redeye Pre-Stage kit (77072579AB)

Includes high performance calibration key code which unlocks factory-tuned Stage I calibration. 840 HP is achieved by enabling high octane functionality via Direct Connection Tuner Kit.

Turn-key HP upgrade for Challenger Hellcat Redeye

- Factory-tuned calibration for increased engine performance to 840 HP / 770 LBFT per SAE J1349 correction factor
- 50-state legal EO (EO # TBD)
- Enables high octane functionality
- High performance calibration key code which unlocks Stage I calibration

P/N: 77072581AB

Price: \$395

Application: 2019+ Dodge Challenger SRT® Hellcat Redeye

Warranty:



\*DC Tuner Kit Not Included



MODERN PERFORMANCE

## Redeye Stage II Kit



For 2019+ 6.2L Dodge Challenger SRT® Hellcat Redeye, increase your engine performance to 885HP at the touch of a button when used in conjunction with the Direct Connection Tuner Kit. Includes Hellephant pulley (80.5 mm/3.17" dia) for 2 lb increase of boost over stock and high performance factory-tuned calibration. 885HP is achieved by enabling high octane functionality via Direct Connection Tuner Kit. Note: While high octane mode is not engaged<sup>1</sup>, expected performance is 837HP.

\*Requires purchase of Redeye Pre-Stage kit (77072579AB)

Turn-key HP upgrade for Challenger Hellcat Redeye

- Factory-tuned calibration for increased engine performance to 885 HP / 787 LBFT per SAE J1349 correction factor
- 50-state legal EO (EO # TBD)
- 3.17in Hellephant Pulley
- High performance calibration key code which unlocks Stage II calibration
- Works in conjunction with high octane functionality

P/N: 77072583AB

Price: \$1,195

Application: 2019+ Dodge Challenger SRT® Hellcat Redeye

Warranty:



\*DC Tuner Kit Not Included



<sup>1</sup>Use of gasoline with a lower than recommended octane number can cause engine failure and may void or not be covered by the Performance Limited Warranty. When the High Octane mode is not engaged, the PCM requires a high-quality unleaded "Premium" gasoline having a posted octane number of 91 or higher as specified by the (R+M)/2 method. When the High Octane mode button is engaged, the calibration requires high-quality unleaded gasoline with a posted octane number of 100 as specified by the (R+M)/2 method. If the fuel mixture in the tank does not meet the required 100 octane number during High Octane mode, the calibration will revert back to the original 91 octane calibration to avoid engine damage.





### Hellcat Pre-Stage Kit



For 2019+ 6.2L Dodge Challenger SRT® Hellcat and exclusive to Direct Connection, this wifi enabled device allows you to upgrade your engine calibration at the touch of a button. Simply plug in this device to your OBD-II port and select the calibration associated with your purchased stage kit.

Includes a handheld engine monitoring device and mounting hardware. Monitor and record performance data, 0-60, 1/4 mile and 1/8 mile, check diagnostic codes with different gauge screens and customizable themes and colors.

**Kit includes**

- Direct Connection Tuner Kit
- Factory-tuned calibration for increased engine performance to 722 HP / 656 LBFT per SAE J1349 correction factor
- 50-state legal EO (EO # TBD)
- Performance air filter
- 180 degree F performance engine thermostat
- Factory-tuned calibration with 5-degree spark advance

**Direct Connection Tuner Kit features:**

- Full-color, high-definition 5" touch screen
- Lightning-fast read/write times
- One-Touch, easy menu navigation
- Customizable gauge screen
- Layouts containing up to 5 different gauge screens per layout
- Custom color mixer to customize gauge arcs, backgrounds
- Full data logging capability
- Performance tests like 1/4 mile, 0-60 mph
- Wifi Updating
- AFM/MDS active fuel management options
- Read and clear diagnostic trouble codes
- Correct speedometer and adjust speed/rev limiters

P/N: 77072609AA

Price: \$1,195

Application: 2015+ Dodge Challenger Hellcat

Warranty:



\*DC Tuner Kit Not Included



### Hellcat Stage I Kit



For 2019+ 6.2L Dodge Challenger SRT® Hellcat, increase your engine performance to 757HP at the touch of a button when used in conjunction with the Direct Connection Tuner Kit. Includes Hellephant pulley (80.5 mm/3.17" dia) for 2 lb increase of boost over stock and high performance factory-tuned calibration.

\*Requires purchase of Hellcat Pre-Stage kit (77072609AA)

**Turn-key HP upgrade for Challenger Hellcat**

- Factory-tuned calibration for increased engine performance to 757 HP / 696 LBFT per SAE J1349 correction factor
- 50-state legal EO (EO # TBD)
- 3.17in Hellephant Pulley
- High performance calibration key code which unlocks Stage I calibration

P/N: 77073001AA

Price: \$895

Application: 2015+ Dodge Challenger Hellcat

Warranty:



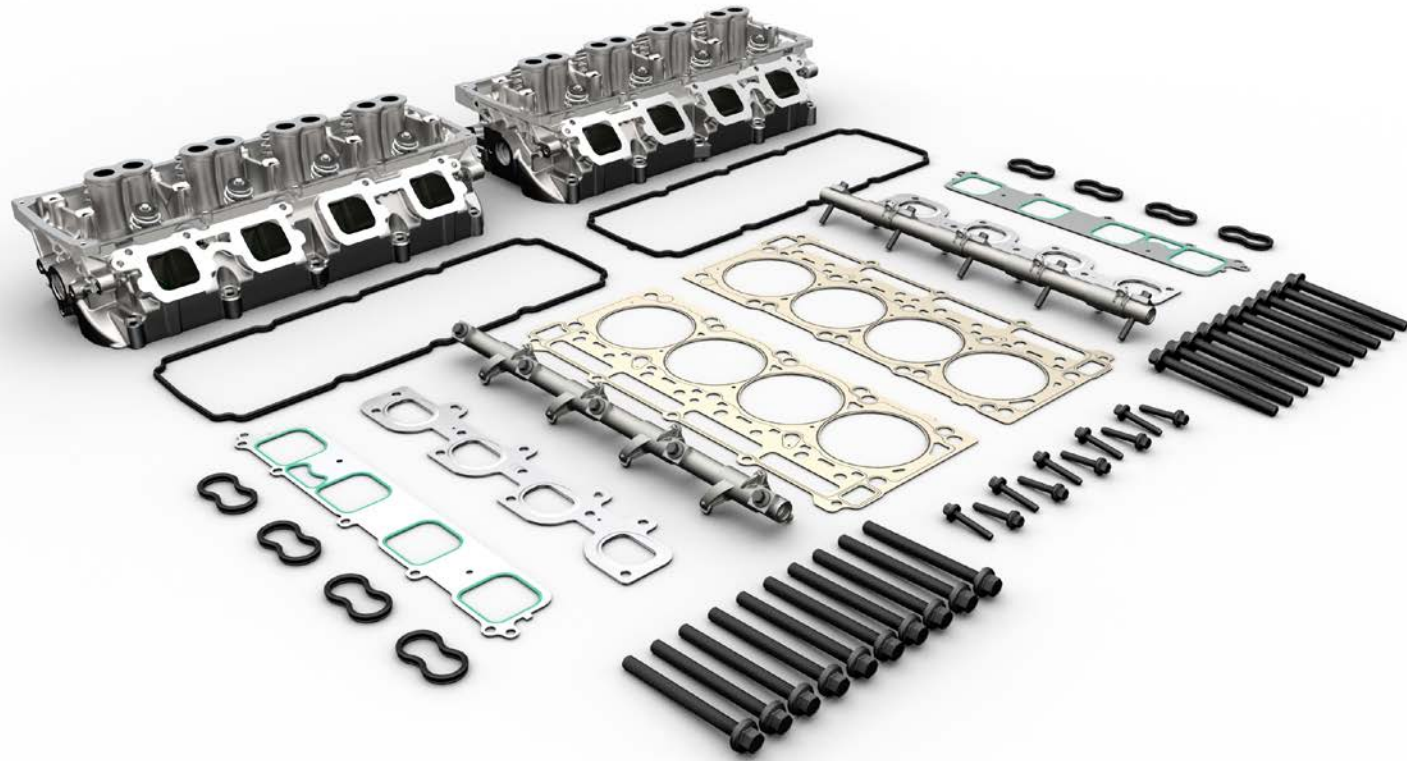

## Redeye Cylinder Heads, Complete



Sold as a complete set, these Hellcat Redeye cylinder heads allow you to increase your 2015+ Hellcat engine redline to 6,500 RPM. Features 2.14-in. hollow stainless steel intake valves and 1.65-in. sodium-filled exhaust valves. Includes gaskets and mounting hardware.

This add-on or modified part is considered 50-state "Street Legal" because it has an Executive Order from the State of California. (E.O. TBD)

P/N: 77072534AB

Price: \$2,595.00

Application: 2015+ Dodge Charger/Challenger 6.2L SRT® Hellcat

Warranty:



## Redeye Piston and Rod Kit



Derived from the 840 HP record-setting Dodge SRT® Demon, add this kit to your 6.2L SRT® Hellcat for increased bottom-end strength and durability.

This add-on or modified part is considered 50-state "Street Legal" because it has an Executive Order from the State of California. (E.O.TBD)

P/N: 77072550AB

Price: \$3,195.00

Application: 2015+ Dodge Charger/Challenger 6.2L SRT Hellcat

Warranty:



## Performance Camshaft

The Direct Connection Camshaft with phase limiter is based on the popular COMP series of camshafts with slightly modified cam timing to increase low-end torque without sacrificing high-end power (thanks to an optimized VCT calibration). The cam measures 222/230 at 0.050" (270/282 at 0.006") and has just under 0.600" lift with a 115-degree lobe separation angle.

**NOTE:** Not 50-State legal. For off-road use only.

**P/N:** P5160018

**Price:** \$1,060.00

**Application:** 2009+ 5.7L HEMI®

**Warranty:** No warranty, sold as-is





## Exhaust

### Cat-Back Exhaust System

Cat-back exhaust – 5.7L. Includes quad exhaust tips with Mopar® “M” logo.

P/N: P5155283

Price: \$1,275.00

Application: 2013-2014 Dodge Challenger 5.7L

Warranty: No warranty, sold as-is



### Cat-Back Exhaust System

Performance dual cat-back exhaust system for 5.7L engines. Does not include exhaust tips. Utilize production exhaust tips.

P/N: P5160040AB

Price: \$1,395.00

Application: 2015-2016 Dodge Challenger 5.7L

Warranty: No warranty, sold as-is



### Cat-Back Exhaust System

High-performance cat-back exhaust system fits Dodge Durango vehicles equipped with a 5.7L HEMI® engine. The kit includes the exhaust and tips.

P/N: 77072479

Price: \$1,595.00

Application: 2012-2021 Dodge Durango 5.7L

Warranty: 









# RADFORD

R A C I N G S C H O O L

Radford Racing School, the Official High Performance Driving School of Dodge//SRT®, is home for the next generation of world-class high-performance driving and racing instruction.

Founded in 1968, the school is the largest purpose-built driver training facility of its kind in North America. At the heart of the 450-acre racing facility is the 1.6-mile, 15-turn track, along with 3 additional road courses and an NHRA drag strip.

Learning how to properly handle the power and capabilities of a Dodge SRT vehicle with confidence in a safe environment is important. That's why Dodge SRT vehicle purchases include the 1-day SRT Experience Class at Radford Racing School. Submit your qualifying VIN within the first 12 months of taking delivery to begin the registration process. Only select, qualifying models are included for submission. You must take delivery of your vehicle before you submit your VIN. Visit [DodgeGarage.com/track-experience](http://DodgeGarage.com/track-experience) for more information!





## Exterior

### 2019 Hellcat Hood

When combined with the air catcher headlamp and an inlet near the wheel liner, these three sources give the SRT® Hellcat's dual-snorkel hood an 18% greater airflow rate than the 2018 SRT Hellcat air assembly at over 1,100 CFM. The revised air inlet path on the dual-snorkel hood results in an intake air temperature reduction of 4 degrees Fahrenheit.

P/N: 77072554AB

Price: \$1,495.00

Application: 2015+ Dodge Challenger

Warranty: 

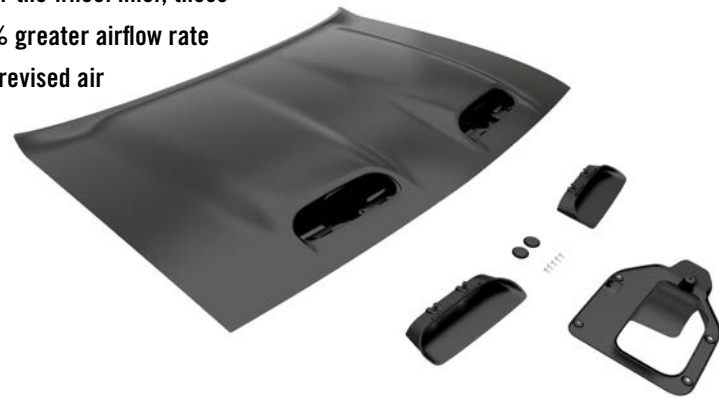

### Challenger SRT® Hellcat Front Fascia Kit

Increases airflow to engine compartment for improved engine cooling plus increased downforce compared to a standard Challenger fascia.

Note: Eliminates factory-equipped fog lamps, includes fog lamp wiring termination plugs.

P/N: 77072556AB

Price: \$1,995.00

Application: 2015+ Dodge Challenger

Warranty: 



### Challenger Widebody Fender Flare Kit

Designed to fit up to 315 mm width tires while offering aggressive styling, the widebody fender flare kit helps you get more rubber on the road for improved acceleration, cornering and braking.

Note: Cutting/drilling of body panels required for installation. Mounting hardware, instructions and templates included. Front fascia deletes factory fog lamps if equipped, wire termination plugs included.

P/N: 77072552AB

Price: \$2,495.00

Application: 2015+ Dodge Challenger

Warranty: 



## Intake & Air

### Challenger Illuminated Air Catcher Headlamp Kit

Add the distinctive look of the 2017+ Challenger with these illuminated Air-Catcher headlamps for your 2017+ Dodge Challenger (fits R/T 5.7L, 6.4L, 6.2L). Headlamp cylindrical lenses features the Dodge Rhombi design. Recommend use with the Redeye Air Box Kit P/N: 77072546AC or Hellcat Air Box Kit P/N: 77072559AB

P/N: 77072548AC

Price: \$1,675.00

Application: 2015-2017 Dodge Challenger 5.7L/6.4L/6.2L

Warranty: 

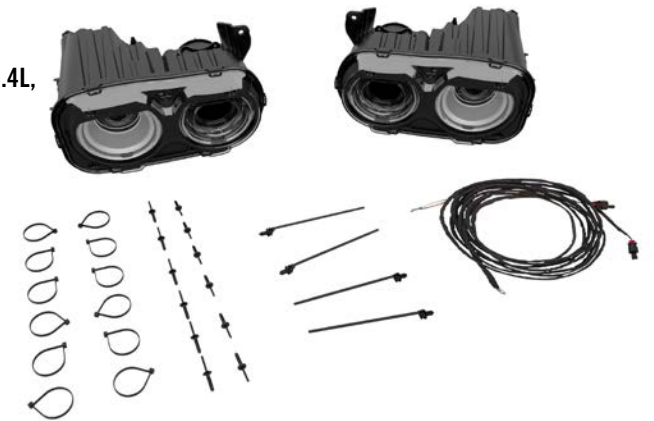

### Challenger SRT® Hellcat Air Box & Air Catcher Intake Kit



This high-flow air box kit includes the air catcher inlet duct made famous in the 2015 Challenger SRT® Hellcat for improved airflow and reduced air charge temps to the engine. Fits 2015+ 5.7L, 6.4L and 6.2L equipped Challenger models. Note: Standard on T/A and 1320 models, not compatible with Shaker Hood/Intake models. This add-on or modified part is considered 50-state "Street Legal" because it has an Executive Order from the State of California. (E.O. TBD)

P/N: 77072559AB

Price: \$195.00

Application: 2015+ Dodge Challenger 5.7/6.4L

Warranty: 



### Redeye High-Flow Air Box



This complete air box kit uses a large open element air filter to reduce inlet restriction and let your engine breathe more freely. Fits 2018+ Challenger SRT® Hellcat models with electric power steering.

This add-on or modified part is considered 50-state "Street Legal" because it has an Executive Order from the State of California. (E.O. TBD)

P/N: 77072546AB

Price: \$565.00

Application: 2018+ Dodge Challenger 6.2L SRT Hellcat w/electric power steering

Warranty: 





## Cold Air Intake Kit



Cold air intake kit for 3.6L. This add-on or modified part is considered 50-state "Street Legal" because it has an Executive Order from the State of California. (E.O. D-265-51)

P/N: 77070045AB  
 Price: \$514.00  
 Application: 2011-2018 Dodge Challenger/Charger 3.6L & Chrysler 300 3.6L  
 Warranty:



## Cold Air Intake Kit



Cold air intake kit for 5.7L. This add-on or modified part is considered 50-state "Street Legal" because it has an Executive Order from the State of California. (E.O. D-265-51)

P/N: 77070044AD  
 Price: \$502.00  
 Application: 2011-2018 Dodge Challenger/Charger 5.7L & Chrysler 300 5.7L  
 Warranty:



## Air Filter

Replacement air filter for Challenger T/A models.

P/N: 68322213AA  
 Price: \$121.00  
 Application: 2017-2019 Dodge Challenger T/A models  
 Warranty:



## Headlamp Duct Tube

Headlamp duct tube conducts cold air from the headlamp port (same as Hellcat) to the Mopar cold air intake system (P/N: 77070043AC for 6.4L engines or 77070044AD for 5.7L engines). Dodge Challenger only.

P/N: 77072385  
 Price: \$60.00  
 Application: 2015-2018 Dodge Challenger  
 Warranty:



## Cold Air Inlet Tube Kit



Cold air inlet tube kit for vehicles equipped with Shaker Hood Package. Includes powdercoated aluminum tube with Mopar logo, connectors and clamps. 5.7L engines. This add-on or modified part is considered 50-state "Street Legal" because it has an Executive Order from the State of California. (E.O. D-265-47)

P/N: 77072381  
 Price: \$242.00  
 Application: 2011-2018 Dodge Challenger/Charger 5.7L & Chrysler 300 5.7L  
 Warranty:



## T/A Hood Cold Air Intake Kit



Air induction kit includes underhood bezel, cold air induction system and headlamp air intake duct, same as Hellcat. This add-on or modified part is considered 50-state "Street Legal" because it has an Executive Order from the State of California. (E.O. D-265-50)

P/N: 77072436  
 Price: \$748.00  
 Application: 2011-2017 Dodge Challenger 5.7L/6.4L  
 Warranty:



## Cold Air Intake Kit



Cold air intake for vehicles with T/A Hood Venting System P/N: 82214854 - 5.7L engine and T/A Hood P/N: 822111665AD or 82214313. This add-on or modified part is considered 50-state "Street Legal" because it has an Executive Order from the State of California. (E.O. D-265-56)

P/N: 77072361AB  
 Price: \$511.00  
 Application: 2011-2018 Dodge Challenger 5.7L  
 Warranty:



## Cold Air Intake Kit



Cold air intake kit is designed to fit vehicles equipped with 6.4L engines. Kit includes air box, air filter, adapter hose and all associated hardware. This add-on or modified part is considered 50-state "Street Legal" because it has an Executive Order from the State of California. (E.O. D-265-51)

P/N: 77070043AC  
 Price: \$462.00  
 Application: 2011-2018 Dodge Challenger 6.4L, 2012-2018 Dodge Charger 6.4L, 2012-2018 Chrysler 300 6.4L  
 Warranty:





## Cold Air Intake Kit

This easy-to-install, bolt-on system is designed to allow cooler outside air through a directional cone filter and funnel directly into the intake manifold. This kit provides noticeable horsepower and torque gains under varying atmospheric conditions, fits your exact vehicle model and has been rigorously tested to ensure its unparalleled quality. Kit includes all mounting hardware and a dry media, washable/reusable filter (do not oil).

P/N: 68239826AA  
 Price: \$525.00  
 Application: 2008+ Dodge Challenger 5.7L / 6.4L w/Shaker Hood  
 Warranty: 



## Cold Air Intake Kit



This easy-to-install, bolt-on system is designed to allow cooler outside air through a directional cone filter and funnel directly into the intake manifold. This kit provides noticeable horsepower and torque gains under varying atmospheric conditions, fits your exact vehicle model and has been rigorously tested to ensure its unparalleled quality. Kit includes all mounting hardware and a dry media, washable/reusable filter (do not oil). (E.O. D-265-28)

P/N: 77070029  
 Price: \$375.00  
 Application: 2008-2010 Dodge Challenger 5.7L/6.1L,  
 2004-2010 Dodge Charger 5.7L/6.1L,  
 2008-2010 Chrysler 300 5.7L/6.1L  
 Warranty: 



## Cold Air Intake Kit



This easy-to-install, bolt-on system is designed to allow cooler outside air through a directional cone filter and funnel directly into the intake manifold. This kit provides noticeable horsepower and torque gains under varying atmospheric conditions, fits your exact vehicle model and has been rigorously tested to ensure its unparalleled quality. Kit includes all mounting hardware and a dry media, washable/reusable filter (do not oil). This add-on or modified part is considered 50-state "Street Legal" because it has an Executive Order from the State of California. (E.O. D-265-30)

P/N: 77060019AB  
 Price: \$420.00  
 Application: 2009-2010 Dodge Challenger 3.5L,  
 2006-2010 Dodge Charger 3.5L,  
 2005-2008 Dodge Magnum 3.5L,  
 2005-2010 Chrysler 300 3.5L  
 Warranty: 



## Cold Air Intake Kit



This easy-to-install, bolt-on system is designed to allow cooler outside air through a directional cone filter and funnel directly into the intake manifold. This kit provides noticeable horsepower and torque gains under varying atmospheric conditions, fits your exact vehicle model and has been rigorously tested to ensure its unparalleled quality. Kit includes all mounting hardware and a dry media, washable/reusable filter (do not oil). This add-on or modified part is considered 50-state "Street Legal" because it has an Executive Order from the State of California. (E.O. D-265-30)

P/N: 77060019AB  
 Price: \$420.00  
 Application: 2009-2010 Dodge Challenger 3.5L,  
 2006-2010 Dodge Charger 3.5L,  
 2005-2008 Dodge Magnum 3.5L,  
 2005-2010 Chrysler 300 3.5L  
 Warranty: 



## Cold Air Intake Kit



This easy-to-install, bolt-on system is designed to allow cooler outside air through a directional cone filter and funnel directly into the intake manifold. This kit provides noticeable horsepower and torque gains under varying atmospheric conditions, fits your exact vehicle model and has been rigorously tested to ensure its unparalleled quality. Kit includes all mounting hardware and a dry media, washable/reusable filter (do not oil). (E.O. D-265-30)

P/N: 77060006AB  
 Price: \$425.00  
 Application: 2008-2010 Dodge Challenger 6.1L,  
 2006-2010 Dodge Charger 6.1L,  
 2005-2008 Dodge Magnum 6.1L,  
 2005-2010 Chrysler 300C 6.1L  
 Warranty: 



## Cold Air Intake Kit



This easy-to-install, bolt-on system is designed to allow cooler outside air through a directional cone filter and funnel directly into the intake manifold. This kit provides noticeable horsepower and torque gains under varying atmospheric conditions, fits your exact vehicle model and has been rigorously tested to ensure its unparalleled quality. Kit includes all mounting hardware and a dry media, washable/reusable filter (do not oil). (E.O. D-265-26)

P/N: 77060080  
 Price: \$275.00  
 Application: 2007-2009 Dodge Nitro 3.7L,  
 2009-2010 Dodge Challenger 3.5L  
 Warranty: 





## Cold Air Intake Kit



Cold air intake for the 5.7L engine – not compatible with sport hood (MC9). This add-on or modified part is considered 50-state “Street Legal” because it has an Executive Order from the State of California. (E.O. D-265-51)

P/N: 77070041  
 Price: \$447.00  
 Application: 2011-2018 Durango 5.7L  
 Warranty:



## Cold Air Intake Kit



Cold air intake for the 3.6L engine. This add-on or modified part is considered 50-state “Street Legal” because it has an Executive Order from the State of California. (E.O. D-265-51)

P/N: 77070042  
 Price: \$425.00  
 Application: 2011-2018 Durango 3.6L  
 Warranty:



## Cold Air Intake Kit



This cold air intake upgrade gives your Dart more breathing power and increases thermal efficiency, especially in turbocharged applications. Cold air mitigates performance degradation when used in high-altitude conditions. Kit includes hoses, hardware and washable, reusable filter element. This add-on or modified part is considered 50-state “Street Legal” because it has an Executive Order from the State of California. (E.O. D-265-48)

P/N: 77070082  
 Price: \$403.00  
 Application: 2013-2016 Dodge Dart 1.4L Turbo  
 Warranty:



## Cold Air Intake Kit



This cold air intake upgrade gives your Dart more breathing power and increases thermal efficiency, especially in turbocharged applications. Cold air mitigates performance degradation when used in high-altitude conditions. Kit includes hoses, hardware and washable, reusable filter element. Cold Air Intake Kit for 2.4L. Does not work on PZEV (Partial Zero Emissions Vehicle). This add-on or modified part is considered 50-state “Street Legal” because it has an Executive Order from the State of California. (E.O. D-265-48)

P/N: 77070083  
 Price: \$343.00  
 Application: 2013-2016 Dodge Dart 2.4L  
 Warranty:



## Cold Air Intake Kit



This easy-to-install, bolt-on system is designed to allow cooler outside air through a directional cone filter and funnel directly into the intake manifold. This kit provides noticeable horsepower and torque gains under varying atmospheric conditions, fits your exact vehicle model and has been rigorously tested to ensure its unparalleled quality. Kit includes all mounting hardware and a dry media, washable/reusable filter (do not oil). (E.O. D-265-26)

P/N: 77060004AB  
 Price: \$374.00  
 Application: 2003-2005 Dodge Neon SRT4  
 Warranty:



## Blow-Off Valve Conversion Kit

Blow-off valve conversion kit, Anodized Blue, 2003-2005 Neon SRT4, 2003-2009 PT Turbo, 2008-2009 Caliber SRT4.

P/N: P4510548  
 Price: \$88.00  
 Application: 2003-2005 Dodge Neon SRT4, 2003-2009 Chrysler PT Turbo, 2008-2009 Dodge Caliber SRT4, 2009-2010 Dodge Challenger 3.5L  
 Warranty: No warranty, sold as-is

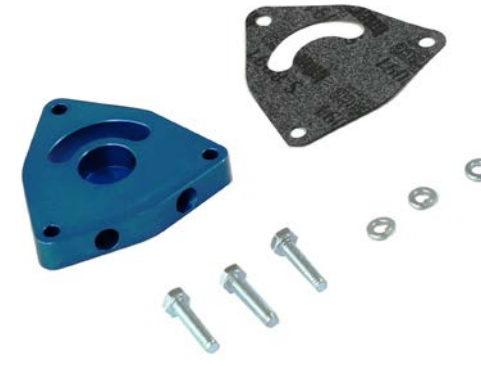

## Cold Air Intake Kit



This easy-to-install, bolt-on system is designed to allow cooler outside air through a directional cone filter and funnel directly into the intake manifold. This kit provides noticeable horsepower and torque gains under varying atmospheric conditions, fits your exact vehicle model and has been rigorously tested to ensure its unparalleled quality. Kit includes all mounting hardware and a dry media, washable/reusable filter (do not oil). (E.O. D-265-43)

P/N: 77070048  
 Price: \$342.00  
 Application: 2011-2014 Dodge Avenger, Chrysler 200 3.6L  
 Warranty:





### Air Filter

P/N: 68198995AA  
 Price: \$75.00  
 Application: Replacement filter for 5.7L & 6.4L cold air intake kits  
 P/N: 77070043, 77070044, 77070043AB & 44AB  
 Warranty: 



### Air Filter

P/N: 68198997AA  
 Price: \$62.20  
 Application: Replacement air filter for 2012 1.4L FIAT® 500 P/N: 77070046  
 Warranty: 

### Air Filter

This filter offers high flow and low restriction, better throttle response and increased filtration and horsepower. Filters are washable and reusable. Do not oil dry media filters.

P/N: 77070011  
 Price: \$65.00  
 Application: USED TO SERVICE KIT P/N: 77060004, 77060016 & 77060019  
 Warranty: 



### Air Filter

P/N: 68256672AA  
 Price: \$75.10  
 Application: Replacement air filter for 5.7L & 6.4L cold air intake kits P/N: 77070043AC, 77070044AC, 77070044AD & 68239826AA (shaker with plastic filter adapter).  
 Warranty: 



### Air Filter

This filter offers high flow and low restriction, better throttle response, and increased filtration and horsepower. Filters are made of a dry media material and are washable and reusable. Do not oil dry media filters.

P/N: 77070012  
 Price: \$75.00  
 Application: USED TO SERVICE KIT P/N: 77060005, 77060009, 77070004 & 77070006  
 Warranty: 



### Air Filter

P/N: 68198996AA  
 Price: \$75.00  
 Application: Replacement air filter for 3.6L cold air intake kit  
 P/N: 77070045AB  
 Warranty: 



### Air Filter

This filter offers high flow and low restriction, better throttle response, and increased filtration and horsepower. Filters are made of a dry media material and are washable and reusable. Do not oil dry media filters.

P/N: 77070013  
 Price: \$75.00  
 Application: USED TO SERVICE KIT P/N: 77060007, 77060013AB, 77060021 & 77060080  
 Warranty: 





### Air Filter

This filter offers high flow and low restriction, better throttle response, and increased filtration and horsepower. Filters are made of a dry media material and are washable and reusable. Do not oil dry media filters.

P/N: 77070014  
 Price: \$75.00  
 Application: USED TO SERVICE KIT P/N: 77060008 & 77060020AB  
 Warranty: 



### Air Filter

This filter offers high flow and low restriction, better throttle response, and increased filtration and horsepower. Filters are made of a dry media material and are washable and reusable. Do not oil dry media filters.

P/N: 77070015  
 Price: \$65.00  
 Application: USED TO SERVICE KIT P/N: 77060012AB  
 Warranty: 



### Air Filter

This filter offers high flow and low restriction, better throttle response, and increased filtration and horsepower. Filters are made of a dry media material and are washable and reusable. Do not oil dry media filters.

P/N: 77070017  
 Price: \$73.00  
 Application: USED TO SERVICE KIT P/N: P4510921AB  
 Warranty: 



### Air Filter

This filter offers high flow and low restriction, better throttle response, and increased filtration and horsepower. Filters are made of a dry media material and are washable and reusable. Do not oil dry media filters.

P/N: 77070018  
 Price: \$70.00  
 Application: USED TO SERVICE KIT P/N: 77060081 & 77070002  
 Warranty: 



### Air Filter

This filter offers high flow and low restriction, better throttle response, and increased filtration and horsepower. Filters are made of a dry media material and are washable and reusable. Do not oil dry media filters.

P/N: 77070019  
 Price: \$66.00  
 Application: USED TO SERVICE KIT P/N: 77070005  
 Warranty: 



### Air Filter

This filter offers high flow and low restriction, better throttle response, and increased filtration and horsepower. Filters are made of a dry media material and are washable and reusable. Do not oil dry media filters.

P/N: 77070038  
 Price: \$61.00  
 Application: USED TO SERVICE KIT P/N: 77070029 & 77070032  
 Warranty: 



### Air Filter

This filter offers high flow and low restriction, better throttle response, and increased filtration and horsepower. Filters are made of a dry media material and are washable and reusable. Do not oil dry media filters.

P/N: 77070010  
 Price: \$66.00  
 Application: USED TO SERVICE KIT P/N: 77060003AC, 77060006AB, 77060010AB, 77060011AB, 77070008, 77070029 & 77070032  
 Warranty: 





# DODGE CHALLENGER STREET DREAM BUILD

## PERFORMANCE

885 HP  
787 LBFT Torque  
0-60MPH: 3.4-sec.  
1/4 Mile: 10.8-sec.

## COMPONENTS

A. Hellcat Front Fascia Kit	\$1,995
B. Hellcat Stage 1 Kit	\$895
C. Redeye Cylinder Heads	\$2,595
D. Redeye Piston & Rod Kit	\$3,195
E. 2019 Hellcat Hood	\$1,495
F. Widebody Fender Flare Kit	\$2,495
G. Air Catcher Headlamp Kit	\$1,675
H. Redeye High-Flow Air Box	\$565
I. Redeye Torque Converter	\$1,235
J. Redeye Driveline Kit	\$4,955
K. Zero Camber Rear Knuckles	\$695
<b>Total Cost</b>	<b>\$21,795</b>





## Full Sweep Electric Performance Gauges

Powered by digital microprocessor-controlled, rugged stepper motor drives and laboratory-grade sending units, full sweep electric gauges are the best gauges available. They combine extreme durability and readability of 270-degree sweep mechanical gauges with the easy installation and safe operation of short sweep electrics.

Track-tested and race-proven, these units use precision senders to keep hazardous fluids out of the driver compartment, perform gauge calibration and sensor diagnostics at power up for extreme accuracy every time. Most units are compatible with the Auto Meter data logger for the ultimate race info center. Application for all full sweep electric performance gauges is universal.



**Boost Vacuum Gauge**  
P/N: 77060031  
Price: \$81.00  
Warranty:



**Water Temperature Gauge**  
P/N: 77060038  
Price: \$93.00  
Warranty:



**Fuel Level Gauge**  
P/N: 77060042  
Price: \$165.00  
Warranty:



**Tachometer Gauge w/Shift Light**  
P/N: 77060059  
Price: \$274.00  
Warranty:



**Boost Vacuum Gauge**  
P/N: 77060060  
Price: \$251.00  
Warranty:



**Tachometer Gauge**  
P/N: P5155500  
Price: \$402.00  
Warranty: No warranty, sold as-is



**Fuel Level Gauge**  
P/N: 77060043  
Price: \$159.00  
Warranty:



**Pyrometer Gauge**  
P/N: 77060046  
Price: \$222.00  
Warranty:



**Water Temperature Gauge**  
P/N: 77060052  
Price: \$196.00  
Warranty:



**Oil Pressure Gauge**  
P/N: P5155501  
Price: \$334.00  
Warranty: No warranty, sold as-is



**Water Temperature Gauge**  
P/N: P5155502  
Price: \$240.00  
Warranty: No warranty, sold as-is



**Oil Temperature Gauge**  
P/N: P5155503  
Price: \$240.00  
Warranty: No warranty, sold as-is



**Water Temperature Gauge**  
P/N: 77060053  
Price: \$196.00  
Warranty:



**Speedometer Gauge**  
P/N: 77060054  
Price: \$331.00  
Warranty:



**Speedometer Gauge**  
P/N: 77060055  
Price: \$331.00  
Warranty:



**Trans Temperature Gauge**  
P/N: P5155885  
Price: \$240.00  
Warranty: No warranty, sold as-is



**Tachometer Gauge**  
P/N: 77060056  
Price: \$226.00  
Warranty:



**Tachometer Gauge**  
P/N: 77060057  
Price: \$226.00  
Warranty:



**Tachometer Gauge w/Shift Light**  
P/N: 77060058  
Price: \$283.00  
Warranty:





## Mechanical Performance Gauges

Bronze Bourdon tube, 270-degree sweep movements, and durable nylon gearing have made these rugged and long-lasting gauges a proven high-performance favorite for more than 25 years. These mechanical gauges require no electrical power for operation, which makes them an ideal choice for vehicles with no or low-powered electrical systems. Application for all mechanical performance gauges is universal.



**Boost Vacuum Gauge**

P/N: 77060030

Price: \$96.00

Warranty:



**Boost Vacuum Gauge**

P/N: 77060032

Price: \$102.00

Warranty:



**Boost Vacuum Gauge**

P/N: 77060033

Price: \$102.00

Warranty:



**Oil Pressure Gauge**

P/N: 77060034

Price: \$93.00

Warranty:



**Oil Pressure Gauge**

P/N: 77060035

Price: \$93.00

Warranty:

## Short Sweep Electric Performance Gauges

Advanced 90-degree air core movements and simple three-wire installation characterize these high-performance instruments. Electrical signals collect data generated from hazardous fluids in the engine compartment to ensure precision. It's all the information you need – and nothing you don't. Application for all short sweep electric performance gauges is universal.



**Oil Pressure Gauge**

P/N: 77060044

Price: \$115.00

Warranty:



**Oil Pressure Gauge**

P/N: 77060045

Price: \$115.00

Warranty:



**Trans Temperature Gauge**

P/N: 77060048

Price: \$193.00

Warranty:



**Voltmeter Gauge**

P/N: 77060050

Price: \$83.00

Warranty:



**Voltmeter Gauge**

P/N: 77060051

Price: \$83.00

Warranty:



**Voltmeter Gauge**

P/N: P5155504

Price: \$118.00

Warranty: No warranty, sold as-is

## Dual Gauge Pod

This gauge pod from Direct Connection is available for the popular 2 1/16" gauges. Premium-grade automotive ABS is formed and trimmed to perfectly fit each application, giving a clean, factory look. Easy installation, with little or no modifications to the vehicle's interior. Not recommended for vehicles equipped with an A-pillar mounted air bag.

P/N: 77060062

Price: \$98.00

Application: 2004-2008 Dodge Charger and Magnum, and Chrysler 300

Warranty:



## Suspension

### Zero Camber Rear Knuckles

Specially designed for reduced camber gain, these rear knuckles increase the rear tire contact patch for improved traction during launches.

P/N: 77072544AB

Price: \$695.00

Application: 2008+ Dodge Charger/Challenger 5.7L/6.4L/6.2L SRT Hellcat, 2008+ Chrysler 300 5.7L, 2008-2010 Dodge Challenger 6.1L

Warranty:



### Strut Tower Brace, Front

This transverse-mounted horizontal strut tower brace will enhance structural rigidity, steering response, directional stability and vehicle handling. Made of heavy-duty steel and supplied with all applicable mounting hardware. Not compatible with vehicles equipped with "Shaker" Hood Scoop or SRT Hellcat engines.

P/N: P5155950

Price: \$375.00

Application: 2008-2021 Dodge Challenger 5.7L/6.1L/6.4L, 2006-2021 Dodge Charger 5.7L/6.1L/6.4L, 2005-2021 Chrysler 300 5.7L/6.1L, 2005-2008 Dodge Magnum 5.7L/6.1L

Warranty: No warranty, sold as-is







### Strut Tower Brace, Rear

This transverse-mounted horizontal strut tower brace will enhance structural rigidity, steering response, directional stability and vehicle handling. Made of heavy-duty steel and supplied with all applicable mounting hardware.

P/N: P5155951AB

Price: \$525.00

Application: 2011-2021 Dodge Challenger 3.6L/5.7L/6.2L/6.4L

2005-2021 Dodge Charger 3.6L/5.7L/6.2L/6.4L

2011-2021 300 3.6L/5.7L/6.2L/6.4L

Warranty: No warranty, sold as-is



### Strut Tower Brace, Front

Front strut tower brace for Shaker equipped vehicles. Strengthens the chassis as much as it makes your engine compartment look cool.

P/N: P5160082AB

Price: \$425.00

Application: 2014-2021 Dodge Challenger 5.7L/6.4L w/Shaker Hood

Warranty: No warranty, sold as-is



### Shock Tower Cap

Shock tower caps – billet aluminum (set of 2). Used with front strut tower brace P/N: P5155950. Will not fit 6.2L Supercharged.

P/N: 77072464

Price: \$165.00

Application: 2011-2021 Dodge Challenger, 2005-2021 Dodge Charger, 2011-2021 Chrysler 300

Warranty: 



### Strut Tower Brace, Front and Rear

Strut tower brace kit that includes front strut tower brace (P/N: P5155950) and rear strut tower brace (P/N: P5155951AB). Not compatible with vehicles equipped with “Shaker” hood scoop or SRT® Hellcat engines.

P/N: P5155983

Price: \$775.00

Application: 2015-2021 Dodge Challenger 5.7L/6.4L,

2005-2021 Dodge Charger 5.7L/6.4L,

2011-2021 Chrysler 300 5.7L/6.4L

Warranty: No warranty, sold as-is



### Anti-Sway Bars

Anti-sway bars improve steering response and handling. These bars are recommended for use with the Stage 3 Coil-Over Lowering Kit (P/N: P5155942). Front 31.75 mm solid and rear 19.05 mm solid. Includes bushings.

P/N: P5155239

Price: \$525.00

Application: 2008-2021 Dodge Challenger 5.7L/6.1L

Warranty: No warranty, sold as-is



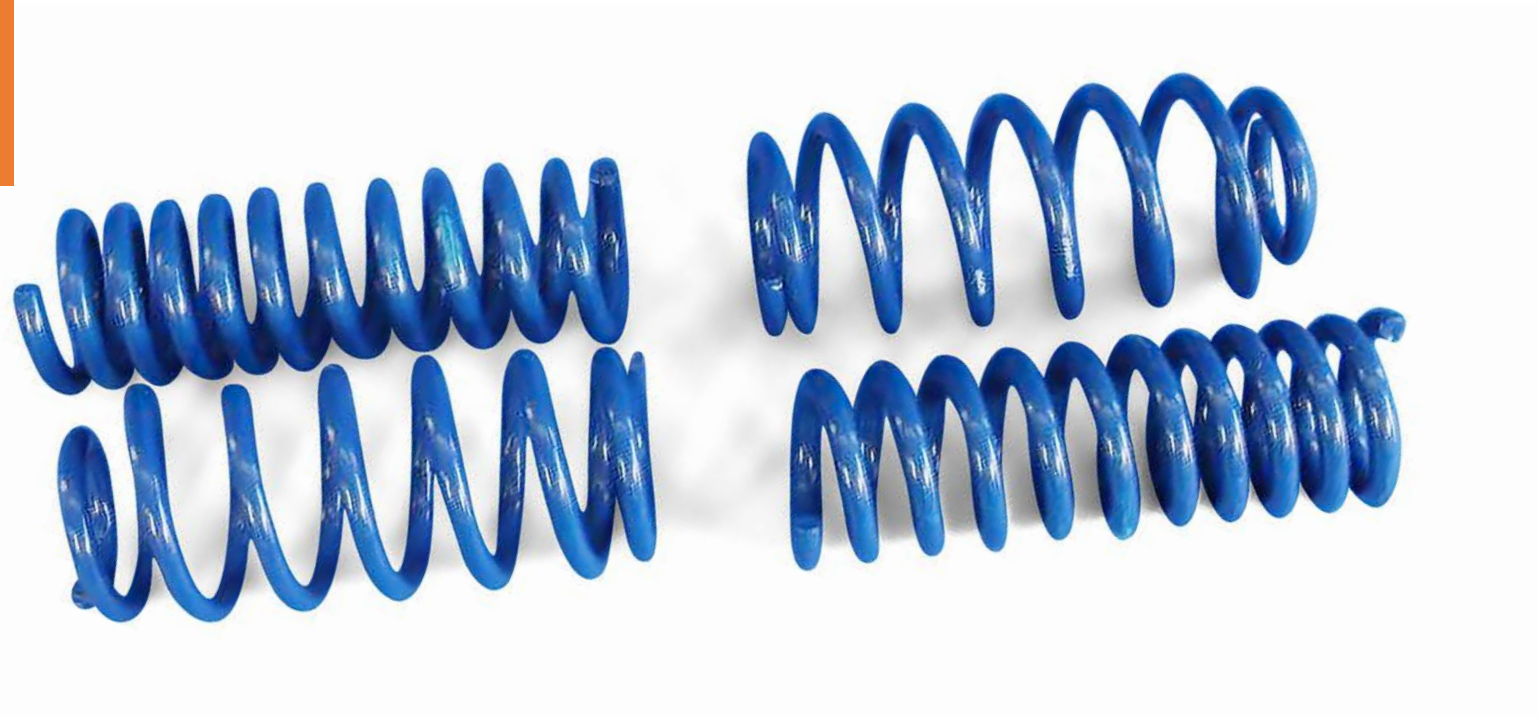

### Suspension Lowering Kit

This Stage 1 lowering spring kit is for Dodge Charger and Chrysler 300 owners who desire a sporty, yet comfortable ride. They reduce ride height 1.0" for that low, custom look. The high-tensile spring material ensures durability. Set of four. Not compatible with adaptive suspension or Nivomat shocks.

P/N: P4510854

Price: \$327.00

Application: 2008-2021 Dodge Charger, 2006-2021 Chrysler 300

Warranty: No warranty, sold as-is



### Super Track Pack Stage 2 Suspension Kit

Enhance your driving experience by installing an upgraded suspension package. Package contains springs, shocks, shock isolators and jounce bumpers. Depending on vehicle configuration, the Super Track Pack Suspension Package may provide up to a 0.5 reduction in ride height. For 3.6L and 5.7L vehicles not equipped with the Super Track Pack option.

P/N: P5155435AD

Price: \$629.00

Application: 2011-2021 Dodge Challenger & Charger RWD – non-SRT®, 2011-2021 Chrysler 300 RWD – non-SRT

Warranty: No warranty, sold as-is



## Strut Tower Brace, Front

Made of heavy-gauge powdercoated steel, this MIG welded Direct Connection strut tower brace reduces body flex in the front end, improving handling and drivability. Easy bolt-on installation.

P/N: P4510543  
 Price: \$189.00  
 Application: 2003-2005 Dodge Neon SRT4  
 Warranty: No warranty, sold as-is



## Strut Tower Brace, Rear

Made of heavy-gauge powdercoated steel, this MIG welded Mopar Performance strut tower brace reduces body flex in the rear end, improving handling and drivability. Easy bolt-on installation.

P/N: P4510876  
 Price: \$188.00  
 Application: 2003-2005 Dodge Neon SRT4  
 Warranty: No warranty, sold as-is



## Adjustable Control Arm, Rear

Direct Connection Neon SRT4 rear adjustable control arms offer you more adjustment for the rear of your SRT4 Neon than stock. They feature steel construction with rubber bushings and offer an extended toe adjustment range.

P/N: P4510870  
 Price: \$133.00  
 Application: 2000-2005 Dodge Neon 2.0L/2.4L & SRT4  
 Warranty: No warranty, sold as-is



## Suspension Springs

Made of high-tensile spring material to ensure durability and heighten spring performance without bind. Also provides a 25 mm drop from the stock ride height. Full vehicle set.

P/N: P4510458  
 Price: \$264.00  
 Application: 2003-2005 Dodge Neon SRT4  
 Warranty: No warranty, sold as-is

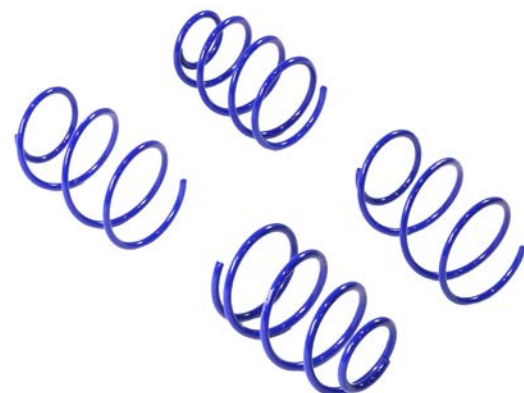

## Wheels

### Lightweight Forged Aluminum Wheels

20 X 9" X 22.5 mm Low Gloss Granite Crystal painted lightweight forged aluminum performance wheel offers up to an 8-lb. weight savings per factory wheel and features "Mopar" and "Lightweight" embossing.

P/N: 77070063AC  
 Price: \$675.00  
 Application: 2015-2021 Dodge Charger & Challenger  
 Warranty: 





# VINTAGE MUSCLE

AIR & FUEL	86
BRAKES	87
DRIVETRAIN	88
ENGINE PARTS	90
EXTERIOR	104
SUSPENSION	104





## Air & Fuel

### Fuel Pump Eccentric

The moly coating on this fuel pump eccentric significantly reduces friction and wear.

P/N: P4120484

Price: \$38.75

Application: Small block V8 engines 273/318/340/360

Warranty: No warranty, sold as-is



### Intake Manifold

Back by popular demand – the original 1966-1971 street in-line, dual quad intake manifold. Uses original Carter AFB carburetors and maintains mounting bosses for throttle return brackets. Features factory casting numbers along with the Chrysler Pentastar logo. Designed specifically for the 426 Street HEMI® engine.

P/N: P5153737

Price: \$488.00

Application: 426 Street HEMI

Warranty: No warranty, sold as-is

### Intake Manifold Big Block

Performance dual-plane aluminum intake manifold for 413/426/440 RB engines.

P/N: 77070017

Price: \$73.00

Application: USED TO SERVICE KIT P/N: P4510921AB

Warranty: No warranty, sold as-is



## Brakes



### Master Cylinder Adapter

Converts from four-stud to two-stud attaching style. For use with Mopar® brake cylinder pushrod Package (P/N: P5249316AB).

P/N: P5249315

Price: \$45.15

Application: For use with Mopar brake cylinder pushrod package (P/N: P5249316AB)

Warranty: No warranty, sold as-is



### Brake Pushrod

For use with Mopar® lightweight master cylinder assemblies (P/N: P5249270 and P5249271 which are currently discontinued).

P/N: P4510640

Price: \$75.00

Application: For use with Mopar lightweight master cylinder assemblies

Warranty: No warranty, sold as-is



## Drivetrain



## Neutral Safety Switch

Direct Connection neutral safety switches prevent your engine from being started unless the transmission is in neutral or park. These switches work by disabling the starting circuit when the transmission is in gear, preventing the accidental starting of your vehicle and avoiding personal injury and vehicle damage. Don't take chances with a bad safety switch – replace it with a new one.

P/N: P5007747

Price: \$11.45

Application: 1985-Present A-727/A-904 (short) automatic transmission

Warranty: No warranty, sold as-is



## Bearing Set

Specifically designed to eliminate production bearing retainers and axle end play adjuster. Set contains two axle shaft bearings, two bearing retainer sleeves, two axle shaft seals and two axle flange gaskets. For drag racing use only.

P/N: P5249444

Price: \$148.00

Application: 1965 and Newer 8-3/4" and 9-3/4" axles

Warranty: No warranty, sold as-is





# ENGINE PARTS

## Covers & Hardware

### Breather Cap

For use with Mopar® cast aluminum valve covers to fill extra valve cover holes. Push-in-style breather cap requires the use of grommet set P/N: P4529882.

P/N: P4120446

Price: \$25.90

Application: Small block V8 engines 273/318/340

Warranty: No warranty, sold as-is



### Breather Cap

Breather cap, push-in style, chrome.

P/N: P4529881

Price: \$9.75

Application: Big block V8 engines

Warranty: No warranty, sold as-is



### Valve Cover Breather Cap

For use with Mopar cast aluminum valve covers to fill extra valve cover holes.

P/N: P4529880

Price: \$9.75

Application: Small block V8 engines

Warranty: No warranty, sold as-is



### Valve Cover Hardware

For stamped steel valve covers only. Accessory kit includes 12 chrome-plated screws and washers, one chrome-plated oil filter cap and two rubber grommets.

P/N: P4120272AB

Price: \$21.10

Application: Big block or small block, stamped steel valve covers

Warranty: No warranty, sold as-is



### Timing Chain Cover

Includes cover, seal and gasket.

P/N: P4349816AB

Price: \$54.00

Application: Big block and 426 HEMI®

Warranty: No warranty, sold as-is



## Engine Cooling

### Radiator Fan Shroud – 26”

Fan shroud, radiator, 1967-1969 426 HEMI® engine, 383/440 big block B-body, five-stud mounting, restoration.

P/N: P2785434

Price: \$162.00

Application: 1967-1969 426 HEMI engine, 383/440 big block B-bodies

Warranty: No warranty, sold as-is



### Fan Shroud

Fan shroud, radiator, 1970-1973 426 HEMI engine, 383/440 big block B/E-bodies, four-screw mounting shown, restoration.

P/N: P2998326

Price: \$162.00

Application: 1970-1973 426 HEMI engine, 383/440 big block B/E-bodies

Warranty: No warranty, sold as-is



### Thermostat Housing

This high-quality chrome thermostat housing is made of heavy-duty material. Includes gasket and two chrome bolts.

P/N: P4286759AB

Price: \$20.45

Application: Big block engines 1978 and Prior, small block LA engines

Warranty: No warranty, sold as-is



## Engine Electrical & Controllers

### Voltage Regulator

To ensure your ignition and electrical systems can provide maximum performance, install a constant output voltage regulator. Voltage is held at a constant 13.5 volts. For race applications only.

P/N: P3690732

Price: \$67.15

Application: Up to 1969, V8, race

Warranty: No warranty, sold as-is



### Voltage Regulator

To ensure your ignition and electrical systems can provide maximum performance, install a constant output voltage regulator. Voltage is held at a constant 13.5 volts. For race applications only.

P/N: P3690731

Price: \$57.15

Application: 1970 and Newer, V8, race

Warranty: No warranty, sold as-is





## Voltage Regulator

For restoration or repair, Direct Connection offers this factory reissue of the voltage regulator as used on muscle cars of the early 1970s. The regulator is black with the original Mopar part number imprinted in yellow. Contains modern electronics.

P/N: P4529794

Price: \$75.75

Application: 1970-1983 Muscle Car, O.E.

Warranty: No warranty, sold as-is



## Voltage Regulator

For restoration or repair, Direct Connection offers this factory reissue of the voltage regulator as used on muscle cars of the early 1970s. The regulator is black with the original Mopar part number imprinted in yellow. Contains modern electronics.

P/N: 77R06285

Price: \$80.00

Application: 318/380/400 V8 engines

Warranty: No warranty, sold as-is



## Voltage Regulator

For restoration or repair, Direct Connection offers this factory reissue of the voltage regulator as used on muscle cars of the early 1970s. The regulator is black with the original Mopar part number imprinted in yellow. Contains modern electronics.

P/N: 77R06286

Price: \$80.00

Application: 1970-1983, big block & small block LA V8 engines

Warranty: No warranty, sold as-is



## Hold Down Clamp

Under the hood, every detail matters, and chrome is the perfect enhancement. Add to your under hood atmosphere with heavy-duty chrome distributor hold-down clamps and chrome-plated bolts. Sold individually.

P/N: P4349279

Price: \$33.90

Application: Big block V8 engines

Warranty: No warranty, sold as-is



## Distributor Hold Down Clamp

Under the hood, every detail matters, and chrome is the perfect enhancement. Add to your under hood atmosphere with heavy-duty chrome distributor hold-down clamps and chrome-plated bolts. Sold individually.

P/N: P4349278

Price: \$14.60

Application: Small block A-engines

Warranty: No warranty, sold as-is



## Distributor Cap

Replacement for the original tan-colored distributor cap used in Chrysler high-performance V8 muscle cars of the late 1960s and early 1970s.

Sold individually.

P/N: P4529791

Price: \$24.30

Application: Small block V8 engines 273/318/340/360

Warranty: No warranty, sold as-is

## Spark Plug Wire Set

Just like O.E., carbon suppression wires are manufactured in the right color with the right lettering and each includes the correct spark plug boot. Set contains eight ignition secondary wires and one coil wire.

P/N: P4529797

Price: \$45.15

Application: Small block 340 V8 engine

Warranty: No warranty, sold as-is



## Plug Tube & Seal Set

Includes eight special spark plug tubes and tube seals, as used on 426 HEMI® engines.

P/N: P4120294

Price: \$115.00

Application: 426/472/528 HEMI engines

Warranty: No warranty, sold as-is



## Gaskets & Hardware

## Valve Cover Breather Baffle

Baffle and screw package, big block, small block, 5.2L/5.9L Magnum V8 engines.

P/N: P5007052

Price: \$9.75

Application: Big block, small block, 5.2L/5.9L Magnum V8 engines

Warranty: No warranty, sold as-is





## Valve Lash Chart

Valve lash adjustment decal for HEMI® engine, big blocks, small blocks, 5.2L/5.9L Magnum V8 engines.

P/N: P4452989

Price: \$4.55

Application: HEMI engine, big block, small block, 5.2L/5.9L Magnum V8 engines

Warranty: No warranty, sold as-is



## Valve Cover Bolts

Fit 5.2L/5.9L Magnum valve cover packages P/N: P5007617 and P5007618.

Designed for cast aluminum valve covers only. Set includes 20 bolts (ten per cover).

P/N: P5007620

Price: \$43.60

Application: Small block, 5.2L/5.9L Magnum V8 engines

Warranty: No warranty, sold as-is



## Flex Plate Bolt Package

Includes six crank bolts and four converter bolts.

P/N: P4876820

Price: \$35.60

Application: Small block V8 engines 273/318/340, big block V8 engines 413/440/426, Slant Six, 3.9L V6 engines

Warranty: No warranty, sold as-is



## Torque Converter Bolt Set

Includes four bolts to attach torque converter to the flex plate.

Available for both eight- and six-cylinder engines.

P/N: 01949765

Price: \$4.45

Application: V8 & six-cylinder engines w/TorqueFlite® 727, 904 automatic transmissions

Warranty: No warranty, sold as-is



## Camshaft Sprocket Hardware Package

Required when a fuel pump eccentric is used.

P/N: P4529838

Price: \$17.90

Application: Small block V8 engines 273/318/340/360

Warranty: No warranty, sold as-is



## Oil Pan Set

Bolt set, oil pan, 426 HEMI® engine, big block, Small block, set of 20 bolts.

P/N: P4120613

Price: \$14.60

Application: Small block, big block & 426 HEMI engines

Warranty: No warranty, sold as-is



## Oil Pan Gasket

For big block and HEMI engine applications. Note that two are required for windage tray applications.

P/N: P3412049

Price: \$14.60

Application: Big block & 426 HEMI engine, V8 engines

Warranty: No warranty, sold as-is



## Transmission Gasket

All the parts you need for changing the fluid in your automatic transmission.

P/N: P3690855

Price: \$9.75

Application: A-727 automatic transmission

Warranty: No warranty, sold as-is



## Torsion Bar Lock and Seal

Lock clips and seals for Mopar® torsion bars for A-body, B-body (1962-1972) and E-body vehicles.

P/N: P1671446

Price: \$2.15

Application: A/B/E-bodies

Warranty: No warranty, sold as-is







### Water Pump Installation Kit

Includes water pump gasket, pump housing gasket, plugs, water pump bolts, plus long and short housing bolts.

P/N: P5007449  
 Price: \$43.60  
 Application: Big block V8 engines  
 Warranty: No warranty, sold as-is



### Damper Degree Timing Tape

Improve timing accuracy with this damper degree timing tape. Marked in 90° increments. Self-adhesive strip adheres to the crank vibration damper for clear identification of marks. Permits initial total spark advance up to 60° instead of only 10°-15° as on chain case timing tab.

P/N: P4529070AB  
 Price: \$9.75  
 Application: Universal  
 Warranty: No warranty, sold as-is

## Oiling Systems & Parts

### Distributor Drive Gear Assembly

Distributor drive gear, HD.

P/N: P3690715  
 Price: \$70.00  
 Application: 3.9L V6 & small block V8 engines  
 Warranty: No warranty, sold as-is



### Distributor Drive Gear, Flat Tappet Cams

Distributor drive gear, flat tappet cams feature a hardened tip shaft with full radius blend from hex to round and pinned gears.

P/N: P3571071  
 Price: \$106.00  
 Application: Big block & 426 HEMI® V8 engines  
 Warranty: No warranty, sold as-is



### Distributor Drive Gear

Distributor drive gear, roller cam features a hardened tip shaft with full radius blend from hex to round and pinned gears.

P/N: P3690875  
 Price: \$165.00  
 Application: Big block & 426 HEMI V8 engines  
 Warranty: No warranty, sold as-is



### Distributor Drive Gear

Distributor drive gear, roller cam features a hardened tip shaft with full radius blend from hex to round and pinned gears.

P/N: P3690874  
 Price: \$280.00  
 Application: Small block V8 engines  
 Warranty: No warranty, sold as-is





## Oil Pump

This high-output oil pump assembly provides a 25% increase in oil volume. Ideal replacement for stock pump in high-performance applications.

P/N: P4286589

Price: \$95.00

Application: 3.9L V6 & small block V8 engines 273/318/340/360

Warranty: No warranty, sold as-is



## High-volume Oil Pump

This high-output assembly provides a 25% increase in oil volume. Ideal replacement for stock pump in high-performance applications.

P/N: P4286590

Price: \$121.00

Application: Application: Big block & 426 HEMI® GENII V8 engines

Warranty: No warranty, sold as-is



## Oil Pump Priming Shaft

Special hardened steel priming shaft fits on any 3/8" or larger drill. Insert shaft into hole where distributor fits. Pressurizes oil galleries to ensure against dry starts and engine damage.

P/N: P4286800

Price: \$10.00

Application: 3.9L V6, 5.2L/5.9L Magnum V8 engines, small block & big block V8 engines

Warranty: No warranty, sold as-is



## High Performance Oil Filter

Engineered to meet the demands of heavy-duty and high-performance applications. Filter is black with Mopar® Performance Pentastar logo.

P/N: P4452890

Price: \$11.45

Application: Slant Six, 3.9L V6 engines, small block A-engines, big block V8 engines

Warranty: No warranty, sold as-is



## Oil Pickup and Screen

Oil pickup and screen assembly, center sump pans PN: P5249059 and P5249061 (small block).

P/N: P4529563

Price: \$35.80

Application: Small block V8 engines

Warranty: No warranty, sold as-is



## Oil Pressure Relief Spring

Increases engine oil pressure over stock spring for high-performance applications. Delivers up to 70 lbs. of oil pressure. Includes a cap and instructions.

P/N: P4286571

Price: \$6.60

Application: Slant Six & big block V8 engines

Warranty: No warranty, sold as-is



## Oil Pressure Relief Spring

Increases engine oil pressure over stock spring for high-performance applications. Delivers up to 70 lbs. of oil pressure. Includes a cap and instructions.

P/N: P3690944

Price: \$6.60

Application: 4 and 6-cylinder engines & small block V8 engines

Warranty: No warranty, sold as-is





## Dipstick

Dipstick and tube, chrome, center sump pan, small block passenger cars.

P/N: P4349628

Price: \$22.65

Application: Small block V8 engines

Warranty: No warranty, sold as-is



## Dipstick and Tube

Dipstick with chrome tube for big block B/RB engines.

P/N: P4349629

Price: \$22.65

Application: Big block V8 engines

Warranty: No warranty, sold as-is



## Intermediate Shaft Bushing

Intermediate shaft bushing, V6 and V8.

P/N: P1737725

Price: \$9.75

Application: V6, small block & big block V8 engines

Warranty: No warranty, sold as-is



## Valvetrain & Cylinder Heads



## Cylinder Head

Designed for more power. Stiffer and stronger than original, increased material permits porting for improved airflow. Features the same outward appearance as the original 1966-1971 heads, except for shape of alternator boss. All components attach the same as original (intake and exhaust valves, valve guides, seats, rocker gear, etc.). Features 170cc combustion chamber and 2.25" intake and 1.94" exhaust valve machining. Sold individually.

P/N: P4876855

Price: \$1,455.00

Application: 1966-1971 426 HEMI® V8 Engine

Warranty: No warranty, sold as-is



## 426 Aluminum Head Assembly

Interchangeable with production cast iron head and offers a weight reduction of 50 lbs. per engine set. Features include single plug per cylinder (capability for dual), common 2.25" intake and 1.94" exhaust valve machining, 170cc combustion chamber, valve seats and guide inserts. Includes valves, springs, retainers and keepers. Sold individually.

P/N: P5153779

Price: \$1,300.00

Application: 1966-1971 426 HEMI V8 engine

Warranty: No warranty, sold as-is



## Hydraulic Tappet

Sold individually.

P/N: P3614321AB

Price: \$8.95

Application: Small block V8 engines

Warranty: No warranty, sold as-is



## Hydraulic Tappet

Tappet, hydraulic, HEMI® engine/big block. Sold individually.

P/N: P4006767AB

Price: \$8.55

Application: Big block and 426 HEMI® V8 engines

Warranty: No warranty, sold as-is



## Rocker Shim Package

Use to improve adjustable rocker arm-to-valve tip alignment, 0.015" thick. For 426 HEMI engine.

Rocker arm spacer set, 0.015" thick, .878" I.D., 1.246" O.D. Set of 12.

P/N: P3690896

Price: \$13.60

Application: 426 HEMI® V8 engines

Warranty: No warranty, sold as-is



## Timing Chain and Gear Set

Chain, double, roller with sprockets, one-bolt mount, three matched keyways, small block, 5.2L/5.9L Magnum V8 engines.

P/N: P5249267

Price: \$80.00

Application: Small block, 5.2L/5.9L Magnum V8 engines

Warranty: No warranty, sold as-is



## Performance Valve Spring Retainer

These single-groove-style HEMI® engine split locks are made from hardened material. They feature a 5/16" stem diameter and can be used for restoration or performance applications. Sold as cylinder head sets of 16 pieces. Note that two sets are required for all V8 engines. For 426-based HEMI® engine.

P/N: P4529288

Price: \$14.50

Application: 426 HEMI® V8 engine

Warranty: No warranty, sold as-is



## Dual Valve Spring

High-pressure valve springs can be used on exhaust and intake valves for all high-performance applications. They feature a shorter fully-compressed height and allow for increased valve lift. Springs maintain spring load at higher rpms – a must for high-performance cams. Sold individually. With a single spring, the damper is installed inside the main spring; with a dual spring, the damper is installed between the inner and outer springs. There are no dampers in the triple springs. The retainers listed are the basic recommendation. Check the actual retainer listing for other options: added installed height, materials and lock size. For 426-based HEMI® engine.

P/N: P4876064

Price: \$15.15

Application: 426 HEMI V8 engine, 0.590"/0.640" lift

Warranty: No warranty, sold as-is



## Single Valve Spring w/Damper

High-pressure valve springs can be used on exhaust and intake valves for all high-performance applications. They feature a shorter, fully-compressed height and allow for increased valve lift. Springs maintain spring load at higher rpms, a must for high-performance cams. Sold individually. With a single spring, the damper is installed inside the main spring; with a dual spring, the damper is installed between the inner and outer springs. There are no dampers in the triple springs. The retainers listed are the basic recommendation. Check the actual retainer listing for other options: added installed height, materials and lock size.

P/N: P4876062

Price: \$10.70

Application: 5.2L/5.9L Magnum V8 engines, up to 0.600" lift

Warranty: No warranty, sold as-is



## Intake Valves

Quantity of 1, each stainless valve has swirl-polished underheads with no flat or ski jump areas. Each features a 3/8" stem diameter and one square groove. Valve dimensions are 2.02" diameter, 4.91" stem length.

P/N: P5249878

Price: \$24.15

Application: 3.9L V6 engines, 5.2L/5.9L Magnum V8 engines

Warranty: No warranty, sold as-is





Exterior

Red Side Market Lens

Reproduction of the original rear side marker lamp lens designed for use on 1972-1976 A-body, 1972-1975 B-body and 1972-1974 E-body Mopar® models. This reproduction lens will fit and install same as original. For use on the rear quarter panel. Includes replacement gasket for installation. Sold individually.



P/N: 03587440  
 Price: \$26.60  
 Application: 1972-1976 A-body, 1972-1975 B-body and 1972-1974 E-body  
 Warranty: No warranty, sold as-is

Suspension

Frame Connector

These prefabricated bolt-in frame connector packages let you tie the front and rear frame longitudinally on all A-, B- or E-body drag cars. They can be welded for additional strength and rigidity. Packages include two connectors, brackets and necessary mounting hardware.



P/N: P4876658  
 Price: \$218.00  
 Application: A-, B- and E-body cars  
 Warranty: No warranty, sold as-is

Pinion Snubber

Helps control axle windup by adjusting the height to the floor pan. Units fit to the center front of the rear axle housing.



P/N: P3690182  
 Price: \$80.00  
 Application: Vehicles with 8-3/4" axle  
 Warranty: No warranty, sold as-is

Shackle Bushings

For A-, B- or E-body vehicles. Available in high-performance polyurethane for improved vehicle handling, or factory-original equipment heavy-duty rubber for restoration projects. Sold in sets of eight bushings.



P/N: P4452987  
 Price: \$14.60  
 Application: A-, B- and E-body vehicles  
 Warranty: No warranty, sold as-is

Shock Absorber

Designed with the extended length required by special drag racing applications. Sold individually.



P/N: P4529514  
 Price: \$34.75  
 Application: A-body drag cars  
 Warranty: No warranty, sold as-is

Rear Spring Mounting Seat

When installing a leaf spring suspension, use these rear spring mounting seats. These seats work with all 3-inch diameter tube rear axles (8-1/4", 8-3/4", 9-1/4", 9-3/4").



P/N: P4120074  
 Price: \$11.45  
 Application: All 3" diameter tube rear axles (8-1/4", 8-3/4", 9-1/4", 9-3/4")  
 Warranty: No warranty, sold as-is



## Competition Leaf Springs

Designed to control torque roll, providing equal bite on rear wheels through limited axle windup. These springs don't lock up the rear, but allow it to move, keeping the tires on the track where they belong. The rear springs listed below have a 20-inch front segment and require a longer front spring hanger bracket for B-, E-, F-, J- and M-bodies (not included). Standard hanger brackets used on A-body. When P/N: P3412002/03 is used on a B- or E-body frame, the rear spring eye in the frame must be relocated forward: Pinion snubber is recommended. If using P/N: P4120863, vehicle will not be level at standstill.



**Leaf Spring**  
 P/N: P4120864  
 Price: \$145.00  
 Application: A-body, driver side rear  
 Warranty: No warranty, sold as-is



**Leaf Spring**  
 P/N: P4120863  
 Price: \$145.00  
 Application: A-body, passenger side rear  
 Warranty: No warranty, sold as-is



**Leaf Spring**  
 P/N: P3690455  
 Price: \$150.00  
 Application: B-body, driver side rear  
 Warranty: No warranty, sold as-is



**Leaf Spring**  
 P/N: P3690454  
 Price: \$159.00  
 Application: B-body, passenger side rear  
 Warranty: No warranty, sold as-is



**Leaf Spring**  
 P/N: P3412003  
 Price: \$145.00  
 Application: 1968 HEMI® engine Super Stock A-body, B-body w/relocated shackle, driver side rear  
 Warranty: No warranty, sold as-is



**Leaf Spring**  
 P/N: P3412002  
 Price: \$143.00  
 Application: 1968 HEMI engine Super Stock A-body, B-body w/ relocated shackle, passenger side rear  
 Warranty: No warranty, sold as-is



**Leaf Spring**  
 P/N: P3690457  
 Price: \$152.00  
 Application: 1964-1965 Super Stock B-body  
 Warranty: No warranty, sold as-is

## XHD Leaf Springs

These extra heavy-duty O.E. leaf springs are just like the bias design production springs that were stock on 1968-1972 A-body vehicles with 340 high-performance engines, 1967-1971 B-body vehicles with 440 or 426 manual and automatic transmissions, and 1970-1974 E-body vehicles with 440 or 426 manual or automatic transmissions. Springs will fit any B-body (1966-1972) or E-body (1970-1974), regardless of engine size, and come with front bushings installed in assembly. B-body: front 22", rear 36". Select right or left spring.



**XHD Leaf Spring**  
 P/N: P4452982  
 Price: \$162.00  
 Application: O.E., 1966-1972 B-body, passenger side rear  
 Warranty: No warranty, sold as-is



**XHD Leaf Spring**  
 P/N: P4452983  
 Price: \$162.00  
 Application: O.E., 1966-1972 B-body, driver side rear  
 Warranty: No warranty, sold as-is



**XHD Leaf Spring**  
 P/N: P4452984  
 Price: \$152.00  
 Application: O.E., 1970-1974 E-body, passenger side rear  
 Warranty: No warranty, sold as-is



**XHD Leaf Spring**  
 P/N: P4452985  
 Price: \$153.00  
 Application: O.E., 1970-1974 E-body, driver side rear  
 Warranty: No warranty, sold as-is





## DIRECT CONNECTION PERFORMANCE PARTS LIMITED WARRANTIES & REGULATORY STATEMENTS

### NOTICE

Federal and many state laws prohibit the removal, modification or rendering inoperative of any part or element of design affecting emissions or safety on motor vehicles used for transporting persons or property on a public street or highway. Violation may result in a fine imposed for each vehicle impacted. Many performance parts listed in this catalog cannot be used on vehicles used on public streets or highways. These parts may be used only on vehicles used solely in sanctioned off-highway events. No other applications for these parts are intended or implied. Those parts that have been granted an exemption by the California Air Resources Board (CARB) or meet the EPA requirements of memorandum 1A are legal for highway use in California, New York and Massachusetts and are noted as such.

### Direct Connection HEMI® Crate Engine Kit Powertrain Limited Warranty

HEMI® crate engine kits are covered by a 3-Year/100,000-Mile Powertrain Limited (parts exchange only) Warranty. Crate Engine Controller kit must be purchased on the same invoice as the engine to qualify for the 3-Year/100,000-Mile Parts Exchange Warranty. Failure to provide proof of the installation kit with the engine will void the 3-Year/100,000-Mile Powertrain Warranty. Direct Connection HEMI crate engines would then be covered against defects in materials and workmanship for a 90-day period (parts exchange only).

### Direct Connection Parts Beginning with “770...” or “68...” Except HEMI Crate Engine Kits

Mopar® Basic Limited Warranty Except as noted below, Direct Connection Performance Parts beginning with “770...” installed by a Dodge Power Brokers Dealership are warranted against defects in workmanship or materials for 24 months/unlimited miles from date of purchase for both parts and labor. Direct Connection parts sold wholesale to an automotive service facility and installed by a professional technician are warranted against defects in workmanship or materials for 24 months/unlimited miles from date of purchase for parts and up to \$150.00 in labor. Direct Connection parts sold over-the-counter for vehicle owner or do-it-yourself installation are warranted against defects in workmanship or materials for 24 months/unlimited miles from date of purchase for parts exchange only. Direct Connection parts when installed/replaced by a Dodge Power Brokers Dealership on an FCA US LLC vehicle still covered by the FCA US LLC New Vehicle Basic Limited Warranty are warranted for the remainder of the 3-Year/36,000-Mile New Vehicle Basic Limited Warranty and the 5-Year/60,000-mile Powertrain limited warranty’ or the Direct Connection 24-Month Basic Limited Warranty from the original installation date, whichever is more favorable to the customer. **CUSTOMER MUST KEEP ORIGINAL RECEIPT.**

### Direct Connection Parts Beginning with “PW...”

Direct Connection PW Performance Parts Limited Warranty Direct Connection PW Performance Parts are those parts with a part number beginning in “PW” and do not include any other Performance Parts. Except as noted below, Direct Connection PW Performance Parts installed by a Dodge Power Brokers Dealerships are warranted against defects in workmanship or materials for 12 months/12,000 miles for both parts and labor from date of purchase. Direct Connection PW Performance Parts sold wholesale to an automotive service facility and installed by a professional technician are warranted against defects in workmanship or materials for 12 months/12,000 miles from date of purchase for parts and up to \$150.00 in labor. Direct Connection PW Performance Parts sold over-the-counter for vehicle owner or do-it-yourself installation are warranted against defects in workmanship or materials for 12 months/12,000 miles from date of purchase for parts exchange only. **CUSTOMER MUST KEEP ORIGINAL RECEIPT.**

### Direct Connection Parts Beginning with “P...” or “O...”

#### NO PARTS WARRANTY – “AS IS”

Direct Connection Parts with part numbers beginning with “P...” or “O...” are sold “as is” without warranty coverage of any kind by Direct Connection unless otherwise noted.

Direct Connection Gen II crate engine assemblies are warranted for “parts only” “as delivered” against defects in materials or workmanship for 90 days from the date of purchase.

The following covered components for Direct Connection engine assemblies, which prove to be defective in materials or workmanship, will be replaced on an exchange basis for 90 days: cylinder blocks and all internal parts; cylinder head assemblies; intake manifold; core plugs; valve covers; oil pan; timing gear and/or chain and cover; water pump; gaskets and seals.

#### PLEASE NOTE:

The limited warranty period starts on the day the part is sold, as reported on the sales receipt, to the consumer. The limited warranty is not transferable. When the vehicle is sold or otherwise disposed of (i.e., the vehicle is no longer titled in consumer’s name), the limited warranty ends. **CONSUMER MUST KEEP ORIGINAL RECEIPT.**

Implied warranties, such as warranties of merchantability, are excluded. (An implied warranty of merchantability means that the part is reasonably fit for the general purpose for which it was sold.) The entire risk as to quality and performance of such parts is with the buyer. Should such parts prove defective following their purchase, the buyer and not the manufacturer, distributor or retailer, assumes the entire cost of all necessary servicing or repair. Chrysler, Dodge, Jeep®, and Ram vehicle and parts warranties are voided if the vehicle or parts are used for competition. The addition of performance parts does not by itself void a vehicle’s warranty. However, added performance parts (parts not originally supplied on the vehicle from the factory) are not covered by the vehicle’s warranty, and any failure that they may cause is not covered by the vehicle’s warranty.

Direct Connection Limited Warranties do not cover any incidental or consequential damages connected with the failure of the part under warranty. Such damages include lost time, inconvenience, the loss of the use of your vehicle, the cost of rental cars, gasoline, telephone, travel or lodging; the loss of personal or commercial property; or the loss of revenue. Some states do not allow the exclusion or limitation of incidental or consequential damages, so the above limitations or exclusions may not apply to you.

Your warranties can also be restricted by FCA US LLC, as set forth in the New Vehicle Limited Warranty. If your New Vehicle Limited Warranty is restricted by FCA US LLC, coverage under your Direct Connection Parts and Accessories Limited Warranties may also be restricted or denied.

#### EMISSIONS STATEMENT

Direct Connection Performance customers are responsible for complying with applicable federal state and local environmental laws and regulations. Many Direct Connection Performance Parts and components are designed to be equipped in vehicles that are operated not on streets or highways (such as vehicles intended for competition or off-road use). Motor vehicles designed for transport on streets or highways and equipped with such parts may cause such motor vehicles to be out of compliance with applicable emissions standards. It may be a violation of federal and state law to operate such motor vehicles equipped with such parts, except where vehicles equipped with such parts are operated not on streets or highways and where such vehicles lack features customarily associated with safe and practical highway use.

If you install such parts on a motor vehicle, and your motor vehicle fails a required state or local inspection and maintenance (I/M) emissions test, including any test required to maintain or renew your motor vehicle’s registration, or if your motor vehicle is subject to an emissions recall, in either case, FCA US LLC may not be required to repair your motor vehicle under the emissions warranty, and you may be required to remove those parts and replace them with other parts at your own expense in order to obtain repairs necessary to pass the I/M emissions test or to ensure your motor vehicle is compliant with applicable emissions standards after the recall repair.



## HOW TO OBTAIN WARRANTY SERVICE

Where both parts and labor are covered in warranty items, repair will be made by any Dodge Power Brokers Dealership at no charge. Where parts only are covered, the Dodge Power Brokers Dealership will provide replacement parts at no charge. It is recommended that vehicles be taken to the selling dealership or to the dealer who sold or installed the Direct Connection Performance part or accessory. However, replacement parts or service under warranty may be obtained from any authorized Dodge Power Brokers Dealership.

### WHAT IS NOT COVERED:

Direct Connection warranties cover neither non-FCA US LLC or non-Direct Connection Parts, components or equipment. These warranties also do not cover the costs of any repairs or adjustments that might be caused by or needed because of the use or installation of any non-FCA US LLC or non-Direct Connection Parts, equipment, materials or additives.

Direct Connection warranties do not cover the costs of repairing damage or conditions caused by fire or accident; by abuse, negligence or misuse (for example: driving over curbs, or overloading or racing the vehicle); by improper adjustment, alteration or failure to maintain the vehicle on which parts are installed; or corrosion or damage caused by the use of caustic materials.

Direct Connection warranties do not cover parts installed on a vehicle used for racing or competition, nor do they cover the repair of any damage or conditions caused by racing or competition.

Direct Connection warranties do not cover the costs of repairing or replacing any part due to damage caused by poor or improper maintenance, contaminated fuels, or the use of fuels, oils, lubricants or fluids of a type other than those recommended in your Owners Manual.

Direct Connection warranties do not cover the costs of damage caused by environmental factors or Acts of God. "Environmental factors" include such items as airborne fallout, chemicals, tree sap, salt, ocean spray and road hazards. "Acts of God" include such things as hail, floods, windstorms, lightning, tornadoes, sandstorms and earthquakes.

Direct Connection warranties do not apply to parts installed on a vehicle that has had its odometer or emissions systems tampered with or disconnected, or that has been declared a total loss by any insurance company, or is rebuilt after being declared a total loss; or is issued a certificate of title indicating that it is designated as "salvage," "junk," "rebuilt" or words of similar import. FCA US LLC will deny warranty coverage without notice if it finds that a vehicle is ineligible for warranty coverage because it has been salvaged or declared a total loss as set forth in this paragraph.

Direct Connection Limited Warranties do not cover any incidental or consequential damages connected with the failure of the part under warranty. Such damages include lost time; inconvenience; the loss of the use of your vehicle; the cost of rental cars, gasoline, telephone, travel or lodging; the loss of personal or commercial property; or the loss of revenue. Some states do not allow the exclusion or limitation of incidental or consequential damages, so the above limitations or exclusions may not apply to you.

Your warranties can also be restricted by FCA US LLC, as set forth in the New Vehicle Limited Warranty. If your New Vehicle Limited Warranty is restricted by FCA US LLC, coverage under your Direct Connection Parts Limited Warranties may also be restricted or denied.

### OTHER TERMS:

To the extent allowed by law, any implied warranties, including any implied warranty of merchantability or fitness for a particular purpose, are limited in duration to the duration of these express warranties. Some states do not allow limitations on how long an implied warranty lasts, so the above limitations may not apply to you. These warranties are the only express warranties made by FCA US LLC for Direct Connection Parts. Except where prohibited by law, this warranty is the sole and exclusive remedy. No person, including a dealer or employee of FCA US LLC, has the authority to vary or change these warranties. Michigan law governs this warranty to the extent allowed by law. Interpretation of the terms of this warranty must be done using Michigan law. These limited warranties give you specific legal rights and you may also have other rights which vary from state to state.





# 1 3 5 R DODGE GARAGE 2 4 6

Visit DodgeGarage.com for all of your Direct Connection Performance news and events!

# MADE YOU LOOK

#DodgeMoparMotorsports

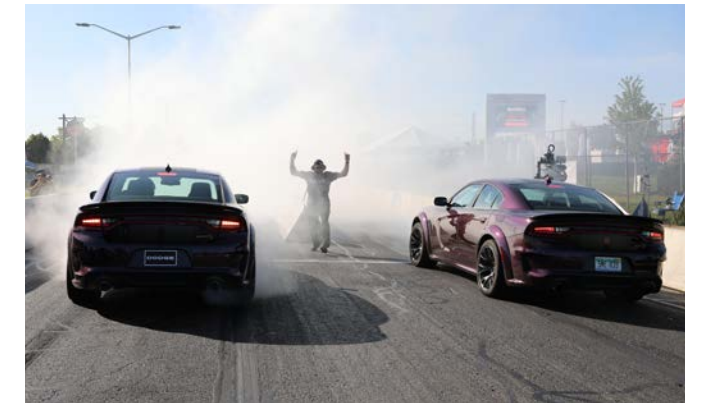

Follow for exclusive, behind-the-scenes updates and action from a track or event near you.



@dodgemoparmotorsports

# DODGE GARAGE.COM



