

INSTALLATION DEVICES

CATALOGUE
OF INSTALLATION
DEVICES AND ACCESSORIES

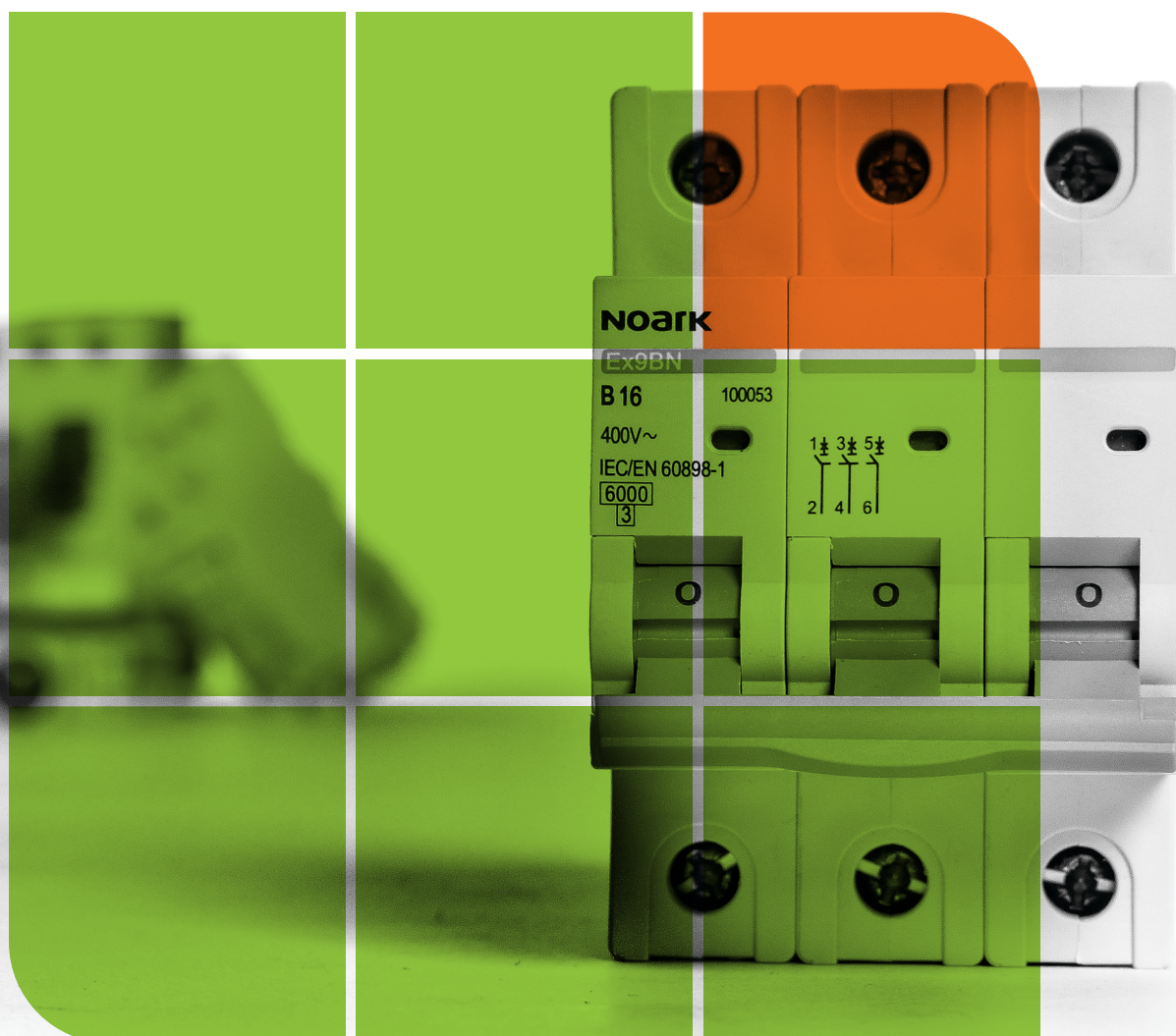

VALID FROM 1ST APRIL 2022



www.noark-electric.eu

NOARK

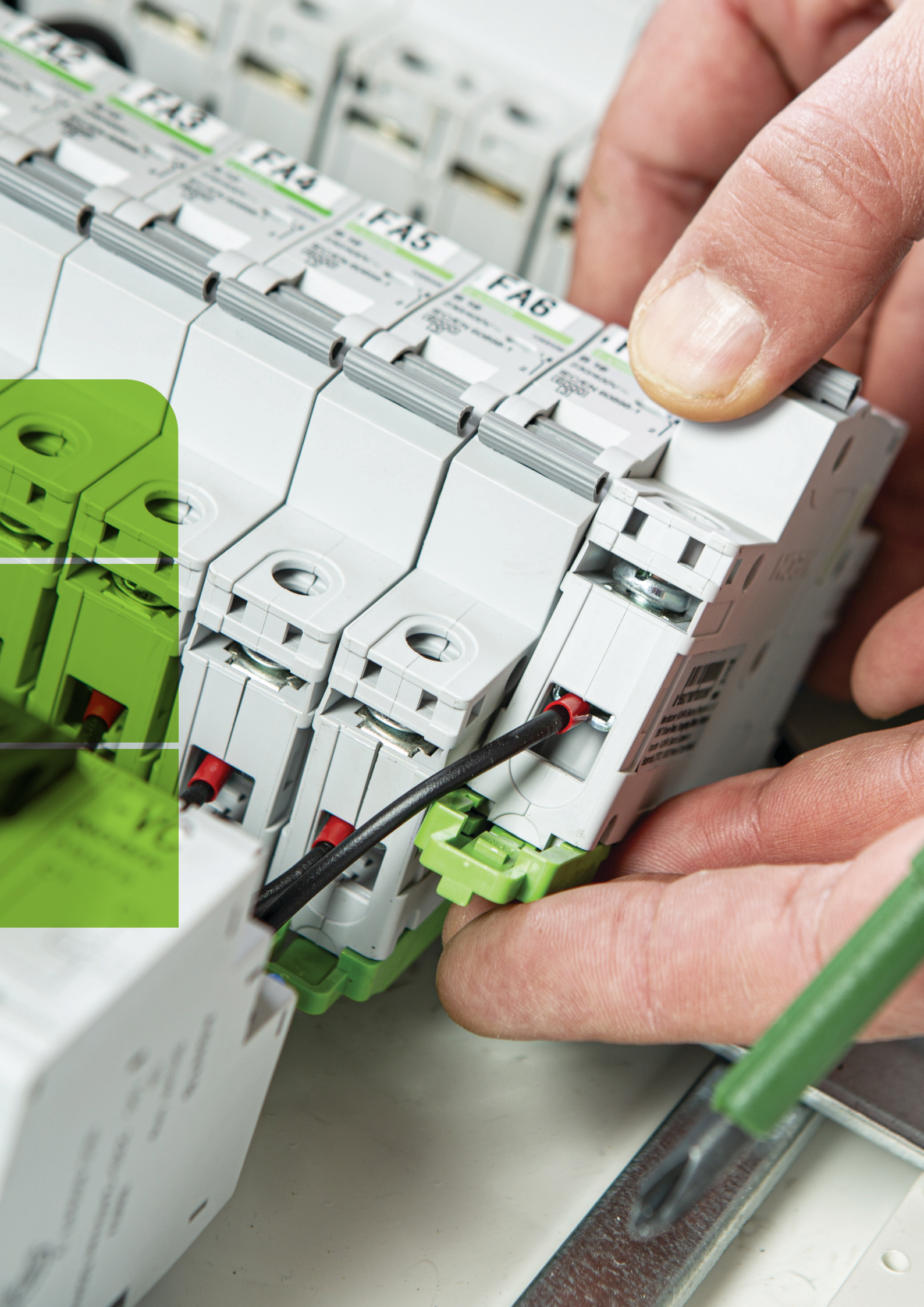

Content

Ordering Information

Miniature Circuit Breakers

Ex9BH MCBs up to 63 A, 10 kA	7
Ex9BN MCBs up to 63 A, 6 kA	15
Ex9B40J MCBs up to 40 A	23
Ex9B125 MCBs up to 100 A	27
Ex9PN 1P+N single-module unit MCBs, 6 kA	35
Ex9BP-JX DC MCBs up to 63 A	39

Fuse holders and disconnectors

Ex9F fuse holders	47
Ex9FP DC fuse disconnectors	49
Ex9FS fuse switch disconnectors	51

Isolators

Ex9I125 isolators up to 125 A	55
Ex9I40 single-module unit isolators up to 40 A	57
Ex9BI isolators up to 63 A with accessories	59

Residual Current Devices

Ex9L-H RCCBs up to 63 A, 10 kA	65
Ex9L-N RCCBs up to 63 A, 6 kA	73
Ex9CL-100 RCCBs up to 100 A, 10 kA	81
Ex9LB63 B type RCCBs up to 63 A, 10 kA	85
Ex9BL-H RCBOs up to 40 A, 10 kA	87
Ex9BL-N RCBOs up to 40 A, 6 kA	93
Ex9NLE RCBOs up to 40 A, 6 kA	99
Ex9NL-N RCBO up to 40 A, 6 kA	103
Ex9LE RCD add-on blocks.....	107

Energy meters

Ex9EM energy meters	115
Ex9EMS smart energy meters	117
CT current transformers	120

Motor Protective Circuit Breakers

Ex9SN25B motor protective circuit breakers to 25 A	125
--	-----

Accessories for Installation Devices

Accessories for devices of Ex9B, Ex9PN line	131
Accessories for devices of Ex9SN25B line	135
Accessories for devices of Ex9NLE, Ex9NL-N line	139

Surge Protection Devices

Ex9UE1+2 SPDs Type 1+2, 25 kA	143
Ex9UE1+2 SPDs Type 1+2, 12,5 kA	145
Ex9UE2 SPDs Type 2	147
Ex9UE3 SPDs Type 3	149

Installation relays and contactors

Ex9CH20 installation relays	153
Ex9CH installation contactors	155
Ex9CHM installation contactors with manual operation	159
Ex9JU impulse relays	166

Content

Ordering Information

Switches signals and lamps	
Ex9BT change-over switches	171
Ex9PD signal lamps	173
Ex9PDe signal lamps	177
Timers and light intensity switches	
Ex9TAM2 analogue timers	181
Ex9TDM miniature digital timers	183
Ex9DTS digital timers	185
Ex9SS staircase switches	187
Ex9LAS analogue light intensity switches	189
Ex9LDS digital light intensity switches	189
Ex9TR time relays.....	191
Other installation devices	
Ex9HB din rail bell.....	197
Ex9PS power supplies.....	199
Technical data	201
Index	362
Catalogues and assortment overview	364

Content

Technical Data

Miniature Circuit Breakers

Ex9BH MCBs up to 63 A, 10 kA	204
Ex9BN MCBs up to 63 A, 6 kA	208
Ex9B40J MCBs up to 40 A	212
Ex9B125 MCBs up to 100 A	214
Ex9PN 1P+N single-module unit MCBs, 6 kA	218
Ex9BP-JX DC MCBs up to 63 A	221

Fuse holders and disconnectors

Ex9F fuse holders	224
Ex9FP DC fuse disconnectors	226
Ex9FS fuse switch disconnectors	228

Isolators

Ex9I125 isolators up to 125 A	230
Ex9I40 single-module unit isolators up to 40 A	232
Ex9BI isolators up to 63 A with accessories	234

Residual Current Devices

Ex9L-H RCCBs up to 63 A, 10 kA	236
Ex9L-N RCCBs up to 63 A, 6 kA	239
Ex9CL-100 RCCBs up to 100 A, 10 kA	242
Ex9LB63 B type RCCBs up to 63 A, 10 kA	246
Ex9BL-H RCBOs up to 40 A, 10 kA	249
Ex9BL-N RCBOs up to 40 A, 6 kA	252
Ex9NLE RCBOs up to 40 A, 6 kA	255
Ex9NL-N RCBO up to 40 A, 6 kA	258
Ex9LE RCD add-on blocks.....	261

Energy meters

Ex9EM energy meters	263
Ex9EMS smart energy meters	266
CT current transformers	271

Motor Protective Circuit Breakers

Ex9SN25B motor protective circuit breakers to 25 A	274
--	-----

Accessories for Installation Devices

Accessories for devices of Ex9B, Ex9PN line	278
Accessories for devices of Ex9SN25B line	286
Accessories for devices of Ex9NLE, Ex9NL-N line	292

Surge Protection Devices

Ex9UE1+2 SPDs Type 1+2, 25 kA	298
Ex9UE1+2 SPDs Type 1+2, 12,5 kA	301
Ex9UE2 SPDs Type 2	307
Ex9UE3 SPDs Type 3	310

Installation relays and contactors

Ex9CH20 installation relays	312
Ex9CH installation contactors	314
Ex9CHM installation contactors with manual operation	316
Ex9JU impulse relays	319

Content

Technical Data

Switches and signal lamps

Ex9BT change-over switches	321
Ex9PD signal lamps	323
Ex9PDe signal lamps	325

Timers and light intensity switches

Ex9TAM2 analogue timers	327
Ex9TDM miniature digital timers	329
Ex9DTS digital timers	331
Ex9SS staircase switches	334
Ex9LAS analogue light intensity switches	337
Ex9LDS digital light intensity switches	340
Ex9TR time relays	343

Other installation devices

Ex9HB din rail bell.....	355
Ex9PS power supplies.....	357

Miniature Circuit Breakers



Miniature Circuit Breakers

Professional Tips

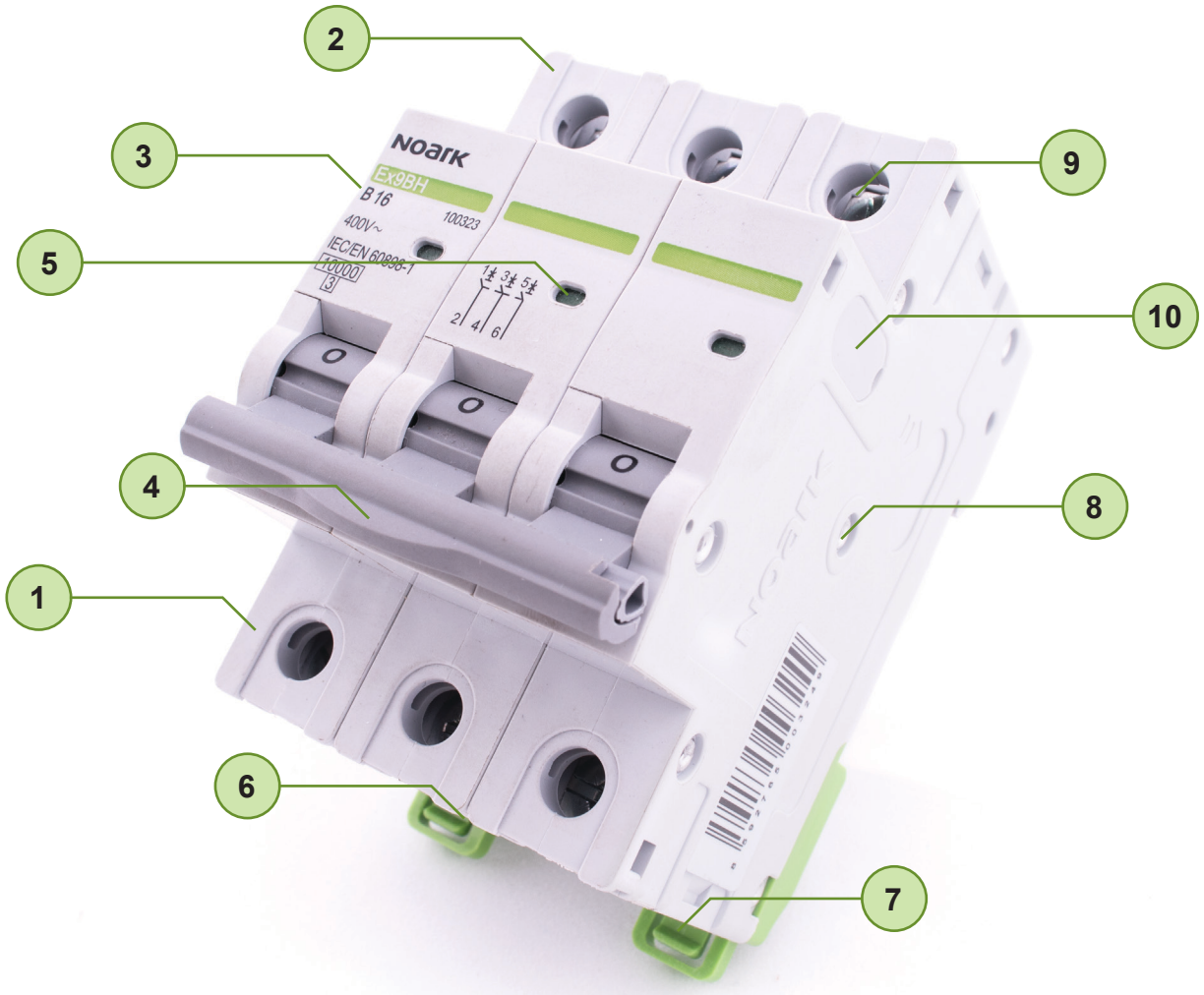

- | | |
|---|---|
| <ul style="list-style-type: none"> 1 5 year warranty 2 Rated current from 1 A up to 100 A 3 Tripping characteristics B, C, D 4 Colored toggle in Ex9BH and Ex9B125 line 5 Contacts state indication window | <ul style="list-style-type: none"> 6 Possibility to use interconnection busbars 7 Easy mounting on DIN rail 8 Undemountable and robust construction 9 Reversible line and load connection 10 Wide range of accessories |
|---|---|

Miniature Circuit Breakers Ex9BH, 10 kA



- Miniature Circuit Breakers according to IEC/EN 60898-1 and IEC/EN 60947-2 (partially)
- Rated short circuit breaking capacity 10 kA
- 1 up to 4-pole versions
- Tripping characteristics B, C, D
- Rated current up to 63 A
- Rated operational voltage 240/415 V AC
- 72 V DC per pole (1P, 2P)
48 V DC per pole (3P, 4P)
- Wide range of accessories
- Toggle colour according to rated current

Ex9BH miniature circuit breakers are suitable for domestic as well as industrial applications. They can be combined with wide range of accessories including auxiliary and signal contacts, shunt trip release, undervoltage and overvoltage release or RCD add-on block. It is possible to create diversified combination of accessories. These combinations are only limited by total number, not by the type of accessories - all components fit together. It can be used up to three units of auxiliary or alarm contacts plus up to two units for release units.

Type Key

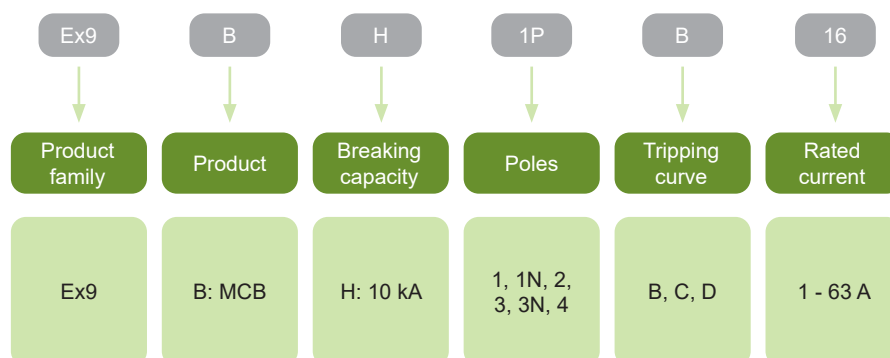

Certification marks



Miniature Circuit Breakers Ex9BH, 10 kA

Accessories



Auxiliary or signal contacts
AX, AL, AXL
Up to 3 units

Voltage or trip releases
SHT, UVT, OVT
Up to 2 units

MCB
Ex9B
1, 1+N, 2, 3, 3+N, 4-pole

RCD add-on block
Ex9LE
1+N, 2, 3, 3+N, 4-pole

Auxiliary contacts AX3111, AX3122	see page 132
Alarm contact AL3111	see page 132
Auxiliary and alarm contact AXL31	see page 132
Shunt trip releases SHT31, SHT3111	see page 132
Undervoltage releases UVT31, UVT3101, UVT3110	see page 133
Overvoltage release OVT31	see page 133
RCD add-on blocks Ex9LE	see page 109

RCD add-on blocks are mounted to the MCBs Ex9B from the right, the other accessories from the left and are identical for devices of the line Ex9B, Ex9PN and Ex9IP.

Miniature Circuit Breakers Ex9BH, 10 kA

B-Characteristic, 1-pole



Rated current	Poles	Char.	Article No.	Type	Packing
1 A	1	B	100270	Ex9BH 1P B1	1/12/144
2 A	1	B	100271	Ex9BH 1P B2	1/12/144
3 A	1	B	100272	Ex9BH 1P B3	1/12/144
4 A	1	B	100273	Ex9BH 1P B4	1/12/144
6 A	1	B	100274	Ex9BH 1P B6	1/12/144
8 A	1	B	100275	Ex9BH 1P B8	1/12/144
10 A	1	B	100276	Ex9BH 1P B10	1/12/144
13 A	1	B	100277	Ex9BH 1P B13	1/12/144
16 A	1	B	100278	Ex9BH 1P B16	1/12/144
20 A	1	B	100279	Ex9BH 1P B20	1/12/144
25 A	1	B	100280	Ex9BH 1P B25	1/12/144
32 A	1	B	100281	Ex9BH 1P B32	1/12/144
40 A	1	B	100282	Ex9BH 1P B40	1/12/144
50 A	1	B	100283	Ex9BH 1P B50	1/12/144
63 A	1	B	100284	Ex9BH 1P B63	1/12/144

B-Characteristic, 1+N-pole



Rated current	Poles	Char.	Article No.	Type	Packing
1 A	1+N	B	100285	Ex9BH 1PN B1	1/6/72
2 A	1+N	B	100286	Ex9BH 1PN B2	1/6/72
3 A	1+N	B	100287	Ex9BH 1PN B3	1/6/72
4 A	1+N	B	100288	Ex9BH 1PN B4	1/6/72
6 A	1+N	B	100289	Ex9BH 1PN B6	1/6/72
8 A	1+N	B	100290	Ex9BH 1PN B8	1/6/72
10 A	1+N	B	100291	Ex9BH 1PN B10	1/6/72
13 A	1+N	B	100292	Ex9BH 1PN B13	1/6/72
16 A	1+N	B	100293	Ex9BH 1PN B16	1/6/72
20 A	1+N	B	100294	Ex9BH 1PN B20	1/6/72
25 A	1+N	B	100295	Ex9BH 1PN B25	1/6/72
32 A	1+N	B	100296	Ex9BH 1PN B32	1/6/72
40 A	1+N	B	100297	Ex9BH 1PN B40	1/6/72
50 A	1+N	B	100298	Ex9BH 1PN B50	1/6/72
63 A	1+N	B	100299	Ex9BH 1PN B63	1/6/72

B-Characteristic, 2-pole



Rated current	Poles	Char.	Article No.	Type	Packing
1 A	2	B	100300	Ex9BH 2P B1	1/6/72
2 A	2	B	100301	Ex9BH 2P B2	1/6/72
3 A	2	B	100302	Ex9BH 2P B3	1/6/72
4 A	2	B	100303	Ex9BH 2P B4	1/6/72
6 A	2	B	100304	Ex9BH 2P B6	1/6/72
8 A	2	B	100305	Ex9BH 2P B8	1/6/72
10 A	2	B	100306	Ex9BH 2P B10	1/6/72
13 A	2	B	100307	Ex9BH 2P B13	1/6/72
16 A	2	B	100308	Ex9BH 2P B16	1/6/72
20 A	2	B	100309	Ex9BH 2P B20	1/6/72
25 A	2	B	100310	Ex9BH 2P B25	1/6/72
32 A	2	B	100311	Ex9BH 2P B32	1/6/72
40 A	2	B	100312	Ex9BH 2P B40	1/6/72
50 A	2	B	100313	Ex9BH 2P B50	1/6/72
63 A	2	B	100314	Ex9BH 2P B63	1/6/72

Miniature Circuit Breakers Ex9BH, 10 kA

B-Characteristic, 3-pole



Rated current	Poles	Char.	Article No.	Type	Packing
1 A	3	B	100315	Ex9BH 3P B1	1/4/48
2 A	3	B	100316	Ex9BH 3P B2	1/4/48
3 A	3	B	100317	Ex9BH 3P B3	1/4/48
4 A	3	B	100318	Ex9BH 3P B4	1/4/48
6 A	3	B	100319	Ex9BH 3P B6	1/4/48
8 A	3	B	100320	Ex9BH 3P B8	1/4/48
10 A	3	B	100321	Ex9BH 3P B10	1/4/48
13 A	3	B	100322	Ex9BH 3P B13	1/4/48
16 A	3	B	100323	Ex9BH 3P B16	1/4/48
20 A	3	B	100324	Ex9BH 3P B20	1/4/48
25 A	3	B	100325	Ex9BH 3P B25	1/4/48
32 A	3	B	100326	Ex9BH 3P B32	1/4/48
40 A	3	B	100327	Ex9BH 3P B40	1/4/48
50 A	3	B	100328	Ex9BH 3P B50	1/4/48
63 A	3	B	100329	Ex9BH 3P B63	1/4/48

B-Characteristic, 3+N-pole



Rated current	Poles	Char.	Article No.	Type	Packing
1 A	3+N	B	100330	Ex9BH 3PN B1	1/3/36
2 A	3+N	B	100331	Ex9BH 3PN B2	1/3/36
3 A	3+N	B	100332	Ex9BH 3PN B3	1/3/36
4 A	3+N	B	100333	Ex9BH 3PN B4	1/3/36
6 A	3+N	B	100334	Ex9BH 3PN B6	1/3/36
8 A	3+N	B	100335	Ex9BH 3PN B8	1/3/36
10 A	3+N	B	100336	Ex9BH 3PN B10	1/3/36
13 A	3+N	B	100337	Ex9BH 3PN B13	1/3/36
16 A	3+N	B	100338	Ex9BH 3PN B16	1/3/36
20 A	3+N	B	100339	Ex9BH 3PN B20	1/3/36
25 A	3+N	B	100340	Ex9BH 3PN B25	1/3/36
32 A	3+N	B	100341	Ex9BH 3PN B32	1/3/36
40 A	3+N	B	100342	Ex9BH 3PN B40	1/3/36
50 A	3+N	B	100343	Ex9BH 3PN B50	1/3/36
63 A	3+N	B	100344	Ex9BH 3PN B63	1/3/36

B-Characteristic, 4-pole



Rated current	Poles	Char.	Article No.	Type	Packing
1 A	4	B	100345	Ex9BH 4P B1	1/3/36
2 A	4	B	100346	Ex9BH 4P B2	1/3/36
3 A	4	B	100347	Ex9BH 4P B3	1/3/36
4 A	4	B	100348	Ex9BH 4P B4	1/3/36
6 A	4	B	100349	Ex9BH 4P B6	1/3/36
8 A	4	B	100350	Ex9BH 4P B8	1/3/36
10 A	4	B	100351	Ex9BH 4P B10	1/3/36
13 A	4	B	100352	Ex9BH 4P B13	1/3/36
16 A	4	B	100353	Ex9BH 4P B16	1/3/36
20 A	4	B	100354	Ex9BH 4P B20	1/3/36
25 A	4	B	100355	Ex9BH 4P B25	1/3/36
32 A	4	B	100356	Ex9BH 4P B32	1/3/36
40 A	4	B	100357	Ex9BH 4P B40	1/3/36
50 A	4	B	100358	Ex9BH 4P B50	1/3/36
63 A	4	B	100359	Ex9BH 4P B63	1/3/36

Miniature Circuit Breakers Ex9BH, 10 kA

C-Characteristic, 1-pole



Rated current	Poles	Char.	Article No.	Type	Packing
1 A	1	C	100360	Ex9BH 1P C1	1/12/144
2 A	1	C	100361	Ex9BH 1P C2	1/12/144
3 A	1	C	100362	Ex9BH 1P C3	1/12/144
4 A	1	C	100363	Ex9BH 1P C4	1/12/144
6 A	1	C	100364	Ex9BH 1P C6	1/12/144
8 A	1	C	100365	Ex9BH 1P C8	1/12/144
10 A	1	C	100366	Ex9BH 1P C10	1/12/144
13 A	1	C	100367	Ex9BH 1P C13	1/12/144
16 A	1	C	100368	Ex9BH 1P C16	1/12/144
20 A	1	C	100369	Ex9BH 1P C20	1/12/144
25 A	1	C	100370	Ex9BH 1P C25	1/12/144
32 A	1	C	100371	Ex9BH 1P C32	1/12/144
40 A	1	C	100372	Ex9BH 1P C40	1/12/144
50 A	1	C	100373	Ex9BH 1P C50	1/12/144
63 A	1	C	100374	Ex9BH 1P C63	1/12/144

C-Characteristic, 1+N-pole



Rated current	Poles	Char.	Article No.	Type	Packing
1 A	1+N	C	100375	Ex9BH 1PN C1	1/6/72
2 A	1+N	C	100376	Ex9BH 1PN C2	1/6/72
3 A	1+N	C	100377	Ex9BH 1PN C3	1/6/72
4 A	1+N	C	100378	Ex9BH 1PN C4	1/6/72
6 A	1+N	C	100379	Ex9BH 1PN C6	1/6/72
8 A	1+N	C	100380	Ex9BH 1PN C8	1/6/72
10 A	1+N	C	100381	Ex9BH 1PN C10	1/6/72
13 A	1+N	C	100382	Ex9BH 1PN C13	1/6/72
16 A	1+N	C	100383	Ex9BH 1PN C16	1/6/72
20 A	1+N	C	100384	Ex9BH 1PN C20	1/6/72
25 A	1+N	C	100385	Ex9BH 1PN C25	1/6/72
32 A	1+N	C	100386	Ex9BH 1PN C32	1/6/72
40 A	1+N	C	100387	Ex9BH 1PN C40	1/6/72
50 A	1+N	C	100388	Ex9BH 1PN C50	1/6/72
63 A	1+N	C	100389	Ex9BH 1PN C63	1/6/72

C-Characteristic, 2-pole



Rated current	Poles	Char.	Article No.	Type	Packing
1 A	2	C	100390	Ex9BH 2P C1	1/6/72
2 A	2	C	100391	Ex9BH 2P C2	1/6/72
3 A	2	C	100392	Ex9BH 2P C3	1/6/72
4 A	2	C	100393	Ex9BH 2P C4	1/6/72
6 A	2	C	100394	Ex9BH 2P C6	1/6/72
8 A	2	C	100395	Ex9BH 2P C8	1/6/72
10 A	2	C	100396	Ex9BH 2P C10	1/6/72
13 A	2	C	100397	Ex9BH 2P C13	1/6/72
16 A	2	C	100398	Ex9BH 2P C16	1/6/72
20 A	2	C	100399	Ex9BH 2P C20	1/6/72
25 A	2	C	100400	Ex9BH 2P C25	1/6/72
32 A	2	C	100401	Ex9BH 2P C32	1/6/72
40 A	2	C	100402	Ex9BH 2P C40	1/6/72
50 A	2	C	100403	Ex9BH 2P C50	1/6/72
63 A	2	C	100404	Ex9BH 2P C63	1/6/72

Miniature Circuit Breakers Ex9BH, 10 kA

C-Characteristic, 3-pole



Rated current	Poles	Char.	Article No.	Type	Packing
1 A	3	C	100405	Ex9BH 3P C1	1/4/48
2 A	3	C	100406	Ex9BH 3P C2	1/4/48
3 A	3	C	100407	Ex9BH 3P C3	1/4/48
4 A	3	C	100408	Ex9BH 3P C4	1/4/48
6 A	3	C	100409	Ex9BH 3P C6	1/4/48
8 A	3	C	100410	Ex9BH 3P C8	1/4/48
10 A	3	C	100411	Ex9BH 3P C10	1/4/48
13 A	3	C	100412	Ex9BH 3P C13	1/4/48
16 A	3	C	100413	Ex9BH 3P C16	1/4/48
20 A	3	C	100414	Ex9BH 3P C20	1/4/48
25 A	3	C	100415	Ex9BH 3P C25	1/4/48
32 A	3	C	100416	Ex9BH 3P C32	1/4/48
40 A	3	C	100417	Ex9BH 3P C40	1/4/48
50 A	3	C	100418	Ex9BH 3P C50	1/4/48
63 A	3	C	100419	Ex9BH 3P C63	1/4/48

C-Characteristic, 3+N-pole



Rated current	Poles	Char.	Article No.	Type	Packing
1 A	3+N	C	100420	Ex9BH 3PN C1	1/3/36
2 A	3+N	C	100421	Ex9BH 3PN C2	1/3/36
3 A	3+N	C	100422	Ex9BH 3PN C3	1/3/36
4 A	3+N	C	100423	Ex9BH 3PN C4	1/3/36
6 A	3+N	C	100424	Ex9BH 3PN C6	1/3/36
8 A	3+N	C	100425	Ex9BH 3PN C8	1/3/36
10 A	3+N	C	100426	Ex9BH 3PN C10	1/3/36
13 A	3+N	C	100427	Ex9BH 3PN C13	1/3/36
16 A	3+N	C	100428	Ex9BH 3PN C16	1/3/36
20 A	3+N	C	100429	Ex9BH 3PN C20	1/3/36
25 A	3+N	C	100430	Ex9BH 3PN C25	1/3/36
32 A	3+N	C	100431	Ex9BH 3PN C32	1/3/36
40 A	3+N	C	100432	Ex9BH 3PN C40	1/3/36
50 A	3+N	C	100433	Ex9BH 3PN C50	1/3/36
63 A	3+N	C	100434	Ex9BH 3PN C63	1/3/36

C-Characteristic, 4-pole



Rated current	Poles	Char.	Article No.	Type	Packing
1 A	4	C	100435	Ex9BH 4P C1	1/3/36
2 A	4	C	100436	Ex9BH 4P C2	1/3/36
3 A	4	C	100437	Ex9BH 4P C3	1/3/36
4 A	4	C	100438	Ex9BH 4P C4	1/3/36
6 A	4	C	100439	Ex9BH 4P C6	1/3/36
8 A	4	C	100440	Ex9BH 4P C8	1/3/36
10 A	4	C	100441	Ex9BH 4P C10	1/3/36
13 A	4	C	100442	Ex9BH 4P C13	1/3/36
16 A	4	C	100443	Ex9BH 4P C16	1/3/36
20 A	4	C	100444	Ex9BH 4P C20	1/3/36
25 A	4	C	100445	Ex9BH 4P C25	1/3/36
32 A	4	C	100446	Ex9BH 4P C32	1/3/36
40 A	4	C	100447	Ex9BH 4P C40	1/3/36
50 A	4	C	100448	Ex9BH 4P C50	1/3/36
63 A	4	C	100449	Ex9BH 4P C63	1/3/36

Miniature Circuit Breakers Ex9BH, 10 kA

D-Characteristic, 1-pole



Rated current	Poles	Char.	Article No.	Type	Packing
1 A	1	D	100450	Ex9BH 1P D1	1/12/144
2 A	1	D	100451	Ex9BH 1P D2	1/12/144
3 A	1	D	100452	Ex9BH 1P D3	1/12/144
4 A	1	D	100453	Ex9BH 1P D4	1/12/144
6 A	1	D	100454	Ex9BH 1P D6	1/12/144
8 A	1	D	100455	Ex9BH 1P D8	1/12/144
10 A	1	D	100456	Ex9BH 1P D10	1/12/144
13 A	1	D	100457	Ex9BH 1P D13	1/12/144
16 A	1	D	100458	Ex9BH 1P D16	1/12/144
20 A	1	D	100459	Ex9BH 1P D20	1/12/144
25 A	1	D	100460	Ex9BH 1P D25	1/12/144
32 A	1	D	100461	Ex9BH 1P D32	1/12/144
40 A	1	D	100462	Ex9BH 1P D40	1/12/144
50 A	1	D	100463	Ex9BH 1P D50	1/12/144
63 A	1	D	100464	Ex9BH 1P D63	1/12/144

D-Characteristic, 1+N-pole



Rated current	Poles	Char.	Article No.	Type	Packing
1 A	1+N	D	100465	Ex9BH 1PN D1	1/6/72
2 A	1+N	D	100466	Ex9BH 1PN D2	1/6/72
3 A	1+N	D	100467	Ex9BH 1PN D3	1/6/72
4 A	1+N	D	100468	Ex9BH 1PN D4	1/6/72
6 A	1+N	D	100469	Ex9BH 1PN D6	1/6/72
8 A	1+N	D	100470	Ex9BH 1PN D8	1/6/72
10 A	1+N	D	100471	Ex9BH 1PN D10	1/6/72
13 A	1+N	D	100472	Ex9BH 1PN D13	1/6/72
16 A	1+N	D	100473	Ex9BH 1PN D16	1/6/72
20 A	1+N	D	100474	Ex9BH 1PN D20	1/6/72
25 A	1+N	D	100475	Ex9BH 1PN D25	1/6/72
32 A	1+N	D	100476	Ex9BH 1PN D32	1/6/72
40 A	1+N	D	100477	Ex9BH 1PN D40	1/6/72
50 A	1+N	D	100478	Ex9BH 1PN D50	1/6/72
63 A	1+N	D	100479	Ex9BH 1PN D63	1/6/72

D-Characteristic, 2-pole



Rated current	Poles	Char.	Article No.	Type	Packing
1 A	2	D	100480	Ex9BH 2P D1	1/6/72
2 A	2	D	100481	Ex9BH 2P D2	1/6/72
3 A	2	D	100482	Ex9BH 2P D3	1/6/72
4 A	2	D	100483	Ex9BH 2P D4	1/6/72
6 A	2	D	100484	Ex9BH 2P D6	1/6/72
8 A	2	D	100485	Ex9BH 2P D8	1/6/72
10 A	2	D	100486	Ex9BH 2P D10	1/6/72
13 A	2	D	100487	Ex9BH 2P D13	1/6/72
16 A	2	D	100488	Ex9BH 2P D16	1/6/72
20 A	2	D	100489	Ex9BH 2P D20	1/6/72
25 A	2	D	100490	Ex9BH 2P D25	1/6/72
32 A	2	D	100491	Ex9BH 2P D32	1/6/72
40 A	2	D	100492	Ex9BH 2P D40	1/6/72
50 A	2	D	100493	Ex9BH 2P D50	1/6/72
63 A	2	D	100494	Ex9BH 2P D63	1/6/72

Miniature Circuit Breakers Ex9BH, 10 kA

D-Characteristic, 3-pole



Rated current	Poles	Char.	Article No.	Type	Packing
1 A	3	D	100495	Ex9BH 3P D1	1/4/48
2 A	3	D	100496	Ex9BH 3P D2	1/4/48
3 A	3	D	100497	Ex9BH 3P D3	1/4/48
4 A	3	D	100498	Ex9BH 3P D4	1/4/48
6 A	3	D	100499	Ex9BH 3P D6	1/4/48
8 A	3	D	100500	Ex9BH 3P D8	1/4/48
10 A	3	D	100501	Ex9BH 3P D10	1/4/48
13 A	3	D	100502	Ex9BH 3P D13	1/4/48
16 A	3	D	100503	Ex9BH 3P D16	1/4/48
20 A	3	D	100504	Ex9BH 3P D20	1/4/48
25 A	3	D	100505	Ex9BH 3P D25	1/4/48
32 A	3	D	100506	Ex9BH 3P D32	1/4/48
40 A	3	D	100507	Ex9BH 3P D40	1/4/48
50 A	3	D	100508	Ex9BH 3P D50	1/4/48
63 A	3	D	100509	Ex9BH 3P D63	1/4/48

D-Characteristic, 3+N-pole



Rated current	Poles	Char.	Article No.	Type	Packing
1 A	3+N	D	100510	Ex9BH 3PN D1	1/3/36
2 A	3+N	D	100511	Ex9BH 3PN D2	1/3/36
3 A	3+N	D	100512	Ex9BH 3PN D3	1/3/36
4 A	3+N	D	100513	Ex9BH 3PN D4	1/3/36
6 A	3+N	D	100514	Ex9BH 3PN D6	1/3/36
8 A	3+N	D	100515	Ex9BH 3PN D8	1/3/36
10 A	3+N	D	100516	Ex9BH 3PN D10	1/3/36
13 A	3+N	D	100517	Ex9BH 3PN D13	1/3/36
16 A	3+N	D	100518	Ex9BH 3PN D16	1/3/36
20 A	3+N	D	100519	Ex9BH 3PN D20	1/3/36
25 A	3+N	D	100520	Ex9BH 3PN D25	1/3/36
32 A	3+N	D	100521	Ex9BH 3PN D32	1/3/36
40 A	3+N	D	100522	Ex9BH 3PN D40	1/3/36
50 A	3+N	D	100523	Ex9BH 3PN D50	1/3/36
63 A	3+N	D	100524	Ex9BH 3PN D63	1/3/36

D-Characteristic, 4-pole



Rated current	Poles	Char.	Article No.	Type	Packing
1 A	4	D	100525	Ex9BH 4P D1	1/3/36
2 A	4	D	100526	Ex9BH 4P D2	1/3/36
3 A	4	D	100527	Ex9BH 4P D3	1/3/36
4 A	4	D	100528	Ex9BH 4P D4	1/3/36
6 A	4	D	100529	Ex9BH 4P D6	1/3/36
8 A	4	D	100530	Ex9BH 4P D8	1/3/36
10 A	4	D	100531	Ex9BH 4P D10	1/3/36
13 A	4	D	100532	Ex9BH 4P D13	1/3/36
16 A	4	D	100533	Ex9BH 4P D16	1/3/36
20 A	4	D	100534	Ex9BH 4P D20	1/3/36
25 A	4	D	100535	Ex9BH 4P D25	1/3/36
32 A	4	D	100536	Ex9BH 4P D32	1/3/36
40 A	4	D	100537	Ex9BH 4P D40	1/3/36
50 A	4	D	100538	Ex9BH 4P D50	1/3/36
63 A	4	D	100539	Ex9BH 4P D63	1/3/36

Miniature Circuit Breakers Ex9BN, 6 kA



- Miniature Circuit Breakers according to IEC/EN 60898-1 and IEC/EN 60947-2 (partially)
- Rated short circuit breaking capacity 6 kA
- 1 up to 4-pole versions
- Tripping characteristics B, C, D
- Rated current up to 63 A
- Rated operational voltage 240/415 V AC
- 72 V DC per pole (1P, 2P)
48 V DC per pole (3P, 4P)
- Wide range of accessories

Ex9BN miniature circuit breakers are suitable for domestic as well as industrial applications. They can be combined with wide range of accessories including auxiliary and signal contacts, shunt trip release, undervoltage and overvoltage release or RCD add-on block. It is possible to create diversified combination of accessories. These combinations are only limited by total number, not by the type of accessories - all components fit together. It can be used up to three units of auxiliary or alarm contacts plus up to two units for release units.

Type Key

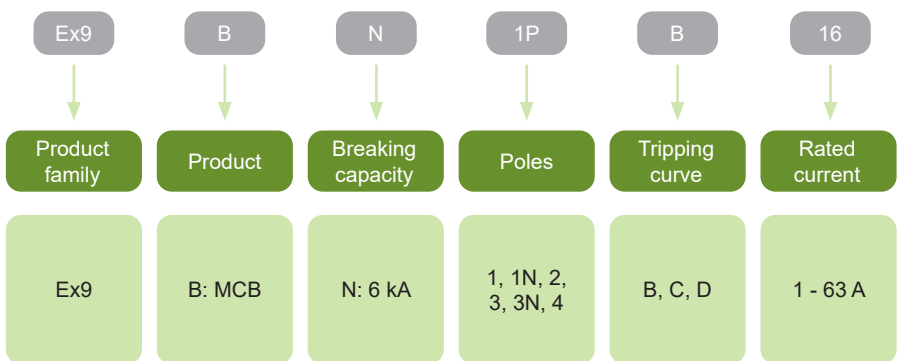

Certification marks



Miniature Circuit Breakers Ex9BN, 6 kA

Accessories



Auxiliary or signal contacts
AX, AL, AXL
Up to 3 units

Voltage or trip releases
SHT, UVT, OVT
Up to 2 units

MCB
Ex9B
1, 1+N, 2, 3, 3+N, 4-pole

RCD add-on block
Ex9LE
1+N, 2, 3, 3+N, 4-pole

Auxiliary contacts AX3111, AX3122

see page 132

Alarm contact AL3111

see page 132

Auxiliary and alarm contact AXL31

see page 132

Shunt trip releases SHT31, SHT3111

see page 132

Undervoltage releases UVT31, UVT3101, UVT3110

see page 133

Oversvoltage release OVT31

see page 133

RCD add-on blocks Ex9LE

see page 109

RCD add-on blocks are mounted to the MCBs Ex9B from the right, the other accessories from the left and are identical for devices of the line Ex9B, Ex9PN and Ex9IP.

Miniature Circuit Breakers Ex9BN, 6 kA

B-Characteristic, 1-pole



Rated current	Poles	Char.	Article No.	Type	Packing
1 A	1	B	100000	Ex9BN 1P B1	1/12/144
2 A	1	B	100001	Ex9BN 1P B2	1/12/144
3 A	1	B	100002	Ex9BN 1P B3	1/12/144
4 A	1	B	100003	Ex9BN 1P B4	1/12/144
6 A	1	B	100004	Ex9BN 1P B6	1/12/144
8 A	1	B	100005	Ex9BN 1P B8	1/12/144
10 A	1	B	100006	Ex9BN 1P B10	1/12/144
13 A	1	B	100007	Ex9BN 1P B13	1/12/144
16 A	1	B	100008	Ex9BN 1P B16	1/12/144
20 A	1	B	100009	Ex9BN 1P B20	1/12/144
25 A	1	B	100010	Ex9BN 1P B25	1/12/144
32 A	1	B	100011	Ex9BN 1P B32	1/12/144
40 A	1	B	100012	Ex9BN 1P B40	1/12/144
50 A	1	B	100013	Ex9BN 1P B50	1/12/144
63 A	1	B	100014	Ex9BN 1P B63	1/12/144

B-Characteristic, 1+N-pole



Rated current	Poles	Char.	Article No.	Type	Packing
1 A	1+N	B	100015	Ex9BN 1PN B1	1/6/72
2 A	1+N	B	100016	Ex9BN 1PN B2	1/6/72
3 A	1+N	B	100017	Ex9BN 1PN B3	1/6/72
4 A	1+N	B	100018	Ex9BN 1PN B4	1/6/72
6 A	1+N	B	100019	Ex9BN 1PN B6	1/6/72
8 A	1+N	B	100020	Ex9BN 1PN B8	1/6/72
10 A	1+N	B	100021	Ex9BN 1PN B10	1/6/72
13 A	1+N	B	100022	Ex9BN 1PN B13	1/6/72
16 A	1+N	B	100023	Ex9BN 1PN B16	1/6/72
20 A	1+N	B	100024	Ex9BN 1PN B20	1/6/72
25 A	1+N	B	100025	Ex9BN 1PN B25	1/6/72
32 A	1+N	B	100026	Ex9BN 1PN B32	1/6/72
40 A	1+N	B	100027	Ex9BN 1PN B40	1/6/72
50 A	1+N	B	100028	Ex9BN 1PN B50	1/6/72
63 A	1+N	B	100029	Ex9BN 1PN B63	1/6/72

B-Characteristic, 2-pole



Rated current	Poles	Char.	Article No.	Type	Packing
1 A	2	B	100030	Ex9BN 2P B1	1/6/72
2 A	2	B	100031	Ex9BN 2P B2	1/6/72
3 A	2	B	100032	Ex9BN 2P B3	1/6/72
4 A	2	B	100033	Ex9BN 2P B4	1/6/72
6 A	2	B	100034	Ex9BN 2P B6	1/6/72
8 A	2	B	100035	Ex9BN 2P B8	1/6/72
10 A	2	B	100036	Ex9BN 2P B10	1/6/72
13 A	2	B	100037	Ex9BN 2P B13	1/6/72
16 A	2	B	100038	Ex9BN 2P B16	1/6/72
20 A	2	B	100039	Ex9BN 2P B20	1/6/72
25 A	2	B	100040	Ex9BN 2P B25	1/6/72
32 A	2	B	100041	Ex9BN 2P B32	1/6/72
40 A	2	B	100042	Ex9BN 2P B40	1/6/72
50 A	2	B	100043	Ex9BN 2P B50	1/6/72
63 A	2	B	100044	Ex9BN 2P B63	1/6/72

Miniature Circuit Breakers Ex9BN, 6 kA

B-Characteristic, 3-pole



Rated current	Poles	Char.	Article No.	Type	Packing
1 A	3	B	100045	Ex9BN 3P B1	1/4/48
2 A	3	B	100046	Ex9BN 3P B2	1/4/48
3 A	3	B	100047	Ex9BN 3P B3	1/4/48
4 A	3	B	100048	Ex9BN 3P B4	1/4/48
6 A	3	B	100049	Ex9BN 3P B6	1/4/48
8 A	3	B	100050	Ex9BN 3P B8	1/4/48
10 A	3	B	100051	Ex9BN 3P B10	1/4/48
13 A	3	B	100052	Ex9BN 3P B13	1/4/48
16 A	3	B	100053	Ex9BN 3P B16	1/4/48
20 A	3	B	100054	Ex9BN 3P B20	1/4/48
25 A	3	B	100055	Ex9BN 3P B25	1/4/48
32 A	3	B	100056	Ex9BN 3P B32	1/4/48
40 A	3	B	100057	Ex9BN 3P B40	1/4/48
50 A	3	B	100058	Ex9BN 3P B50	1/4/48
63 A	3	B	100059	Ex9BN 3P B63	1/4/48

B-Characteristic, 3+N-pole



Rated current	Poles	Char.	Article No.	Type	Packing
1 A	3+N	B	100060	Ex9BN 3PN B1	1/3/36
2 A	3+N	B	100061	Ex9BN 3PN B2	1/3/36
3 A	3+N	B	100062	Ex9BN 3PN B3	1/3/36
4 A	3+N	B	100063	Ex9BN 3PN B4	1/3/36
6 A	3+N	B	100064	Ex9BN 3PN B6	1/3/36
8 A	3+N	B	100065	Ex9BN 3PN B8	1/3/36
10 A	3+N	B	100066	Ex9BN 3PN B10	1/3/36
13 A	3+N	B	100067	Ex9BN 3PN B13	1/3/36
16 A	3+N	B	100068	Ex9BN 3PN B16	1/3/36
20 A	3+N	B	100069	Ex9BN 3PN B20	1/3/36
25 A	3+N	B	100070	Ex9BN 3PN B25	1/3/36
32 A	3+N	B	100071	Ex9BN 3PN B32	1/3/36
40 A	3+N	B	100072	Ex9BN 3PN B40	1/3/36
50 A	3+N	B	100073	Ex9BN 3PN B50	1/3/36
63 A	3+N	B	100074	Ex9BN 3PN B63	1/3/36

B-Characteristic, 4-pole



Rated current	Poles	Char.	Article No.	Type	Packing
1 A	4	B	100075	Ex9BN 4P B1	1/3/36
2 A	4	B	100076	Ex9BN 4P B2	1/3/36
3 A	4	B	100077	Ex9BN 4P B3	1/3/36
4 A	4	B	100078	Ex9BN 4P B4	1/3/36
6 A	4	B	100079	Ex9BN 4P B6	1/3/36
8 A	4	B	100080	Ex9BN 4P B8	1/3/36
10 A	4	B	100081	Ex9BN 4P B10	1/3/36
13 A	4	B	100082	Ex9BN 4P B13	1/3/36
16 A	4	B	100083	Ex9BN 4P B16	1/3/36
20 A	4	B	100084	Ex9BN 4P B20	1/3/36
25 A	4	B	100085	Ex9BN 4P B25	1/3/36
32 A	4	B	100086	Ex9BN 4P B32	1/3/36
40 A	4	B	100087	Ex9BN 4P B40	1/3/36
50 A	4	B	100088	Ex9BN 4P B50	1/3/36
63 A	4	B	100089	Ex9BN 4P B63	1/3/36

Miniature Circuit Breakers Ex9BN, 6 kA

C-Characteristic, 1-pole



Rated current	Poles	Char.	Article No.	Type	Packing
1 A	1	C	100090	Ex9BN 1P C1	1/12/144
2 A	1	C	100091	Ex9BN 1P C2	1/12/144
3 A	1	C	100092	Ex9BN 1P C3	1/12/144
4 A	1	C	100093	Ex9BN 1P C4	1/12/144
6 A	1	C	100094	Ex9BN 1P C6	1/12/144
8 A	1	C	100095	Ex9BN 1P C8	1/12/144
10 A	1	C	100096	Ex9BN 1P C10	1/12/144
13 A	1	C	100097	Ex9BN 1P C13	1/12/144
16 A	1	C	100098	Ex9BN 1P C16	1/12/144
20 A	1	C	100099	Ex9BN 1P C20	1/12/144
25 A	1	C	100100	Ex9BN 1P C25	1/12/144
32 A	1	C	100101	Ex9BN 1P C32	1/12/144
40 A	1	C	100102	Ex9BN 1P C40	1/12/144
50 A	1	C	100103	Ex9BN 1P C50	1/12/144
63 A	1	C	100104	Ex9BN 1P C63	1/12/144

C-Characteristic, 1+N-pole



Rated current	Poles	Char.	Article No.	Type	Packing
1 A	1+N	C	100105	Ex9BN 1PN C1	1/6/72
2 A	1+N	C	100106	Ex9BN 1PN C2	1/6/72
3 A	1+N	C	100107	Ex9BN 1PN C3	1/6/72
4 A	1+N	C	100108	Ex9BN 1PN C4	1/6/72
6 A	1+N	C	100109	Ex9BN 1PN C6	1/6/72
8 A	1+N	C	100110	Ex9BN 1PN C8	1/6/72
10 A	1+N	C	100111	Ex9BN 1PN C10	1/6/72
13 A	1+N	C	100112	Ex9BN 1PN C13	1/6/72
16 A	1+N	C	100113	Ex9BN 1PN C16	1/6/72
20 A	1+N	C	100114	Ex9BN 1PN C20	1/6/72
25 A	1+N	C	100115	Ex9BN 1PN C25	1/6/72
32 A	1+N	C	100116	Ex9BN 1PN C32	1/6/72
40 A	1+N	C	100117	Ex9BN 1PN C40	1/6/72
50 A	1+N	C	100118	Ex9BN 1PN C50	1/6/72
63 A	1+N	C	100119	Ex9BN 1PN C63	1/6/72

C-Characteristic, 2-pole



Rated current	Poles	Char.	Article No.	Type	Packing
1 A	2	C	100120	Ex9BN 2P C1	1/6/72
2 A	2	C	100121	Ex9BN 2P C2	1/6/72
3 A	2	C	100122	Ex9BN 2P C3	1/6/72
4 A	2	C	100123	Ex9BN 2P C4	1/6/72
6 A	2	C	100124	Ex9BN 2P C6	1/6/72
8 A	2	C	100125	Ex9BN 2P C8	1/6/72
10 A	2	C	100126	Ex9BN 2P C10	1/6/72
13 A	2	C	100127	Ex9BN 2P C13	1/6/72
16 A	2	C	100128	Ex9BN 2P C16	1/6/72
20 A	2	C	100129	Ex9BN 2P C20	1/6/72
25 A	2	C	100130	Ex9BN 2P C25	1/6/72
32 A	2	C	100131	Ex9BN 2P C32	1/6/72
40 A	2	C	100132	Ex9BN 2P C40	1/6/72
50 A	2	C	100133	Ex9BN 2P C50	1/6/72
63 A	2	C	100134	Ex9BN 2P C63	1/6/72

Miniature Circuit Breakers Ex9BN, 6 kA

C-Characteristic, 3-pole



Rated current	Poles	Char.	Article No.	Type	Packing
1 A	3	C	100135	Ex9BN 3P C1	1/4/48
2 A	3	C	100136	Ex9BN 3P C2	1/4/48
3 A	3	C	100137	Ex9BN 3P C3	1/4/48
4 A	3	C	100138	Ex9BN 3P C4	1/4/48
6 A	3	C	100139	Ex9BN 3P C6	1/4/48
8 A	3	C	100140	Ex9BN 3P C8	1/4/48
10 A	3	C	100141	Ex9BN 3P C10	1/4/48
13 A	3	C	100142	Ex9BN 3P C13	1/4/48
16 A	3	C	100143	Ex9BN 3P C16	1/4/48
20 A	3	C	100144	Ex9BN 3P C20	1/4/48
25 A	3	C	100145	Ex9BN 3P C25	1/4/48
32 A	3	C	100146	Ex9BN 3P C32	1/4/48
40 A	3	C	100147	Ex9BN 3P C40	1/4/48
50 A	3	C	100148	Ex9BN 3P C50	1/4/48
63 A	3	C	100149	Ex9BN 3P C63	1/4/48

C-Characteristic, 3+N-pole



Rated current	Poles	Char.	Article No.	Type	Packing
1 A	3+N	C	100150	Ex9BN 3PN C1	1/3/36
2 A	3+N	C	100151	Ex9BN 3PN C2	1/3/36
3 A	3+N	C	100152	Ex9BN 3PN C3	1/3/36
4 A	3+N	C	100153	Ex9BN 3PN C4	1/3/36
6 A	3+N	C	100154	Ex9BN 3PN C6	1/3/36
8 A	3+N	C	100155	Ex9BN 3PN C8	1/3/36
10 A	3+N	C	100156	Ex9BN 3PN C10	1/3/36
13 A	3+N	C	100157	Ex9BN 3PN C13	1/3/36
16 A	3+N	C	100158	Ex9BN 3PN C16	1/3/36
20 A	3+N	C	100159	Ex9BN 3PN C20	1/3/36
25 A	3+N	C	100160	Ex9BN 3PN C25	1/3/36
32 A	3+N	C	100161	Ex9BN 3PN C32	1/3/36
40 A	3+N	C	100162	Ex9BN 3PN C40	1/3/36
50 A	3+N	C	100163	Ex9BN 3PN C50	1/3/36
63 A	3+N	C	100164	Ex9BN 3PN C63	1/3/36

C-Characteristic, 4-pole



Rated current	Poles	Char.	Article No.	Type	Packing
1 A	4	C	100165	Ex9BN 4P C1	1/3/36
2 A	4	C	100166	Ex9BN 4P C2	1/3/36
3 A	4	C	100167	Ex9BN 4P C3	1/3/36
4 A	4	C	100168	Ex9BN 4P C4	1/3/36
6 A	4	C	100169	Ex9BN 4P C6	1/3/36
8 A	4	C	100170	Ex9BN 4P C8	1/3/36
10 A	4	C	100171	Ex9BN 4P C10	1/3/36
13 A	4	C	100172	Ex9BN 4P C13	1/3/36
16 A	4	C	100173	Ex9BN 4P C16	1/3/36
20 A	4	C	100174	Ex9BN 4P C20	1/3/36
25 A	4	C	100175	Ex9BN 4P C25	1/3/36
32 A	4	C	100176	Ex9BN 4P C32	1/3/36
40 A	4	C	100177	Ex9BN 4P C40	1/3/36
50 A	4	C	100178	Ex9BN 4P C50	1/3/36
63 A	4	C	100179	Ex9BN 4P C63	1/3/36

Miniature Circuit Breakers Ex9BN, 6 kA

D-Characteristic, 1-pole



Rated current	Poles	Char.	Article No.	Type	Packing
1 A	1	D	100180	Ex9BN 1P D1	1/12/144
2 A	1	D	100181	Ex9BN 1P D2	1/12/144
3 A	1	D	100182	Ex9BN 1P D3	1/12/144
4 A	1	D	100183	Ex9BN 1P D4	1/12/144
6 A	1	D	100184	Ex9BN 1P D6	1/12/144
8 A	1	D	100185	Ex9BN 1P D8	1/12/144
10 A	1	D	100186	Ex9BN 1P D10	1/12/144
13 A	1	D	100187	Ex9BN 1P D13	1/12/144
16 A	1	D	100188	Ex9BN 1P D16	1/12/144
20 A	1	D	100189	Ex9BN 1P D20	1/12/144
25 A	1	D	100190	Ex9BN 1P D25	1/12/144
32 A	1	D	100191	Ex9BN 1P D32	1/12/144
40 A	1	D	100192	Ex9BN 1P D40	1/12/144
50 A	1	D	100193	Ex9BN 1P D50	1/12/144
63 A	1	D	100194	Ex9BN 1P D63	1/12/144

D-Characteristic, 1+N-pole



Rated current	Poles	Char.	Article No.	Type	Packing
1 A	1+N	D	100195	Ex9BN 1PN D1	1/6/72
2 A	1+N	D	100196	Ex9BN 1PN D2	1/6/72
3 A	1+N	D	100197	Ex9BN 1PN D3	1/6/72
4 A	1+N	D	100198	Ex9BN 1PN D4	1/6/72
6 A	1+N	D	100199	Ex9BN 1PN D6	1/6/72
8 A	1+N	D	100200	Ex9BN 1PN D8	1/6/72
10 A	1+N	D	100201	Ex9BN 1PN D10	1/6/72
13 A	1+N	D	100202	Ex9BN 1PN D13	1/6/72
16 A	1+N	D	100203	Ex9BN 1PN D16	1/6/72
20 A	1+N	D	100204	Ex9BN 1PN D20	1/6/72
25 A	1+N	D	100205	Ex9BN 1PN D25	1/6/72
32 A	1+N	D	100206	Ex9BN 1PN D32	1/6/72
40 A	1+N	D	100207	Ex9BN 1PN D40	1/6/72
50 A	1+N	D	100208	Ex9BN 1PN D50	1/6/72
63 A	1+N	D	100209	Ex9BN 1PN D63	1/6/72

D-Characteristic, 2-pole



Rated current	Poles	Char.	Article No.	Type	Packing
1 A	2	D	100210	Ex9BN 2P D1	1/6/72
2 A	2	D	100211	Ex9BN 2P D2	1/6/72
3 A	2	D	100212	Ex9BN 2P D3	1/6/72
4 A	2	D	100213	Ex9BN 2P D4	1/6/72
6 A	2	D	100214	Ex9BN 2P D6	1/6/72
8 A	2	D	100215	Ex9BN 2P D8	1/6/72
10 A	2	D	100216	Ex9BN 2P D10	1/6/72
13 A	2	D	100217	Ex9BN 2P D13	1/6/72
16 A	2	D	100218	Ex9BN 2P D16	1/6/72
20 A	2	D	100219	Ex9BN 2P D20	1/6/72
25 A	2	D	100220	Ex9BN 2P D25	1/6/72
32 A	2	D	100221	Ex9BN 2P D32	1/6/72
40 A	2	D	100222	Ex9BN 2P D40	1/6/72
50 A	2	D	100223	Ex9BN 2P D50	1/6/72
63 A	2	D	100224	Ex9BN 2P D63	1/6/72

Miniature Circuit Breakers Ex9BN, 6 kA

D-Characteristic, 3-pole



Rated current	Poles	Char.	Article No.	Type	Packing
1 A	3	D	100225	Ex9BN 3P D1	1/4/48
2 A	3	D	100226	Ex9BN 3P D2	1/4/48
3 A	3	D	100227	Ex9BN 3P D3	1/4/48
4 A	3	D	100228	Ex9BN 3P D4	1/4/48
6 A	3	D	100229	Ex9BN 3P D6	1/4/48
8 A	3	D	100230	Ex9BN 3P D8	1/4/48
10 A	3	D	100231	Ex9BN 3P D10	1/4/48
13 A	3	D	100232	Ex9BN 3P D13	1/4/48
16 A	3	D	100233	Ex9BN 3P D16	1/4/48
20 A	3	D	100234	Ex9BN 3P D20	1/4/48
25 A	3	D	100235	Ex9BN 3P D25	1/4/48
32 A	3	D	100236	Ex9BN 3P D32	1/4/48
40 A	3	D	100237	Ex9BN 3P D40	1/4/48
50 A	3	D	100238	Ex9BN 3P D50	1/4/48
63 A	3	D	100239	Ex9BN 3P D63	1/4/48

D-Characteristic, 3+N-pole



Rated current	Poles	Char.	Article No.	Type	Packing
1 A	3+N	D	100240	Ex9BN 3PN D1	1/3/36
2 A	3+N	D	100241	Ex9BN 3PN D2	1/3/36
3 A	3+N	D	100242	Ex9BN 3PN D3	1/3/36
4 A	3+N	D	100243	Ex9BN 3PN D4	1/3/36
6 A	3+N	D	100244	Ex9BN 3PN D6	1/3/36
8 A	3+N	D	100245	Ex9BN 3PN D8	1/3/36
10 A	3+N	D	100246	Ex9BN 3PN D10	1/3/36
13 A	3+N	D	100247	Ex9BN 3PN D13	1/3/36
16 A	3+N	D	100248	Ex9BN 3PN D16	1/3/36
20 A	3+N	D	100249	Ex9BN 3PN D20	1/3/36
25 A	3+N	D	100250	Ex9BN 3PN D25	1/3/36
32 A	3+N	D	100251	Ex9BN 3PN D32	1/3/36
40 A	3+N	D	100252	Ex9BN 3PN D40	1/3/36
50 A	3+N	D	100253	Ex9BN 3PN D50	1/3/36
63 A	3+N	D	100254	Ex9BN 3PN D63	1/3/36

D-Characteristic, 4-pole



Rated current	Poles	Char.	Article No.	Type	Packing
1 A	4	D	100255	Ex9BN 4P D1	1/3/36
2 A	4	D	100256	Ex9BN 4P D2	1/3/36
3 A	4	D	100257	Ex9BN 4P D3	1/3/36
4 A	4	D	100258	Ex9BN 4P D4	1/3/36
6 A	4	D	100259	Ex9BN 4P D6	1/3/36
8 A	4	D	100260	Ex9BN 4P D8	1/3/36
10 A	4	D	100261	Ex9BN 4P D10	1/3/36
13 A	4	D	100262	Ex9BN 4P D13	1/3/36
16 A	4	D	100263	Ex9BN 4P D16	1/3/36
20 A	4	D	100264	Ex9BN 4P D20	1/3/36
25 A	4	D	100265	Ex9BN 4P D25	1/3/36
32 A	4	D	100266	Ex9BN 4P D32	1/3/36
40 A	4	D	100267	Ex9BN 4P D40	1/3/36
50 A	4	D	100268	Ex9BN 4P D50	1/3/36
63 A	4	D	100269	Ex9BN 4P D63	1/3/36

Slim MCBs Ex9B40J, 6 kA



- Slim Miniature Circuit Breakers according to IEC/EN 60898-1
- Rated short circuit breaking capacity 6 kA
- 1 up to 4-pole versions
- Tripping characteristics B, C
- Rated current up to 40 A
- Rated operational voltage 230/400 V AC,
- Wide range of accessories

Slim miniature circuit breakers Ex9B40J are devices suitable for domestic as well as commercial applications. The 3/4 module width - 13.5mm width per pole instead of 18mm of regular devices, makes this series the best option for space demanding installations.

It has been preserved the internal structure of the regular Ex9B product family in the slim miniature circuit breakers, making the Ex9B40J full compatible with the accessories of the regular circuit breakers: shunt trip releases, undervoltage and overvoltage releases, auxiliary contacts and alarm contacts. It can be used up to three units of auxiliary or alarm contacts plus up to two release units.

Type Key

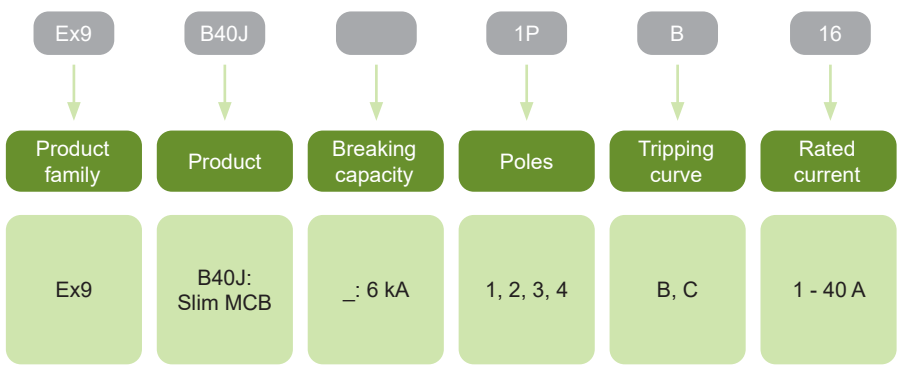

Certification marks



Slim MCBs Ex9B40J, 6 kA

Accessories

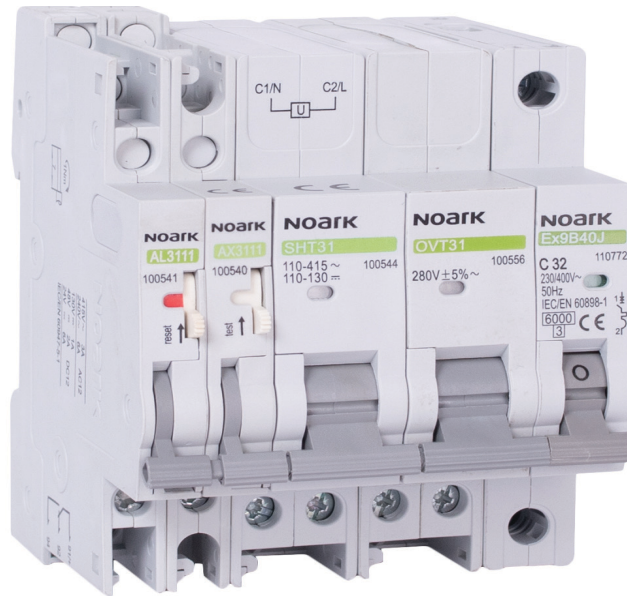

Auxiliary or signal contacts
AX, AL, AXL
Up to 3 units

Voltage or trip releases
SHT, UVT, OVT
Up to 2 units

MCB
Ex9B40J
1, 2, 3, 4-pole

Auxiliary contacts AX3111, AX3122

see page 132

Alarm contact AL3111

see page 132

Auxiliary and alarm contact AXL31

see page 132

Shunt trip releases SHT31, SHT3111

see page 132

Undervoltage releases UVT31, UVT3101, UVT3110

see page 133

Overvoltage release OVT31

see page 133

Slim MCBs Ex9B40J, 6 kA

B-Characteristic, 1-pole



Rated current	Poles	Char.	Article No.	Type	Packing
1 A	1	B	110719	Ex9B40J 1P B1	1/16/192
2 A	1	B	110720	Ex9B40J 1P B2	1/16/192
3 A	1	B	110721	Ex9B40J 1P B3	1/16/192
4 A	1	B	110722	Ex9B40J 1P B4	1/16/192
6 A	1	B	110723	Ex9B40J 1P B6	1/16/192
10 A	1	B	110724	Ex9B40J 1P B10	1/16/192
16 A	1	B	110725	Ex9B40J 1P B16	1/16/192
20 A	1	B	110726	Ex9B40J 1P B20	1/16/192
25 A	1	B	110727	Ex9B40J 1P B25	1/16/192
32 A	1	B	110728	Ex9B40J 1P B32	1/16/192
40 A	1	B	110729	Ex9B40J 1P B40	1/16/192

B-Characteristic, 2-pole



Rated current	Poles	Char.	Article No.	Type	Packing
1 A	2	B	110730	Ex9B40J 2P B1	1/8/96
2 A	2	B	110731	Ex9B40J 2P B2	1/8/96
3 A	2	B	110732	Ex9B40J 2P B3	1/8/96
4 A	2	B	110733	Ex9B40J 2P B4	1/8/96
6 A	2	B	110734	Ex9B40J 2P B6	1/8/96
10 A	2	B	110735	Ex9B40J 2P B10	1/8/96
16 A	2	B	110736	Ex9B40J 2P B16	1/8/96
20 A	2	B	110737	Ex9B40J 2P B20	1/8/96
25 A	2	B	110738	Ex9B40J 2P B25	1/8/96
32 A	2	B	110739	Ex9B40J 2P B32	1/8/96
40 A	2	B	110740	Ex9B40J 2P B40	1/8/96

B-Characteristic, 3-pole



Rated current	Poles	Char.	Article No.	Type	Packing
1 A	3	B	110741	Ex9B40J 3P B1	1/5/60
2 A	3	B	110742	Ex9B40J 3P B2	1/5/60
3 A	3	B	110743	Ex9B40J 3P B3	1/5/60
4 A	3	B	110744	Ex9B40J 3P B4	1/5/60
6 A	3	B	110745	Ex9B40J 3P B6	1/5/60
10 A	3	B	110746	Ex9B40J 3P B10	1/5/60
16 A	3	B	110747	Ex9B40J 3P B16	1/5/60
20 A	3	B	110748	Ex9B40J 3P B20	1/5/60
25 A	3	B	110749	Ex9B40J 3P B25	1/5/60
32 A	3	B	110750	Ex9B40J 3P B32	1/5/60
40 A	3	B	110751	Ex9B40J 3P B40	1/5/60

B-Characteristic, 4-pole



Rated current	Poles	Char.	Article No.	Type	Packing
1 A	4	B	110752	Ex9B40J 4P B1	1/4/48
2 A	4	B	110753	Ex9B40J 4P B2	1/4/48
3 A	4	B	110754	Ex9B40J 4P B3	1/4/48
4 A	4	B	110755	Ex9B40J 4P B4	1/4/48
6 A	4	B	110756	Ex9B40J 4P B6	1/4/48
10 A	4	B	110757	Ex9B40J 4P B10	1/4/48
16 A	4	B	110758	Ex9B40J 4P B16	1/4/48
20 A	4	B	110759	Ex9B40J 4P B20	1/4/48
25 A	4	B	110760	Ex9B40J 4P B20	1/4/48
32 A	4	B	110761	Ex9B40J 4P B32	1/4/48
40 A	4	B	110762	Ex9B40J 4P B40	1/4/48

Slim MCBs Ex9B40J, 6 kA

C-Characteristic, 1-pole



Rated current	Poles	Char.	Article No.	Type	Packing
1 A	1	C	110763	Ex9B40J 1P C1	1/16/192
2 A	1	C	110764	Ex9B40J 1P C2	1/16/192
3 A	1	C	110765	Ex9B40J 1P C3	1/16/192
4 A	1	C	110766	Ex9B40J 1P C4	1/16/192
6 A	1	C	110767	Ex9B40J 1P C6	1/16/192
10 A	1	C	110768	Ex9B40J 1P C10	1/16/192
16 A	1	C	110769	Ex9B40J 1P C16	1/16/192
20 A	1	C	110770	Ex9B40J 1P C20	1/16/192
25 A	1	C	110771	Ex9B40J 1P C20	1/16/192
32 A	1	C	110772	Ex9B40J 1P C32	1/16/192
40 A	1	C	110773	Ex9B40J 1P C40	1/16/192

C-Characteristic, 2-pole



Rated current	Poles	Char.	Article No.	Type	Packing
1 A	2	C	110774	Ex9B40J 2P C1	1/8/96
2 A	2	C	110775	Ex9B40J 2P C2	1/8/96
3 A	2	C	110776	Ex9B40J 2P C3	1/8/96
4 A	2	C	110777	Ex9B40J 2P C4	1/8/96
6 A	2	C	110778	Ex9B40J 2P C6	1/8/96
10 A	2	C	110779	Ex9B40J 2P C10	1/8/96
16 A	2	C	110780	Ex9B40J 2P C16	1/8/96
20 A	2	C	110781	Ex9B40J 2P C20	1/8/96
25 A	2	C	110782	Ex9B40J 2P C25	1/8/96
32 A	2	C	110783	Ex9B40J 2P C32	1/8/96
40 A	2	C	110784	Ex9B40J 2P C40	1/8/96

C-Characteristic, 3-pole



Rated current	Poles	Char.	Article No.	Type	Packing
1 A	3	C	110785	Ex9B40J 3P C1	1/5/60
2 A	3	C	110786	Ex9B40J 3P C2	1/5/60
3 A	3	C	110787	Ex9B40J 3P C3	1/5/60
4 A	3	C	110788	Ex9B40J 3P C4	1/5/60
6 A	3	C	110789	Ex9B40J 3P C6	1/5/60
10 A	3	C	110790	Ex9B40J 3P C10	1/5/60
16 A	3	C	110791	Ex9B40J 3P C16	1/5/60
20 A	3	C	110792	Ex9B40J 3P C20	1/5/60
25 A	3	C	110793	Ex9B40J 3P C25	1/5/60
32 A	3	C	110794	Ex9B40J 3P C32	1/5/60
40 A	3	C	110795	Ex9B40J 3P C40	1/5/60

C-Characteristic, 4-pole



Rated current	Poles	Char.	Article No.	Type	Packing
1 A	4	C	110796	Ex9B40J 4P C1	1/4/48
2 A	4	C	110797	Ex9B40J 4P C2	1/4/48
3 A	4	C	110798	Ex9B40J 4P C3	1/4/48
4 A	4	C	110799	Ex9B40J 4P C4	1/4/48
6 A	4	C	110800	Ex9B40J 4P C6	1/4/48
10 A	4	C	110801	Ex9B40J 4P C10	1/4/48
16 A	4	C	110802	Ex9B40J 4P C16	1/4/48
20 A	4	C	110803	Ex9B40J 4P C20	1/4/48
25 A	4	C	110804	Ex9B40J 4P C25	1/4/48
32 A	4	C	110805	Ex9B40J 4P C32	1/4/48
40 A	4	C	110806	Ex9B40J 4P C40	1/4/48

Miniature Circuit Breakers Ex9B125



- Miniature Circuit Breakers up to 100 A
- Tested according to EN 60947-2
- High rated breaking capacities up to 25 kA
- 1 up to 4-pole versions
- Rated operating voltage 230/400 V AC
- Wide range of accessories
- Toggle colour according to rated current I_n

Miniature Circuit Breakers Ex9B125 are suitable mainly for power distribution and industrial applications for short-circuit and overload current protection with rated current up to 100 A and a very high rated breaking capacities (tested according to EN 60947-2).

These breakers can be combined with wide range of accessories (same as for Ex9B breakers) including auxiliary and signal contacts, shunt trip releases, undervoltage and overvoltage releases. It is possible to create diversified combination of accessories.

Type Key

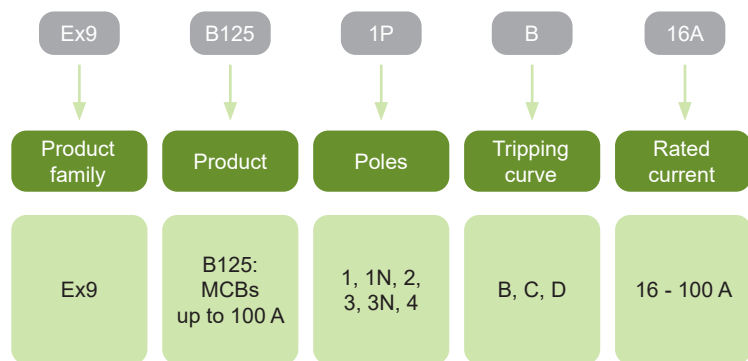

Certification marks



Miniature Circuit Breakers Ex9B125

Accessories



Auxiliary or signal
contacts
AX, AL, AXL
Up to 3 units

Voltage or trip releases
SHT, UVT, OVT
Up to 2 units

MCB
Ex9B125
1, 1+N, 2, 3, 3+N, 4-pole

Auxiliary contacts AX3111, AX3122

see page 132

Alarm contact AL3111

see page 132

Auxiliary and alarm contact AXL31

see page 132

Shunt trip releases SHT31, SHT3111

see page 132

Undervoltage releases UVT31, UVT3101, UVT3110

see page 133

Overtoltage release OVT31

see page 133

All accessories are mounted to the breaker from the left side and are identical for devices of the line Ex9B, Ex9PN and Ex9IP.

Miniature Circuit Breakers Ex9B125

B-Characteristic, 1-pole

- Rated ultimate short-circuit breaking capacity I_{cu} (EN 60947-2)
 for I_n 16 - 63 A = 25 kA
 for I_n 80, 100 A = 20 kA



Rated current	Poles	Char.	Article No.	Type	Packing
16 A	1	B	102684	Ex9B125 1P B16A	1/12/108
20 A	1	B	102685	Ex9B125 1P B20A	1/12/108
25 A	1	B	102686	Ex9B125 1P B25A	1/12/108
32 A	1	B	102687	Ex9B125 1P B32A	1/12/108
40 A	1	B	102688	Ex9B125 1P B40A	1/12/108
50 A	1	B	102689	Ex9B125 1P B50A	1/12/108
63 A	1	B	102690	Ex9B125 1P B63A	1/12/108
80 A	1	B	102691	Ex9B125 1P B80A	1/12/108
100 A	1	B	102692	Ex9B125 1P B100A	1/12/108

B-Characteristic, 1+N-pole

- Rated ultimate short-circuit breaking capacity I_{cu} (EN 60947-2)
 for I_n 16 - 63 A = 25 kA
 for I_n 80, 100 A = 20 kA



Rated current	Poles	Char.	Article No.	Type	Packing
16 A	1+N	B	102714	Ex9B125 1PN B16A	1/6/54
20 A	1+N	B	102715	Ex9B125 1PN B20A	1/6/54
25 A	1+N	B	102716	Ex9B125 1PN B25A	1/6/54
32 A	1+N	B	102717	Ex9B125 1PN B32A	1/6/54
40 A	1+N	B	102718	Ex9B125 1PN B40A	1/6/54
50 A	1+N	B	102719	Ex9B125 1PN B50A	1/6/54
63 A	1+N	B	102720	Ex9B125 1PN B63A	1/6/54
80 A	1+N	B	102721	Ex9B125 1PN B80A	1/6/54
100 A	1+N	B	102722	Ex9B125 1PN B100A	1/6/54

B-Characteristic, 2-pole

- Rated ultimate short-circuit breaking capacity I_{cu} (EN 60947-2)
 for I_n 16 - 63 A = 25 kA
 for I_n 80, 100 A = 20 kA



Rated current	Poles	Char.	Article No.	Type	Packing
16 A	2	B	102744	Ex9B125 2P B16A	1/6/54
20 A	2	B	102745	Ex9B125 2P B20A	1/6/54
25 A	2	B	102746	Ex9B125 2P B25A	1/6/54
32 A	2	B	102747	Ex9B125 2P B32A	1/6/54
40 A	2	B	102748	Ex9B125 2P B40A	1/6/54
50 A	2	B	102749	Ex9B125 2P B50A	1/6/54
63 A	2	B	102750	Ex9B125 2P B63A	1/6/54
80 A	2	B	102751	Ex9B125 2P B80A	1/6/54
100 A	2	B	102752	Ex9B125 2P B100A	1/6/54

Miniature Circuit Breakers Ex9B125

B-Characteristic, 3-pole

- Rated ultimate short-circuit breaking capacity I_{cu} (EN 60947-2)
 - for I_n 16 - 63 A = 25 kA
 - for I_n 80, 100 A = 20 kA



Rated current	Poles	Char.	Article No.	Type	Packing
16 A	3	B	102774	Ex9B125 3P B16A	1/4/36
20 A	3	B	102775	Ex9B125 3P B20A	1/4/36
25 A	3	B	102776	Ex9B125 3P B25A	1/4/36
32 A	3	B	102777	Ex9B125 3P B32A	1/4/36
40 A	3	B	102778	Ex9B125 3P B40A	1/4/36
50 A	3	B	102779	Ex9B125 3P B50A	1/4/36
63 A	3	B	102780	Ex9B125 3P B63A	1/4/36
80 A	3	B	102781	Ex9B125 3P B80A	1/4/36
100 A	3	B	102782	Ex9B125 3P B100A	1/4/36

B-Characteristic, 3+N-pole

- Rated ultimate short-circuit breaking capacity I_{cu} (EN 60947-2)
 - for I_n 16 - 63 A = 25 kA
 - for I_n 80, 100 A = 20 kA



Rated current	Poles	Char.	Article No.	Type	Packing
16 A	3+N	B	102804	Ex9B125 3PN B16A	1/3/27
20 A	3+N	B	102805	Ex9B125 3PN B20A	1/3/27
25 A	3+N	B	102806	Ex9B125 3PN B25A	1/3/27
32 A	3+N	B	102807	Ex9B125 3PN B32A	1/3/27
40 A	3+N	B	102808	Ex9B125 3PN B40A	1/3/27
50 A	3+N	B	102809	Ex9B125 3PN B50A	1/3/27
63 A	3+N	B	102810	Ex9B125 3PN B63A	1/3/27
80 A	3+N	B	102811	Ex9B125 3PN B80A	1/3/27
100 A	3+N	B	102812	Ex9B125 3PN B100A	1/3/27

B-Characteristic, 4-pole

- Rated ultimate short-circuit breaking capacity I_{cu} (EN 60947-2)
 - for I_n 16 - 63 A = 25 kA
 - for I_n 80, 100 A = 20 kA



Rated current	Poles	Char.	Article No.	Type	Packing
16 A	4	B	102834	Ex9B125 4P B16A	1/3/27
20 A	4	B	102835	Ex9B125 4P B20A	1/3/27
25 A	4	B	102836	Ex9B125 4P B25A	1/3/27
32 A	4	B	102837	Ex9B125 4P B32A	1/3/27
40 A	4	B	102838	Ex9B125 4P B40A	1/3/27
50 A	4	B	102839	Ex9B125 4P B50A	1/3/27
63 A	4	B	102840	Ex9B125 4P B63A	1/3/27
80 A	4	B	102841	Ex9B125 4P B80A	1/3/27
100 A	4	B	102842	Ex9B125 4P B100A	1/3/27

Miniature Circuit Breakers Ex9B125

C-Characteristic, 1-pole

- Rated ultimate short-circuit breaking capacity I_{cu} (EN 60947-2)
 for I_n 16 - 63 A = 25 kA
 for I_n 80, 100 A = 20 kA



Rated current	Poles	Char.	Article No.	Type	Packing
16 A	1	C	102694	Ex9B125 1P C16A	1/12/108
20 A	1	C	102695	Ex9B125 1P C20A	1/12/108
25 A	1	C	102696	Ex9B125 1P C25A	1/12/108
32 A	1	C	102697	Ex9B125 1P C32A	1/12/108
40 A	1	C	102698	Ex9B125 1P C40A	1/12/108
50 A	1	C	102699	Ex9B125 1P C50A	1/12/108
63 A	1	C	102700	Ex9B125 1P C63A	1/12/108
80 A	1	C	102701	Ex9B125 1P C80A	1/12/108
100 A	1	C	102702	Ex9B125 1P C100A	1/12/108

C-Characteristic, 1+N-pole

- Rated ultimate short-circuit breaking capacity I_{cu} (EN 60947-2)
 for I_n 16 - 63 A = 25 kA
 for I_n 80, 100 A = 20 kA



Rated current	Poles	Char.	Article No.	Type	Packing
16 A	1+N	C	102724	Ex9B125 1PN C16A	1/6/54
20 A	1+N	C	102725	Ex9B125 1PN C20A	1/6/54
25 A	1+N	C	102726	Ex9B125 1PN C25A	1/6/54
32 A	1+N	C	102727	Ex9B125 1PN C32A	1/6/54
40 A	1+N	C	102728	Ex9B125 1PN C40A	1/6/54
50 A	1+N	C	102729	Ex9B125 1PN C50A	1/6/54
63 A	1+N	C	102730	Ex9B125 1PN C63A	1/6/54
80 A	1+N	C	102731	Ex9B125 1PN C80A	1/6/54
100 A	1+N	C	102732	Ex9B125 1PN C100A	1/6/54

C-Characteristic, 2-pole

- Rated ultimate short-circuit breaking capacity I_{cu} (EN 60947-2)
 for I_n 16 - 63 A = 25 kA
 for I_n 80, 100 A = 20 kA



Rated current	Poles	Char.	Article No.	Type	Packing
16 A	2	C	102754	Ex9B125 2P C16A	1/6/54
20 A	2	C	102755	Ex9B125 2P C20A	1/6/54
25 A	2	C	102756	Ex9B125 2P C25A	1/6/54
32 A	2	C	102757	Ex9B125 2P C32A	1/6/54
40 A	2	C	102758	Ex9B125 2P C40A	1/6/54
50 A	2	C	102759	Ex9B125 2P C50A	1/6/54
63 A	2	C	102760	Ex9B125 2P C63A	1/6/54
80 A	2	C	102761	Ex9B125 2P C80A	1/6/54
100 A	2	C	102762	Ex9B125 2P C100A	1/6/54

Miniature Circuit Breakers Ex9B125

C-Characteristic, 3-pole

- Rated ultimate short-circuit breaking capacity I_{cu} (EN 60947-2)
for I_n 16 - 63 A = 25 kA
for I_n 80, 100 A = 20 kA



Rated current	Poles	Char.	Article No.	Type	Packing
16 A	3	C	102784	Ex9B125 3P C16A	1/4/36
20 A	3	C	102785	Ex9B125 3P C20A	1/4/36
25 A	3	C	102786	Ex9B125 3P C25A	1/4/36
32 A	3	C	102787	Ex9B125 3P C32A	1/4/36
40 A	3	C	102788	Ex9B125 3P C40A	1/4/36
50 A	3	C	102789	Ex9B125 3P C50A	1/4/36
63 A	3	C	102790	Ex9B125 3P C63A	1/4/36
80 A	3	C	102791	Ex9B125 3P C80A	1/4/36
100 A	3	C	102792	Ex9B125 3P C100A	1/4/36

C-Characteristic, 3+N-pole

- Rated ultimate short-circuit breaking capacity I_{cu} (EN 60947-2)
for I_n 16 - 63 A = 25 kA
for I_n 80, 100 A = 20 kA



Rated current	Poles	Char.	Article No.	Type	Packing
16 A	3+N	C	102814	Ex9B125 3PN C16A	1/3/27
20 A	3+N	C	102815	Ex9B125 3PN C20A	1/3/27
25 A	3+N	C	102816	Ex9B125 3PN C25A	1/3/27
32 A	3+N	C	102817	Ex9B125 3PN C32A	1/3/27
40 A	3+N	C	102818	Ex9B125 3PN C40A	1/3/27
50 A	3+N	C	102819	Ex9B125 3PN C50A	1/3/27
63 A	3+N	C	102820	Ex9B125 3PN C63A	1/3/27
80 A	3+N	C	102821	Ex9B125 3PN C80A	1/3/27
100 A	3+N	C	102822	Ex9B125 3PN C100A	1/3/27

C-Characteristic, 4-pole

- Rated ultimate short-circuit breaking capacity I_{cu} (EN 60947-2)
for I_n 16 - 63 A = 25 kA
for I_n 80, 100 A = 20 kA



Rated current	Poles	Char.	Article No.	Type	Packing
16 A	4	C	102844	Ex9B125 4P C16A	1/3/27
20 A	4	C	102845	Ex9B125 4P C20A	1/3/27
25 A	4	C	102846	Ex9B125 4P C25A	1/3/27
32 A	4	C	102847	Ex9B125 4P C32A	1/3/27
40 A	4	C	102848	Ex9B125 4P C40A	1/3/27
50 A	4	C	102849	Ex9B125 4P C50A	1/3/27
63 A	4	C	102850	Ex9B125 4P C63A	1/3/27
80 A	4	C	102851	Ex9B125 4P C80A	1/3/27
100 A	4	C	102852	Ex9B125 4P C100A	1/3/27

Miniature Circuit Breakers Ex9B125

D-Characteristic, 1-pole

- Rated ultimate short-circuit breaking capacity I_{cu} (EN 60947-2)
for I_n 16 - 63 A = 25 kA
for I_n 80, 100 A = 20 kA



Rated current	Poles	Char.	Article No.	Type	Packing
16 A	1	D	102704	Ex9B125 1P D16A	1/12/108
20 A	1	D	102705	Ex9B125 1P D20A	1/12/108
25 A	1	D	102706	Ex9B125 1P D25A	1/12/108
32 A	1	D	102707	Ex9B125 1P D32A	1/12/108
40 A	1	D	102708	Ex9B125 1P D40A	1/12/108
50 A	1	D	102709	Ex9B125 1P D50A	1/12/108
63 A	1	D	102710	Ex9B125 1P D63A	1/12/108
80 A	1	D	102711	Ex9B125 1P D80A	1/12/108
100 A	1	D	102712	Ex9B125 1P D100A	1/12/108

D-Characteristic, 1+N-pole

- Rated ultimate short-circuit breaking capacity I_{cu} (EN 60947-2)
for I_n 16 - 63 A = 25 kA
for I_n 80, 100 A = 20 kA



Rated current	Poles	Char.	Article No.	Type	Packing
16 A	1+N	D	102734	Ex9B125 1PN D16A	1/6/54
20 A	1+N	D	102735	Ex9B125 1PN D20A	1/6/54
25 A	1+N	D	102736	Ex9B125 1PN D25A	1/6/54
32 A	1+N	D	102737	Ex9B125 1PN D32A	1/6/54
40 A	1+N	D	102738	Ex9B125 1PN D40A	1/6/54
50 A	1+N	D	102739	Ex9B125 1PN D50A	1/6/54
63 A	1+N	D	102740	Ex9B125 1PN D63A	1/6/54
80 A	1+N	D	102741	Ex9B125 1PN D80A	1/6/54
100 A	1+N	D	102742	Ex9B125 1PN D100A	1/6/54

D-Characteristic, 2-pole

- Rated ultimate short-circuit breaking capacity I_{cu} (EN 60947-2)
for I_n 16 - 63 A = 25 kA
for I_n 80, 100 A = 20 kA



Rated current	Poles	Char.	Article No.	Type	Packing
16 A	2	D	102764	Ex9B125 2P D16A	1/6/54
20 A	2	D	102765	Ex9B125 2P D20A	1/6/54
25 A	2	D	102766	Ex9B125 2P D25A	1/6/54
32 A	2	D	102767	Ex9B125 2P D32A	1/6/54
40 A	2	D	102768	Ex9B125 2P D40A	1/6/54
50 A	2	D	102769	Ex9B125 2P D50A	1/6/54
63 A	2	D	102770	Ex9B125 2P D63A	1/6/54
80 A	2	D	102771	Ex9B125 2P D80A	1/6/54
100 A	2	D	102772	Ex9B125 2P D100A	1/6/54

Miniature Circuit Breakers Ex9B125

D-Characteristic, 3-pole

- Rated ultimate short-circuit breaking capacity I_{cu} (EN 60947-2)
 - for I_n 16 - 63 A = 25 kA
 - for I_n 80, 100 A = 20 kA



Rated current	Poles	Char.	Article No.	Type	Packing
16 A	3	D	102794	Ex9B125 3P D16A	1/4/36
20 A	3	D	102795	Ex9B125 3P D20A	1/4/36
25 A	3	D	102796	Ex9B125 3P D25A	1/4/36
32 A	3	D	102797	Ex9B125 3P D32A	1/4/36
40 A	3	D	102798	Ex9B125 3P D40A	1/4/36
50 A	3	D	102799	Ex9B125 3P D50A	1/4/36
63 A	3	D	102800	Ex9B125 3P D63A	1/4/36
80 A	3	D	102801	Ex9B125 3P D80A	1/4/36
100 A	3	D	102802	Ex9B125 3P D100A	1/4/36

D-Characteristic, 3+N-pole

- Rated ultimate short-circuit breaking capacity I_{cu} (EN 60947-2)
 - for I_n 16 - 63 A = 25 kA
 - for I_n 80, 100 A = 20 kA



Rated current	Poles	Char.	Article No.	Type	Packing
16 A	3+N	D	102824	Ex9B125 3PN D16A	1/3/27
20 A	3+N	D	102825	Ex9B125 3PN D20A	1/3/27
25 A	3+N	D	102826	Ex9B125 3PN D25A	1/3/27
32 A	3+N	D	102827	Ex9B125 3PN D32A	1/3/27
40 A	3+N	D	102828	Ex9B125 3PN D40A	1/3/27
50 A	3+N	D	102829	Ex9B125 3PN D50A	1/3/27
63 A	3+N	D	102830	Ex9B125 3PN D63A	1/3/27
80 A	3+N	D	102831	Ex9B125 3PN D80A	1/3/27
100 A	3+N	D	102832	Ex9B125 3PN D100A	1/3/27

D-Characteristic, 4-pole

- Rated ultimate short-circuit breaking capacity I_{cu} (EN 60947-2)
 - for I_n 16 - 63 A = 25 kA
 - for I_n 80, 100 A = 20 kA



Rated current	Poles	Char.	Article No.	Type	Packing
16 A	4	D	102854	Ex9B125 4P D16A	1/3/27
20 A	4	D	102855	Ex9B125 4P D20A	1/3/27
25 A	4	D	102856	Ex9B125 4P D25A	1/3/27
32 A	4	D	102857	Ex9B125 4P D32A	1/3/27
40 A	4	D	102858	Ex9B125 4P D40A	1/3/27
50 A	4	D	102859	Ex9B125 4P D50A	1/3/27
63 A	4	D	102860	Ex9B125 4P D63A	1/3/27
80 A	4	D	102861	Ex9B125 4P D80A	1/3/27
100 A	4	D	102862	Ex9B125 4P D100A	1/3/27

Miniature Circuit Breakers Ex9PN



- Miniature Circuit Breakers
- Tested according to IEC / EN 60898-1
- 1+N pole in one module design
- Rated short circuit breaking capacity I_{cn} 4.5 kA (-S version) and 6 kA (-N version)
- Tripping characteristics B, C
- Rated current up to 40 A
- Rated operational voltage 230/400 V AC, 48 V DC (per pole)
- Wide range of accessories

Ex9PN miniature circuit breakers can be combined with wide range of accessories including auxiliary and signal contacts, shunt trip release, undervoltage and overvoltage release. It is possible to create diversified combination of accessories. These combinations are only limited by total number, not by the type of accessories - all components fit together. It can be used up to three units of auxiliary or alarm contacts plus up to two units for release units.

Type Key

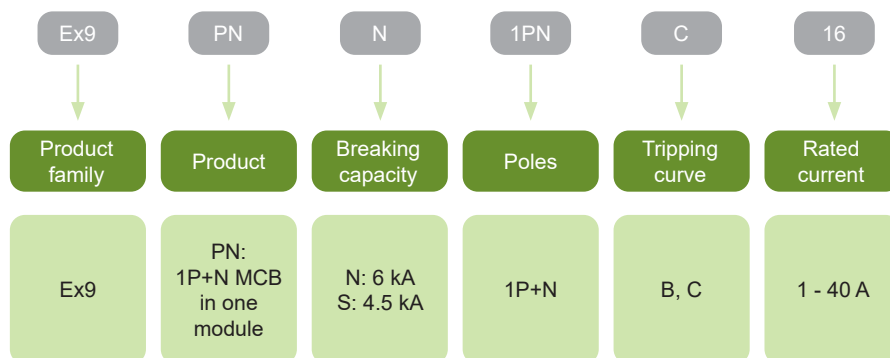

Certification marks



Miniature Circuit Breakers Ex9PN

Accessories



Auxiliary or signal contacts
AX, AL, AXL
Up to 3 units

Voltage or trip releases
SHT, UVT, OVT
Up to 2 units

MCB
Ex9PN
1+N-pole

Auxiliary contacts AX3111, AX3122

see page 132

Alarm contact AL3111

see page 132

Auxiliary and alarm contact AXL31

see page 132

Shunt trip releases SHT31, SHT3111

see page 132

Undervoltage releases UVT31, UVT3101, UVT3110

see page 133

Overvoltage release OVT31

see page 133

All accessories are mounted from the left side and are identical for devices of the line Ex9B and Ex9IP.

Miniature Circuit Breakers Ex9PN

B-Characteristic, 6 kA



Rated current	Poles	Char.	Article No.	Type	Packing
1 A	1+N	B	101600	Ex9PN-N 1PN B1	1/12/144
2 A	1+N	B	101601	Ex9PN-N 1PN B2	1/12/144
3 A	1+N	B	101602	Ex9PN-N 1PN B3	1/12/144
4 A	1+N	B	101603	Ex9PN-N 1PN B4	1/12/144
6 A	1+N	B	101604	Ex9PN-N 1PN B6	1/12/144
10 A	1+N	B	101605	Ex9PN-N 1PN B10	1/12/144
13 A	1+N	B	102354	Ex9PN-N 1PN B13	1/12/144
16 A	1+N	B	101606	Ex9PN-N 1PN B16	1/12/144
20 A	1+N	B	101607	Ex9PN-N 1PN B20	1/12/144
25 A	1+N	B	101608	Ex9PN-N 1PN B25	1/12/144
32 A	1+N	B	101609	Ex9PN-N 1PN B32	1/12/144
40 A	1+N	B	101610	Ex9PN-N 1PN B40	1/12/144

C-Characteristic, 6 kA



Rated current	Poles	Char.	Article No.	Type	Packing
1 A	1+N	C	101611	Ex9PN-N 1PN C1	1/12/144
2 A	1+N	C	101612	Ex9PN-N 1PN C2	1/12/144
3 A	1+N	C	101613	Ex9PN-N 1PN C3	1/12/144
4 A	1+N	C	101614	Ex9PN-N 1PN C4	1/12/144
6 A	1+N	C	101615	Ex9PN-N 1PN C6	1/12/144
10 A	1+N	C	101616	Ex9PN-N 1PN C10	1/12/144
13 A	1+N	C	102355	Ex9PN-N 1PN C13	1/12/144
16 A	1+N	C	101617	Ex9PN-N 1PN C16	1/12/144
20 A	1+N	C	101618	Ex9PN-N 1PN C20	1/12/144
25 A	1+N	C	101619	Ex9PN-N 1PN C25	1/12/144
32 A	1+N	C	101620	Ex9PN-N 1PN C32	1/12/144
40 A	1+N	C	101621	Ex9PN-N 1PN C40	1/12/144

Miniature Circuit Breakers Ex9PN

B-Characteristic, 4.5 kA



Rated current	Poles	Char.	Article No.	Type	Packing
1 A	1+N	B	101578	Ex9PN-S 1PN B1	1/12/144
2 A	1+N	B	101579	Ex9PN-S 1PN B2	1/12/144
3 A	1+N	B	101580	Ex9PN-S 1PN B3	1/12/144
4 A	1+N	B	101581	Ex9PN-S 1PN B4	1/12/144
6 A	1+N	B	101582	Ex9PN-S 1PN B6	1/12/144
10 A	1+N	B	101583	Ex9PN-S 1PN B10	1/12/144
13 A	1+N	B	102352	Ex9PN-S 1PN B13	1/12/144
16 A	1+N	B	101584	Ex9PN-S 1PN B16	1/12/144
20 A	1+N	B	101585	Ex9PN-S 1PN B20	1/12/144
25 A	1+N	B	101586	Ex9PN-S 1PN B25	1/12/144
32 A	1+N	B	101587	Ex9PN-S 1PN B32	1/12/144
40 A	1+N	B	101588	Ex9PN-S 1PN B40	1/12/144

C-Characteristic, 4.5 kA



Rated current	Poles	Char.	Article No.	Type	Packing
1 A	1+N	C	101589	Ex9PN-S 1PN C1	1/12/144
2 A	1+N	C	101590	Ex9PN-S 1PN C2	1/12/144
3 A	1+N	C	101591	Ex9PN-S 1PN C3	1/12/144
4 A	1+N	C	101592	Ex9PN-S 1PN C4	1/12/144
6 A	1+N	C	101593	Ex9PN-S 1PN C6	1/12/144
10 A	1+N	C	101594	Ex9PN-S 1PN C10	1/12/144
13 A	1+N	C	102353	Ex9PN-S 1PN C13	1/12/144
16 A	1+N	C	101595	Ex9PN-S 1PN C16	1/12/144
20 A	1+N	C	101596	Ex9PN-S 1PN C20	1/12/144
25 A	1+N	C	101597	Ex9PN-S 1PN C25	1/12/144
32 A	1+N	C	101598	Ex9PN-S 1PN C32	1/12/144
40 A	1+N	C	101599	Ex9PN-S 1PN C40	1/12/144

DC Miniature Circuit Breakers Ex9BP-JX



- General purpose Direct Current (DC) Miniature Circuit Breakers
- Tested according to EN 60947-2
- Rated operating voltage 250 V DC per pole
- Rated current up to 63 A
- Rated short circuit breaking capacity 10 kA
- 1 to 4 pole versions
- Tripping characteristics C, K
- Wide range of accessories

General purpose DC Miniature Circuit Breakers Ex9BP-JX are designed for general direct current applications. Due to their polarity dependence it is necessary to respect the polarity of the current.

Type Key

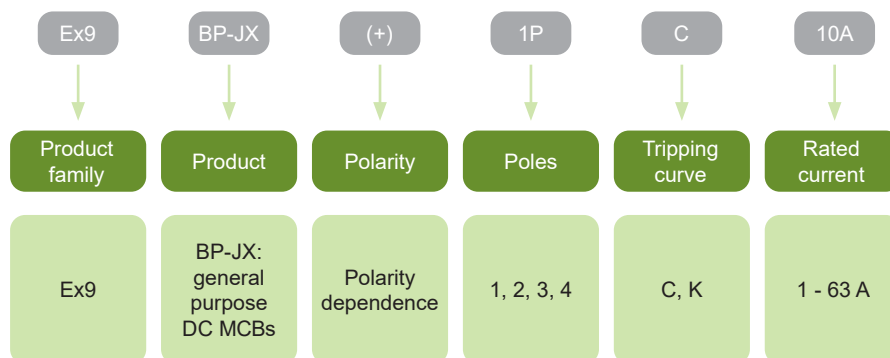

Certification marks



DC Miniature Circuit Breakers Ex9BP-JX

Accessories

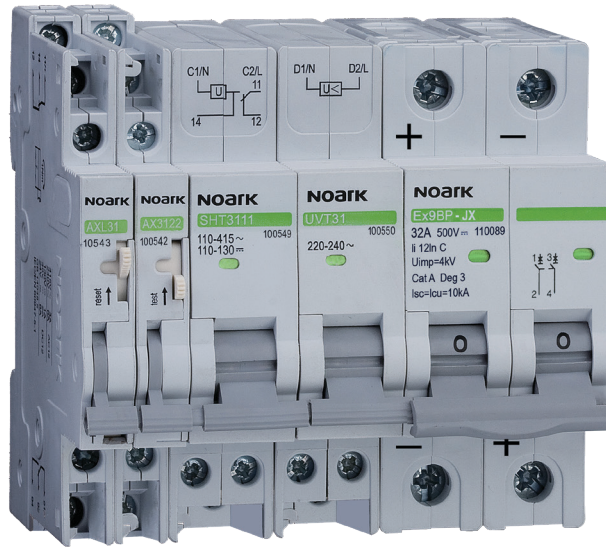

Auxiliary or signal contacts
AX, AL, AXL
Up to 3 units

Voltage or trip releases
SHT, UVT
Up to 2 units

Miniature Circuit Breaker
Ex9BP-JX
1, 2, 3, 4-module width

Auxiliary contacts AX3111, AX3122

see page 132

Alarm contact AL3111

see page 132

Auxiliary and alarm contact AXL31

see page 132

Shunt trip releases SHT31, SHT3111

see page 132

Undervoltage releases UVT31, UVT3101, UVT3110

see page 133

All accessories are mounted to the MCBs Ex9BP-JX from the left side and are identical for devices of the line Ex9B, Ex9PN and Ex9IP.

DC Miniature Circuit Breakers Ex9BP-JX

C-Characteristic, 1-pole, 250 V DC



Rated current	Width	Char.	Article No.	Type	Packing
1 A	1 MU	C	110067	Ex9BP-JX(+) 1P C1	1/12/144
2 A	1 MU	C	110068	Ex9BP-JX(+) 1P C2	1/12/144
3 A	1 MU	C	110069	Ex9BP-JX(+) 1P C3	1/12/144
4 A	1 MU	C	110070	Ex9BP-JX(+) 1P C4	1/12/144
6 A	1 MU	C	110071	Ex9BP-JX(+) 1P C6	1/12/144
10 A	1 MU	C	110072	Ex9BP-JX(+) 1P C10	1/12/144
16 A	1 MU	C	110073	Ex9BP-JX(+) 1P C16	1/12/144
20 A	1 MU	C	110074	Ex9BP-JX(+) 1P C20	1/12/144
25 A	1 MU	C	110075	Ex9BP-JX(+) 1P C25	1/12/144
32 A	1 MU	C	110076	Ex9BP-JX(+) 1P C32	1/12/144
40 A	1 MU	C	110077	Ex9BP-JX(+) 1P C40	1/12/144
50 A	1 MU	C	110078	Ex9BP-JX(+) 1P C50	1/12/144
63 A	1 MU	C	110079	Ex9BP-JX(+) 1P C63	1/12/144

C-Characteristic, 2-pole, 500 V DC



Rated current	Width	Char.	Article No.	Type	Packing
1 A	2 MU	C	110080	Ex9BP-JX(+) 2P C1	1/6/72
2 A	2 MU	C	110081	Ex9BP-JX(+) 2P C2	1/6/72
3 A	2 MU	C	110082	Ex9BP-JX(+) 2P C3	1/6/72
4 A	2 MU	C	110083	Ex9BP-JX(+) 2P C4	1/6/72
6 A	2 MU	C	110084	Ex9BP-JX(+) 2P C6	1/6/72
10 A	2 MU	C	110085	Ex9BP-JX(+) 2P C10	1/6/72
16 A	2 MU	C	110086	Ex9BP-JX(+) 2P C16	1/6/72
20 A	2 MU	C	110087	Ex9BP-JX(+) 2P C20	1/6/72
25 A	2 MU	C	110088	Ex9BP-JX(+) 2P C25	1/6/72
32 A	2 MU	C	110089	Ex9BP-JX(+) 2P C32	1/6/72
40 A	2 MU	C	110090	Ex9BP-JX(+) 2P C40	1/6/72
50 A	2 MU	C	110091	Ex9BP-JX(+) 2P C50	1/6/72
63 A	2 MU	C	110092	Ex9BP-JX(+) 2P C63	1/6/72

C-Characteristic, 3-pole, 750 V DC



Rated current	Width	Char.	Article No.	Type	Packing
1 A	3 MU	C	110093	Ex9BP-JX(+) 3P C1	1/4/48
2 A	3 MU	C	110094	Ex9BP-JX(+) 3P C2	1/4/48
3 A	3 MU	C	110095	Ex9BP-JX(+) 3P C3	1/4/48
4 A	3 MU	C	110096	Ex9BP-JX(+) 3P C4	1/4/48
6 A	3 MU	C	110097	Ex9BP-JX(+) 3P C6	1/4/48
10 A	3 MU	C	110098	Ex9BP-JX(+) 3P C10	1/4/48
16 A	3 MU	C	110099	Ex9BP-JX(+) 3P C16	1/4/48
20 A	3 MU	C	110100	Ex9BP-JX(+) 3P C20	1/4/48
25 A	3 MU	C	110101	Ex9BP-JX(+) 3P C25	1/4/48
32 A	3 MU	C	110102	Ex9BP-JX(+) 3P C32	1/4/48
40 A	3 MU	C	110103	Ex9BP-JX(+) 3P C40	1/4/48
50 A	3 MU	C	110104	Ex9BP-JX(+) 3P C50	1/4/48
63 A	3 MU	C	110105	Ex9BP-JX(+) 3P C63	1/4/48

DC Miniature Circuit Breakers Ex9BP-JX

C-Characteristic, 4-pole, 1000 V DC



Rated current	Width	Char.	Article No.	Type	Packing
1 A	4 MU	C	110106	Ex9BP-JX(+) 4P C1	1/3/36
2 A	4 MU	C	110107	Ex9BP-JX(+) 4P C2	1/3/36
3 A	4 MU	C	110108	Ex9BP-JX(+) 4P C3	1/3/36
4 A	4 MU	C	110109	Ex9BP-JX(+) 4P C4	1/3/36
6 A	4 MU	C	110110	Ex9BP-JX(+) 4P C6	1/3/36
10 A	4 MU	C	110111	Ex9BP-JX(+) 4P C10	1/3/36
16 A	4 MU	C	110112	Ex9BP-JX(+) 4P C16	1/3/36
20 A	4 MU	C	110113	Ex9BP-JX(+) 4P C20	1/3/36
25 A	4 MU	C	110114	Ex9BP-JX(+) 4P C25	1/3/36
32 A	4 MU	C	110115	Ex9BP-JX(+) 4P C32	1/3/36
40 A	4 MU	C	110116	Ex9BP-JX(+) 4P C40	1/3/36
50 A	4 MU	C	110117	Ex9BP-JX(+) 4P C50	1/3/36
63 A	4 MU	C	110118	Ex9BP-JX(+) 4P C63	1/3/36

DC Miniature Circuit Breakers Ex9BP-JX

K-Characteristic, 1-pole, 250 V DC



Rated current	Width	Char.	Article No.	Type	Packing
1 A	1 MU	K	110119	Ex9BP-JX(+) 1P K1	1/12/144
2 A	1 MU	K	110120	Ex9BP-JX(+) 1P K2	1/12/144
3 A	1 MU	K	110121	Ex9BP-JX(+) 1P K3	1/12/144
4 A	1 MU	K	110122	Ex9BP-JX(+) 1P K4	1/12/144
6 A	1 MU	K	110123	Ex9BP-JX(+) 1P K6	1/12/144
10 A	1 MU	K	110124	Ex9BP-JX(+) 1P K10	1/12/144
16 A	1 MU	K	110125	Ex9BP-JX(+) 1P K16	1/12/144
20 A	1 MU	K	110126	Ex9BP-JX(+) 1P K20	1/12/144
25 A	1 MU	K	110127	Ex9BP-JX(+) 1P K25	1/12/144
32 A	1 MU	K	110128	Ex9BP-JX(+) 1P K32	1/12/144
40 A	1 MU	K	110129	Ex9BP-JX(+) 1P K40	1/12/144
50 A	1 MU	K	110130	Ex9BP-JX(+) 1P K50	1/12/144
63 A	1 MU	K	110131	Ex9BP-JX(+) 1P K63	1/12/144

K-Characteristic, 2-pole, 500 V DC



Rated current	Width	Char.	Article No.	Type	Packing
1 A	2 MU	K	110132	Ex9BP-JX(+) 2P K1	1/6/72
2 A	2 MU	K	110133	Ex9BP-JX(+) 2P K2	1/6/72
3 A	2 MU	K	110134	Ex9BP-JX(+) 2P K3	1/6/72
4 A	2 MU	K	110135	Ex9BP-JX(+) 2P K4	1/6/72
6 A	2 MU	K	110136	Ex9BP-JX(+) 2P K6	1/6/72
10 A	2 MU	K	110137	Ex9BP-JX(+) 2P K10	1/6/72
16 A	2 MU	K	110138	Ex9BP-JX(+) 2P K16	1/6/72
20 A	2 MU	K	110139	Ex9BP-JX(+) 2P K20	1/6/72
25 A	2 MU	K	110140	Ex9BP-JX(+) 2P K25	1/6/72
32 A	2 MU	K	110141	Ex9BP-JX(+) 2P K32	1/6/72
40 A	2 MU	K	110142	Ex9BP-JX(+) 2P K40	1/6/72
50 A	2 MU	K	110143	Ex9BP-JX(+) 2P K50	1/6/72
63 A	2 MU	K	110144	Ex9BP-JX(+) 2P K63	1/6/72

K-Characteristic, 3-pole, 750 V DC



Rated current	Width	Char.	Article No.	Type	Packing
1 A	3 MU	K	110145	Ex9BP-JX(+) 3P K1	1/4/48
2 A	3 MU	K	110146	Ex9BP-JX(+) 3P K2	1/4/48
3 A	3 MU	K	110147	Ex9BP-JX(+) 3P K3	1/4/48
4 A	3 MU	K	110148	Ex9BP-JX(+) 3P K4	1/4/48
6 A	3 MU	K	110149	Ex9BP-JX(+) 3P K6	1/4/48
10 A	3 MU	K	110150	Ex9BP-JX(+) 3P K10	1/4/48
16 A	3 MU	K	110151	Ex9BP-JX(+) 3P K16	1/4/48
20 A	3 MU	K	110152	Ex9BP-JX(+) 3P K20	1/4/48
25 A	3 MU	K	110153	Ex9BP-JX(+) 3P K25	1/4/48
32 A	3 MU	K	110154	Ex9BP-JX(+) 3P K32	1/4/48
40 A	3 MU	K	110155	Ex9BP-JX(+) 3P K40	1/4/48
50 A	3 MU	K	110156	Ex9BP-JX(+) 3P K50	1/4/48
63 A	3 MU	K	110157	Ex9BP-JX(+) 3P K63	1/4/48

DC Miniature Circuit Breakers Ex9BP-JX

K-Characteristic, 4-pole, 1000 V DC



Rated current	Width	Char.	Article No.	Type	Packing
1 A	4 MU	K	110158	Ex9BP-JX(+) 4P K1	1/3/36
2 A	4 MU	K	110159	Ex9BP-JX(+) 4P K2	1/3/36
3 A	4 MU	K	110160	Ex9BP-JX(+) 4P K3	1/3/36
4 A	4 MU	K	110161	Ex9BP-JX(+) 4P K4	1/3/36
6 A	4 MU	K	110162	Ex9BP-JX(+) 4P K6	1/3/36
10 A	4 MU	K	110163	Ex9BP-JX(+) 4P K10	1/3/36
16 A	4 MU	K	110164	Ex9BP-JX(+) 4P K16	1/3/36
20 A	4 MU	K	110165	Ex9BP-JX(+) 4P K20	1/3/36
25 A	4 MU	K	110166	Ex9BP-JX(+) 4P K25	1/3/36
32 A	4 MU	K	110167	Ex9BP-JX(+) 4P K32	1/3/36
40 A	4 MU	K	110168	Ex9BP-JX(+) 4P K40	1/3/36
50 A	4 MU	K	110169	Ex9BP-JX(+) 4P K50	1/3/36
63 A	4 MU	K	110170	Ex9BP-JX(+) 4P K63	1/3/36

Fuse holders and disconnectors

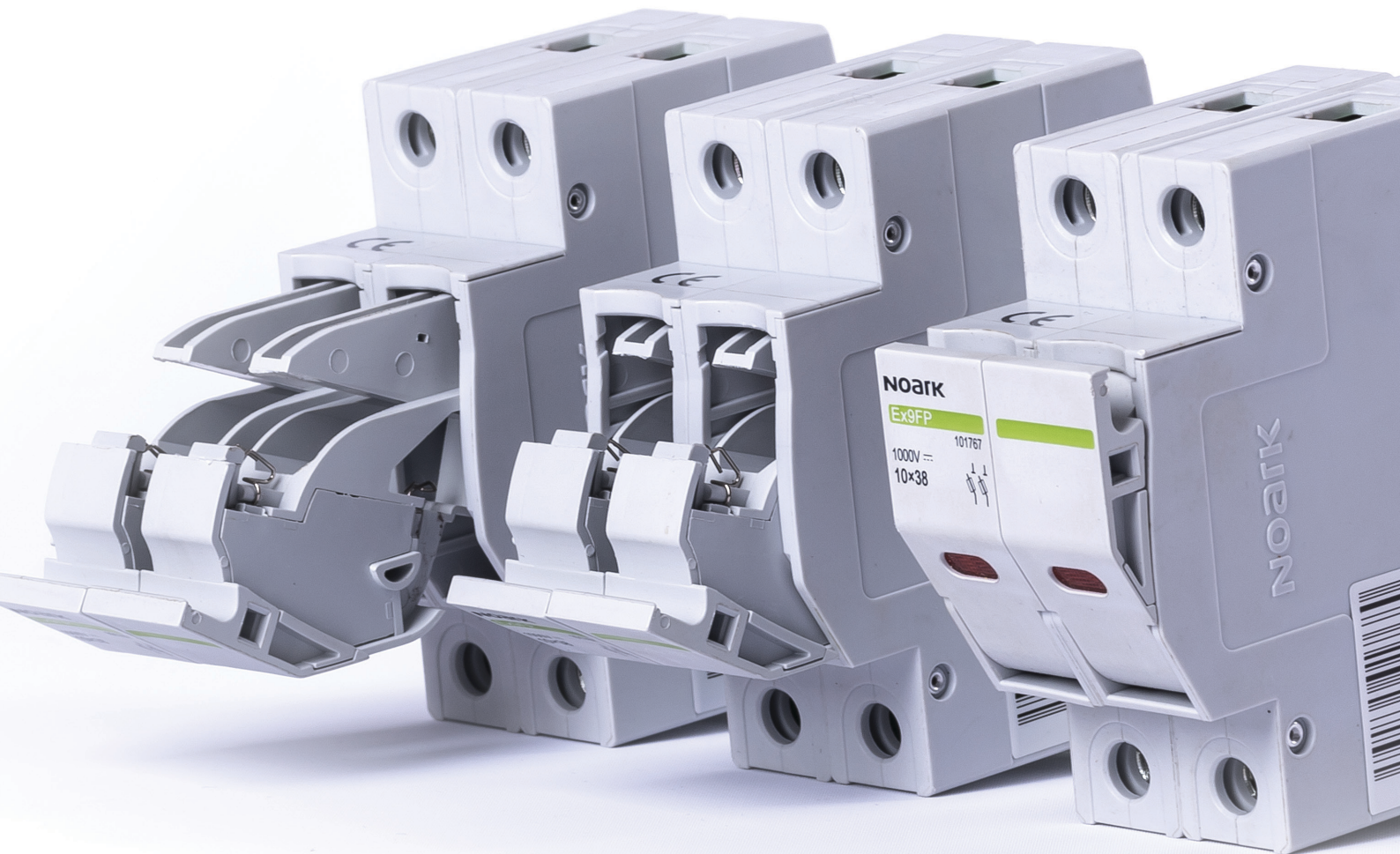

Fuse holders and disconnectors

Professional Tips

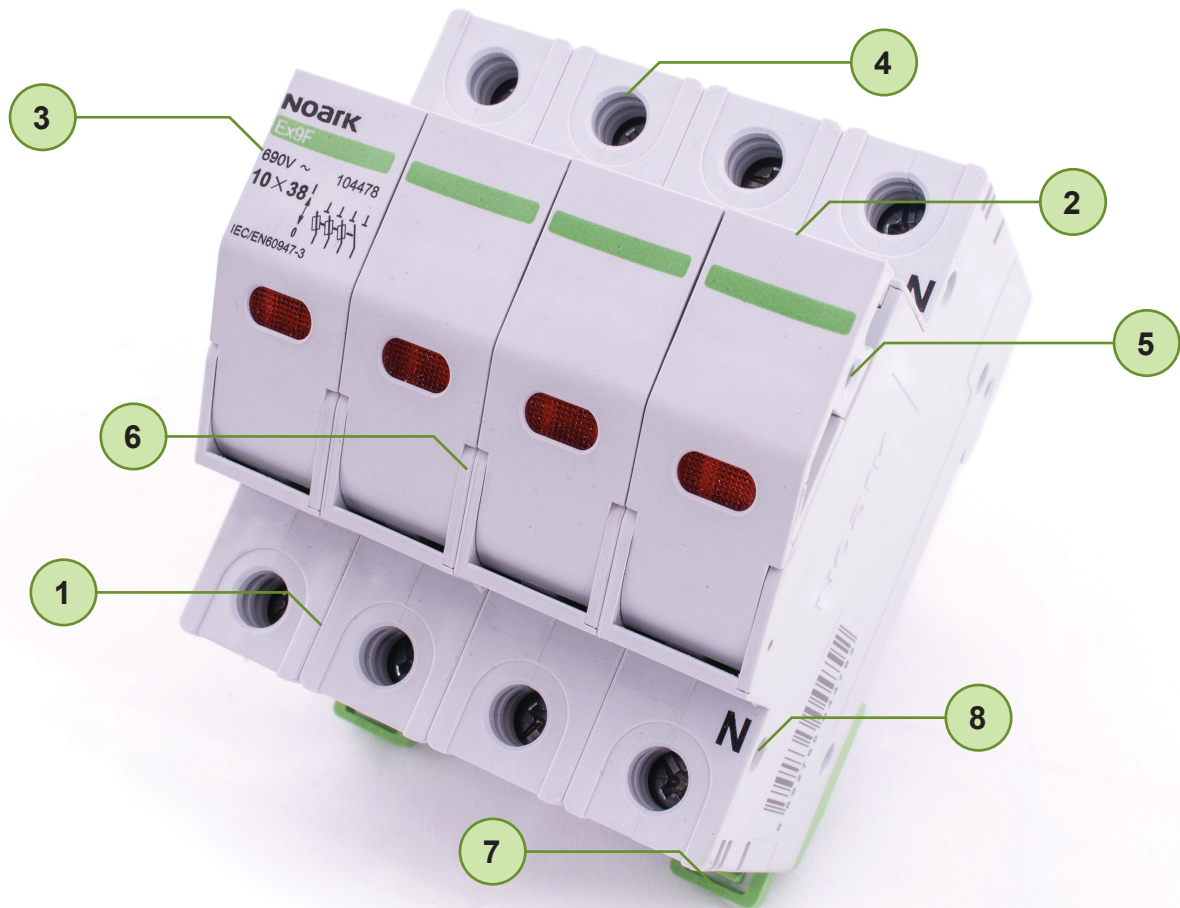

- 1 5 year warranty
- 2 Three type sizes of cylindrical fuse links
- 3 Rated currents up to 100 A
- 4 1-pole to 3+N-pole version
- 5 Sealing possibility
- 6 AC and DC variants available
- 7 Easy mounting on DIN rail
- 8 Undemountable and robust construction

Cylindrical Fuse Holders Ex9F



- Meet requirements of EN 60947-3
- Rated operating voltage 400/690 V AC
- Versions with rated current
 - 32 A (10 x 38 mm)
 - 50 A (14 x 51 mm)
 - 100 A (22 x 58 mm)
- Utilization category AC-20B at 400/690 V AC
- Sealing possibility

Cylindrical fuse holders for rated currents up to 100 A. Thanks to utilization category AC-20B at 400/690 V AC they cannot be used for switching under load. Very compact design with DIN rail mounting allows its usage in various applications. Fuse links of types gG and aM can be used with respect to maximum allowed power loss.

To be operated by qualified persons.

Type Key

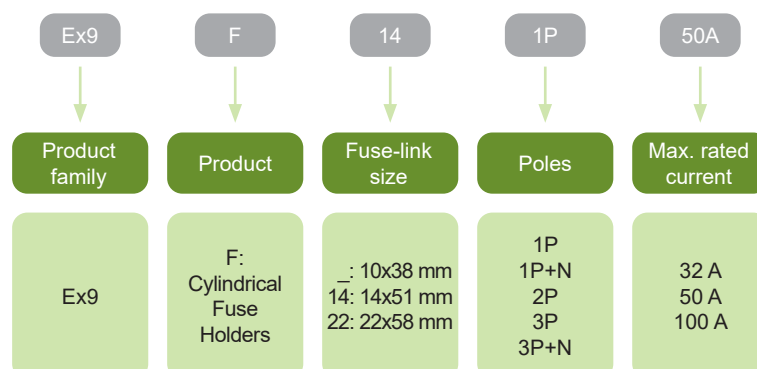

Certification marks



Cylindrical Fuse Holders Ex9F

Cylindrical Fuse Holders up to 32 A

- For cylindrical fuse-links of size 10 x 38 mm
- Rated operating voltage 400/690 V AC
- Utilization category AC-20B at 400/690 V AC
- Meets requirements of EN 60947-3, to be operated by qualified persons only
- With or without signalization status



Poles	Signalization	Article No.	Type	Packing
1P	yes	104474	Ex9F 1P 32A	1/12/144
1P+N	yes	104475	Ex9F 1PN 32A	1/6/72
2P	yes	104476	Ex9F 2P 32A	1/6/72
3P	yes	104477	Ex9F 3P 32A	1/4/48
3P+N	yes	104478	Ex9F 3PN 32A	1/3/36
1P	no	109054	Ex9F 1P 32A WI	1/12/144
1P+N	no	109055	Ex9F 1PN 32A WI	1/6/72
2P	no	109056	Ex9F 2P 32A WI	1/6/72
3P	no	109057	Ex9F 3P 32A WI	1/4/48
3P+N	no	109058	Ex9F 3PN 32A WI	1/3/36

Cylindrical Fuse Holders up to 50 A

- For cylindrical fuse-links of size 14 x 51 mm
- Rated operating voltage 400/690 V AC
- Utilization category AC-20B at 400/690 V AC
- Meets requirements of EN 60947-3, to be operated by qualified persons only



Poles	Signalization	Article No.	Type	Packing
1P	no	104479	Ex9F-14 1P 50A	1/12/144
1P+N	no	104480	Ex9F-14 1PN 50A	1/6/72
2P	no	104481	Ex9F-14 2P 50A	1/6/72
3P	no	104482	Ex9F-14 3P 50A	1/4/48
3P+N	no	104483	Ex9F-14 3PN 50A	1/3/36

Cylindrical Fuse Holders up to 100 A

- For cylindrical fuse-links of size 22 x 58 mm
- Rated operating voltage 400/690 V AC
- Utilization category AC-20B at 400/690 V AC
- Meets requirements of EN 60947-3, to be operated by qualified persons only



Poles	Signalization	Article No.	Type	Packing
1P	no	104484	Ex9F-22 1P 100A	1/9/108
1P+N	no	104485	Ex9F-22 1PN 100A	1/4/48
2P	no	104486	Ex9F-22 2P 100A	1/4/48
3P	no	104487	Ex9F-22 3P 100A	1/3/36
3P+N	no	104488	Ex9F-22 3PN 100A	1/2/24

DC fuse disconnectors Ex9FP



- DC fuse disconnectors
- Suitable for PV systems
- Rated short-circuit breaking capacity I_{cn} with appropriate fuse-link up to 33 kA
- Rated current up to 30 A
- Rated operational voltage 1000 V DC
- Optical tripping indicator
- Fuse-links of size 10 x 38 mm
- 1 and 2-pole variants
- Utilization category DC-20B

Fuse disconnectors Ex9FP for photovoltaic string protection against short circuit and overload. Suitable for cylindrical fuse-links of size 10 x 38 mm.

LED optical tripping indicator on the front side is signaling the fuse fault.

Type Key

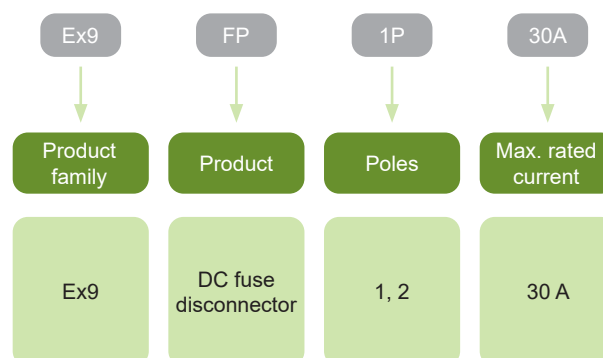

Certification marks



DC fuse disconnectors Ex9FP

1-pole



Poles	Article No.	Type	Packing
1	101766	Ex9FP 1P 30A	1/12/144

2-pole



Poles	Article No.	Type	Packing
2	101767	Ex9FP 2P 30A	1/6/72

Cylindrical Fuse Switch Disconnectors Ex9FS



- Meet requirements of EN 60947-3
- Rated operating voltage 400/500 V AC
- Versions with rated current
 - 32 A (10 x 38 mm)
 - 50 A (14 x 51 mm)
 - 100 A (22 x 58 mm)
- Utilization categories AC-21B at 500 V AC and AC-22B at 400 V AC
- Sealing possibility

Cylindrical fuse switch disconnectors for rated currents up to 100 A. Thanks to utilization categories AC-21B at 500 V AC and AC-22B at 400 V AC they can be used for switching under load. Very compact design with DIN rail mounting allows its usage in various applications. Fuse links of types gG and aM can be used with respect to maximum allowed power loss.

To be operated by qualified persons.

Type Key

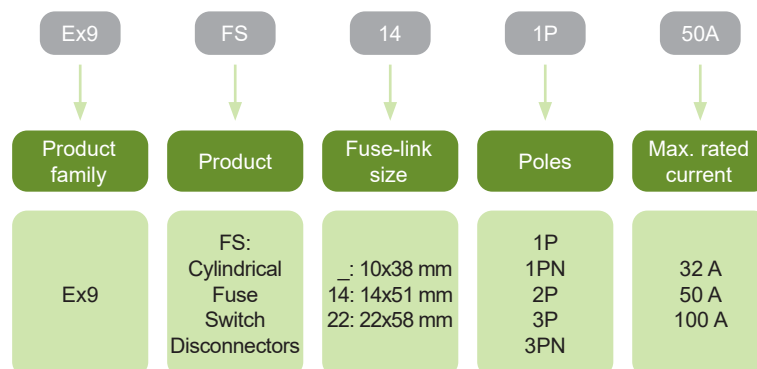

Certification marks



Cylindrical Fuse Switch Disconnectors Ex9FS

Cylindrical Fuse Switch Disconnectors up to 32 A

- For cylindrical fuse-links of size 10 x 38 mm
- Rated operating voltage 400/500 V AC
- Utilization categories AC-21B at 500 V AC and AC-22B at 400 V AC
- Meets requirements of EN 60947-3, to be operated by qualified persons only
- With signalization status



Poles	Signalization	Article No.	Type	Packing
1P	yes	109840	Ex9FS 1P 32A	1/12/144
1P+N	yes	109841	Ex9FS 1PN 32A	1/6/72
2P	yes	109842	Ex9FS 2P 32A	1/6/72
3P	yes	109843	Ex9FS 3P 32A	1/4/48
3P+N	yes	109844	Ex9FS 3PN 32A	1/3/36

Cylindrical Fuse Switch Disconnectors up to 50 A

- For cylindrical fuse-links of size 14 x 51 mm
- Rated operating voltage 400/500 V AC
- Utilization categories AC-21B at 500 V AC and AC-22B at 400 V AC
- Meets requirements of EN 60947-3, to be operated by qualified persons only



Poles	Signalization	Article No.	Type	Packing
1P	no	109845	Ex9FS-14 1P 50A	1/12/144
1P+N	no	109846	Ex9FS-14 1PN 50A	1/6/72
2P	no	109847	Ex9FS-14 2P 50A	1/6/72
3P	no	109848	Ex9FS-14 3P 50A	1/4/48
3P+N	no	109849	Ex9FS-14 3PN 50A	1/3/36

Cylindrical Fuse Switch Disconnectors up to 100 A

- For cylindrical fuse-links of size 22 x 58 mm
- Rated operating voltage 400/500 V AC
- Utilization categories AC-21B at 500 V AC and AC-22B at 400 V AC
- Meets requirements of EN 60947-3, to be operated by qualified persons only



Poles	Signalization	Article No.	Type	Packing
1P	no	109850	Ex9FS-22 1P 100A	1/9/108
1P+N	no	109851	Ex9FS-22 1PN 100A	1/4/48
2P	no	109852	Ex9FS-22 2P 100A	1/4/48
3P	no	109853	Ex9FS-22 3P 100A	1/3/36
3P+N	no	109854	Ex9FS-22 3PN 100A	1/2/24

Isolators



Isolators

Professional Tips

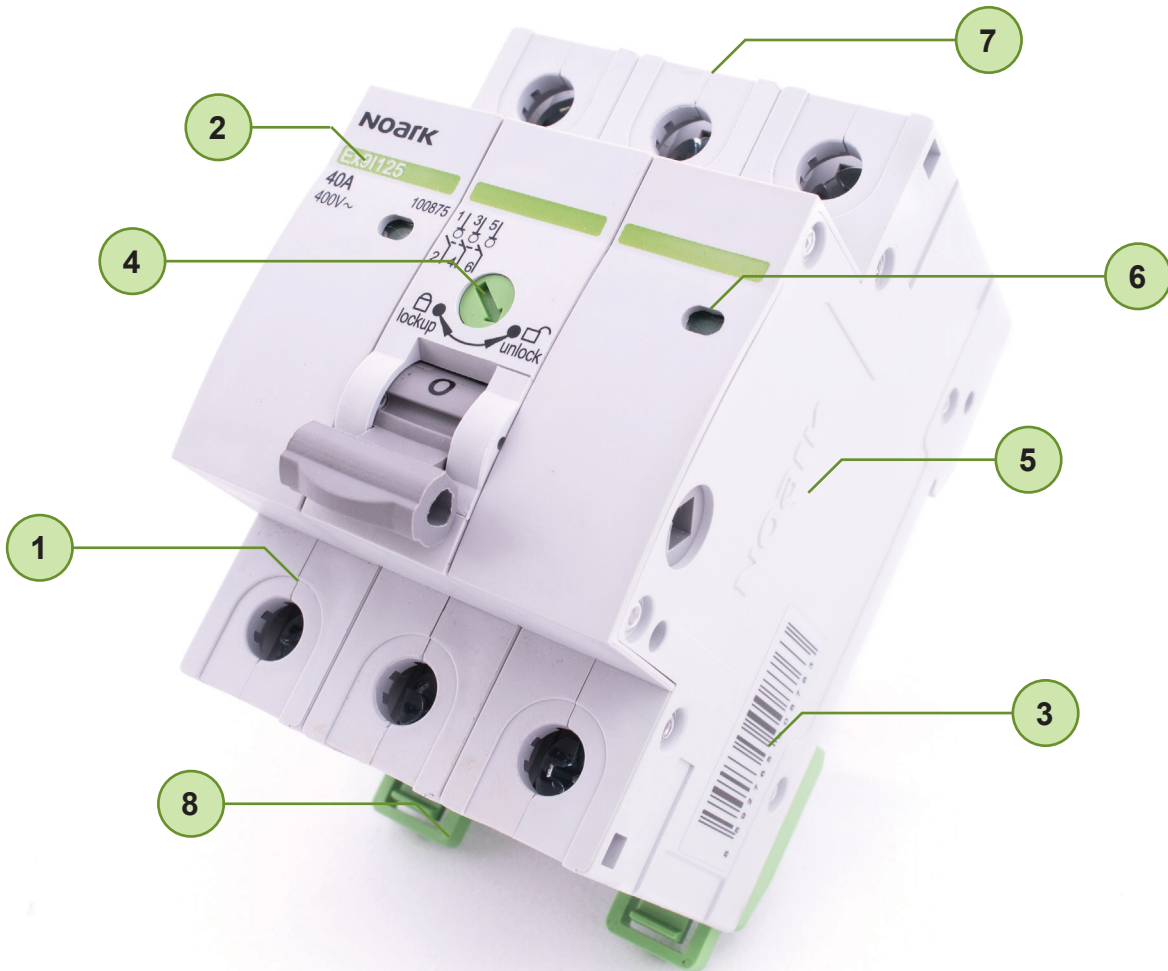

- | | | | |
|---|--------------------------------------|---|--|
| 1 | 5 year warranty | 5 | Ex9BI line compatible with accessories |
| 2 | Rated current up to 125 A | 6 | Contact state indication |
| 3 | Compact 4-pole variant Ex9I40 in 1MU | 7 | Possibility to use interconnection busbars |
| 4 | Toggle OFF position lock | 8 | Easy mounting on DIN rail |

Isolators Ex9I125



- Modular Isolators
- Rated current up to 125 A
- Rated voltage 230 / 400 V AC
- Rated short-time withstand current $I_{cw} = 12 \times I_e, 1 \text{ s}$
- Meet requirements of IEC / EN 60947-3
- Built-in lock mechanism for OFF position
- 1 up to 4-pole version

Isolators Ex9I125 can be used as a main switch in wide variety of applications. These switches are tested according to IEC / EN 60947-3 standards and also fulfill the requirements for the isolation functionality.

Utilization category AC-22A ensures possibility of switching mixed resistive and inductive loads with low overloads with $\cos \varphi = 0.65$. Subcategory A allows frequent operation.

Isolators of line Ex9I125 are produced in modular design with one module unit width per pole. Can be connected via standard busbars of both fork as well as pin type of connection.

Type Key

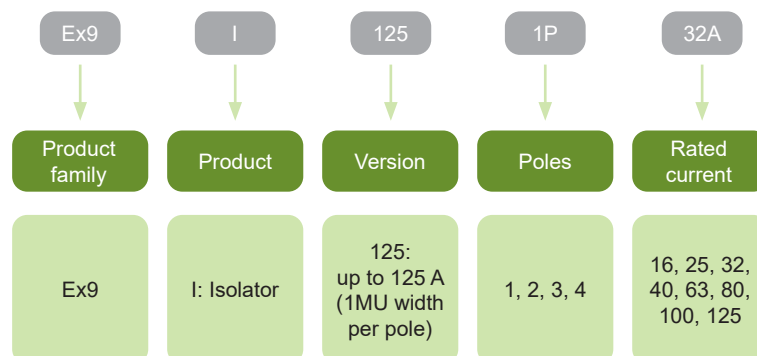

Certification marks



Isolators Ex91125

1-pole



Rated current	Poles	Width	Article No.	Type	Packing
16 A	1	1 MU	102304	Ex91125 1P 16A	1/12/144
25 A	1	1 MU	102305	Ex91125 1P 25A	1/12/144
32 A	1	1 MU	100862	Ex91125 1P 32A	1/12/144
40 A	1	1 MU	100863	Ex91125 1P 40A	1/12/144
63 A	1	1 MU	100864	Ex91125 1P 63A	1/12/144
80 A	1	1 MU	100865	Ex91125 1P 80A	1/12/144
100 A	1	1 MU	100866	Ex91125 1P 100A	1/12/144
125 A	1	1 MU	100867	Ex91125 1P 125A	1/12/144

2-pole



Rated current	Poles	Width	Article No.	Type	Packing
16 A	2	2 MU	102306	Ex91125 2P 16A	1/6/72
25 A	2	2 MU	102307	Ex91125 2P 25A	1/6/72
32 A	2	2 MU	100868	Ex91125 2P 32A	1/6/72
40 A	2	2 MU	100869	Ex91125 2P 40A	1/6/72
63 A	2	2 MU	100870	Ex91125 2P 63A	1/6/72
80 A	2	2 MU	100871	Ex91125 2P 80A	1/6/72
100 A	2	2 MU	100872	Ex91125 2P 100A	1/6/72
125 A	2	2 MU	100873	Ex91125 2P 125A	1/6/72

3-pole



Rated current	Poles	Width	Article No.	Type	Packing
16 A	3	3 MU	102308	Ex91125 3P 16A	1/4/48
25 A	3	3 MU	102309	Ex91125 3P 25A	1/4/48
32 A	3	3 MU	100874	Ex91125 3P 32A	1/4/48
40 A	3	3 MU	100875	Ex91125 3P 40A	1/4/48
63 A	3	3 MU	100876	Ex91125 3P 63A	1/4/48
80 A	3	3 MU	100877	Ex91125 3P 80A	1/4/48
100 A	3	3 MU	100878	Ex91125 3P 100A	1/4/48
125 A	3	3 MU	100879	Ex91125 3P 125A	1/4/48

4-pole



Rated current	Poles	Width	Article No.	Type	Packing
16 A	4	4 MU	102310	Ex91125 4P 16A	1/3/36
25 A	4	4 MU	102311	Ex91125 4P 25A	1/3/36
32 A	4	4 MU	100880	Ex91125 4P 32A	1/3/36
40 A	4	4 MU	100881	Ex91125 4P 40A	1/3/36
63 A	4	4 MU	100882	Ex91125 4P 63A	1/3/36
80 A	4	4 MU	100883	Ex91125 4P 80A	1/3/36
100 A	4	4 MU	100884	Ex91125 4P 100A	1/3/36
125 A	4	4 MU	100885	Ex91125 4P 125A	1/3/36

Isolators Ex9I40



- Modular Isolators
- Rated current up to 40 A
- Width 1 MU up to 4-pole version
- Rated voltage 230 / 400 V AC
- Rated short-time withstand current $I_{cw} = 12 \times I_e, 1 \text{ s}$
- Meet requirements of IEC / EN 60947-3
- Built-in lock mechanism for OFF position
- 1 up to 4-pole version

Isolators Ex9I40 can be used as a main switch in wide variety of applications. These switches are tested according to IEC / EN 60947-3 standards and also fulfill the requirements for the isolation functionality.

Utilization category AC-22A ensures possibility of switching mixed resistive and inductive loads with low overloads with $\cos \varphi = 0.65$. Subcategory A allows frequent operation.

Isolators of line Ex9I40 are produced in modular design with width one module unit for all versions up to 4-pole. It brings very low consumption of space in an installation.

Type Key

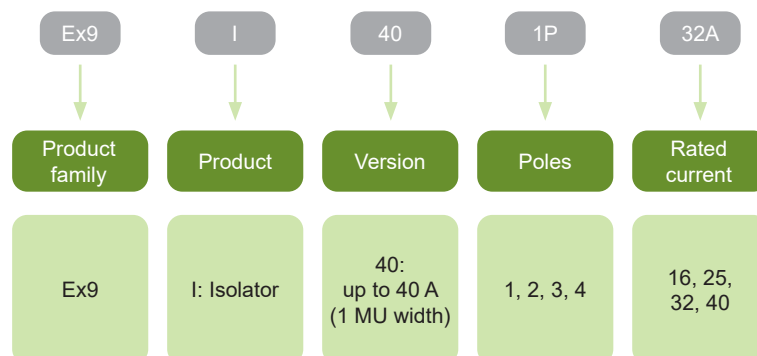

Certification marks



Isolators Ex9I40

1-pole



Rated current	Poles	Width	Article No.	Type	Packing
16 A	1	1 MU	102296	Ex9I40 1P 16A	1/12/144
25 A	1	1 MU	102297	Ex9I40 1P 25A	1/12/144
32 A	1	1 MU	101387	Ex9I40 1P 32A	1/12/144
40 A	1	1 MU	101388	Ex9I40 1P 40A	1/12/144

2-pole



Rated current	Poles	Width	Article No.	Type	Packing
16 A	2	1 MU	102298	Ex9I40 2P 16A	1/12/144
25 A	2	1 MU	102299	Ex9I40 2P 25A	1/12/144
32 A	2	1 MU	101389	Ex9I40 2P 32A	1/12/144
40 A	2	1 MU	101390	Ex9I40 2P 40A	1/12/144

3-pole



Rated current	Poles	Width	Article No.	Type	Packing
16 A	3	1 MU	102300	Ex9I40 3P 16A	1/12/144
25 A	3	1 MU	102301	Ex9I40 3P 25A	1/12/144
32 A	3	1 MU	101391	Ex9I40 3P 32A	1/12/144
40 A	3	1 MU	101392	Ex9I40 3P 40A	1/12/144

4-pole



Rated current	Poles	Width	Article No.	Type	Packing
16 A	4	1 MU	102302	Ex9I40 4P 16A	1/12/144
25 A	4	1 MU	102303	Ex9I40 4P 25A	1/12/144
32 A	4	1 MU	101393	Ex9I40 4P 32A	1/12/144
40 A	4	1 MU	101394	Ex9I40 4P 40A	1/12/144

Isolators Ex9BI



- Modular Isolators with accessories
- Rated current up to 63 A
- Rated voltage 230/400 V AC
- Rated short-time withstand current $I_{cw} = 1 \text{ kA}, 1 \text{ s}$
- Meet requirements of IEC / EN 60947-3
- 1 up to 4-pole version
- Wide range of accessories

Isolators Ex9BI can be used as a main switch in wide variety of applications. These switches are tested according to IEC/EN 60947-3 standards and also fulfill the requirements for the isolation functionality.

Utilization category AC-22A ensures possibility of switching mixed resistive and inductive loads with low overloads with $\cos \varphi = 0.65$. Subcategory A allows frequent operation.

Isolators of line Ex9BI are produced in modular design with width one module unit per pole. Can be connected via standard busbars of both fork as well as pin type of connection.

Ex9BI Isolators can be also combined with wide range of accessories including auxiliary contacts, shunt trip releases, undervoltage and overvoltage releases. It is possible to create diversified combination of accessories.

Type Key

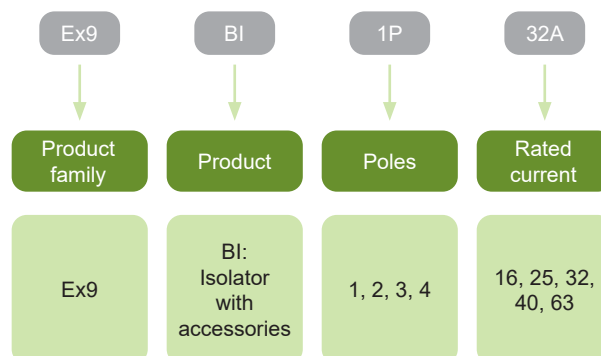

Certification marks



Isolators Ex9BI

Accessories



Auxiliary contacts
AX
Up to 3 units

Voltage or trip releases
SHT, UVT, OVT
Up to 2 units

Isolator
Ex9BI
1, 2, 3, 4-pole

Auxiliary contacts AX3111, AX3122

see page 132

Shunt trip releases SHT31, SHT3111

see page 132

Undervoltage releases UVT31, UVT3101, UVT3110

see page 132

Overvoltage release OVT31

see page 132

All accessories are mounted to the isolators Ex9BI from the left side and are identical for devices of the line Ex9B, Ex9PN and Ex9IP.

Isolators Ex9BI

1-pole



Rated current	Poles	Width	Article No.	Type	Packing
16 A	1	1 MU	102378	Ex9BI 1P 16A	1/12/144
25 A	1	1 MU	102379	Ex9BI 1P 25A	1/12/144
32 A	1	1 MU	102380	Ex9BI 1P 32A	1/12/144
40 A	1	1 MU	102381	Ex9BI 1P 40A	1/12/144
63 A	1	1 MU	102382	Ex9BI 1P 63A	1/12/144

2-pole



Rated current	Poles	Width	Article No.	Type	Packing
16 A	2	2 MU	102383	Ex9BI 2P 16A	1/6/72
25 A	2	2 MU	102384	Ex9BI 2P 25A	1/6/72
32 A	2	2 MU	102385	Ex9BI 2P 32A	1/6/72
40 A	2	2 MU	102386	Ex9BI 2P 40A	1/6/72
63 A	2	2 MU	102387	Ex9BI 2P 63A	1/6/72

3-pole



Rated current	Poles	Width	Article No.	Type	Packing
16 A	3	3 MU	102388	Ex9BI 3P 16A	1/4/48
25 A	3	3 MU	102389	Ex9BI 3P 25A	1/4/48
32 A	3	3 MU	102390	Ex9BI 3P 32A	1/4/48
40 A	3	3 MU	102391	Ex9BI 3P 40A	1/4/48
63 A	3	3 MU	102392	Ex9BI 3P 63A	1/4/48

4-pole



Rated current	Poles	Width	Article No.	Type	Packing
16 A	4	4 MU	102393	Ex9BI 4P 16A	1/3/36
25 A	4	4 MU	102394	Ex9BI 4P 25A	1/3/36
32 A	4	4 MU	102395	Ex9BI 4P 32A	1/3/36
40 A	4	4 MU	102396	Ex9BI 4P 40A	1/3/36
63 A	4	4 MU	102397	Ex9BI 4P 63A	1/3/36

Notes

A large grid of dashed lines for taking notes, covering most of the page area.

Residual Current Devices



Residual Current Devices

Professional Tips

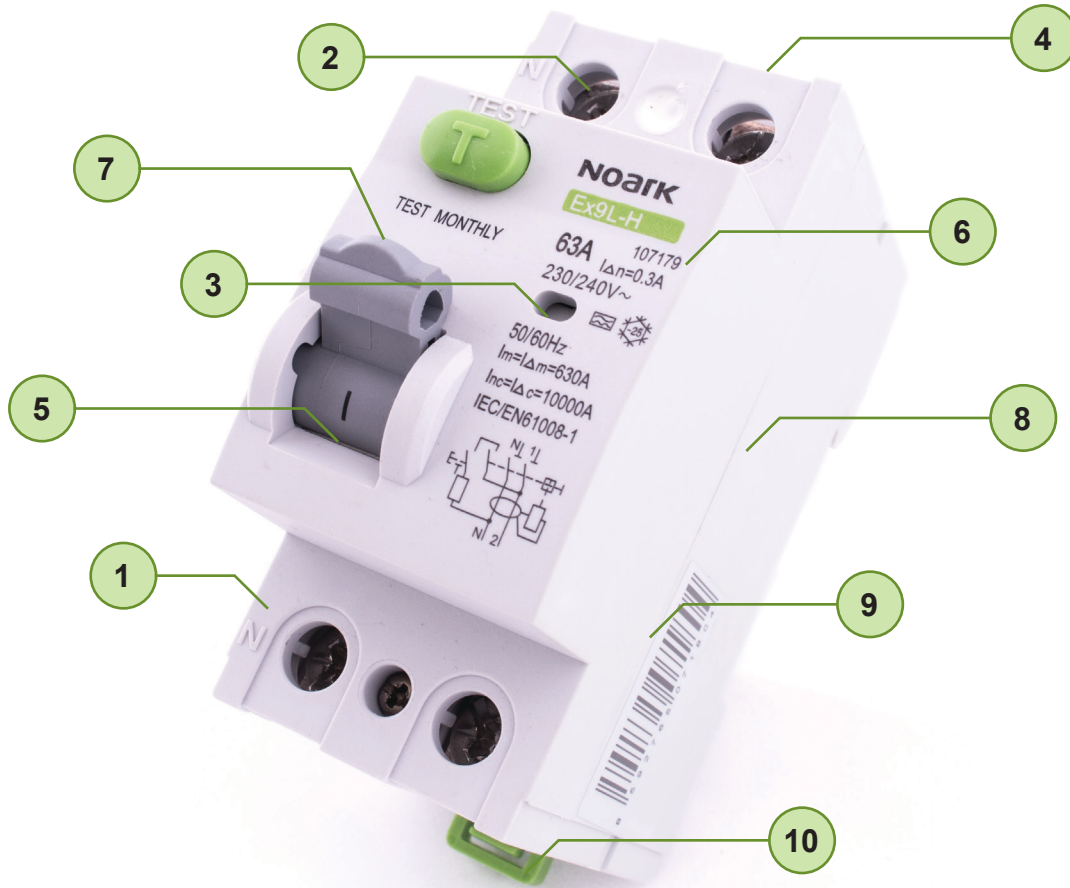

- 1 5 year warranty
- 2 Variants from 10 to 500 mA $I_{\Delta n}$ available
- 3 Contacts state indication
- 4 Possibility to use interconnection busbars
- 5 Prepared openings for toggle sealing
- 6 Tripping chars B, C of MCB in Ex9BL, Ex9NLE and Ex9NL-N
- 7 Splited RCCB / MCB toggles in Ex9BL
- 8 Wide range of accessories for Ex9BL, Ex9NLE and Ex9NL-N
- 9 Robust construction
- 10 Easy mounting on DIN rail

RCCBs Ex9L-H, 10 kA



- Residual Current Circuit Breakers according to EN 61008-1
- Cond. rated short circuit strength I_{nc} 10 kA
- 2 and 4-pole versions
- Rated residual current 10, 30, 100, 300 and 500 mA
- Rated current up to 63 A
- Rated operational voltage 230/400 V AC
- AC, A, S and G types
- Indication of electrical tripping
- Suitable for applications from -25 to +60 °C

Ex9L-H residual current circuit breakers are suitable for domestic as well as industrial applications. They are based on permanent magnet principle. It brings the advantage of voltage independent function. Adequate voltage is only necessary when testing the RCCB with the test button. Magnetic RCCBs should be tested regularly with a period of one month.

Type Key

Ex9	L	-H	2P	63 A	A	30mA	S
↓	↓	↓	↓	↓	↓	↓	↓
Product family	Product	Conditional short circuit strength	Poles	Rated current	Sensitivity to type of current	Rated residual current	Time delay (insensitivity)
Ex9	L: RCCB	-H : 10 kA	2P 4P	16 A 25 A 40 A 63 A	_ : AC A: A	10 mA 30 mA 100 mA 300 mA 500 mA	_ : 0 ms G : 10-300 ms S : 40-500 ms

Certification marks



RCCBs Ex9L-H, 10 kA

AC type, 2-pole

- AC type of residual current circuit breaker sensitive on residual AC current
- Without time delay
- Surge current-proof 3000 A
- 30 mA version suitable for protection of people in case of direct and indirect contact with live parts and exposed conductive parts during a fault, respectively
- Selective with upstream installed S or S+A type RCCB



Rated current	Rated residual current	Poles	Article No.	Type	Packing
16 A	10 mA	2	108156	Ex9L-H 2P 16A 10mA	1/81
25 A	10 mA	2	108157	Ex9L-H 2P 25A 10mA	1/81
16 A	30 mA	2	108158	Ex9L-H 2P 16A 30mA	1/81
25 A	30 mA	2	108159	Ex9L-H 2P 25A 30mA	1/81
40 A	30 mA	2	108160	Ex9L-H 2P 40A 30mA	1/81
63 A	30 mA	2	108161	Ex9L-H 2P 63A 30mA	1/81
16 A	100 mA	2	108162	Ex9L-H 2P 16A 100mA	1/81
25 A	100 mA	2	108163	Ex9L-H 2P 25A 100mA	1/81
40 A	100 mA	2	108164	Ex9L-H 2P 40A 100mA	1/81
63 A	100 mA	2	108165	Ex9L-H 2P 63A 100mA	1/81
16 A	300 mA	2	108166	Ex9L-H 2P 16A 300mA	1/81
25 A	300 mA	2	108167	Ex9L-H 2P 25A 300mA	1/81
40 A	300 mA	2	108168	Ex9L-H 2P 40A 300mA	1/81
63 A	300 mA	2	108169	Ex9L-H 2P 63A 300mA	1/81
16 A	500 mA	2	108170	Ex9L-H 2P 16A 500mA	1/81
25 A	500 mA	2	108171	Ex9L-H 2P 25A 500mA	1/81
40 A	500 mA	2	108172	Ex9L-H 2P 40A 500mA	1/81
63 A	500 mA	2	108173	Ex9L-H 2P 63A 500mA	1/81

AC type, 4-pole



Rated current	Rated residual current	Poles	Article No.	Type	Packing
16 A	30 mA	4	108174	Ex9L-H 4P 16A 30mA	1/45
25 A	30 mA	4	108175	Ex9L-H 4P 25A 30mA	1/45
40 A	30 mA	4	108176	Ex9L-H 4P 40A 30mA	1/45
63 A	30 mA	4	108177	Ex9L-H 4P 63A 30mA	1/45
16 A	100 mA	4	108178	Ex9L-H 4P 16A 100mA	1/45
25 A	100 mA	4	108179	Ex9L-H 4P 25A 100mA	1/45
40 A	100 mA	4	108180	Ex9L-H 4P 40A 100mA	1/45
63 A	100 mA	4	108181	Ex9L-H 4P 63A 100mA	1/45
16 A	300 mA	4	108182	Ex9L-H 4P 16A 300mA	1/45
25 A	300 mA	4	108183	Ex9L-H 4P 25A 300mA	1/45
40 A	300 mA	4	108184	Ex9L-H 4P 40A 300mA	1/45
63 A	300 mA	4	108185	Ex9L-H 4P 63A 300mA	1/45
16 A	500 mA	4	108186	Ex9L-H 4P 16A 500mA	1/45
25 A	500 mA	4	108187	Ex9L-H 4P 25A 500mA	1/45
40 A	500 mA	4	108188	Ex9L-H 4P 40A 500mA	1/45
63 A	500 mA	4	108189	Ex9L-H 4P 63A 500mA	1/45

RCCBs Ex9L-H, 10 kA

A type, 2-pole

- A type of residual current circuit breaker sensitive on residual AC and pulsating DC current
- Without time delay
- Surge current-proof 3000 A
- 30 mA version suitable for protection of people in case of direct and indirect contact with live parts and exposed conductive parts during a fault, respectively
- Selective with upstream installed S or S+A type RCCB



Rated current	Rated residual current	Poles	Article No.	Type	Packing
16 A	10 mA	2	108190	Ex9L-H 2P 16A A 10mA	1/81
25 A	10 mA	2	108191	Ex9L-H 2P 25A A 10mA	1/81
16 A	30 mA	2	108192	Ex9L-H 2P 16A A 30mA	1/81
25 A	30 mA	2	108193	Ex9L-H 2P 25A A 30mA	1/81
40 A	30 mA	2	108194	Ex9L-H 2P 40A A 30mA	1/81
63 A	30 mA	2	108195	Ex9L-H 2P 63A A 30mA	1/81
16 A	100 mA	2	108196	Ex9L-H 2P 16A A 100mA	1/81
25 A	100 mA	2	108197	Ex9L-H 2P 25A A 100mA	1/81
40 A	100 mA	2	108198	Ex9L-H 2P 40A A 100mA	1/81
63 A	100 mA	2	108199	Ex9L-H 2P 63A A 100mA	1/81
16 A	300 mA	2	108200	Ex9L-H 2P 16A A 300mA	1/81
25 A	300 mA	2	108201	Ex9L-H 2P 25A A 300mA	1/81
40 A	300 mA	2	108202	Ex9L-H 2P 40A A 300mA	1/81
63 A	300 mA	2	108203	Ex9L-H 2P 63A A 300mA	1/81

A type, 4-pole



Rated current	Rated residual current	Poles	Article No.	Type	Packing
16 A	30 mA	4	108204	Ex9L-H 4P 16A A 30mA	1/45
25 A	30 mA	4	108205	Ex9L-H 4P 25A A 30mA	1/45
40 A	30 mA	4	108206	Ex9L-H 4P 40A A 30mA	1/45
63 A	30 mA	4	108207	Ex9L-H 4P 63A A 30mA	1/45
16 A	100 mA	4	108208	Ex9L-H 4P 16A A 100mA	1/45
25 A	100 mA	4	108209	Ex9L-H 4P 25A A 100mA	1/45
40 A	100 mA	4	108210	Ex9L-H 4P 40A A 100mA	1/45
63 A	100 mA	4	108211	Ex9L-H 4P 63A A 100mA	1/45
16 A	300 mA	4	108212	Ex9L-H 4P 16A A 300mA	1/45
25 A	300 mA	4	108213	Ex9L-H 4P 25A A 300mA	1/45
40 A	300 mA	4	108214	Ex9L-H 4P 40A A 300mA	1/45
63 A	300 mA	4	108215	Ex9L-H 4P 63A A 300mA	1/45

RCCBs Ex9L-H, 10 kA

G type, 2-pole

- G type of residual current circuit breaker based on AC type sensitive on residual AC current
- High reliability against unwanted tripping
- Compulsory for any circuit where personal injury or damage to property may occur in case of unwanted tripping
- With time delay (insensitivity) 10 - 300 ms
- Surge current-proof 3000 A
- 30 mA version suitable for protection of people in case of direct and indirect contact with live parts and exposed conductive parts during a fault, respectively



Rated current	Rated residual current	Poles	Article No.	Type	Packing
16 A	30 mA	2	108256	Ex9L-H 2P 16A 30mA G	1/81
25 A	30 mA	2	108257	Ex9L-H 2P 25A 30mA G	1/81
40 A	30 mA	2	108258	Ex9L-H 2P 40A 30mA G	1/81
63 A	30 mA	2	108260	Ex9L-H 2P 63A 30mA G	1/81
16 A	100 mA	2	108259	Ex9L-H 2P 16A 100mA G	1/81
25 A	100 mA	2	108261	Ex9L-H 2P 25A 100mA G	1/81
40 A	100 mA	2	108262	Ex9L-H 2P 40A 100mA G	1/81
63 A	100 mA	2	108263	Ex9L-H 2P 63A 100mA G	1/81
16 A	300 mA	2	108264	Ex9L-H 2P 16A 300mA G	1/81
25 A	300 mA	2	108265	Ex9L-H 2P 25A 300mA G	1/81
40 A	300 mA	2	108266	Ex9L-H 2P 40A 300mA G	1/81
63 A	300 mA	2	108267	Ex9L-H 2P 63A 300mA G	1/81
16 A	500 mA	2	108268	Ex9L-H 2P 16A 500mA G	1/81
25 A	500 mA	2	108269	Ex9L-H 2P 25A 500mA G	1/81
40 A	500 mA	2	108270	Ex9L-H 2P 40A 500mA G	1/81
63 A	500 mA	2	108271	Ex9L-H 2P 63A 500mA G	1/81

G type, 4-pole



Rated current	Rated residual current	Poles	Article No.	Type	Packing
16 A	30 mA	4	108272	Ex9L-H 4P 16A 30mA G	1/45
25 A	30 mA	4	108273	Ex9L-H 4P 25A 30mA G	1/45
40 A	30 mA	4	108274	Ex9L-H 4P 40A 30mA G	1/45
63 A	30 mA	4	108275	Ex9L-H 4P 63A 30mA G	1/45
16 A	100 mA	4	108276	Ex9L-H 4P 16A 100mA G	1/45
25 A	100 mA	4	108277	Ex9L-H 4P 25A 100mA G	1/45
40 A	100 mA	4	108278	Ex9L-H 4P 40A 100mA G	1/45
63 A	100 mA	4	108279	Ex9L-H 4P 63A 100mA G	1/45
16 A	300 mA	4	108280	Ex9L-H 4P 16A 300mA G	1/45
25 A	300 mA	4	108281	Ex9L-H 4P 25A 300mA G	1/45
40 A	300 mA	4	108282	Ex9L-H 4P 40A 300mA G	1/45
63 A	300 mA	4	108283	Ex9L-H 4P 63A 300mA G	1/45
16 A	500 mA	4	108284	Ex9L-H 4P 16A 500mA G	1/45
25 A	500 mA	4	108285	Ex9L-H 4P 25A 500mA G	1/45
40 A	500 mA	4	108286	Ex9L-H 4P 40A 500mA G	1/45
63 A	500 mA	4	108287	Ex9L-H 4P 63A 500mA G	1/45

RCCBs Ex9L-H, 10 kA

G+A type, 4-pole

- G type of residual current circuit breaker based on A type sensitive on residual AC and pulsating DC current
- High reliability against unwanted tripping
- Compulsory for any circuit where personal injury or damage to property may occur in case of unwanted tripping
- With time delay (insensitivity) 10 - 300 ms
- Surge current-proof 3000 A
- 30 mA version suitable for protection of people in case of direct and indirect contact with live parts and exposed conductive parts during a fault, respectively



Rated current	Rated residual current	Poles	Article No.	Type	Packing
16 A	30 mA	2	108288	Ex9L-H 2P 16A A 30mA G	1/81
25 A	30 mA	2	108289	Ex9L-H 2P 25A A 30mA G	1/81
40 A	30 mA	2	108290	Ex9L-H 2P 40A A 30mA G	1/81
63 A	30 mA	2	108291	Ex9L-H 2P 63A A 30mA G	1/81
16 A	100 mA	2	108292	Ex9L-H 2P 16A A 100mA G	1/81
25 A	100 mA	2	108293	Ex9L-H 2P 25A A 100mA G	1/81
40 A	100 mA	2	108294	Ex9L-H 2P 40A A 100mA G	1/81
63 A	100 mA	2	108295	Ex9L-H 2P 63A A 100mA G	1/81
16 A	300 mA	2	108296	Ex9L-H 2P 16A A 300mA G	1/81
25 A	300 mA	2	108297	Ex9L-H 2P 25A A 300mA G	1/81
40 A	300 mA	2	108298	Ex9L-H 2P 40A A 300mA G	1/81
63 A	300 mA	2	108299	Ex9L-H 2P 63A A 300mA G	1/81

G+A type, 4-pole



Rated current	Rated residual current	Poles	Article No.	Type	Packing
16 A	30 mA	4	108300	Ex9L-H 4P 16A A 30mA G	1/45
25 A	30 mA	4	108301	Ex9L-H 4P 25A A 30mA G	1/45
40 A	30 mA	4	108302	Ex9L-H 4P 40A A 30mA G	1/45
63 A	30 mA	4	108303	Ex9L-H 4P 63A A 30mA G	1/45
16 A	100 mA	4	108304	Ex9L-H 4P 16A A 100mA G	1/45
25 A	100 mA	4	108305	Ex9L-H 4P 25A A 100mA G	1/45
40 A	100 mA	4	108306	Ex9L-H 4P 40A A 100mA G	1/45
63 A	100 mA	4	108307	Ex9L-H 4P 63A A 100mA G	1/45
16 A	300 mA	4	108308	Ex9L-H 4P 16A A 300mA G	1/45
25 A	300 mA	4	108309	Ex9L-H 4P 25A A 300mA G	1/45
40 A	300 mA	4	108310	Ex9L-H 4P 40A A 300mA G	1/45
63 A	300 mA	4	108311	Ex9L-H 4P 63A A 300mA G	1/45

RCCBs Ex9L-H, 10 kA

S type, 2-pole

- S type of residual current circuit breaker based on AC type sensitive on residual AC current
- With time delay (insensitivity) 130 - 500 ms
- Surge current-proof 3000 A
- Suitable for protection against fire, as a main RCCB of a house or flat or as a protection against leakage currents (e.g. due to imperfect isolation)
- Selective with downstream installed AC or A type RCCB



Rated current	Rated residual current	Poles	Article No.	Type	Packing
16 A	100 mA	2	108216	Ex9L-H 2P 16A 100mA S	1/81
25 A	100 mA	2	108217	Ex9L-H 2P 25A 100mA S	1/81
40 A	100 mA	2	108218	Ex9L-H 2P 40A 100mA S	1/81
63 A	100 mA	2	108219	Ex9L-H 2P 63A 100mA S	1/81
16 A	300 mA	2	108220	Ex9L-H 2P 16A 300mA S	1/81
25 A	300 mA	2	108221	Ex9L-H 2P 25A 300mA S	1/81
40 A	300 mA	2	108222	Ex9L-H 2P 40A 300mA S	1/81
63 A	300 mA	2	108223	Ex9L-H 2P 63A 300mA S	1/81
16 A	500 mA	2	108224	Ex9L-H 2P 16A 500mA S	1/81
25 A	500 mA	2	108225	Ex9L-H 2P 25A 500mA S	1/81
40 A	500 mA	2	108226	Ex9L-H 2P 40A 500mA S	1/81
63 A	500 mA	2	108227	Ex9L-H 2P 63A 500mA S	1/81

S type, 4-pole



Rated current	Rated residual current	Poles	Article No.	Type	Packing
16 A	100 mA	4	108228	Ex9L-H 4P 16A 100mA S	1/45
25 A	100 mA	4	108229	Ex9L-H 4P 25A 100mA S	1/45
40 A	100 mA	4	108230	Ex9L-H 4P 40A 100mA S	1/45
63 A	100 mA	4	108231	Ex9L-H 4P 63A 100mA S	1/45
16 A	300 mA	4	108232	Ex9L-H 4P 16A 300mA S	1/45
25 A	300 mA	4	108233	Ex9L-H 4P 25A 300mA S	1/45
40 A	300 mA	4	108234	Ex9L-H 4P 40A 300mA S	1/45
63 A	300 mA	4	108235	Ex9L-H 4P 63A 300mA S	1/45
16 A	500 mA	4	108236	Ex9L-H 4P 16A 500mA S	1/45
25 A	500 mA	4	108237	Ex9L-H 4P 25A 500mA S	1/45
40 A	500 mA	4	108238	Ex9L-H 4P 40A 500mA S	1/45
63 A	500 mA	4	108239	Ex9L-H 4P 63A 500mA S	1/45

RCCBs Ex9L-H, 10 kA

S+A type, 2-pole

- S type of residual current circuit breaker based on A type sensitive on residual AC and pulsating DC current
- With time delay (insensitivity) 130 - 500 ms
- Surge current-proof 3000 A
- Suitable for protection against fire, as a main RCCB of a house or flat or as a protection against leakage currents (e.g. due to imperfect isolation)
- Selective with downstream installed AC or A type RCCB



Rated current	Rated residual current	Poles	Article No.	Type	Packing
16 A	100 mA	2	108240	Ex9L-H 2P 16A A 100mA S	1/81
25 A	100 mA	2	108241	Ex9L-H 2P 25A A 100mA S	1/81
40 A	100 mA	2	108242	Ex9L-H 2P 40A A 100mA S	1/81
63 A	100 mA	2	108243	Ex9L-H 2P 63A A 100mA S	1/81
16 A	300 mA	2	108244	Ex9L-H 2P 16A A 300mA S	1/81
25 A	300 mA	2	108245	Ex9L-H 2P 25A A 300mA S	1/81
40 A	300 mA	2	108246	Ex9L-H 2P 40A A 300mA S	1/81
63 A	300 mA	2	108247	Ex9L-H 2P 63A A 300mA S	1/81

S+A type, 4-pole



Rated current	Rated residual current	Poles	Article No.	Type	Packing
16 A	100 mA	4	108248	Ex9L-H 4P 16A A 100mA S	1/45
25 A	100 mA	4	108249	Ex9L-H 4P 25A A 100mA S	1/45
40 A	100 mA	4	108250	Ex9L-H 4P 40A A 100mA S	1/45
63 A	100 mA	4	108251	Ex9L-H 4P 63A A 100mA S	1/45
16 A	300 mA	4	108252	Ex9L-H 4P 16A A 300mA S	1/45
25 A	300 mA	4	108253	Ex9L-H 4P 25A A 300mA S	1/45
40 A	300 mA	4	108254	Ex9L-H 4P 40A A 300mA S	1/45
63 A	300 mA	4	108255	Ex9L-H 4P 63A A 300mA S	1/45

RCCBs Ex9L-H, 10 kA

Information sticker

- Sticker with information about regular monthly testing
- Languages EN, CZ, SK, FR, RU, PL, DE, RO
- In a scope of delivery of all magnetic RCCBs and RCBOs NOARK, spare part

Description	Languages	Article No.	Type	Packing
Information sticker	EN, CZ, SK, FR, RU, PL, DE, RO	101445	YS31	1

RCCBs Ex9L-N, 6 kA



- Residual Current Circuit Breakers according to EN 61008-1
- Cond. rated short circuit strength I_{nc} 6 kA
- 2 and 4-pole versions
- Rated residual current 10, 30, 100, 300 and 500 mA
- Rated current up to 63 A
- Rated operational voltage 230/400 V AC
- AC, A, S and G type
- Indication of electrical tripping
- Suitable for applications from -25 to +60 °C

Ex9L-N residual current circuit breakers are suitable mainly for domestic applications. They are based on permanent magnet principle. It brings the advantage of Voltage independent function. Adequate voltage is only necessary when testing the RCCB with the T test button. Magnetic RCCBs should be tested regularly with a period of one month.

6 kA variant of the Ex9L-N residual current circuit breaker is intended mainly for low demanding application like basic protection in household installations.

Type Key

Ex9	L	-N	2P	63 A	A	30mA	S
↓	↓	↓	↓	↓	↓	↓	↓
Product family	Product	Conditional short circuit strength	Poles	Rated current	Sensitivity to type of current	Rated residual current	Time delay (insensitivity)
Ex9	L: RCCB	-N: 6kA	2P 4P	16 A 25 A 40 A 63 A	_ : AC A: A	10 mA 30 mA 100 mA 300 mA 500 mA	_ : 0 ms G: 10-300 ms S: 130-500 ms

Certification marks



RCCBs Ex9L-N, 6 kA

AC type, 2-pole

- AC type of residual current circuit breaker sensitive on residual AC current
- Without time delay
- Surge current-proof 3000 A
- 30 mA version suitable for protection of people in case of direct and indirect contact with live parts and exposed conductive parts during a fault, respectively
- Selective with upstream installed S or S+A type RCCB



Rated current	Rated residual current	Poles	Article No.	Type	Packing
16 A	10 mA	2	108312	Ex9L-N 2P 16A 10mA	1/81
25 A	10 mA	2	108313	Ex9L-N 2P 25A 10mA	1/81
16 A	30 mA	2	108317	Ex9L-N 2P 16A 30mA	1/81
25 A	30 mA	2	108314	Ex9L-N 2P 25A 30mA	1/81
40 A	30 mA	2	108315	Ex9L-N 2P 40A 30mA	1/81
63 A	30 mA	2	108316	Ex9L-N 2P 63A 30mA	1/81
16 A	100 mA	2	108321	Ex9L-N 2P 16A 100mA	1/81
25 A	100 mA	2	108318	Ex9L-N 2P 25A 100mA	1/81
40 A	100 mA	2	108319	Ex9L-N 2P 40A 100mA	1/81
63 A	100 mA	2	108320	Ex9L-N 2P 63A 100mA	1/81
16 A	300 mA	2	108325	Ex9L-N 2P 16A 300mA	1/81
25 A	300 mA	2	108322	Ex9L-N 2P 25A 300mA	1/81
40 A	300 mA	2	108323	Ex9L-N 2P 40A 300mA	1/81
63 A	300 mA	2	108324	Ex9L-N 2P 63A 300mA	1/81
16 A	500 mA	2	108329	Ex9L-N 2P 16A 500mA	1/81
25 A	500 mA	2	108326	Ex9L-N 2P 25A 500mA	1/81
40 A	500 mA	2	108327	Ex9L-N 2P 40A 500mA	1/81
63 A	500 mA	2	108328	Ex9L-N 2P 63A 500mA	1/81

AC type, 4-pole



Rated current	Rated residual current	Poles	Article No.	Type	Packing
16 A	30 mA	4	108330	Ex9L-N 4P 16A 30mA	1/45
25 A	30 mA	4	108331	Ex9L-N 4P 25A 30mA	1/45
40 A	30 mA	4	108332	Ex9L-N 4P 40A 30mA	1/45
63 A	30 mA	4	108333	Ex9L-N 4P 63A 30mA	1/45
16 A	100 mA	4	108334	Ex9L-N 4P 16A 100mA	1/45
25 A	100 mA	4	108335	Ex9L-N 4P 25A 100mA	1/45
40 A	100 mA	4	108336	Ex9L-N 4P 40A 100mA	1/45
63 A	100 mA	4	108337	Ex9L-N 4P 63A 100mA	1/45
16 A	300 mA	4	108338	Ex9L-N 4P 16A 300mA	1/45
25 A	300 mA	4	108339	Ex9L-N 4P 25A 300mA	1/45
40 A	300 mA	4	108340	Ex9L-N 4P 40A 300mA	1/45
63 A	300 mA	4	108341	Ex9L-N 4P 63A 300mA	1/45
16 A	500 mA	4	108342	Ex9L-N 4P 16A 500mA	1/45
25 A	500 mA	4	108343	Ex9L-N 4P 25A 500mA	1/45
40 A	500 mA	4	108344	Ex9L-N 4P 40A 500mA	1/45
63 A	500 mA	4	108345	Ex9L-N 4P 63A 500mA	1/45

RCCBs Ex9L-N, 6 kA

A type, 2-pole

- A type of residual current circuit breaker sensitive on residual AC and pulsating DC current
- Without time delay
- Surge current-proof 3000 A
- 30 mA version suitable for protection of people in case of direct and indirect contact with live parts and exposed conductive parts during a fault, respectively
- Selective with upstream installed S or S+A type RCCB



Rated current	Rated residual current	Poles	Article No.	Type	Packing
16 A	10 mA	2	108346	Ex9L-N 2P 16A A 10mA	1/81
25 A	10 mA	2	108347	Ex9L-N 2P 25A A 10mA	1/81
16 A	30 mA	2	108348	Ex9L-N 2P 16A A 30mA	1/81
25 A	30 mA	2	108349	Ex9L-N 2P 25A A 30mA	1/81
40 A	30 mA	2	108350	Ex9L-N 2P 40A A 30mA	1/81
63 A	30 mA	2	108351	Ex9L-N 2P 63A A 30mA	1/81
16 A	100 mA	2	108352	Ex9L-N 2P 16A A 100mA	1/81
25 A	100 mA	2	108353	Ex9L-N 2P 25A A 100mA	1/81
40 A	100 mA	2	108354	Ex9L-N 2P 40A A 100mA	1/81
63 A	100 mA	2	108355	Ex9L-N 2P 63A A 100mA	1/81
16 A	300 mA	2	108356	Ex9L-N 2P 16A A 300mA	1/81
25 A	300 mA	2	108357	Ex9L-N 2P 25A A 300mA	1/81
40 A	300 mA	2	108358	Ex9L-N 2P 40A A 300mA	1/81
63 A	300 mA	2	108359	Ex9L-N 2P 63A A 300mA	1/81

A type, 4-pole



Rated current	Rated residual current	Poles	Article No.	Type	Packing
16 A	30 mA	4	108360	Ex9L-N 4P 16A A 30mA	1/45
25 A	30 mA	4	108361	Ex9L-N 4P 25A A 30mA	1/45
40 A	30 mA	4	108362	Ex9L-N 4P 40A A 30mA	1/45
63 A	30 mA	4	108363	Ex9L-N 4P 63A A 30mA	1/45
16 A	100 mA	4	108364	Ex9L-N 4P 16A A 100mA	1/45
25 A	100 mA	4	108365	Ex9L-N 4P 25A A 100mA	1/45
40 A	100 mA	4	108366	Ex9L-N 4P 40A A 100mA	1/45
63 A	100 mA	4	108367	Ex9L-N 4P 63A A 100mA	1/45
16 A	300 mA	4	108368	Ex9L-N 4P 16A A 300mA	1/45
25 A	300 mA	4	108369	Ex9L-N 4P 25A A 300mA	1/45
40 A	300 mA	4	108370	Ex9L-N 4P 40A A 300mA	1/45
63 A	300 mA	4	108371	Ex9L-N 4P 63A A 300mA	1/45

RCCBs Ex9L-N, 6 kA

G type, 2-pole

- G type of residual current circuit breaker based on AC type sensitive on residual AC current
- High reliability against unwanted tripping
- Compulsory for any circuit where personal injury or damage to property may occur in case of unwanted tripping
- With time delay (insensitivity) 10 - 300 ms
- Surge current-proof 3000 A
- 30 mA version suitable for protection of people in case of direct and indirect contact with live parts and exposed conductive parts during a fault, respectively



Rated current	Rated residual current	Poles	Article No.	Type	Packing
16 A	30 mA	2	108412	Ex9L-N 2P 16A 30mA G	1/81
25 A	30 mA	2	108413	Ex9L-N 2P 25A 30mA G	1/81
40 A	30 mA	2	108414	Ex9L-N 2P 40A 30mA G	1/81
63 A	30 mA	2	108415	Ex9L-N 2P 63A 30mA G	1/81
16 A	100 mA	2	108416	Ex9L-N 2P 16A 100mA G	1/81
25 A	100 mA	2	108417	Ex9L-N 2P 25A 100mA G	1/81
40 A	100 mA	2	108418	Ex9L-N 2P 40A 100mA G	1/81
63 A	100 mA	2	108419	Ex9L-N 2P 63A 100mA G	1/81
16 A	300 mA	2	108420	Ex9L-N 2P 16A 300mA G	1/81
25 A	300 mA	2	108421	Ex9L-N 2P 25A 300mA G	1/81
40 A	300 mA	2	108422	Ex9L-N 2P 40A 300mA G	1/81
63 A	300 mA	2	108423	Ex9L-N 2P 63A 300mA G	1/81
16 A	500 mA	2	108424	Ex9L-N 2P 16A 500mA G	1/81
25 A	500 mA	2	108425	Ex9L-N 2P 25A 500mA G	1/81
40 A	500 mA	2	108426	Ex9L-N 2P 40A 500mA G	1/81
63 A	500 mA	2	108427	Ex9L-N 2P 63A 500mA G	1/81

G type, 4-pole



Rated current	Rated residual current	Poles	Article No.	Type	Packing
16 A	30 mA	4	108428	Ex9L-N 4P 16A 30mA G	1/45
25 A	30 mA	4	108429	Ex9L-N 4P 25A 30mA G	1/45
40 A	30 mA	4	108430	Ex9L-N 4P 40A 30mA G	1/45
63 A	30 mA	4	108431	Ex9L-N 4P 63A 30mA G	1/45
16 A	100 mA	4	108432	Ex9L-N 4P 16A 100mA G	1/45
25 A	100 mA	4	108433	Ex9L-N 4P 25A 100mA G	1/45
40 A	100 mA	4	108434	Ex9L-N 4P 40A 100mA G	1/45
63 A	100 mA	4	108435	Ex9L-N 4P 63A 100mA G	1/45
16 A	300 mA	4	108436	Ex9L-N 4P 16A 300mA G	1/45
25 A	300 mA	4	108437	Ex9L-N 4P 25A 300mA G	1/45
40 A	300 mA	4	108438	Ex9L-N 4P 40A 300mA G	1/45
63 A	300 mA	4	108439	Ex9L-N 4P 63A 300mA G	1/45
16 A	500 mA	4	108440	Ex9L-N 4P 16A 500mA G	1/45
25 A	500 mA	4	108441	Ex9L-N 4P 25A 500mA G	1/45
40 A	500 mA	4	108442	Ex9L-N 4P 40A 500mA G	1/45
63 A	500 mA	4	108443	Ex9L-N 4P 63A 500mA G	1/45

RCCBs Ex9L-N, 6 kA

G+A type, 2-pole

- G type of residual current circuit breaker based on A type sensitive on residual AC and pulsating DC current
- High reliability against unwanted tripping
- Compulsory for any circuit where personal injury or damage to property may occur in case of unwanted tripping
- With time delay (insensitivity) 10 - 300 ms
- Surge current-proof 3000 A
- 30 mA version suitable for protection of people in case of direct and indirect contact with live parts and exposed conductive parts during a fault, respectively



Rated current	Rated residual current	Poles	Article No.	Type	Packing
16 A	30 mA	2	108444	Ex9L-N 2P 16A A 30mA G	1/81
25 A	30 mA	2	108445	Ex9L-N 2P 25A A 30mA G	1/81
40 A	30 mA	2	108446	Ex9L-N 2P 40A A 30mA G	1/81
63 A	30 mA	2	108447	Ex9L-N 2P 63A A 30mA G	1/81
16 A	100 mA	2	108448	Ex9L-N 2P 16A A 100mA G	1/81
25 A	100 mA	2	108449	Ex9L-N 2P 25A A 100mA G	1/81
40 A	100 mA	2	108450	Ex9L-N 2P 40A A 100mA G	1/81
63 A	100 mA	2	108451	Ex9L-N 2P 63A A 100mA G	1/81
16 A	300 mA	2	108452	Ex9L-N 2P 16A A 300mA G	1/81
25 A	300 mA	2	108453	Ex9L-N 2P 25A A 300mA G	1/81
40 A	300 mA	2	108454	Ex9L-N 2P 40A A 300mA G	1/81
63 A	300 mA	2	108455	Ex9L-N 2P 63A A 300mA G	1/81

G+A type, 4-pole



Rated current	Rated residual current	Poles	Article No.	Type	Packing
16 A	30 mA	4	108456	Ex9L-N 4P 16A A 30mA G	1/45
25 A	30 mA	4	108457	Ex9L-N 4P 25A A 30mA G	1/45
40 A	30 mA	4	108458	Ex9L-N 4P 40A A 30mA G	1/45
63 A	30 mA	4	108459	Ex9L-N 4P 63A A 30mA G	1/45
16 A	100 mA	4	108460	Ex9L-N 4P 16A A 100mA G	1/45
25 A	100 mA	4	108461	Ex9L-N 4P 25A A 100mA G	1/45
40 A	100 mA	4	108462	Ex9L-N 4P 40A A 100mA G	1/45
63 A	100 mA	4	108463	Ex9L-N 4P 63A A 100mA G	1/45
16 A	300 mA	4	108464	Ex9L-N 4P 16A A 300mA G	1/45
25 A	300 mA	4	108465	Ex9L-N 4P 25A A 300mA G	1/45
40 A	300 mA	4	108466	Ex9L-N 4P 40A A 300mA G	1/45
63 A	300 mA	4	108467	Ex9L-N 4P 63A A 300mA G	1/45

RCCBs Ex9L-N, 6 kA

S type, 2-pole

- S type of residual current circuit breaker based on AC type sensitive on residual AC current
- With time delay (insensitivity) 130 - 500 ms
- Surge current-proof 3000 A
- Suitable for protection against fire, as a main RCCB of a house or flat or as a protection against leakage currents (e.g. due to imperfect isolation)
- Selective with downstream installed AC or A type RCCB



Rated current	Rated residual current	Poles	Article No.	Type	Packing
16 A	100 mA	2	108372	Ex9L-N 2P 16A 100mA S	1/81
25 A	100 mA	2	108373	Ex9L-N 2P 25A 100mA S	1/81
40 A	100 mA	2	108374	Ex9L-N 2P 40A 100mA S	1/81
63 A	100 mA	2	108375	Ex9L-N 2P 63A 100mA S	1/81
16 A	300 mA	2	108376	Ex9L-N 2P 16A 300mA S	1/81
25 A	300 mA	2	108377	Ex9L-N 2P 25A 300mA S	1/81
40 A	300 mA	2	108378	Ex9L-N 2P 40A 300mA S	1/81
63 A	300 mA	2	108379	Ex9L-N 2P 63A 300mA S	1/81
16 A	500 mA	2	108380	Ex9L-N 2P 16A 500mA S	1/81
25 A	500 mA	2	108381	Ex9L-N 2P 25A 500mA S	1/81
40 A	500 mA	2	108382	Ex9L-N 2P 40A 500mA S	1/81
63 A	500 mA	2	108383	Ex9L-N 2P 63A 500mA S	1/81

S type, 4-pole



Rated current	Rated residual current	Poles	Article No.	Type	Packing
16 A	100 mA	4	108384	Ex9L-N 4P 16A 100mA S	1/45
25 A	100 mA	4	108385	Ex9L-N 4P 25A 100mA S	1/45
40 A	100 mA	4	108386	Ex9L-N 4P 40A 100mA S	1/45
63 A	100 mA	4	108387	Ex9L-N 4P 63A 100mA S	1/45
16 A	300 mA	4	108388	Ex9L-N 4P 16A 300mA S	1/45
25 A	300 mA	4	108389	Ex9L-N 4P 25A 300mA S	1/45
40 A	300 mA	4	108390	Ex9L-N 4P 40A 300mA S	1/45
63 A	300 mA	4	108391	Ex9L-N 4P 63A 300mA S	1/45
16 A	500 mA	4	108392	Ex9L-N 4P 16A 500mA S	1/45
25 A	500 mA	4	108393	Ex9L-N 4P 25A 500mA S	1/45
40 A	500 mA	4	108394	Ex9L-N 4P 40A 500mA S	1/45
63 A	500 mA	4	108395	Ex9L-N 4P 63A 500mA S	1/45

RCCBs Ex9L-N, 6 kA

S+A type, 2-pole

- S type of residual current circuit breaker based on A type sensitive on residual AC and pulsating DC current
- With time delay (insensitivity) 130 - 500 ms
- Surge current-proof 3000 A
- Suitable for protection against fire, as a main RCCB of a house or flat or as a protection against leakage currents (e.g. due to imperfect isolation)
- Selective with downstream installed AC or A type RCCB



Rated current	Rated residual current	Poles	Article No.	Type	Packing
16 A	100 mA	2	108396	Ex9L-N 2P 16A A 100mA S	1/81
25 A	100 mA	2	108397	Ex9L-N 2P 25A A 100mA S	1/81
40 A	100 mA	2	108398	Ex9L-N 2P 40A A 100mA S	1/81
63 A	100 mA	2	108399	Ex9L-N 2P 63A A 100mA S	1/81
16 A	300 mA	2	108400	Ex9L-N 2P 16A A 300mA S	1/81
25 A	300 mA	2	108401	Ex9L-N 2P 25A A 300mA S	1/81
40 A	300 mA	2	108402	Ex9L-N 2P 40A A 300mA S	1/81
63 A	300 mA	2	108403	Ex9L-N 2P 63A A 300mA S	1/81

S+A type, 4-pole



Rated current	Rated residual current	Poles	Article No.	Type	Packing
16 A	100 mA	4	108404	Ex9L-N 4P 16A A 100mA S	1/45
25 A	100 mA	4	108405	Ex9L-N 4P 25A A 100mA S	1/45
40 A	100 mA	4	108406	Ex9L-N 4P 40A A 100mA S	1/45
63 A	100 mA	4	108407	Ex9L-N 4P 63A A 100mA S	1/45
16 A	300 mA	4	108408	Ex9L-N 4P 16A A 300mA S	1/45
25 A	300 mA	4	108409	Ex9L-N 4P 25A A 300mA S	1/45
40 A	300 mA	4	108410	Ex9L-N 4P 40A A 300mA S	1/45
63 A	300 mA	4	108411	Ex9L-N 4P 63A A 300mA S	1/45

RCCBs Ex9L-N, 6 kA

Information sticker

- Sticker with information about regular monthly testing
- Languages EN, CZ, SK, FR, RU, PL, DE, RO
- In a scope of delivery of all magnetic RCCBs and RCBOs NOARK, spare part

Description	Languages	Article No.	Type	Packing
Information sticker	EN, CZ, SK, FR, RU, PL, DE, RO	101445	YS31	1

RCCBs Ex9CL-100, 10 kA



- Residual Current Circuit Breakers according to IEC / EN 61008-1
- Conditional rated short circuit strength I_{nc} 10 kA
- 2 and 4-pole versions
- Rated residual current 100, 300 mA
- Rated current up to 100 A
- Rated operational voltage 230/400 V AC
- S and S+A types
- Indication of electrical tripping

Ex9CL-100 residual current circuit breakers are suitable for domestic as well as industrial applications. They are based on permanent magnet principle. It brings the advantage of Voltage independent function. Adequate voltage is only necessary when testing of the RCCB with the T test button. Magnetic RCCBs should be tested regularly with a period of one month.

Type Key

Ex9	CL	-100	2P	63 A	A	100mA	S
↓	↓	↓	↓	↓	↓	↓	↓
Product family	Product	Conditional short circuit strength	Poles	Rated current	Sensitivity to type of current	Rated residual current	Time delay (insensitivity)
Ex9	CL: RCCB	-100: 10 kA (up to 100 A)	2, 4	63, 80, 100 A	~: AC A: A	100, 300 mA	S: 40 ms

Certification marks



RCCBs Ex9CL-100, 10 kA

S type, 2-pole

- S type of residual current circuit breaker based on AC type sensitive on residual AC current
- With time delay (insensitivity) 40 ms
- Surge current-proof 3000 A
- Suitable for protection against fire, as a main RCCB of a house or flat or as a protection against leakage currents (e.g. due to imperfect isolation)
- Selective with downstream installed AC or A type RCCB



Rated current	Rated residual current	Poles	Article No.	Type	Packing
63 A	100 mA	2	100715	Ex9CL-100 2P 63A 100mA S	1/81
80 A	100 mA	2	100717	Ex9CL-100 2P 80A 100mA S	1/81
100 A	100 mA	2	100719	Ex9CL-100 2P 100A 100mA S	1/81
63 A	300 mA	2	100716	Ex9CL-100 2P 63A 300mA S	1/81
80 A	300 mA	2	100718	Ex9CL-100 2P 80A 300mA S	1/81
100 A	300 mA	2	100720	Ex9CL-100 2P 100A 300mA S	1/81

S type, 4-pole

- S type of residual current circuit breaker based on AC type sensitive on residual AC current
- With time delay (insensitivity) 40 ms
- Surge current-proof 3000 A
- Suitable for protection against fire, as a main RCCB of a house or flat or as a protection against leakage currents (e.g. due to imperfect isolation)
- Selective with downstream installed AC or A type RCCB



Rated current	Rated residual current	Poles	Article No.	Type	Packing
63 A	100 mA	4	100721	Ex9CL-100 4P 63A 100mA S	1/45
80 A	100 mA	4	100723	Ex9CL-100 4P 80A 100mA S	1/45
100 A	100 mA	4	100725	Ex9CL-100 4P 100A 100mA S	1/45
63 A	300 mA	4	100722	Ex9CL-100 4P 63A 300mA S	1/45
80 A	300 mA	4	100724	Ex9CL-100 4P 80A 300mA S	1/45
100 A	300 mA	4	100726	Ex9CL-100 4P 100A 300mA S	1/45

RCCBs Ex9CL-100, 10 kA

S+A type, 2-pole

- S type of residual current circuit breaker based on A type sensitive on residual AC and pulsating DC current
- With time delay (insensitivity) 40 ms
- Surge current-proof 3000 A
- Suitable for protection against fire, as a main RCCB of a house or flat or as a protection against leakage currents (e.g. due to imperfect isolation)
- Selective with downstream installed AC or A type RCCB



Rated current	Rated residual current	Poles	Article No.	Type	Packing
63 A	100 mA	2	100727	Ex9CL-100 2P 63A A 100mA S	1/81
80 A	100 mA	2	100729	Ex9CL-100 2P 80A A 100mA S	1/81
100 A	100 mA	2	100731	Ex9CL-100 2P 100A A 100mA S	1/81
63 A	300 mA	2	100728	Ex9CL-100 2P 63A A 300mA S	1/81
80 A	300 mA	2	100730	Ex9CL-100 2P 80A A 300mA S	1/81
100 A	300 mA	2	100732	Ex9CL-100 2P 100A A 300mA S	1/81

S+A type, 4-pole

- S type of residual current circuit breaker based on A type sensitive on residual AC and pulsating DC current
- With time delay (insensitivity) 40 ms
- Surge current-proof 3000 A
- Suitable for protection against fire, as a main RCCB of a house or flat or as a protection against leakage currents (e.g. due to imperfect isolation)
- Selective with downstream installed AC or A type RCCB



Rated current	Rated residual current	Poles	Article No.	Type	Packing
63 A	100 mA	4	100733	Ex9CL-100 4P 63A A 100mA S	1/45
80 A	100 mA	4	100735	Ex9CL-100 4P 80A A 100mA S	1/45
100 A	100 mA	4	100737	Ex9CL-100 4P 100A A 100mA S	1/45
63 A	300 mA	4	100734	Ex9CL-100 4P 63A A 300mA S	1/45
80 A	300 mA	4	100736	Ex9CL-100 4P 80A A 300mA S	1/45
100 A	300 mA	4	100738	Ex9CL-100 4P 100A A 300mA S	1/45

RCCBs Ex9CL-100, 10 kA

Information sticker

- Sticker with information about regular monthly testing
- Languages EN, CZ, SK, FR, RU, PL, DE, RO
- In a scope of delivery of all magnetic RCCBs and RCBOs NOARK, spare part

Description	Languages	Article No.	Type	Packing
Information sticker	EN, CZ, SK, FR, RU, PL, DE, RO	101445	YS31	1

B type RCCBs Ex9LB63



- Residual Current Circuit Breakers according to IEC/EN 61008-1 and IEC/EN 62423
- Cond. rated short circuit strength I_{nc} 10 kA
- B type
- 2 and 4-pole versions
- Rated residual current 30, 100 and 300 mA
- Rated current up to 63 A
- Rated operational voltage 230/400 V AC
- Indication of electrical tripping
- Suitable for applications from -25 to +40 °C

Residual current circuit breakers B type Ex9LB63 are suitable for domestic as well as industrial applications, where are used frequency inverters, PV plant, EV chargers and similar elements. B type provides a sensitivity to residual AC, pulsating and smooth DC current, together with high frequencies up to 1 kHz.

They are based on electronic technology, which brings advantages of more accurate measuring of residual current and, as a consequence, reduction of unwanted tripping. These devices also do not suffer with magnetization of the tripping unit. Thus, there is no mandatory testing period, but they must be tested regularly. On this testing period local law or regulations may apply. Recommend is to test it every 6 months in fair environment and every month in heavy condition.

Type Key

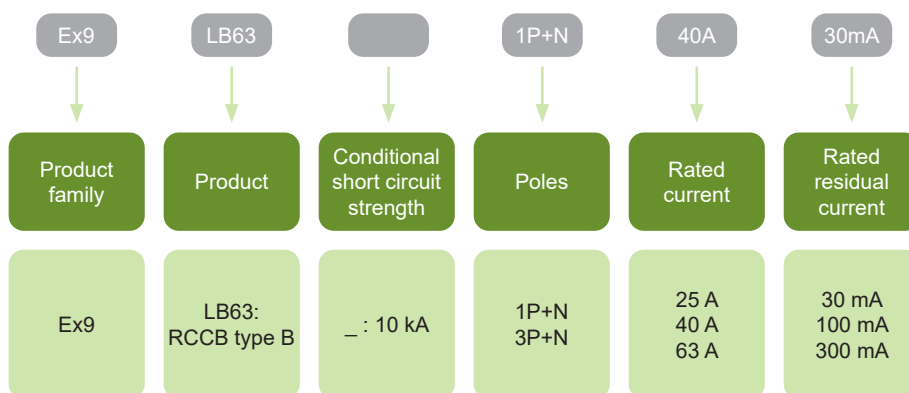

Certification marks



B type RCCBs Ex9LB63

B type, 2-pole

- B type - sensitivity to residual AC, pulsating and smooth DC current, high frequency up to 1 kHz
- Without time delay
- Surge current-proof 3000 A
- 30 mA version suitable for protection of people in case of direct and indirect contact with live parts and exposed conductive parts during a fault, respectively



Rated current	Rated residual current	Poles	Article No.	Type	Packing
25 A	30 mA	2	110212	Ex9LB63 1P+N 25A 30mA	1/72
40 A	30 mA	2	110213	Ex9LB63 1P+N 40A 30mA	1/72
63 A	30 mA	2	110214	Ex9LB63 1P+N 63A 30mA	1/72
25 A	100 mA	2	110215	Ex9LB63 1P+N 25A 100mA	1/72
40 A	100 mA	2	110216	Ex9LB63 1P+N 40A 100mA	1/72
63 A	100 mA	2	110217	Ex9LB63 1P+N 63A 100mA	1/72
25 A	300 mA	2	110218	Ex9LB63 1P+N 25A 300mA	1/72
40 A	300 mA	2	110219	Ex9LB63 1P+N 40A 300mA	1/72
63 A	300 mA	2	110220	Ex9LB63 1P+N 63A 300mA	1/72

B type, 4-pole



Rated current	Rated residual current	Poles	Article No.	Type	Packing
25 A	30 mA	4	110221	Ex9LB63 3P+N 25A 30mA	1/45
40 A	30 mA	4	110222	Ex9LB63 3P+N 40A 30mA	1/45
63 A	30 mA	4	110223	Ex9LB63 3P+N 63A 30mA	1/45
25 A	100 mA	4	110224	Ex9LB63 3P+N 25A 100mA	1/45
40 A	100 mA	4	110225	Ex9LB63 3P+N 40A 100mA	1/45
63 A	100 mA	4	110226	Ex9LB63 3P+N 63A 100mA	1/45
25 A	300 mA	4	110227	Ex9LB63 3P+N 25A 300mA	1/45
40 A	300 mA	4	110228	Ex9LB63 3P+N 40A 300mA	1/45
63 A	300 mA	4	110229	Ex9LB63 3P+N 63A 300mA	1/45

RCBOs Ex9BL-H, 10 kA



- Residual Current circuit Breakers with Overload protection according to EN 61009
- Rated breaking capacity I_{cn} 10 kA
- 1+N-pole version
- Rated residual current 30, 100, 300 mA
- Rated currents up to 40 A
- B and C tripping characteristics of installed circuit breaker
- AC and A type of RCBO
- 2-module width
- Suitable for applications from -25 to +40°C

Ex9BL residual current circuit breakers are suitable for domestic as well as industrial applications. They are based on combination of residual current device with permanent magnet principle and circuit breaker with thermal overload release and magnetic short circuit current release. It brings the advantage of voltage independent function of the residual current device. Adequate voltage is only necessary when testing the RCBO with the T test button. Magnetic RCBOs should be tested regularly with a period of one month.

Type Key

Ex9	BL	-H	1PN	B	16A	A	30mA
↓	↓	↓	↓	↓	↓	↓	↓
Product family	Product	Rated breaking capacity	Poles	Tripping characteristic of MCB	Rated current	Sensitivity to type of current	Rated residual current
Ex9	BL: RCBO	-H: 10 kA	1P+N	B C	6 — 40 A	—: AC A: A	30 mA 100 mA 300 mA

Certification marks



RCBOs Ex9BL-H, 10 kA

Accessories

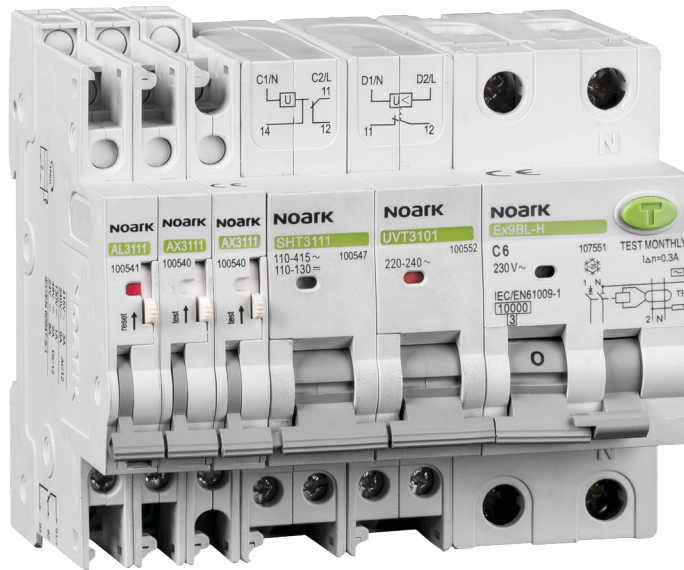

Auxiliary or signal contacts
AX, AL, AXL
Up to 3 units

Voltage or trip releases
SHT, UVT
Up to 2 units

RCBO
Ex9BL
2-module width

Auxiliary contacts AX3111, AX3122

see page 132

Alarm contact AL3111

see page 132

Auxiliary and alarm contact AXL31

see page 132

Shunt trip releases SHT31, SHT3111

see page 132

Undervoltage releases UVT31, UVT3101, UVT3110

see page 133

All accessories are mounted to the RCBOs Ex9BL from the left side and are identical for devices of the whole line Ex9B, Ex9PN and Ex9IP.

RCBOs Ex9BL-H, 10 kA

AC type, characteristic B

- AC type of residual current circuit breaker sensitive on residual AC current
- B characteristic of installed circuit breaker
- Without time delay
- Surge current-proof 3000 A
- Suitable for protection of people in case of direct and indirect contact with live parts and exposed conductive parts during a fault, respectively
- Selective with upstream installed S or S+A type RCCB



Rated current	Rated residual current	MCB tripping char.	Article No.	Type	Packing
6 A	30 mA	B	107381	Ex9BL-H 1P+N B6 30mA	1/6/72
10 A	30 mA	B	107382	Ex9BL-H 1P+N B10 30mA	1/6/72
13 A	30 mA	B	107383	Ex9BL-H 1P+N B13 30mA	1/6/72
16 A	30 mA	B	107384	Ex9BL-H 1P+N B16 30mA	1/6/72
20 A	30 mA	B	107385	Ex9BL-H 1P+N B20 30mA	1/6/72
25 A	30 mA	B	107386	Ex9BL-H 1P+N B25 30mA	1/6/72
32 A	30 mA	B	107387	Ex9BL-H 1P+N B32 30mA	1/6/72
40 A	30 mA	B	107388	Ex9BL-H 1P+N B40 30mA	1/6/72
6 A	100 mA	B	107461	Ex9BL-H 1P+N B6 100mA	1/6/72
10 A	100 mA	B	107462	Ex9BL-H 1P+N B10 100mA	1/6/72
13 A	100 mA	B	107463	Ex9BL-H 1P+N B13 100mA	1/6/72
16 A	100 mA	B	107464	Ex9BL-H 1P+N B16 100mA	1/6/72
20 A	100 mA	B	107465	Ex9BL-H 1P+N B20 100mA	1/6/72
25 A	100 mA	B	107466	Ex9BL-H 1P+N B25 100mA	1/6/72
32 A	100 mA	B	107467	Ex9BL-H 1P+N B32 100mA	1/6/72
40 A	100 mA	B	107468	Ex9BL-H 1P+N B40 100mA	1/6/72
6 A	300 mA	B	107541	Ex9BL-H 1P+N B6 300mA	1/6/72
10 A	300 mA	B	107542	Ex9BL-H 1P+N B10 300mA	1/6/72
13 A	300 mA	B	107543	Ex9BL-H 1P+N B13 300mA	1/6/72
16 A	300 mA	B	107544	Ex9BL-H 1P+N B16 300mA	1/6/72
20 A	300 mA	B	107545	Ex9BL-H 1P+N B20 300mA	1/6/72
25 A	300 mA	B	107546	Ex9BL-H 1P+N B25 300mA	1/6/72
32 A	300 mA	B	107547	Ex9BL-H 1P+N B32 300mA	1/6/72
40 A	300 mA	B	107548	Ex9BL-H 1P+N B40 300mA	1/6/72

RCBOs Ex9BL-H, 10 kA

AC type, characteristic C

- AC type of residual current circuit breaker sensitive on residual AC current
- C characteristic of installed circuit breaker
- Without time delay
- Surge current-proof 3000 A
- Suitable for protection of people in case of direct and indirect contact with live parts and exposed conductive parts during a fault, respectively
- Selective with upstream installed S or S+A type RCCB



Rated current	Rated residual current	MCB tripping char.	Article No.	Type	Packing
6 A	30 mA	C	107391	Ex9BL-H 1P+N C6 30mA	1/6/72
10 A	30 mA	C	107392	Ex9BL-H 1P+N C10 30mA	1/6/72
13 A	30 mA	C	107393	Ex9BL-H 1P+N C13 30mA	1/6/72
16 A	30 mA	C	107394	Ex9BL-H 1P+N C16 30mA	1/6/72
20 A	30 mA	C	107395	Ex9BL-H 1P+N C20 30mA	1/6/72
25 A	30 mA	C	107396	Ex9BL-H 1P+N C25 30mA	1/6/72
32 A	30 mA	C	107397	Ex9BL-H 1P+N C32 30mA	1/6/72
40 A	30 mA	C	107398	Ex9BL-H 1P+N C40 30mA	1/6/72
6 A	100 mA	C	107471	Ex9BL-H 1P+N C6 100mA	1/6/72
10 A	100 mA	C	107472	Ex9BL-H 1P+N C10 100mA	1/6/72
13 A	100 mA	C	107473	Ex9BL-H 1P+N C13 100mA	1/6/72
16 A	100 mA	C	107474	Ex9BL-H 1P+N C16 100mA	1/6/72
20 A	100 mA	C	107475	Ex9BL-H 1P+N C20 100mA	1/6/72
25 A	100 mA	C	107476	Ex9BL-H 1P+N C25 100mA	1/6/72
32 A	100 mA	C	107477	Ex9BL-H 1P+N C32 100mA	1/6/72
40 A	100 mA	C	107478	Ex9BL-H 1P+N C40 100mA	1/6/72
6 A	300 mA	C	107551	Ex9BL-H 1P+N C6 300mA	1/6/72
10 A	300 mA	C	107552	Ex9BL-H 1P+N C10 300mA	1/6/72
13 A	300 mA	C	107553	Ex9BL-H 1P+N C13 300mA	1/6/72
16 A	300 mA	C	107554	Ex9BL-H 1P+N C16 300mA	1/6/72
20 A	300 mA	C	107555	Ex9BL-H 1P+N C20 300mA	1/6/72
25 A	300 mA	C	107556	Ex9BL-H 1P+N C25 300mA	1/6/72
32 A	300 mA	C	107557	Ex9BL-H 1P+N C32 300mA	1/6/72
40 A	300 mA	C	107558	Ex9BL-H 1P+N C40 300mA	1/6/72

RCBOs Ex9BL-H, 10 kA

A type, characteristic B

- A type of residual current circuit breaker sensitive on residual AC and pulsating DC current
- B characteristic of installed circuit breaker
- Without time delay
- Surge current-proof 3000 A
- Suitable for protection of people in case of direct and indirect contact with live parts and exposed conductive parts during a fault, respectively
- Selective with upstream installed S or S+A type RCCB



Rated current	Rated residual current	MCB tripping char.	Article No.	Type	Packing
6 A	30 mA	B	107401	Ex9BL-H 1P+N B6 A 30mA	1/6/72
10 A	30 mA	B	107402	Ex9BL-H 1P+N B10 A 30mA	1/6/72
13 A	30 mA	B	107403	Ex9BL-H 1P+N B13 A 30mA	1/6/72
16 A	30 mA	B	107404	Ex9BL-H 1P+N B16 A 30mA	1/6/72
20 A	30 mA	B	107405	Ex9BL-H 1P+N B20 A 30mA	1/6/72
25 A	30 mA	B	107406	Ex9BL-H 1P+N B25 A 30mA	1/6/72
32 A	30 mA	B	107407	Ex9BL-H 1P+N B32 A 30mA	1/6/72
40 A	30 mA	B	107408	Ex9BL-H 1P+N B40 A 30mA	1/6/72
6 A	100 mA	B	107481	Ex9BL-H 1P+N B6 A 100mA	1/6/72
10 A	100 mA	B	107482	Ex9BL-H 1P+N B10 A 100mA	1/6/72
13 A	100 mA	B	107483	Ex9BL-H 1P+N B13 A 100mA	1/6/72
16 A	100 mA	B	107484	Ex9BL-H 1P+N B16 A 100mA	1/6/72
20 A	100 mA	B	107485	Ex9BL-H 1P+N B20 A 100mA	1/6/72
25 A	100 mA	B	107486	Ex9BL-H 1P+N B25 A 100mA	1/6/72
32 A	100 mA	B	107487	Ex9BL-H 1P+N B32 A 100mA	1/6/72
40 A	100 mA	B	107488	Ex9BL-H 1P+N B40 A 100mA	1/6/72
6 A	300 mA	B	107561	Ex9BL-H 1P+N B6 A 300mA	1/6/72
10 A	300 mA	B	107562	Ex9BL-H 1P+N B10 A 300mA	1/6/72
13 A	300 mA	B	107563	Ex9BL-H 1P+N B13 A 300mA	1/6/72
16 A	300 mA	B	107564	Ex9BL-H 1P+N B16 A 300mA	1/6/72
20 A	300 mA	B	107565	Ex9BL-H 1P+N B20 A 300mA	1/6/72
25 A	300 mA	B	107566	Ex9BL-H 1P+N B25 A 300mA	1/6/72
32 A	300 mA	B	107567	Ex9BL-H 1P+N B32 A 300mA	1/6/72
40 A	300 mA	B	107568	Ex9BL-H 1P+N B40 A 300mA	1/6/72

RCBOs Ex9BL-H, 10 kA

A type, characteristic C

- A type of residual current circuit breaker sensitive on residual AC and pulsating DC current
- C characteristic of installed circuit breaker
- Without time delay
- Surge current-proof 3000 A
- Suitable for protection of people in case of direct and indirect contact with live parts and exposed conductive parts during a fault, respectively
- Selective with upstream installed S or S+A type RCCB



Rated current	Rated residual current	MCB tripping char.	Article No.	Type	Packing
6 A	30 mA	C	107411	Ex9BL-H 1P+N C6 A 30mA	1/6/72
10 A	30 mA	C	107412	Ex9BL-H 1P+N C10 A 30mA	1/6/72
13 A	30 mA	C	107413	Ex9BL-H 1P+N C13 A 30mA	1/6/72
16 A	30 mA	C	107414	Ex9BL-H 1P+N C16 A 30mA	1/6/72
20 A	30 mA	C	107415	Ex9BL-H 1P+N C20 A 30mA	1/6/72
25 A	30 mA	C	107416	Ex9BL-H 1P+N C25 A 30mA	1/6/72
32 A	30 mA	C	107417	Ex9BL-H 1P+N C32 A 30mA	1/6/72
40 A	30 mA	C	107418	Ex9BL-H 1P+N C40 A 30mA	1/6/72
6 A	100 mA	C	107491	Ex9BL-H 1P+N C6 A 100mA	1/6/72
10 A	100 mA	C	107492	Ex9BL-H 1P+N C10 A 100mA	1/6/72
13 A	100 mA	C	107493	Ex9BL-H 1P+N C13 A 100mA	1/6/72
16 A	100 mA	C	107494	Ex9BL-H 1P+N C16 A 100mA	1/6/72
20 A	100 mA	C	107495	Ex9BL-H 1P+N C20 A 100mA	1/6/72
25 A	100 mA	C	107496	Ex9BL-H 1P+N C25 A 100mA	1/6/72
32 A	100 mA	C	107497	Ex9BL-H 1P+N C32 A 100mA	1/6/72
40 A	100 mA	C	107498	Ex9BL-H 1P+N C40 A 100mA	1/6/72
6 A	300 mA	C	107571	Ex9BL-H 1P+N C6 A 300mA	1/6/72
10 A	300 mA	C	107572	Ex9BL-H 1P+N C10 A 300mA	1/6/72
13 A	300 mA	C	107573	Ex9BL-H 1P+N C13 A 300mA	1/6/72
16 A	300 mA	C	107574	Ex9BL-H 1P+N C16 A 300mA	1/6/72
20 A	300 mA	C	107575	Ex9BL-H 1P+N C20 A 300mA	1/6/72
25 A	300 mA	C	107576	Ex9BL-H 1P+N C25 A 300mA	1/6/72
32 A	300 mA	C	107577	Ex9BL-H 1P+N C32 A 300mA	1/6/72
40 A	300 mA	C	107578	Ex9BL-H 1P+N C40 A 300mA	1/6/72

Information sticker

- Sticker with information about regular monthly testing
- Languages EN, CZ, SK, FR, RU, PL, DE, RO
- In a scope of delivery of all magnetic RCCBs and RCBOs NOARK, spare part

Description	Languages	Article No.	Type	Packing
Information sticker	EN, CZ, SK, FR, RU, PL, DE, RO	101445	YS31	1

RCBOs Ex9BL-N, 6 kA



- Residual Current circuit Breakers with Overload protection according to EN 61009
- Rated breaking capacity I_{cn} 6 kA
- 1+N-pole version
- Rated residual current 30, 100, 300 mA
- Rated currents up to 40 A
- B and C tripping characteristics of installed circuit breaker
- AC and A type of RCBO
- 2-module width
- Suitable for applications from -25 to +40°C

Ex9BL residual current circuit breakers are suitable for domestic as well as industrial applications. They are based on combination of residual current device with permanent magnet principle and circuit breaker with thermal overload release and magnetic short circuit current release. It brings the advantage of voltage independent function of the residual current device. Adequate voltage is only necessary when testing the RCBO with the T test button. Magnetic RCBOs should be tested regularly with a period of one month.

Type Key

Ex9	BL	-N	1PN	B	16A	A	30mA
↓	↓	↓	↓	↓	↓	↓	↓
Product family	Product	Rated breaking capacity	Poles	Tripping characteristic of MCB	Rated current	Sensitivity to type of current	Rated residual current
Ex9	BL: RCBO	-N: 6 kA	1P+N	B C	6 — 40 A	_: AC A: A	30 mA 100 mA 300 mA

Certification marks



RCBOs Ex9BL-N, 6 kA

Accessories

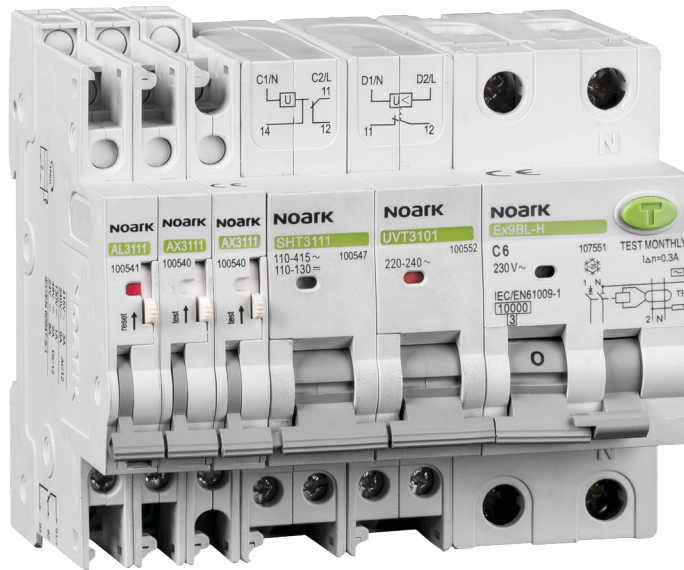

Auxiliary or signal contacts
AX, AL, AXL
Up to 3 units

Voltage or trip releases
SHT, UVT
Up to 2 units

RCBO
Ex9BL
2-module width

Auxiliary contacts AX3111, AX3122

see page 132

Alarm contact AL3111

see page 132

Auxiliary and alarm contact AXL31

see page 132

Shunt trip releases SHT31, SHT3111

see page 132

Undervoltage releases UVT31, UVT3101, UVT3110

see page 133

All accessories are mounted to the RCBOs Ex9BL from the left side and are identical for devices of the whole line Ex9B, Ex9PN and Ex9IP.

RCBOs Ex9BL-N, 6 kA

AC type, characteristic B

- AC type of residual current circuit breaker sensitive on residual AC current
- B characteristic of installed circuit breaker
- Without time delay
- Surge current-proof 3000 A
- Suitable for protection of people in case of direct and indirect contact with live parts and exposed conductive parts during a fault, respectively
- Selective with upstream installed S or S+A type RCCB



Rated current	Rated residual current	MCB tripping char.	Article No.	Type	Packing
6 A	30 mA	B	107619	Ex9BL-N 1P+N B6 30mA	1/6/72
10 A	30 mA	B	107620	Ex9BL-N 1P+N B10 30mA	1/6/72
13 A	30 mA	B	107621	Ex9BL-N 1P+N B13 30mA	1/6/72
16 A	30 mA	B	107622	Ex9BL-N 1P+N B16 30mA	1/6/72
20 A	30 mA	B	107623	Ex9BL-N 1P+N B20 30mA	1/6/72
25 A	30 mA	B	107624	Ex9BL-N 1P+N B25 30mA	1/6/72
32 A	30 mA	B	107625	Ex9BL-N 1P+N B32 30mA	1/6/72
40 A	30 mA	B	107626	Ex9BL-N 1P+N B40 30mA	1/6/72
6 A	100 mA	B	107651	Ex9BL-N 1P+N B6 100mA	1/6/72
10 A	100 mA	B	107652	Ex9BL-N 1P+N B10 100mA	1/6/72
13 A	100 mA	B	107653	Ex9BL-N 1P+N B13 100mA	1/6/72
16 A	100 mA	B	107654	Ex9BL-N 1P+N B16 100mA	1/6/72
20 A	100 mA	B	107655	Ex9BL-N 1P+N B20 100mA	1/6/72
25 A	100 mA	B	107656	Ex9BL-N 1P+N B25 100mA	1/6/72
32 A	100 mA	B	107657	Ex9BL-N 1P+N B32 100mA	1/6/72
40 A	100 mA	B	107658	Ex9BL-N 1P+N B40 100mA	1/6/72
6 A	300 mA	B	107683	Ex9BL-N 1P+N B6 300mA	1/6/72
10 A	300 mA	B	107684	Ex9BL-N 1P+N B10 300mA	1/6/72
13 A	300 mA	B	107685	Ex9BL-N 1P+N B13 300mA	1/6/72
16 A	300 mA	B	107686	Ex9BL-N 1P+N B16 300mA	1/6/72
20 A	300 mA	B	107687	Ex9BL-N 1P+N B20 300mA	1/6/72
25 A	300 mA	B	107688	Ex9BL-N 1P+N B25 300mA	1/6/72
32 A	300 mA	B	107689	Ex9BL-N 1P+N B32 300mA	1/6/72
40 A	300 mA	B	107690	Ex9BL-N 1P+N B40 300mA	1/6/72

RCBOs Ex9BL-N, 6 kA

AC type, characteristic C

- AC type of residual current circuit breaker sensitive on residual AC current
- C characteristic of installed circuit breaker
- Without time delay
- Surge current-proof 3000 A
- Suitable for protection of people in case of direct and indirect contact with live parts and exposed conductive parts during a fault, respectively
- Selective with upstream installed S or S+A type RCCB



Rated current	Rated residual current	MCB tripping char.	Article No.	Type	Packing
6 A	30 mA	C	107627	Ex9BL-N 1P+N C6 30mA	1/6/72
10 A	30 mA	C	107628	Ex9BL-N 1P+N C10 30mA	1/6/72
13 A	30 mA	C	107629	Ex9BL-N 1P+N C13 30mA	1/6/72
16 A	30 mA	C	107630	Ex9BL-N 1P+N C16 30mA	1/6/72
20 A	30 mA	C	107631	Ex9BL-N 1P+N C20 30mA	1/6/72
25 A	30 mA	C	107632	Ex9BL-N 1P+N C25 30mA	1/6/72
32 A	30 mA	C	107633	Ex9BL-N 1P+N C32 30mA	1/6/72
40 A	30 mA	C	107634	Ex9BL-N 1P+N C40 30mA	1/6/72
6 A	100 mA	C	107659	Ex9BL-N 1P+N C6 100mA	1/6/72
10 A	100 mA	C	107660	Ex9BL-N 1P+N C10 100mA	1/6/72
13 A	100 mA	C	107661	Ex9BL-N 1P+N C13 100mA	1/6/72
16 A	100 mA	C	107662	Ex9BL-N 1P+N C16 100mA	1/6/72
20 A	100 mA	C	107663	Ex9BL-N 1P+N C20 100mA	1/6/72
25 A	100 mA	C	107664	Ex9BL-N 1P+N C25 100mA	1/6/72
32 A	100 mA	C	107665	Ex9BL-N 1P+N C32 100mA	1/6/72
40 A	100 mA	C	107666	Ex9BL-N 1P+N C40 100mA	1/6/72
6 A	300 mA	C	107691	Ex9BL-N 1P+N C6 300mA	1/6/72
10 A	300 mA	C	107692	Ex9BL-N 1P+N C10 300mA	1/6/72
13 A	300 mA	C	107693	Ex9BL-N 1P+N C13 300mA	1/6/72
16 A	300 mA	C	107694	Ex9BL-N 1P+N C16 300mA	1/6/72
20 A	300 mA	C	107695	Ex9BL-N 1P+N C20 300mA	1/6/72
25 A	300 mA	C	107696	Ex9BL-N 1P+N C25 300mA	1/6/72
32 A	300 mA	C	107697	Ex9BL-N 1P+N C32 300mA	1/6/72
40 A	300 mA	C	107698	Ex9BL-N 1P+N C40 300mA	1/6/72

RCBOs Ex9BL-N, 6 kA

A type, characteristic B

- A type of residual current circuit breaker sensitive on residual AC and pulsating DC current
- B characteristic of installed circuit breaker
- Without time delay
- Surge current-proof 3000 A
- Suitable for protection of people in case of direct and indirect contact with live parts and exposed conductive parts during a fault, respectively
- Selective with upstream installed S or S+A type RCCB



Rated current	Rated residual current	MCB tripping char.	Article No.	Type	Packing
6 A	30 mA	B	107635	Ex9BL-N 1P+N B6 A 30mA	1/6/72
10 A	30 mA	B	107636	Ex9BL-N 1P+N B10 A 30mA	1/6/72
13 A	30 mA	B	107637	Ex9BL-N 1P+N B13 A 30mA	1/6/72
16 A	30 mA	B	107638	Ex9BL-N 1P+N B16 A 30mA	1/6/72
20 A	30 mA	B	107639	Ex9BL-N 1P+N B20 A 30mA	1/6/72
25 A	30 mA	B	107640	Ex9BL-N 1P+N B25 A 30mA	1/6/72
32 A	30 mA	B	107641	Ex9BL-N 1P+N B32 A 30mA	1/6/72
40 A	30 mA	B	107642	Ex9BL-N 1P+N B40 A 30mA	1/6/72
6 A	100 mA	B	107667	Ex9BL-N 1P+N B6 A 100mA	1/6/72
10 A	100 mA	B	107668	Ex9BL-N 1P+N B10 A 100mA	1/6/72
13 A	100 mA	B	107669	Ex9BL-N 1P+N B13 A 100mA	1/6/72
16 A	100 mA	B	107670	Ex9BL-N 1P+N B16 A 100mA	1/6/72
20 A	100 mA	B	107671	Ex9BL-N 1P+N B20 A 100mA	1/6/72
25 A	100 mA	B	107672	Ex9BL-N 1P+N B25 A 100mA	1/6/72
32 A	100 mA	B	107673	Ex9BL-N 1P+N B32 A 100mA	1/6/72
40 A	100 mA	B	107674	Ex9BL-N 1P+N B40 A 100mA	1/6/72
6 A	300 mA	B	107699	Ex9BL-N 1P+N B6 A 300mA	1/6/72
10 A	300 mA	B	107700	Ex9BL-N 1P+N B10 A 300mA	1/6/72
13 A	300 mA	B	107701	Ex9BL-N 1P+N B13 A 300mA	1/6/72
16 A	300 mA	B	107702	Ex9BL-N 1P+N B16 A 300mA	1/6/72
20 A	300 mA	B	107703	Ex9BL-N 1P+N B20 A 300mA	1/6/72
25 A	300 mA	B	107704	Ex9BL-N 1P+N B25 A 300mA	1/6/72
32 A	300 mA	B	107705	Ex9BL-N 1P+N B32 A 300mA	1/6/72
40 A	300 mA	B	107706	Ex9BL-N 1P+N B40 A 300mA	1/6/72

RCBOs Ex9BL-N, 6 kA

A type, characteristic C

- A type of residual current circuit breaker sensitive on residual pulsating AC current
- C characteristic of installed circuit breaker
- Without time delay
- Surge current-proof 3000 A
- Suitable for protection of people in case of direct and indirect contact with live parts and exposed conductive parts during a fault, respectively
- Selective with upstream installed S or S+A type RCCB



Rated current	Rated residual current	MCB tripping char.	Article No.	Type	Packing
6 A	30 mA	C	107643	Ex9BL-N 1P+N C6 A 30mA	1/6/72
10 A	30 mA	C	107644	Ex9BL-N 1P+N C10 A 30mA	1/6/72
13 A	30 mA	C	107645	Ex9BL-N 1P+N C13 A 30mA	1/6/72
16 A	30 mA	C	107646	Ex9BL-N 1P+N C16 A 30mA	1/6/72
20 A	30 mA	C	107647	Ex9BL-N 1P+N C20 A 30mA	1/6/72
25 A	30 mA	C	107648	Ex9BL-N 1P+N C25 A 30mA	1/6/72
32 A	30 mA	C	107649	Ex9BL-N 1P+N C32 A 30mA	1/6/72
40 A	30 mA	C	107650	Ex9BL-N 1P+N C40 A 30mA	1/6/72
6 A	100 mA	C	107675	Ex9BL-N 1P+N C6 A 100mA	1/6/72
10 A	100 mA	C	107676	Ex9BL-N 1P+N C10 A 100mA	1/6/72
13 A	100 mA	C	107677	Ex9BL-N 1P+N C13 A 100mA	1/6/72
16 A	100 mA	C	107678	Ex9BL-N 1P+N C16 A 100mA	1/6/72
20 A	100 mA	C	107679	Ex9BL-N 1P+N C20 A 100mA	1/6/72
25 A	100 mA	C	107680	Ex9BL-N 1P+N C25 A 100mA	1/6/72
32 A	100 mA	C	107681	Ex9BL-N 1P+N C32 A 100mA	1/6/72
40 A	100 mA	C	107682	Ex9BL-N 1P+N C40 A 100mA	1/6/72
6 A	300 mA	C	107707	Ex9BL-N 1P+N C6 A 300mA	1/6/72
10 A	300 mA	C	107708	Ex9BL-N 1P+N C10 A 300mA	1/6/72
13 A	300 mA	C	107709	Ex9BL-N 1P+N C13 A 300mA	1/6/72
16 A	300 mA	C	107710	Ex9BL-N 1P+N C16 A 300mA	1/6/72
20 A	300 mA	C	107711	Ex9BL-N 1P+N C20 A 300mA	1/6/72
25 A	300 mA	C	107712	Ex9BL-N 1P+N C25 A 300mA	1/6/72
32 A	300 mA	C	107713	Ex9BL-N 1P+N C32 A 300mA	1/6/72
40 A	300 mA	C	107714	Ex9BL-N 1P+N C40 A 300mA	1/6/72

Information sticker

- Sticker with information about regular monthly testing
- Languages EN, CZ, SK, FR, RU, PL, DE, RO
- In a scope of delivery of all magnetic RCCBs and RCBOs NOARK, spare part

Description	Languages	Article No.	Type	Packing
Information sticker	EN, CZ, SK, FR, RU, PL, DE, RO	101445	YS31	1

One-module RCBOs Ex9NLE, 6 kA



- One-module Residual Current circuit Breakers with Overload protection according to EN 61009-1
- Rated breaking capacity I_{cn} 6 kA
- 1P+N-pole version
- Rated residual current 30 mA
- Rated currents up to 40 A
- B and C tripping characteristics of integrated circuit breaker
- AC and A type of RCBO
- 1-module (18 mm) width
- Suitable for applications from -35 to +70°C

Voltage dependent Residual Current circuit Breakers with Overload protection Ex9NLE have only 1 module, so they can save one modular space in enclosure comparison to classical RCBO. They are based on electronic evaluation principle - more accurate measuring of residual current. These devices also do not suffer with magnetization of the tripping unit. Thus, there is no mandatory testing period, but they must be tested regularly. Local law or regulations may apply on utilization and testing period. The recommendation is to test it every 6 months in fair environment and every month in heavy condition.

The insulation test must be performed in the top terminals and with the device in the OFF position.

Type Key

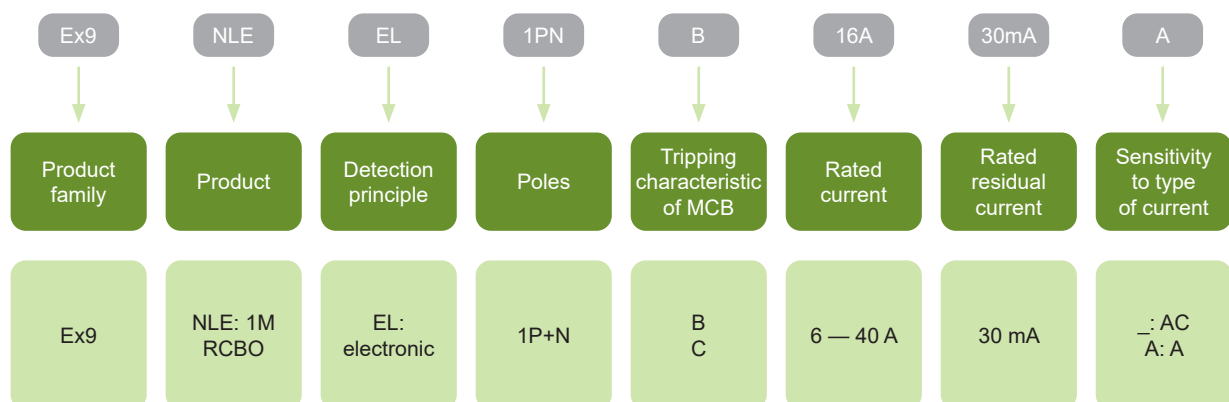

Certification marks



One-module RCBOs Ex9NLE, 6 kA

Accessories

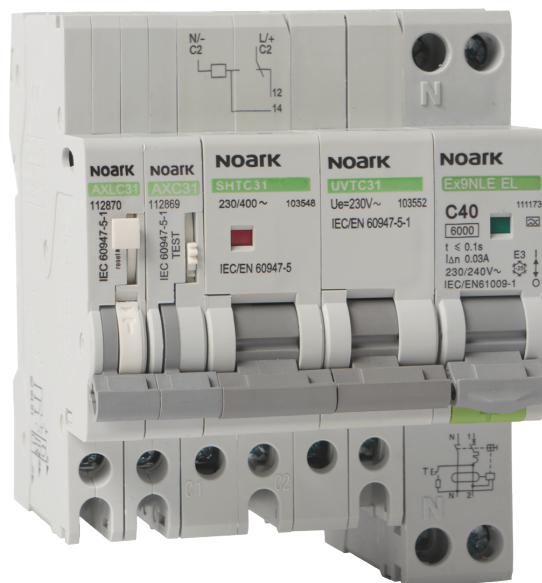

Auxiliary or signal contacts
AXC, AXLC
Up to 3 units

Voltage or trip releases
SHTC, UVTC
Up to 2 units

RCBO
Ex9NLE
1-module width

Auxiliary contact AXC31

Signal contact AXLC31

Shunt trip release SHTC31

Undervoltage releases UVTC31

see page 140

see page 140

see page 140

see page 140

All accessories are mounted to the Ex9NLE from the left side.

One-module RCBOs Ex9NLE, 6 kA

AC type, characteristic B

- AC type of residual current circuit breaker sensitive on residual AC current
- B characteristic of integrated circuit breaker
- Without time delay
- Surge current-proof 3000 A
- Suitable for protection of people in case of direct and indirect contact with live parts and exposed conductive parts during a fault, respectively



Rated current	Rated residual current	MCB tripping char.	Article No.	Type	Packing
6 A	30 mA	B	111146	Ex9NLE EL 1PN B6 30mA	1/12/144
10 A	30 mA	B	111147	Ex9NLE EL 1PN B10 30mA	1/12/144
16 A	30 mA	B	111148	Ex9NLE EL 1PN B16 30mA	1/12/144
20 A	30 mA	B	111149	Ex9NLE EL 1PN B20 30mA	1/12/144
25 A	30 mA	B	111150	Ex9NLE EL 1PN B25 30mA	1/12/144
32 A	30 mA	B	111151	Ex9NLE EL 1PN B32 30mA	1/12/144
40 A	30 mA	B	111152	Ex9NLE EL 1PN B40 30mA	1/12/144

AC type, characteristic C

- AC type of residual current circuit breaker sensitive on residual AC current
- C characteristic of integrated circuit breaker
- Without time delay
- Surge current-proof 3000 A
- Suitable for protection of people in case of direct and indirect contact with live parts and exposed conductive parts during a fault, respectively



Rated current	Rated residual current	MCB tripping char.	Article No.	Type	Packing
6 A	30 mA	C	111153	Ex9NLE EL 1PN C6 30mA	1/12/144
10 A	30 mA	C	111154	Ex9NLE EL 1PN C10 30mA	1/12/144
16 A	30 mA	C	111155	Ex9NLE EL 1PN C16 30mA	1/12/144
20 A	30 mA	C	111156	Ex9NLE EL 1PN C20 30mA	1/12/144
25 A	30 mA	C	111157	Ex9NLE EL 1PN C25 30mA	1/12/144
32 A	30 mA	C	111158	Ex9NLE EL 1PN C32 30mA	1/12/144
40 A	30 mA	C	111159	Ex9NLE EL 1PN C40 30mA	1/12/144

One-module RCBOs Ex9NLE, 6 kA

A type, characteristic B

- A type of residual current circuit breaker sensitive on residual AC and pulsating DC current
- B characteristic of integrated circuit breaker
- Without time delay
- Surge current-proof 3000 A
- Suitable for protection of people in case of direct and indirect contact with live parts and exposed conductive parts during a fault, respectively



Rated current	Rated residual current	MCB tripping char.	Article No.	Type	Packing
6 A	30 mA	B	111160	Ex9NLE EL 1PN B6 30mA A	1/12/144
10 A	30 mA	B	111161	Ex9NLE EL 1PN B10 30mA A	1/12/144
16 A	30 mA	B	111162	Ex9NLE EL 1PN B16 30mA A	1/12/144
20 A	30 mA	B	111163	Ex9NLE EL 1PN B20 30mA A	1/12/144
25 A	30 mA	B	111164	Ex9NLE EL 1PN B25 30mA A	1/12/144
32 A	30 mA	B	111165	Ex9NLE EL 1PN B32 30mA A	1/12/144
40 A	30 mA	B	111166	Ex9NLE EL 1PN B40 30mA A	1/12/144

A type, characteristic C

- A type of residual current circuit breaker sensitive on residual AC and pulsating DC current
- C characteristic of integrated circuit breaker
- Without time delay
- Surge current-proof 3000 A
- Suitable for protection of people in case of direct and indirect contact with live parts and exposed conductive parts during a fault, respectively



Rated current	Rated residual current	MCB tripping char.	Article No.	Type	Packing
6 A	30 mA	C	111167	Ex9NLE EL 1PN C6 30mA A	1/12/144
10 A	30 mA	C	111168	Ex9NLE EL 1PN C10 30mA A	1/12/144
16 A	30 mA	C	111169	Ex9NLE EL 1PN C16 30mA A	1/12/144
20 A	30 mA	C	111170	Ex9NLE EL 1PN C20 30mA A	1/12/144
25 A	30 mA	C	111171	Ex9NLE EL 1PN C25 30mA A	1/12/144
32 A	30 mA	C	111172	Ex9NLE EL 1PN C32 30mA A	1/12/144
40 A	30 mA	C	111173	Ex9NLE EL 1PN C40 30mA A	1/12/144

RCBOs Ex9NL-N 3P+N, 6 kA



- Residual Current circuit Breakers with Overload protection according to IEC / EN 61009-1
- Rated breaking capacity I_{cn} 6 kA
- 3+N-pole version
- Rated residual current 30, 300 mA
- Rated currents up to 40 A
- B and C tripping characteristics of installed circuit breaker
- AC and A type of RCD
- 4-module width
- Suitable for applications from -25 to +40°C

Ex9NL residual current circuit breakers are suitable for domestic as well as industrial applications. They are based on combination of residual current device with permanent magnet principle and circuit breaker with thermal overload release and magnetic short circuit current release. It brings the advantage of voltage independent function of the residual current device. Adequate voltage is only necessary when testing the RCBO with the T test button. Magnetic RCBOs should be tested regularly. Recommend is to test it every 6 months in fair environment and every month in heavy condition.

Type Key

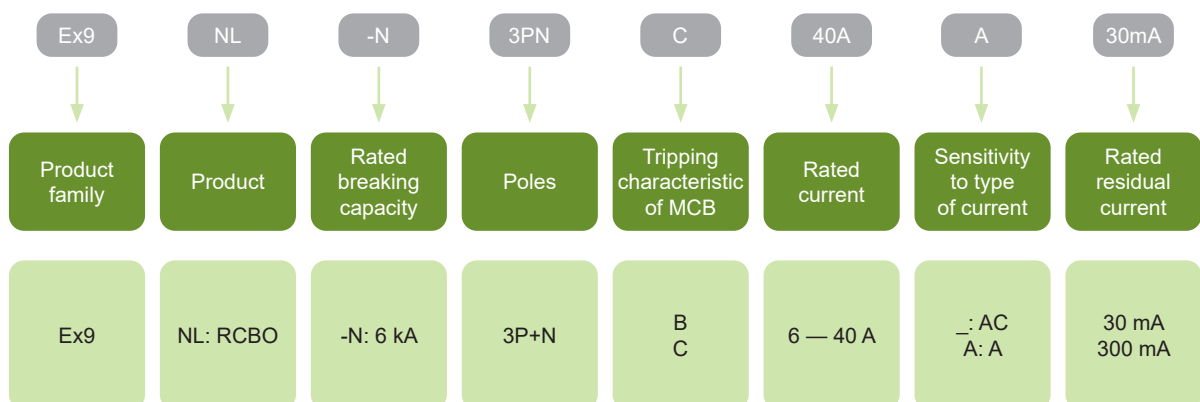

Certification marks



RCBOs Ex9NL-N 3P+N, 6 kA

Accessories

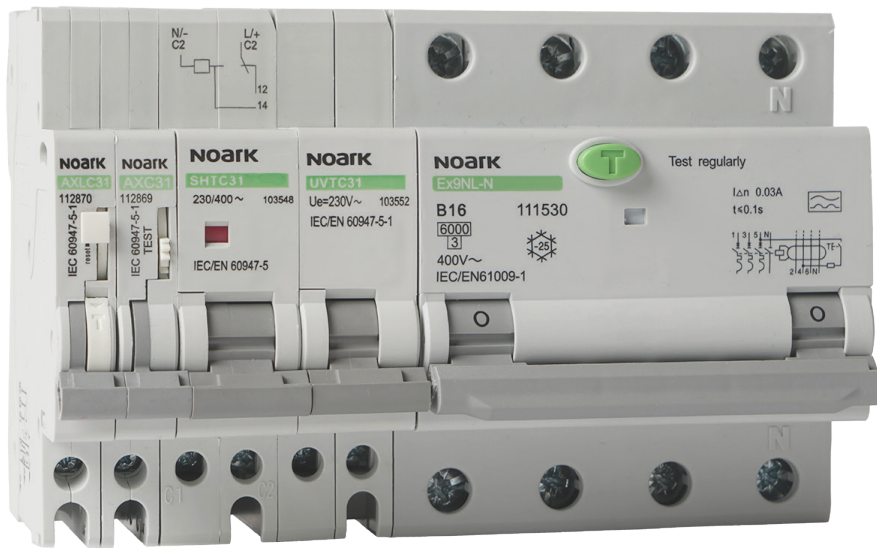

Auxiliary or signal contacts
AXC, AXLC
Up to 3 units

Voltage or trip releases
SHTC, UVTC
Up to 2 units

RCBO
Ex9NL-N
4-module width

Auxiliary contact AXC31

see page 140

Signal contact AXLC31

see page 140

Shunt trip release SHTC31

see page 140

Undervoltage releases UVTC31

see page 140

All accessories are mounted to the Ex9NL-N from the left side.

RCBOs Ex9NL-N 3P+N, 6 kA

AC type, characteristic B

- AC type of residual current circuit breaker sensitive on residual AC current
- B characteristic of installed circuit breaker
- Without time delay
- Suitable for protection of people in case of direct and indirect contact with live parts and exposed conductive part during a fault, respectively



Rated current	Rated residual current	MCB tripping char.	Article No.	Type	Packing
10A	30mA	B	111496	Ex9NL-N 3P+N B10 30mA	1/45
13A	30mA	B	111497	Ex9NL-N 3P+N B13 30mA	1/45
16A	30mA	B	111498	Ex9NL-N 3P+N B16 30mA	1/45
20A	30mA	B	111499	Ex9NL-N 3P+N B20 30mA	1/45
25A	30mA	B	111500	Ex9NL-N 3P+N B25 30mA	1/45
32A	30mA	B	111501	Ex9NL-N 3P+N B32 30mA	1/45
40A	30mA	B	111502	Ex9NL-N 3P+N B40 30mA	1/45
10A	300mA	B	111504	Ex9NL-N 3P+N B10 300mA	1/45
13A	300mA	B	111505	Ex9NL-N 3P+N B13 300mA	1/45
16A	300mA	B	111506	Ex9NL-N 3P+N B16 300mA	1/45
20A	300mA	B	111507	Ex9NL-N 3P+N B20 300mA	1/45
25A	300mA	B	111508	Ex9NL-N 3P+N B25 300mA	1/45
32A	300mA	B	111509	Ex9NL-N 3P+N B32 300mA	1/45
40A	300mA	B	111510	Ex9NL-N 3P+N B40 300mA	1/45

AC type, characteristic C

- AC type of residual current circuit breaker sensitive on residual AC current
- C characteristic of installed circuit breaker
- Without time delay
- Suitable for protection of people in case of direct and indirect contact with live parts and exposed conductive part during a fault, respectively



Rated current	Rated residual current	MCB tripping char.	Article No.	Type	Packing
6A	30mA	C	111511	Ex9NL-N 3P+N C6 30mA	1/45
10A	30mA	C	111512	Ex9NL-N 3P+N C10 30mA	1/45
13A	30mA	C	111513	Ex9NL-N 3P+N C13 30mA	1/45
16A	30mA	C	111514	Ex9NL-N 3P+N C16 30mA	1/45
20A	30mA	C	111515	Ex9NL-N 3P+N C20 30mA	1/45
25A	30mA	C	111516	Ex9NL-N 3P+N C25 30mA	1/45
32A	30mA	C	111517	Ex9NL-N 3P+N C32 30mA	1/45
40A	30mA	C	111518	Ex9NL-N 3P+N C40 30mA	1/45
6A	300mA	C	111519	Ex9NL-N 3P+N C6 300mA	1/45
10A	300mA	C	111520	Ex9NL-N 3P+N C10 300mA	1/45
13A	300mA	C	111521	Ex9NL-N 3P+N C13 300mA	1/45
16A	300mA	C	111522	Ex9NL-N 3P+N C16 300mA	1/45
20A	300mA	C	111523	Ex9NL-N 3P+N C20 300mA	1/45
25A	300mA	C	111524	Ex9NL-N 3P+N C25 300mA	1/45
32A	300mA	C	111525	Ex9NL-N 3P+N C32 300mA	1/45
40A	300mA	C	111526	Ex9NL-N 3P+N C40 300mA	1/45

RCBOs Ex9NL-N 3P+N, 6 kA

A type, characteristic B

- A type of residual current circuit breaker sensitive on residual AC and pulsating DC current
- B characteristic of installed circuit breaker
- Without time delay
- Suitable for protection of people in case of direct and indirect contact with live parts and exposed conductive part during a fault, respectively



Rated current	Rated residual current	MCB tripping char.	Article No.	Type	Packing
10A	30mA	B	111528	Ex9NL-N 3P+N B10 A 30mA	1/45
13A	30mA	B	111529	Ex9NL-N 3P+N B13 A 30mA	1/45
16A	30mA	B	111530	Ex9NL-N 3P+N B16 A 30mA	1/45
20A	30mA	B	111531	Ex9NL-N 3P+N B20 A 30mA	1/45
25A	30mA	B	111532	Ex9NL-N 3P+N B25 A 30mA	1/45
32A	30mA	B	111533	Ex9NL-N 3P+N B32 A 30mA	1/45
40A	30mA	B	111534	Ex9NL-N 3P+N B40 A 30mA	1/45
10A	300mA	B	111536	Ex9NL-N 3P+N B10 A 300mA	1/45
13A	300mA	B	111537	Ex9NL-N 3P+N B13 A 300mA	1/45
16A	300mA	B	111538	Ex9NL-N 3P+N B16 A 300mA	1/45
20A	300mA	B	111539	Ex9NL-N 3P+N B20 A 300mA	1/45
25A	300mA	B	111540	Ex9NL-N 3P+N B25 A 300mA	1/45
32A	300mA	B	111541	Ex9NL-N 3P+N B32 A 300mA	1/45
40A	300mA	B	111542	Ex9NL-N 3P+N B40 A 300mA	1/45

A type, characteristic C

- A type of residual current circuit breaker sensitive on residual AC and pulsating DC current
- C characteristic of installed circuit breaker
- Without time delay
- Suitable for protection of people in case of direct and indirect contact with live parts and exposed conductive part during a fault, respectively



Rated current	Rated residual current	MCB tripping char.	Article No.	Type	Packing
6A	30mA	C	111543	Ex9NL-N 3P+N C6 A 30mA	1/45
10A	30mA	C	111544	Ex9NL-N 3P+N C10 A 30mA	1/45
13A	30mA	C	111545	Ex9NL-N 3P+N C13 A 30mA	1/45
16A	30mA	C	111546	Ex9NL-N 3P+N C16 A 30mA	1/45
20A	30mA	C	111547	Ex9NL-N 3P+N C20 A 30mA	1/45
25A	30mA	C	111548	Ex9NL-N 3P+N C25 A 30mA	1/45
32A	30mA	C	111549	Ex9NL-N 3P+N C32 A 30mA	1/45
40A	30mA	C	111550	Ex9NL-N 3P+N C40 A 30mA	1/45
6A	300mA	C	111551	Ex9NL-N 3P+N C6 A 300mA	1/45
10A	300mA	C	111552	Ex9NL-N 3P+N C10 A 300mA	1/45
13A	300mA	C	111553	Ex9NL-N 3P+N C13 A 300mA	1/45
16A	300mA	C	111554	Ex9NL-N 3P+N C16 A 300mA	1/45
20A	300mA	C	111555	Ex9NL-N 3P+N C20 A 300mA	1/45
25A	300mA	C	111556	Ex9NL-N 3P+N C25 A 300mA	1/45
32A	300mA	C	111557	Ex9NL-N 3P+N C32 A 300mA	1/45
40A	300mA	C	111558	Ex9NL-N 3P+N C40 A 300mA	1/45

RCD add-on blocks Ex9LE



- Residual Current add-on blocks
- Tested according to IEC / EN 61009
- For combination with MCBs Ex9B
- Conditional rated short circuit strength I_{nc} 10 kA in combination with Ex9BH and 6 kA with Ex9BN
- 1+N up to 4-pole versions
- Rated residual current 10, 30, 100, 300 mA
- Rated currents up to 63 A
- Rated operational voltage 230/400 V AC
- AC type of RCD

Ex9LE residual current add-on blocks are suitable for domestic as well as industrial applications. They are based on electronic technology. It brings advantages of more accurate measuring of residual current and, as a consequence, reduction of unwanted tripping. (For possible use of this device, local legal requirements and conditions must be fulfilled.) These devices also do not suffer with magnetization of the tripping unit. Thus, regular testing is not necessary to preserve function of the device. To fulfill prescribed mandatory testing given by the product standard, it is recommended to test the device regularly with a period of one year.

Given pole version of the RCD add-on block must be combined with MCB of line Ex9B in the following way. 1+N-pole version of RCD add-on block is possible to combine with 1-pole MCB; 2-pole RCD block with 1+N or 2-pole MCB; 3-pole and 3+N-pole RCD block with 3-pole MCB, 4-pole RCD block with 3+N or 4-pole MCB. These variants enable to create very various combinations to obtain special devices with RCBO functionality.

Type Key

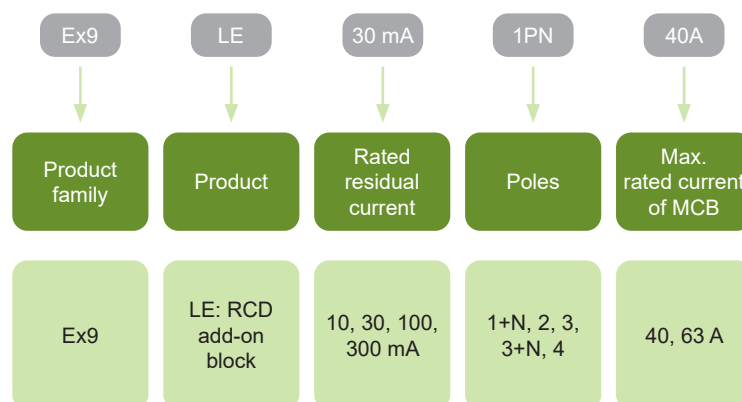

Certification marks



RCD add-on blocks Ex9LE

Mounting onto MCB



Aux. or signal contacts
AX, AL, AXL
Up to 3 units

Voltage or trip releases
SHT, UVT, OVT
Up to 2 units

MCB
Ex9B
1, 1+N, 2, 3, 3+N, 4-pole

RCD add-on block
Ex9LE
1+N, 2, 3, 3+N, 4-pole

RCD add-on blocks are mounted to the MCBs Ex9B from the right.

Use of other MCB accessories is not affected by installation of RCD add-on block anyhow.

Input voltage must be connected via MCB, other connection is not acceptable.

RCD add-on blocks Ex9LE

1+N-pole version

- AC type of residual current device sensitive on residual AC current
- Without time delay
- Surge current-proof 250 A
- 10 and 30 mA versions suitable for protection of people in case of direct and indirect contact with live parts and exposed conductive parts during a fault, respectively
- 100 and 300 mA versions suitable for protection against fire or as a protection against leakage currents (e.g. due to imperfect isolation)
- For combination with 1-pole version of MCB Ex9B



Rated residual current	Rated current	Poles	Article No.	Type	Packing
10 mA	40 A	1+N	100557	Ex9LE 10mA 1PN 40A	1/54
10 mA	63 A	1+N	100562	Ex9LE 10mA 1PN 63A	1/54
30 mA	40 A	1+N	100567	Ex9LE 30mA 1PN 40A	1/54
30 mA	63 A	1+N	100572	Ex9LE 30mA 1PN 63A	1/54
100 mA	40 A	1+N	100577	Ex9LE 100mA 1PN 40A	1/54
100 mA	63 A	1+N	100582	Ex9LE 100mA 1PN 63A	1/54
300 mA	40 A	1+N	100587	Ex9LE 300mA 1PN 40A	1/54
300 mA	63 A	1+N	100592	Ex9LE 300mA 1PN 63A	1/54

2-pole version

- AC type of residual current device sensitive on residual AC current
- Without time delay
- Surge current-proof 250 A
- 10 and 30 mA versions suitable for protection of people in case of direct and indirect contact with live parts and exposed conductive parts during a fault, respectively
- 100 and 300 mA versions suitable for protection against fire or as a protection against leakage currents (e.g. due to imperfect isolation)
- For combination with 1+N-pole or 2-pole version of MCB Ex9B



Rated residual current	Rated current	Poles	Article No.	Type	Packing
10 mA	40 A	2	100558	Ex9LE 10mA 2P 40A	1/45
10 mA	63 A	2	100563	Ex9LE 10mA 2P 63A	1/45
30 mA	40 A	2	100568	Ex9LE 30mA 2P 40A	1/45
30 mA	63 A	2	100573	Ex9LE 30mA 2P 63A	1/45
100 mA	40 A	2	100578	Ex9LE 100mA 2P 40A	1/45
100 mA	63 A	2	100583	Ex9LE 100mA 2P 63A	1/45
300 mA	40 A	2	100588	Ex9LE 300mA 2P 40A	1/45
300 mA	63 A	2	100593	Ex9LE 300mA 2P 63A	1/45

RCD add-on blocks Ex9LE

3-pole version

- AC type of residual current device sensitive on residual AC current
- Without time delay
- Surge current-proof 250 A
- 10 and 30 mA versions suitable for protection of people in case of direct and indirect contact with live parts and exposed conductive parts during a fault, respectively
- 100 and 300 mA versions suitable for protection against fire or as a protection against leakage currents (e.g. due to imperfect isolation)
- For combination with 3-pole version of MCB Ex9B



Rated residual current	Rated current	Poles	Article No.	Type	Packing
10 mA	40 A	3	100559	Ex9LE 10mA 3P 40A	1/27
10 mA	63 A	3	100564	Ex9LE 10mA 3P 63A	1/27
30 mA	40 A	3	100569	Ex9LE 30mA 3P 40A	1/27
30 mA	63 A	3	100574	Ex9LE 30mA 3P 63A	1/27
100 mA	40 A	3	100579	Ex9LE 100mA 3P 40A	1/27
100 mA	63 A	3	100584	Ex9LE 100mA 3P 63A	1/27
300 mA	40 A	3	100589	Ex9LE 300mA 3P 40A	1/27
300 mA	63 A	3	100594	Ex9LE 300mA 3P 63A	1/27

3+N-pole version

- AC type of residual current device sensitive on residual AC current
- Without time delay
- Surge current-proof 250 A
- 10 and 30 mA versions suitable for protection of people in case of direct and indirect contact with live parts and exposed conductive parts during a fault, respectively
- 100 and 300 mA versions suitable for protection against fire or as a protection against leakage currents (e.g. due to imperfect isolation)
- For combination with 3-pole version of MCB Ex9B



Rated residual current	Rated current	Poles	Article No.	Type	Packing
10 mA	40 A	3+N	100560	Ex9LE 10mA 3PN 40A	1/27
10 mA	63 A	3+N	100565	Ex9LE 10mA 3PN 63A	1/27
30 mA	40 A	3+N	100570	Ex9LE 30mA 3PN 40A	1/27
30 mA	63 A	3+N	100575	Ex9LE 30mA 3PN 63A	1/27
100 mA	40 A	3+N	100580	Ex9LE 100mA 3PN 40A	1/27
100 mA	63 A	3+N	100585	Ex9LE 100mA 3PN 63A	1/27
300 mA	40 A	3+N	100590	Ex9LE 300mA 3PN 40A	1/27
300 mA	63 A	3+N	100595	Ex9LE 300mA 3PN 63A	1/27

RCD add-on blocks Ex9LE

4-pole version

- AC type of residual current device sensitive on residual AC current
- Without time delay
- Surge current-proof 250 A
- 10 and 30 mA versions suitable for protection of people in case of direct and indirect contact with live parts and exposed conductive parts during a fault, respectively
- 100 and 300 mA versions suitable for protection against fire or as a protection against leakage currents (e.g. due to imperfect isolation)
- For combination with 3+N-pole or 4-pole version of MCB Ex9B



Rated residual current	Rated current	Poles	Article No.	Type	Packing
10 mA	40 A	4	100561	Ex9LE 10mA 4P 40A	1/24
10 mA	63 A	4	100566	Ex9LE 10mA 4P 63A	1/24
30 mA	40 A	4	100571	Ex9LE 30mA 4P 40A	1/24
30 mA	63 A	4	100576	Ex9LE 30mA 4P 63A	1/24
100 mA	40 A	4	100581	Ex9LE 100mA 4P 40A	1/24
100 mA	63 A	4	100586	Ex9LE 100mA 4P 63A	1/24
300 mA	40 A	4	100591	Ex9LE 300mA 4P 40A	1/24
300 mA	63 A	4	100596	Ex9LE 300mA 4P 63A	1/24

Notes

A large grid of dashed lines for taking notes, covering most of the page below the header.

Energy meters



Energy meters

Professional Tips

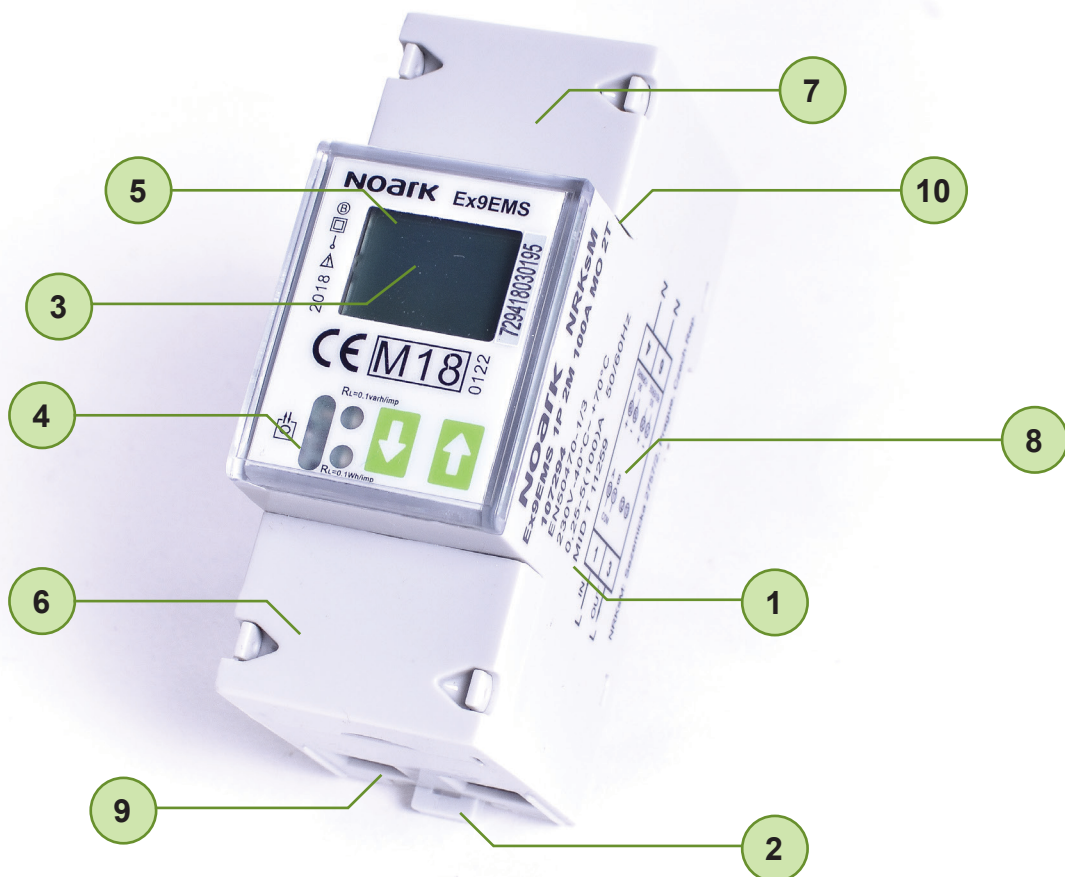

- 1 Important MID certification
- 2 Easy mounting on DIN rails in consumer units
- 3 Active and reactive energy
- 4 Programable by infrared eye
- 5 Separately countable forward and reverse energy = use for PV systems
- 6 Optional M-Bus or ModBus communication
- 7 S0 programmable output rate
- 8 Direct or indirect (CT) connection
- 9 1 or 3-phase types
- 10 1 or 2-tariff versions

Energy meters Ex9EM



- Basic Energy Meters according to EN 62052-11, EN 62053-21
- Mounting on DIN rails
- Operating voltage U_e 230/400 V AC
- Fixed rated current or adjustable by CT
- Multi-tariff or 1-tariff versions
- LCD or Mechanical register
- 1 or 4-module width versions

Energy Meters Ex9EM are basic meters of electric energy. We provide 6 types with various parameters. Rated current can be fixed or adjustable by Current Transformer. LCD or Mechanical register version is available.

Installation Energy Meters Ex9EM are suitable for residential and industrial applications. The biggest advantage is mounting on DIN rails inside consumer units. They will find their use everywhere where it is needed to count consumed energy.

Energy meters are offered in 1 or 4-modules width versions.

Ex9EM 1P 1M 80A MO MT as only one has Multi-tariff mode and RS485-ModBus communication which can read and display the following variables: kWh, active energy, reactive energy and active power. Software for communication can be downloaded from our website.

Type Key

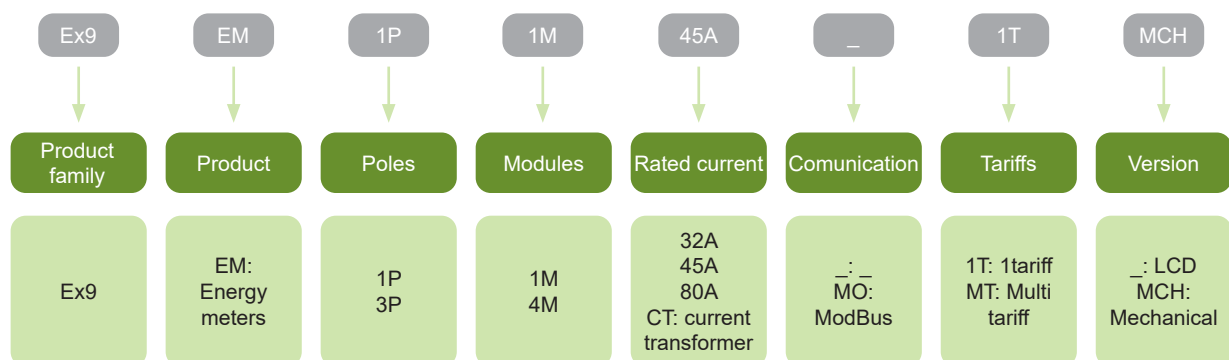

Certification marks



Energy Meters Ex9EM

Energy Meters

- Basic energy meters
- With LCD display or mechanical counter
- Fixed rated current or variable by Current Transformer
- Width 1MU or 4MU



Rated current	Poles	Modules	Article No.	Type	Packing
80A	1	1	107281	Ex9EM 1P 1M 80A MO MT	1/10/120
45A	1	1	107282	Ex9EM 1P 1M 45A 1T	1/10/120
45A	1	1	107283	Ex9EM 1P 1M 45A 1T MCH	1/10/120
CT	3	4	107284	Ex9EM 3P 4M CT 1T	1/1/45
80A	3	4	107285	Ex9EM 3P 4M 80A 1T	1/1/45
32A	1	1	107286	Ex9EM 1P 1M 32A 1T	1/10/120

Smart Energy Meters Ex9EMS



- Smart Energy Meters according to EN 50470-1/3
- MID certification
- Mounting on DIN rails
- Operating voltage U_e 230/400 V AC
- Fixed rated current or adjustable by CT
- 1 or 2-tariff versions
- LCD display
- Optional M-Bus or ModBus communication
- 1, 2 or 4-module width versions
- Infrared eye
- Software and hardware for IR communication

Energy Meters Ex9EMS are smart meters of electric energy. We provide wide range of types with various parameters. Rated current can be fixed or adjustable by Current Transformer. LCD display is a matter of course together with infrared eye for easy read out. Possibility of M-Bus or ModBus communication do from energy meters proper smart device.

Installation Smart Energy Meters Ex9EMS are suitable for residential and industrial applications. The biggest advantage is mounting on DIN rails inside consumer units. They will find their use everywhere where it is needed to count consumed energy.

We offer even cable for IR communication and software can be downloaded from our website.

Energy meters are offered in 1, 2 or 4-modules width versions.

Type Key

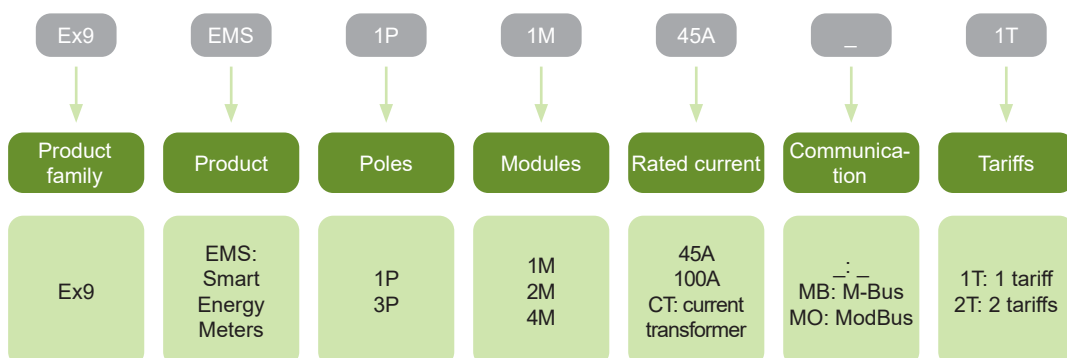

Certification marks



Smart Energy Meters Ex9EMS

Smart Energy Meters - 1 pole 1 module

- 1 or 2-tariff versions
- Optional M-Bus or ModBus communication
- Direct connection
- Width 1MU



Rated current	Communication	Article No.	Type	Packing
45A	-	107287	Ex9EMS 1P 1M 45A 1T	1/1/60
45A	-	107288	Ex9EMS 1P 1M 45A 2T	1/1/60
45A	M-Bus	107289	Ex9EMS 1P 1M 45A MB 2T	1/1/60
45A	ModBus	107290	Ex9EMS 1P 1M 45A MO 2T	1/1/60

Smart Energy Meters - 1 pole 2 modules

- 1 or 2-tariff versions
- Optional M-Bus or ModBus communication
- Direct connection
- Width 2MU



Rated current	Communication	Article No.	Type	Packing
100A	-	107291	Ex9EMS 1P 2M 100A 1T	1/1/48
100A	-	107292	Ex9EMS 1P 2M 100A 2T	1/1/48
100A	M-Bus	107293	Ex9EMS 1P 2M 100A MB 2T	1/1/48
100A	ModBus	107294	Ex9EMS 1P 2M 100A MO 2T	1/1/48

Smart Energy Meters - 3 poles 4 modules

- Optional M-Bus or ModBus communication
- Direct or CT connection
- Width 4MU



Rated current	Communication	Article No.	Type	Packing
100A	-	107295	Ex9EMS 3P 4M 100A 2T	1/1/36
100A	M-Bus	107296	Ex9EMS 3P 4M 100A MB 2T	1/1/36
100A	ModBus	107297	Ex9EMS 3P 4M 100A MO 2T	1/1/36
CT	-	107298	Ex9EMS 3P 4M CT 2T	1/1/36
CT	M-Bus	107299	Ex9EMS 3P 4M CT MB 2T	1/1/36
CT	ModBus	107300	Ex9EMS 3P 4M CT MO 2T	1/1/36

Smart Energy Meters Ex9EMS

IR connecting cable

- Infrared connecting cable with USB
- Magnetic connection with bracket to prevent movement
- Need to use a bracket



Description	Article No.	Type	Packing
IR connecting cable with USB	109855	IR USB	1

Bracket for IR cable

- Size depends on modular width of EMS energy meter



For energy meters	Article No.	Type	Packing
Ex9EMS 1P 1M	109856	IR BR 1M	1
Ex9EMS 1P 2M	109857	IR BR 2M	1
Ex9EMS 3P 4M	109858	IR BR 4M	1

Current Transformers CT



- Split core or solid core
- Primary current up to 1 000A

We offers wide range of solid core and split core current transformers. Their purpose is in measuring primary currents and produce a proportional secondary current signal. They are perfectly suitable for installation in combination with a Ex9EMS 3P 4M CT smart energy meters and Ex9EM 3P 4M CT 1T energy meter.

Split core CTs are designed for installation into existing plants where removal of busbars/cable lugs prevent installation of standard current transformers.

Type Key

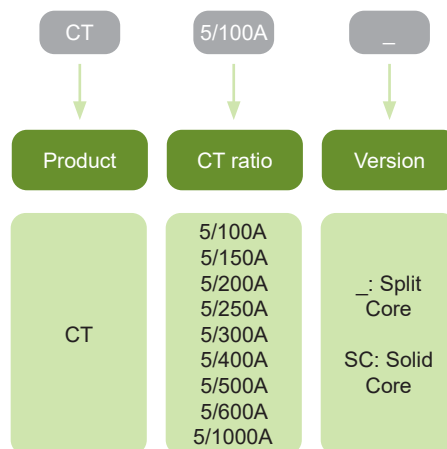

Certification marks



Current Transformers CT

Current transformers - Solid core

- Primary current up to 1000A



Ratio	Article No.	Type	Packing
5/100A	107301	CT 5/100A SC	1/1/100
5/150A	107302	CT 5/150A SC	1/1/100
5/200A	107303	CT 5/200A SC	1/1/100
5/250A	107304	CT 5/250A SC	1/1/100
5/300A	107305	CT 5/300A SC	1/1/100
5/400A	107306	CT 5/400A SC	1/1/60
5/500A	107307	CT 5/500A SC	1/1/60
5/600A	107308	CT 5/600A SC	1/1/60
5/1000A	107309	CT 5/1000A SC	1/1/30

Current transformers - Split core

- Primary current up to 600A
- Possibility of installation into existing bushbars/cables



Ratio	Article No.	Type	Packing
5/100A	107310	CT 5/100A	1/1/48
5/150A	107311	CT 5/150A	1/1/48
5/200A	107312	CT 5/200A	1/1/48
5/250A	107313	CT 5/250A	1/1/48
5/300A	107314	CT 5/300A	1/1/48
5/400A	107315	CT 5/400A	1/1/39
5/600A	107316	CT 5/600A	1/1/39

Notes

A large grid of dashed lines for taking notes, covering most of the page.

Motor Protective Circuit Breakers

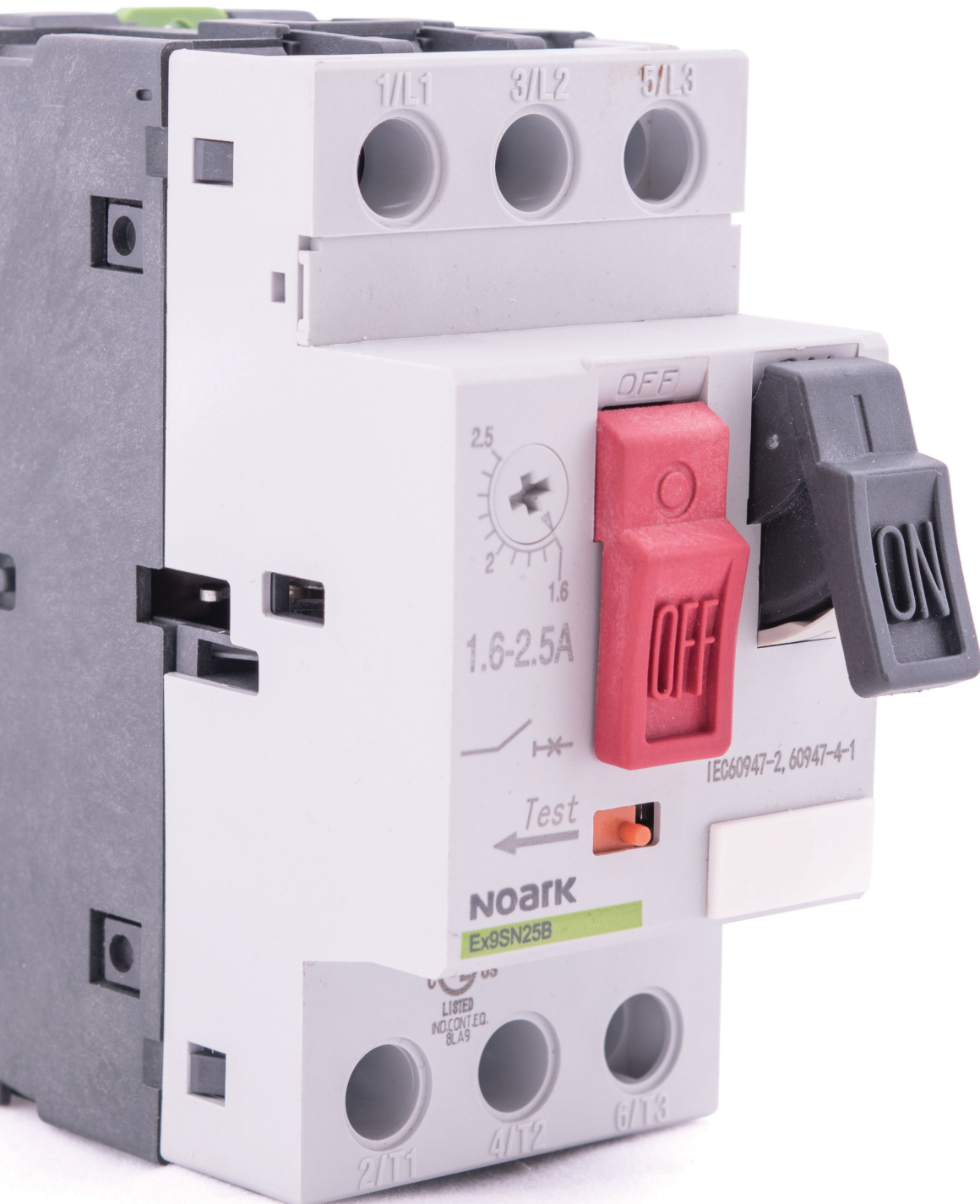

Motor protective circuit breakers

Professional Tips

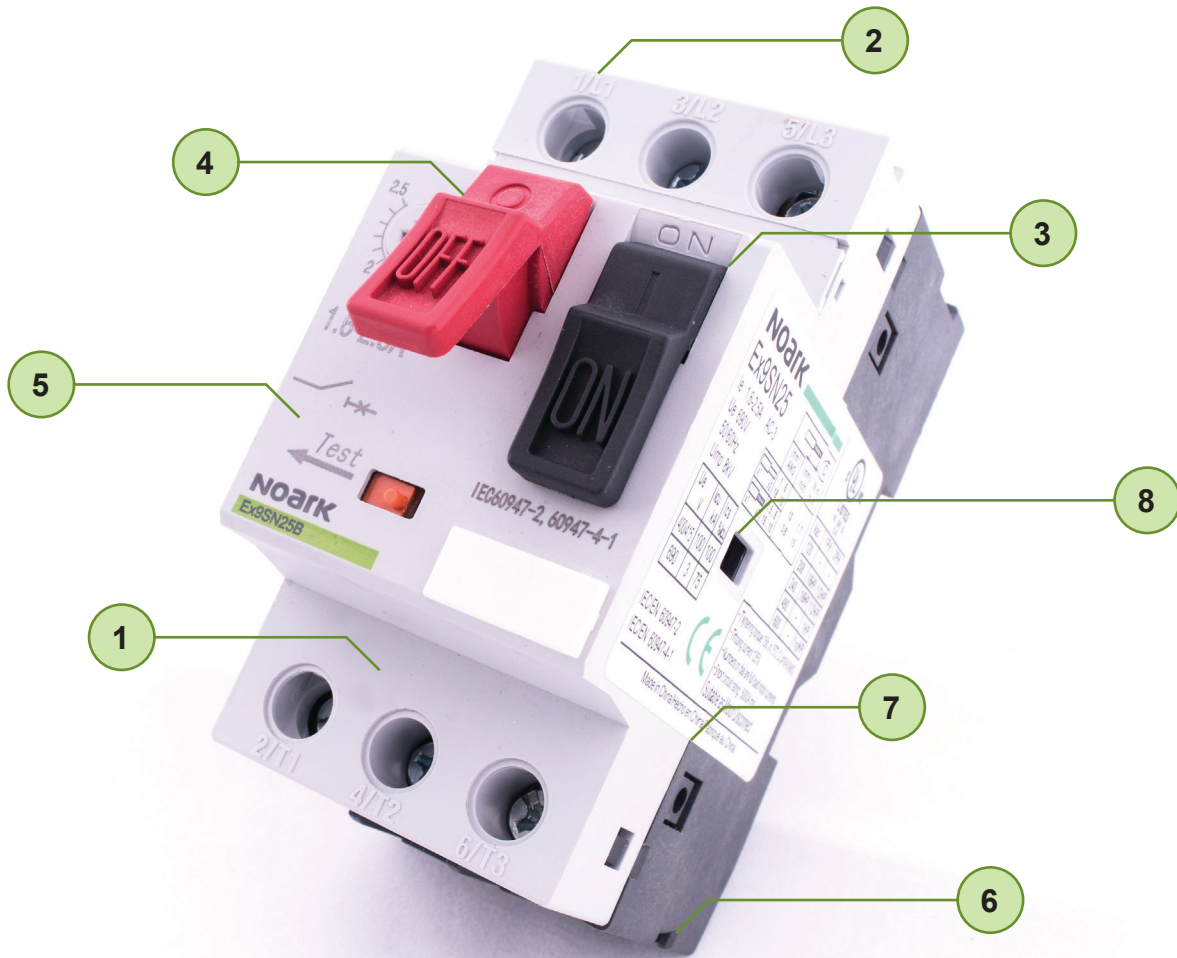

- 1 5 year warranty
- 2 Suitable for 1-phase as well 3-phase circuits
- 3 Rated current up to 25 A
- 4 Protection against overload, short circuit and phase-loss
- 5 Compact dimensions
- 6 Easy mounting on DIN rail
- 7 Suitable for residential distribution boards
- 8 Wide range of accessories

Motor protective circuit breakers Ex9SN25B



- Manual motor protective circuit breakers
- Meet requirements of EN 60947-2 and EN 60947-4-1
- Rated current I_n up to 25 A at 415 V AC-3
- Rated operating voltage U_n up to 400/415 V
- Short-circuit protection
- Disconnect function
 - Overload protection
 - Loss-phase protection
- Suitable for three and single-phase applications
- Wide range of accessories

Manual motor starters are electromechanical protection devices for the main circuit. They are used mainly to switch motors manually ON/OFF and protect them fuseless against short circuit and loss-phase.

Fuseless protection with a manual motor starter saves costs, space and ensures a quick reaction under short-circuit condition, by switching off the motor within milliseconds.

Manual motor starter combinations are setup together with contactors and overload relays.

Type Key

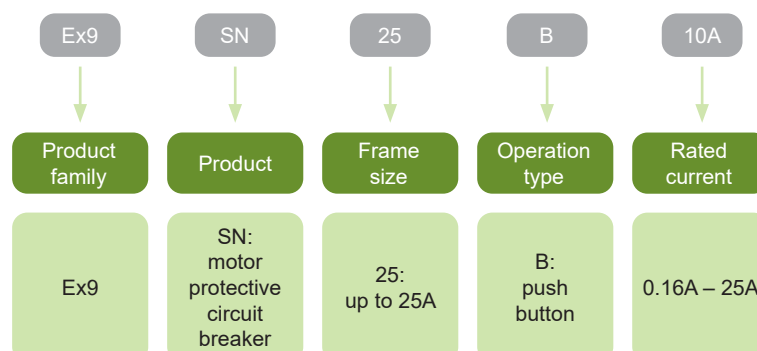

Certification marks



Motor protective circuit breakers Ex9SN25B

Accessories

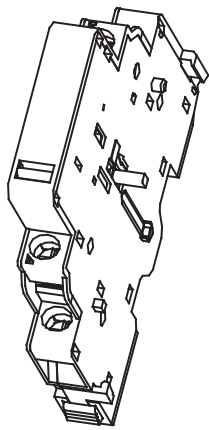

Side-mounted auxiliary contact
ASNA
Up to 2 units

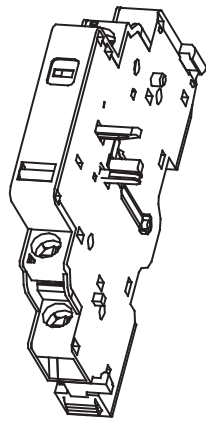

Alarm contact
ASNF
Up to 1 unit

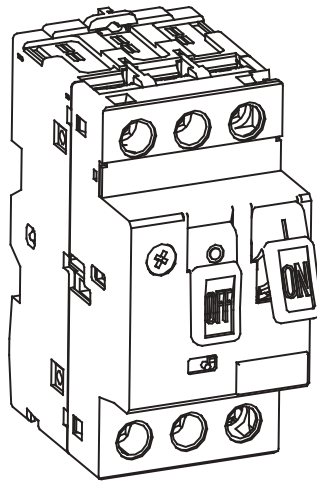

Motor protective circuit breaker
Ex9SN25B

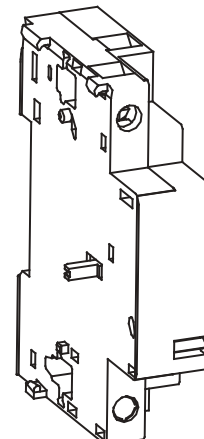

Voltage releases
ASNT or ASNUV
Up to 1 unit

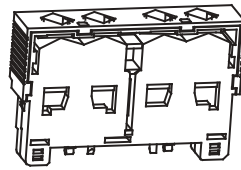

Front-mounted auxiliary contact
ASNB
Up to 1 unit

Auxiliary contacts ASNA

see page 136

Auxiliary contacts ASNB

see page 136

Alarm contact ASNF

see page 136

Shunt trip release ASNT

see page 137

Undervoltage release ASNUV

see page 134

Isolated boxes for surface mounting ASNE

see page 134

Motor protective circuit breakers Ex9SN25B

Motor protective circuit breakers, 3-pole

- Adjustable overload protection I_r
- Fixed instantaneous short-circuit current protection I_i (ca. $11 - 14 \times I_n$)
- Temperature compensation function to reduce the impact of ambient temperature



Rated current I_n	Tripping current setting range I_r	Short-circuit current I_i	Article No.	Type	Packing
0.16 A	0.10 – 0.16 A	1.5 A	108940	Ex9SN25B 0.16A	1/64
0.25 A	0.16 – 0.25 A	2.4 A	108941	Ex9SN25B 0.25A	1/64
0.40 A	0.25 – 0.40 A	5 A	108942	Ex9SN25B 0.4A	1/64
0.63 A	0.40 – 0.63 A	8 A	108943	Ex9SN25B 0.63A	1/64
1.0 A	0.63 – 1.00 A	13 A	108944	Ex9SN25B 1A	1/64
1.6 A	1.0 – 1.6 A	22.5 A	108945	Ex9SN25B 1.6A	1/64
2.5 A	1.6 – 2.5 A	33.5 A	108946	Ex9SN25B 2.5A	1/64
4.0 A	2.5 – 4.0 A	51 A	108947	Ex9SN25B 4A	1/64
6.3 A	4.0 – 6.3 A	78 A	108948	Ex9SN25B 6.3A	1/64
10 A	6.0 – 10 A	138 A	108949	Ex9SN25B 10A	1/64
14 A	9.0 – 14 A	170 A	108950	Ex9SN25B 14A	1/64
18 A	13 – 18 A	223 A	108951	Ex9SN25B 18A	1/64
23 A	17 – 23 A	327 A	108952	Ex9SN25B 23A	1/64
25 A	20 – 25 A	327 A	108953	Ex9SN25B 25A	1/64

Notes

A large grid of dashed lines for taking notes, covering most of the page area below the header.

Accessories for installation devices

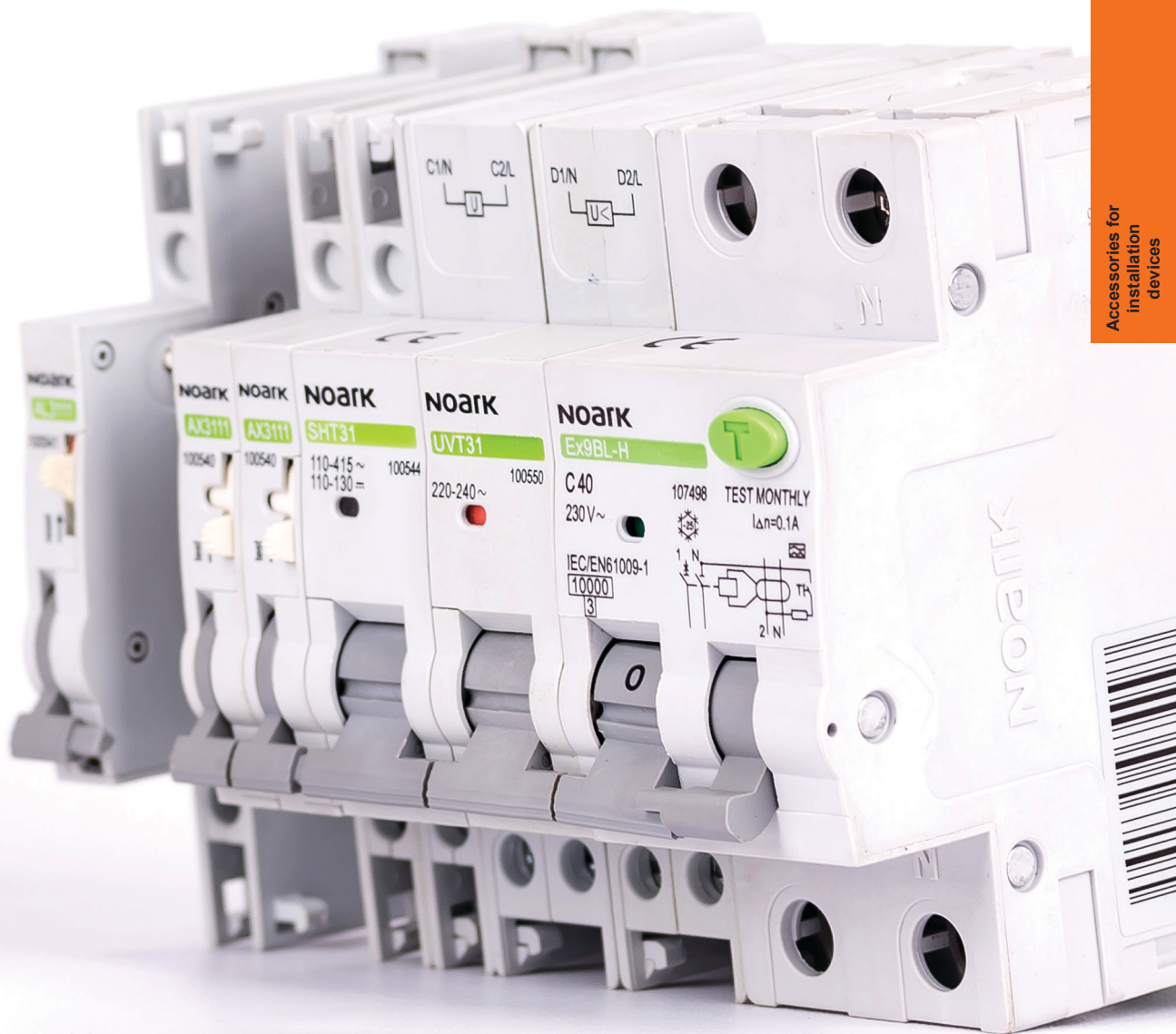

Accessories for installation devices

Professional Tips

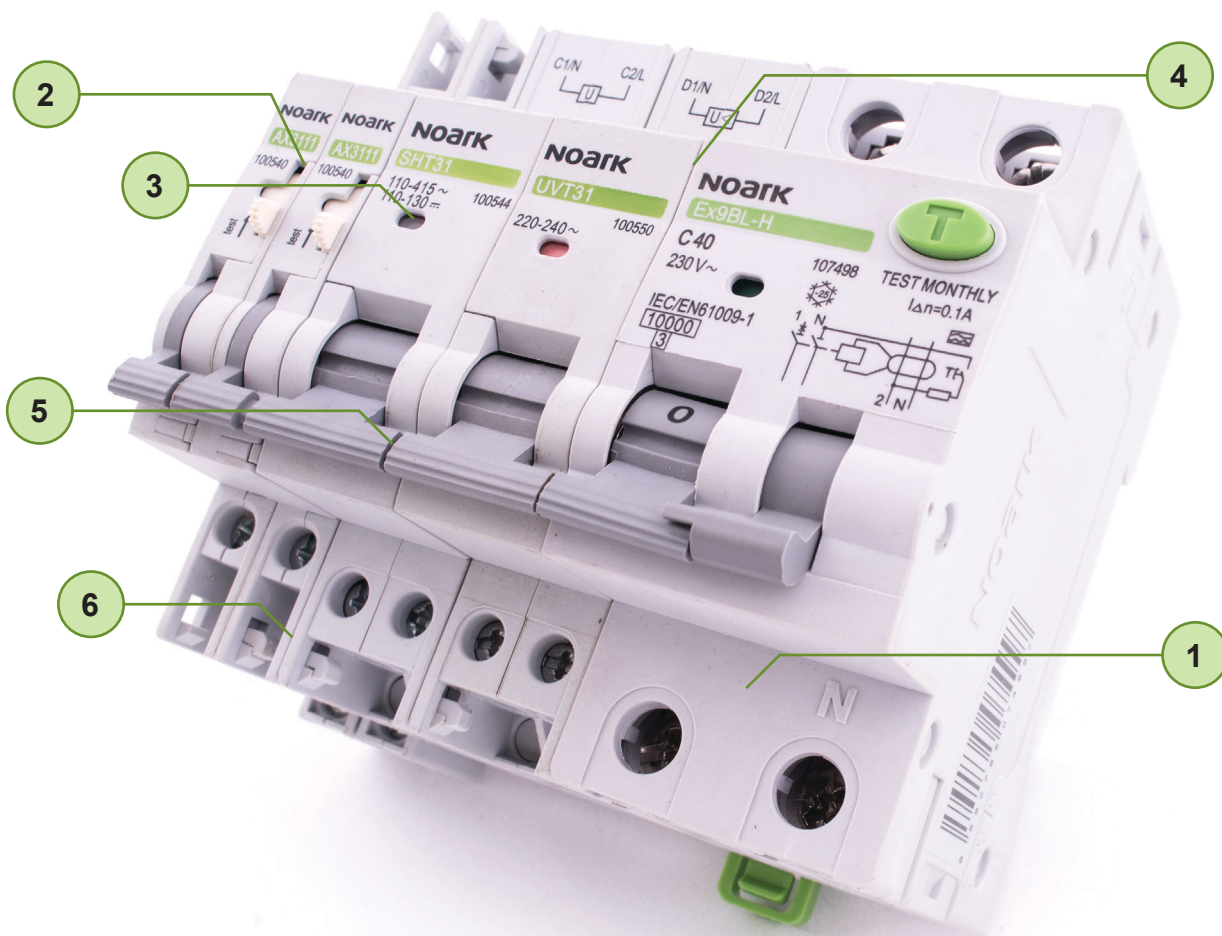

1 5 year warranty

2 Test switch on signal contact units

3 Contact state indication in voltage releases

4 Compatible with NOARK devices line up

5 Easy mounting

6 Robust construction

Accessories for Ex9B and Ex9PN



- Accessories for installation devices Ex9B (Ex9BH, Ex9BN, Ex9B125, Ex9BD, Ex9BP, Ex9BL), Ex9PN, Ex9BI, Ex9IP
- Auxiliary contacts synchronous with main contacts of the device
- Signal contacts active on electrical tripping of the circuit breaker
- Shunt trip releases
- Locking devices
- Undervoltage releases
- Overvoltage release
- According to IEC/EN 60947-1 and IEC/EN 60947-5-1

Accessories are designed in the way to be possible to combine different types with one installation device. It can be used up to two releases plus up to three units of auxiliary or signal contacts (two units in case of AX3122 with two pairs of contacts) plus one unit of RCD-block (only for Ex9B MCBs).

Release units are mounted from the left to the installation device.

Auxiliary and signal contact units must be mounted from the left to the device or to the release unit(s) when installed. Contact units are equipped with changeover (CO) combination(s) of contacts.

Type Key

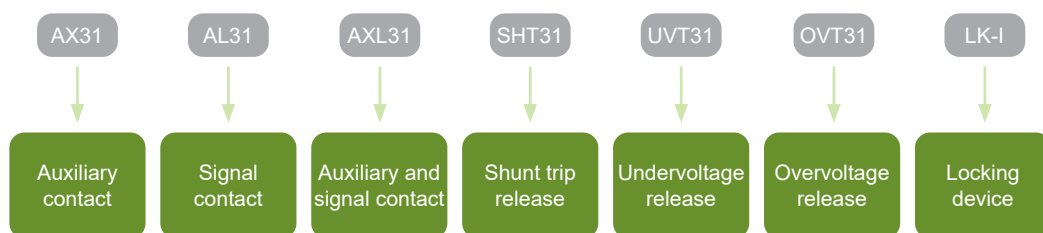

Accessories for Ex9B and Ex9PN

Auxiliary and signal contact units



Function	Contacts	Article No.	Type	Packing
Auxiliary	1 CO	100540	AX3111	1/96
Auxiliary	2 CO	100542	AX3122	1/96
Signal	1 CO	100541	AL3111	1/96
Auxiliary + signal	1 CO + 1 CO	100543	AXL31	1/96

Wiring diagrams

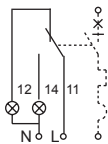

AX3111

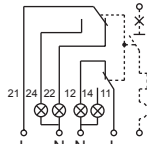

AX3122

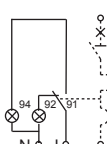

AL3111

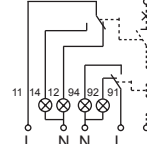

AXL31

Technical data p. 278

Shunt trip releases



Aux. cont.	AC Op. Volt.	DC Op. Volt.	Article No.	Type	Packing
-	110 — 415	110 — 130	100544	SHT31 110V-415V AC/110V-130V DC	1/96
-	48	48	100545	SHT31 48V AC/DC	1/96
-	12 — 24	12 — 24	100546	SHT31 12-24V AC/DC	1/96
1 CO	110 — 415	110 — 130	100547	SHT3111 110V-415V AC/110V-130V DC	1/96
1 CO	48	48	100548	SHT3111 48V AC/DC	1/96
1 CO	12 — 24	12 — 24	100549	SHT3111 12-24V AC/DC	1/96

Wiring diagrams

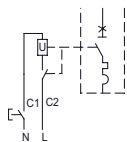

SHT31

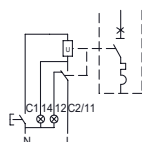

SHT3111

Technical data p. 280

Locking devices

- Possibility of locking installation devices in ON or OFF position
- Suitable for devices - Ex9BH, Ex9BN, Ex9BD, Ex9BP, Ex9BL, Ex9BI, Ex9PN, Ex9IP, Ex9I125, Ex9I40, Ex9BT, SHT31, UVT31, OVT31
- Padlock is not included



Function	Article No.	Type	Packing
Locking by padlock	110193	LK-I	1/16/240

Technical data p. 278

Accessories for Ex9B and Ex9PN

Undervoltage releases



Aux. cont.	AC Op. Volt.	DC Op. Volt.	Article No.	Type	Packing
-	220 — 240	-	100550	UVT31 220-240V AC	1/96
-	48	48	100551	UVT31 48V AC/DC	1/96
1 NC	220 — 240	-	100552	UVT3101 220-240V AC	1/96
1 NC	48	48	100553	UVT3101 48V AC/DC	1/96
1 NO	220 — 240	-	100554	UVT3110 220-240V AC	1/96
1 NO	48	48	100555	UVT3110 48V AC/DC	1/96

Wiring diagrams

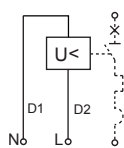

UVT31

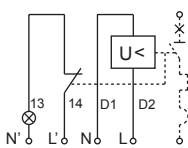

UVT3101

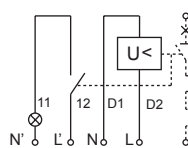

UVT3110

Technical data p. 282

Overvoltage releases

- Overvoltage release is not a protection against transient overvoltage and does not supersede surge protection devices



Aux. cont.	AC Op. Volt.	DC Op. Volt.	Article No.	Type	Packing
-	280V AC±5%	-	100556	OVT31 280V AC±5%	1/96

Wiring diagram

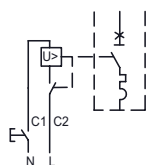

OVT31

Technical data p. 284

Technical data p. 278

Notes

A large grid of dashed lines for taking notes, covering most of the page area below the header.

Accessories for Ex9SN25B



- Accessories for motor protective circuit breakers Ex9SN25B
- Front-mounted auxiliary contacts ASNB
- Side-mounted auxiliary contacts ASNA
- Side-mounted alarm contact ASNF
- Undervoltage release ASNUV
- Shunt trip release ASNT
- Isolated boxes for surface mounting

Ex9SN25B motor protective circuit breakers can be equipped with various types of additional accessories. All the accessories are designed in the way to be possible to combine different types with one device. There can be used up to three auxiliary or alarm contact units plus one voltage release.

Auxiliary contact units are available with three possible contact combinations. Auxiliary and alarm contact units are mounted from the left to the device. Release units are mounted from the right side. Installation of an auxiliary or alarm contact units does not affect the possibility of installing voltage release.

Type Key

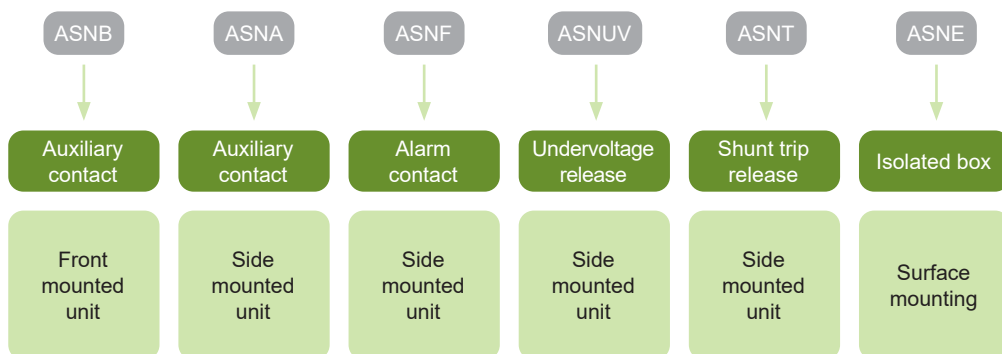

Accessories for Ex9SN25B

Auxiliary contacts for Ex9SN25B, front-mounted



Contacts	Suitable for	Article No.	Type	Packing
2 NO	Ex9SN25B	108956	ASNB20	20/1280
1 NO + 1 NC	Ex9SN25B	108957	ASNB11	20/1280

Technical data p. 286

Auxiliary contacts for Ex9SN25B, side-mounted



Contacts	Suitable for	Article No.	Type	Packing
2 NO	Ex9SN25B	108954	ASNA20	4/256
1 NO + 1 NC	Ex9SN25B	108955	ASNA11	4/256

Technical data p. 287

Alarm contacts for Ex9SN25B, side-mounted



Contacts	Suitable for	Article No.	Type	Packing
1 NO (Fault) + 1 NC (Aux)	Ex9SN25B	108964	ASNF1001	3/192
1 NC (Fault) + 1 NC (Aux)	Ex9SN25B	108965	ASNF0101	3/192
1 NO (Fault) + 1 NO (Aux)	Ex9SN25B	108966	ASNF1010	3/192
1 NC (Fault) + 1 NO (Aux)	Ex9SN25B	108967	ASNF0110	3/192

Technical data p. 286

Accessories for Ex9SN25B

Undervoltage releases for Ex9SN25B, side-mounted



AC operating voltage	Suitable for	Article No.	Type	Packing
110-115V 50Hz/127V 60Hz	Ex9SN25B	108958	ASNUVA	2/128
220-240V 50Hz	Ex9SN25B	108959	ASNUVB	2/128
380-400V 50Hz/ 440V 60Hz	Ex9SN25B	108960	ASNUVC	2/128

Technical data p. 290

Shunt trip releases for Ex9SN25B, side-mounted



AC operating voltage	Suitable for	Article No.	Type	Packing
110-115V 50Hz/127V 60Hz	Ex9SN25B	108961	ASNTA	2/128
220-240V 50Hz	Ex9SN25B	108962	ASNTB	2/128
380-400V 50Hz/ 440V 60Hz	Ex9SN25B	108963	ASNTC	2/128

Technical data p. 289

Isolated boxes for Ex9SN25B, surface mounting



Description	Suitable for	Article No.	Type	Packing
Actuating diaphragm	Ex9SN25B	108968	ASNEA	1/20
Emergency stop pushbutton	Ex9SN25B	108969	ASNEB	1/12

Technical data p. 291

Technical data p. 286

Notes

A large grid of dashed lines for taking notes, covering most of the page below the 'Notes' header.

Accessories for Ex9NL-N and Ex9NLE



- Accessories for Residual Circuit Breakers with Overcurrent protection Ex9NL-N and Ex9NLE
- Auxiliary contacts synchronous with main contacts of the device
- Signal contacts active on electrical tripping of the circuit breaker
- Shunt trip releases
- Undervoltage releases
- According to IEC/EN 60947-5-1

Accessories are designed in the way to be possible to combine different types with one installation device. It can be used up to two releases plus up to three units of auxiliary or signal contacts

Shunt trip release SHTC31 can be used for remote switch off function, undervoltage release UVTC31 to switch connected device off in case of voltage drop.

Auxiliary and signal contact units must be mounted from the left to the device or to the release unit(s) when installed. Contact units are equipped with 1 changeover contact (CO).

Type Key

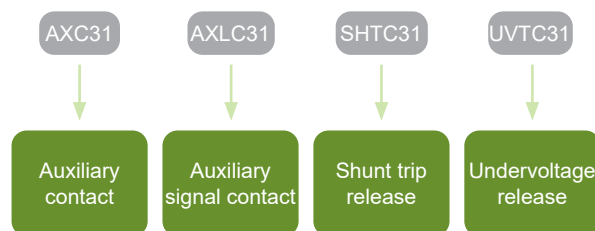

Accessories for Ex9NL-N and Ex9NLE

Auxiliary and signal contact units



Function	Contacts	Article No.	Type	Packing
Auxiliary	1 CO	112869	AXC31 11	12/180
Signal	1 CO	112870	AXLC31 11	12/180

Wiring diagrams

Technical data p. 292



AXC31 / AXLC31

Shunt trip releases



Aux. cont.	AC Op. Volt.	DC Op. Volt.	Article No.	Type	Packing
-	230/400	-	103548	SHTC31 230/400V AC	1/135
-	48	48	112871	SHTC31 48V AC/DC	1/135
-	24	24	112872	SHTC31 24V AC/DC	1/135

Wiring diagrams

Technical data p. 294

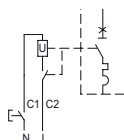

SHTC31

Undervoltage releases



Aux. cont.	AC Op. Volt.	DC Op. Volt.	Article No.	Type	Packing
-	230V	-	103552	UVTC31 230V AC	1/135

Wiring diagrams

Technical data p. 296

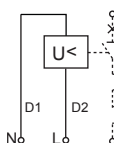

UVTC31

Technical data p. 292

Surge Protection Devices



Surge Protection Devices

Professional Tips

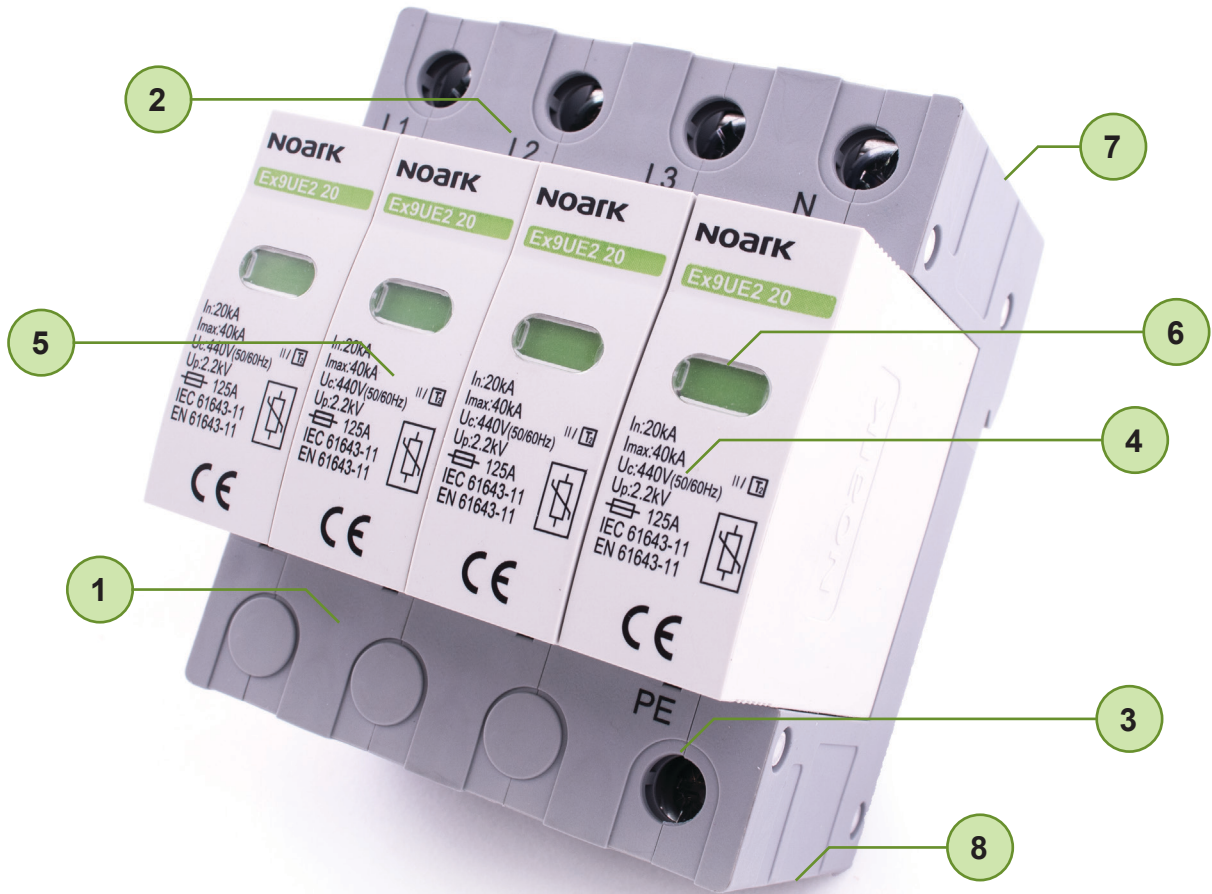

- 1 5 year warranty
- 2 Complete range of SPDs 1+2, 2, 3
- 3 Connection modes X+0 and X+1
- 4 Max. continuous voltage 275 to 440 V AC
- 5 Plug-in module design
- 6 Device status indicator on front side
- 7 Variants with alarm contact available
- 8 Easy mounting on DIN rail

Surge Protection Devices Ex9UE1+2, 25 kA



- Surge Protection Devices
- Type 1+2 (Class I+II, T1+T2, B+C)
- Tested according to EN 61643-11
- Max. impulse current I_{imp} 25 kA (10/350 μ s) per module and 100 kA for NPE module
- Maximum continuous operational voltage U_c 280 V AC
- Versions with 3+0, 3+1 and 4+0 connection
- Plug-in module design
- With and without remote indication contact
- Device status indicator

The Ex9UE1+2 25 line is a group of Class I+II Surge Protective Devices. They are intended as a protection against direct hit of lightning strokes of medium intensities. In standard three phase TN-C grid, they provides protection up to LPL I, II requirements given in EN 62305 with total lightning current introduced into electrical installation of 75 kA and total lightning stroke current 150 or 200 kA based on physical configuration and mutual position of grounding point of lightning rod, grounding point of the electrical installation and place of SPD installation.

The design of Ex9UE1+2 25 is hybrid based on combination of high energy Metal Oxide Varistors and isolation Spark Gap. This combination brings lower response time thanks to fast MOV and low voltage SG in comparison to a pure SG solution. The serial connection of MOV provides limitation of follow current characteristics for SG, but also full isolation due to serial connection of SG to MOV.

The main characteristics are defined by MOV part dominantly. Resulting protection level and response characteristics not only fulfill requirements of class I SPDs but also for class II ones. Ex9UE1+2 25 provides protection for both classes I and II. The modular design with plug in inserts allows simple and quick replacement of function modules in case of MOV is beyond if its lifespan due to high intensity or often occurrence of overvoltage peaks.

Type Key

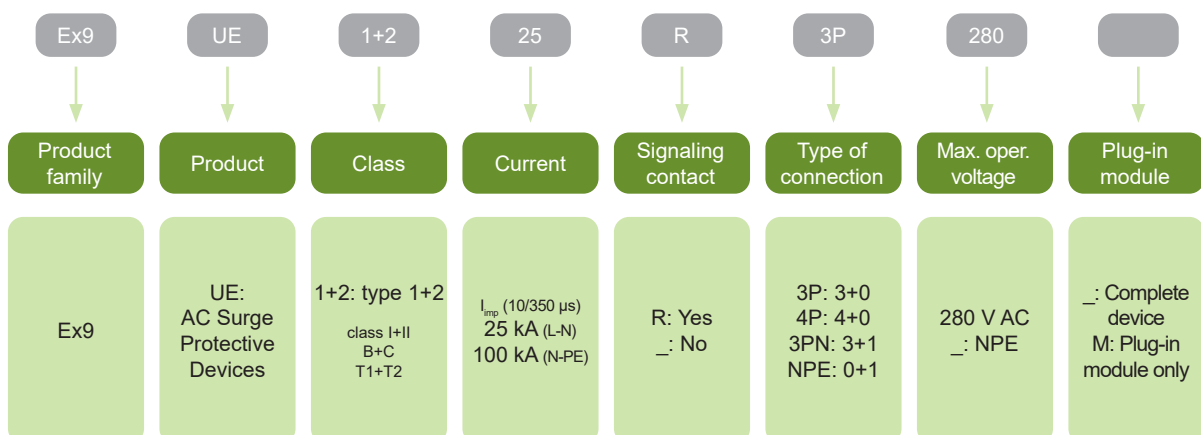

Certification marks



Surge Protection Devices Ex9UE1+2

Type 1+2 SPDs (Class I+II, T1+T2, B+C) complete devices, $I_{imp} = 25 \text{ kA (10/350 } \mu\text{s)}$

- Maximum impulse current I_{imp} 25 kA (10/350 μs) per module and 100 kA (10/350 μs) for NPE (+1) module
- Nominal discharge current I_n 25 kA (8/20 μs) per module and 100 kA (8/20 μs) for NPE (+1) module
- Maximum discharge current I_{max} 60 kA (8/20 μs) per module and 100 kA (8/20 μs) for NPE (+1) module
- Maximum continuous operational voltage U_c 280 V AC per module and 255 V AC for NPE (+1) module
- Due to I_{imp} 25 kA per module suitable for LPL I - IV according to EN 62305 in standard 3-phase TN-C and TN-S installations



Operating voltage	Connection	Signaling contact	Article No.	Type	Packing
280 V AC	3+0	no	105503	Ex9UE1+2 25 3P 280	1/27
280 V AC	3+0	yes	105504	Ex9UE1+2 25R 3P 280	1/27
280 V AC	3+1	no	105505	Ex9UE1+2 25 3PN 280	1/18
280 V AC	3+1	yes	105506	Ex9UE1+2 25R 3PN 280	1/18
280 V AC	4+0	no	105507	Ex9UE1+2 25 4P 280	1/18
280 V AC	4+0	yes	105508	Ex9UE1+2 25R 4P 280	1/18

Type 1+2 spare modules, $I_{imp} = 25 \text{ kA (10/350 } \mu\text{s)}$



Max. oper. voltage U_c	Max. imp. current I_{imp}	Article No.	Type	
280 V AC	25 kA	105495	Ex9UE1+2 25 1P 280 M	1/81
255 V AC	100 kA	105496	Ex9UE1+2 100 NPE M	1/81

Surge Protection Devices Ex9UE1+2, 12.5 kA



- Surge Protection Devices
- Type 1+2 (Class I+II, T1+T2, B+C)
- Tested according to EN 61643-11
- Max. impulse current I_{imp} 12.5 kA (10/350 μ s) per module and 50 kA for NPE module
- Maximum continuous operational voltage U_c from 275 V up to 440 V AC
- Versions with 1+0, 1+1, 2+0, 3+0, 3+1 and 4+0 connection
- Plug-in module design
- With and without remote indication contact
- Device status indicator

The Ex9UE1+2 12.5 line is a group of Class I+II Surge Protective Devices. They are intended as a protection against indirect and low intensity direct hits of lightning strokes. In standard three phase TN-C grid, they provides protection to LPL III, IV requirements given in EN 62305 with total lightning current introduced into electrical installation of 37.5 kA and total lightning stroke current 75 or 100 kA based on physical configuration and mutual position of grounding point of lightning rod, grounding point of the electrical installation and place of SPD installation.

The design of Ex9UE1+2 12.5 is based on high energy Metal Oxide Varistors. Such design provides low response time and ensures characteristics for both classes I and II. The modular design with plug in inserts allows simple and quick replacement of function modules in case of MOV is beyond if its lifespan due to high intensity or often occurrence of overvoltage peaks.

Type Key

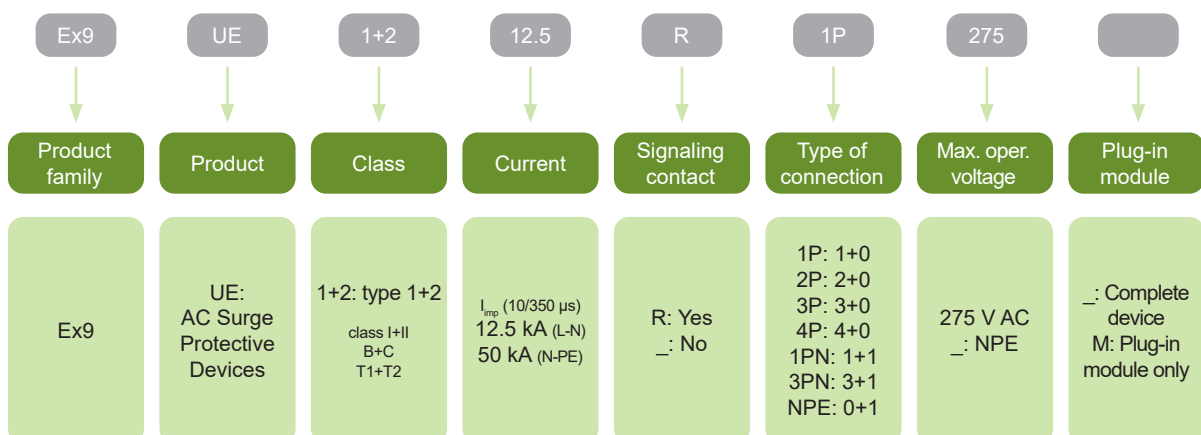

Certification marks



Surge Protection Devices Ex9UE1+2, 12.5 kA

Type 1+2 SPDs (Class I+II, T1+T2, B+C) complete devices, $I_{imp} = 12.5 \text{ kA (10/350 } \mu\text{s)}$

- Maximum impulse current I_{imp} 12.5 kA (10/350 μs) per module and 50 kA (10/350 μs) for NPE (+1) module
- Nominal discharge current I_n 25 kA (8/20 μs) per module and 50 kA (8/20 μs) for NPE (+1) module
- Maximum discharge current I_{max} 50 kA (8/20 μs)
- Maximum continuous operational voltage U_c 275 V AC per module and 255 V AC for NPE (+1) module
- Due to I_{imp} 12.5 kA per module suitable for LPL III and LPL IV according to EN 62305 in standard 3-phase TN-C and TN-S installations



Operating voltage	Connection	Signaling contact	Article No.	Type	Packing
275 V AC	1+0	no	103332	Ex9UE1+2 12.5 1P 275	1/96
275 V AC	1+0	yes	103333	Ex9UE1+2 12.5R 1P 275	1/96
275 V AC	1+1	no	103334	Ex9UE1+2 12.5 1PN 275	1/60
275 V AC	1+1	yes	103335	Ex9UE1+2 12.5R 1PN 275	1/60
275 V AC	2+0	no	103336	Ex9UE1+2 12.5 2P 275	1/60
275 V AC	2+0	yes	103337	Ex9UE1+2 12.5R 2P 275	1/60
275 V AC	3+0	no	103338	Ex9UE1+2 12.5 3P 275	1/54
275 V AC	3+0	yes	103339	Ex9UE1+2 12.5R 3P 275	1/54
275 V AC	3+1	no	103340	Ex9UE1+2 12.5 3PN 275	1/45
275 V AC	3+1	yes	103341	Ex9UE1+2 12.5R 3PN 275	1/45
275 V AC	4+0	no	103342	Ex9UE1+2 12.5 4P 275	1/45
275 V AC	4+0	yes	103343	Ex9UE1+2 12.5R 4P 275	1/45

Type 1+2 spare modules, $I_{imp} = 12.5 \text{ kA (10/350 } \mu\text{s)}$



Max. oper. voltage U_c	Max. imp. current I_{imp}	Article No.	Type
275 V AC	12.5 kA	103330	Ex9UE1+2 12.5 1P 275 M
N-PE	50 kA	103331	Ex9UE1+2 NPE M

Surge Protection Devices Ex9UE2



- Surge Protection Devices
- Type 2 (Class II, T2, C)
- Tested according to EN 61643-11
- Nominal discharge current I_n 20 kA (8/20 μ s) per module and 40 kA for NPE module
- Maximum continuous operational voltage U_c from 275 V up to 440 V AC
- Versions with 1+0, 1+1, 2+0, 3+0, 3+1 and 4+0 connection
- Plug-in module design
- With and without remote indication contact
- Device status indicator

The Ex9UE2 line is a group of Class II Surge Protective Devices. They are intended as a protection against transient overvoltage caused by fast switching operations or indirect hits of lightning strokes (residuum effects).

It is recommended to install Class II SPDs every 10 – 20 meters of cable length repetitively, typically to main and sub distribution boards. The Ex9UE2 20 440 are designed for direct coordination with Class I SPDs of line Ex9UE1 35. In case of Ex9UE2 20 275, the coordination with the line Ex9UE1 35 is done by means of 10 m cable length.

The design of Ex9UE2 is based on Metal Oxide Varistors. Such design provides very low response time. The modular design with plug in inserts allows simple and quick replacement of function modules in case of MOV is beyond if its lifespan due to often occurrence of overvoltage peaks.

Type Key

Ex9	UE	1+2	12.5	R	1P	275	
Product family	Product	Class	Current	Signaling contact	Type of connection	Max. oper. voltage	Plug-in module
Ex9	UE: AC Surge Protective Devices	2: type 2 class II C T2	I_n (8/20 μ s) 20 kA (L-N) 40 kA (N-PE)	R: Yes _: No	1P: 1+0 2P: 2+0 3P: 3+0 4P: 4+0 1PN: 1+1 3PN: 3+1 NPE: 0+1	275 V AC 320 V AC 385 V AC 440 V AC _: NPE	_ : Complete device M: Plug-in module only

Certification marks



Surge Protection Devices Ex9UE2

Type 2 SPD (Class II, T2, C) complete devices, $I_n = 20 \text{ kA (8/20 } \mu\text{s)}$

- Nominal discharge current I_n 20 kA (8/20 μs) per module and 40 kA (8/20 μs) for NPE (+1) module
- Maximum discharge current I_{max} 40 kA (8/20 μs)



Max. oper. voltage U_c	Connection	Signaling contact	Article No.	Type	Packing
275 V AC	1+0	no	103347	Ex9UE2 20 1P 275	1/96
275 V AC	1+0	yes	103348	Ex9UE2 20R 1P 275	1/96
275 V AC	1+1	no	103349	Ex9UE2 20 1PN 275	1/60
275 V AC	1+1	yes	103350	Ex9UE2 20R 1PN 275	1/60
275 V AC	2+0	no	103351	Ex9UE2 20 2P 275	1/60
275 V AC	2+0	yes	103352	Ex9UE2 20R 2P 275	1/60
275 V AC	3+0	no	103353	Ex9UE2 20 3P 275	1/54
275 V AC	3+0	yes	103354	Ex9UE2 20R 3P 275	1/54
275 V AC	3+1	no	103355	Ex9UE2 20 3PN 275	1/45
275 V AC	3+1	yes	103356	Ex9UE2 20R 3PN 275	1/45
275 V AC	4+0	no	103357	Ex9UE2 20 4P 275	1/45
275 V AC	4+0	yes	103358	Ex9UE2 20R 4P 275	1/45
320 V AC	1+0	no	103754	Ex9UE2 20 1P 320	1/96
320 V AC	1+0	yes	103755	Ex9UE2 20R 1P 320	1/96
320 V AC	1+1	no	103756	Ex9UE2 20 1PN 320	1/60
320 V AC	1+1	yes	103757	Ex9UE2 20R 1PN 320	1/60
320 V AC	2+0	no	103758	Ex9UE2 20 2P 320	1/60
320 V AC	2+0	yes	103759	Ex9UE2 20R 2P 320	1/60
320 V AC	3+0	no	103760	Ex9UE2 20 3P 320	1/54
320 V AC	3+0	yes	103761	Ex9UE2 20R 3P 320	1/54
320 V AC	3+1	no	103762	Ex9UE2 20 3PN 320	1/45
320 V AC	3+1	yes	103763	Ex9UE2 20R 3PN 320	1/45
320 V AC	4+0	no	103764	Ex9UE2 20 4P 320	1/45
320 V AC	4+0	yes	103765	Ex9UE2 20R 4P 320	1/45
385 V AC	1+0	no	103766	Ex9UE2 20 1P 385	1/96
385 V AC	1+0	yes	103767	Ex9UE2 20R 1P 385	1/96
385 V AC	1+1	no	103768	Ex9UE2 20 1PN 385	1/60
385 V AC	1+1	yes	103769	Ex9UE2 20R 1PN 385	1/60
385 V AC	2+0	no	103770	Ex9UE2 20 2P 385	1/60
385 V AC	2+0	yes	103771	Ex9UE2 20R 2P 385	1/60
385 V AC	3+0	no	103772	Ex9UE2 20 3P 385	1/54
385 V AC	3+0	yes	103773	Ex9UE2 20R 3P 385	1/54
385 V AC	3+1	no	103774	Ex9UE2 20 3PN 385	1/45
385 V AC	3+1	yes	103775	Ex9UE2 20R 3PN 385	1/45
385 V AC	4+0	no	103776	Ex9UE2 20 4P 385	1/45
385 V AC	4+0	yes	103777	Ex9UE2 20R 4P 385	1/45
440 V AC	1+0	no	103359	Ex9UE2 20 1P 440	1/96
440 V AC	1+0	yes	103360	Ex9UE2 20R 1P 440	1/96
440 V AC	1+1	no	103361	Ex9UE2 20 1PN 440	1/60
440 V AC	1+1	yes	103362	Ex9UE2 20R 1PN 440	1/60
440 V AC	2+0	no	103363	Ex9UE2 20 2P 440	1/60
440 V AC	2+0	yes	103364	Ex9UE2 20R 2P 440	1/60
440 V AC	3+0	no	103365	Ex9UE2 20 3P 440	1/54
440 V AC	3+0	yes	103366	Ex9UE2 20R 3P 440	1/54
440 V AC	3+1	no	103367	Ex9UE2 20 3PN 440	1/45
440 V AC	3+1	yes	103368	Ex9UE2 20R 3PN 440	1/45
440 V AC	4+0	no	103369	Ex9UE2 20 4P 440	1/45
440 V AC	4+0	yes	103370	Ex9UE2 20R 4P 440	1/45

Type 2 SPD spare modules, $I_n = 20 \text{ kA (8/20 } \mu\text{s)}$



Max. oper. voltage U_c	Nominal current I_n	Article No.	Type
275 V AC	20 kA	103344	Ex9UE2 20 1P 275 M
320 V AC	20 kA	103752	Ex9UE2 20 1P 320 M
385 V AC	20 kA	103753	Ex9UE2 20 1P 385 M
440 V AC	20 kA	103345	Ex9UE2 20 1P 440 M
N-PE	40 kA	103346	Ex9UE2 40 NPE M

Surge Protection Devices Ex9UE3



- Surge Protection Devices
- Type 3 (Class III, T3, D)
- Tested according to EN 61643-11
- Maximum continuous operational voltage U_c 275 V AC
- Design based on Y connection of functional elements
- Plug-in module design
- With and without remote indication contact
- Device status indicator on the front side

The Ex9UE3 line is a group of Class III Surge Protective Devices. They are intended as a fine protection against transient overvoltage, installed downstream to Class II SPDs. The application field of Ex9UE3 is protection of sensitive electronics used in or close to distribution board, typically home automation, IT systems etc. The Y connection of functional elements provides balanced protection of L and N conductor towards PE thanks to identical MOVs for both working conductors and full isolation due to connection to PE via Spark Gap.

Class III SPDs should be installed maximum 5 meters from the protected device. Coordination with Class II SPDs Ex9UE2 20 is defined also for near installation. To reach best parameters, it is recommended to install both classes with mutual distance of 5 meters of connecting cables.

The design of Ex9UE3 is based on Metal Oxide Varistors. Such design provides very low response time. The modular design with plug in inserts allows simple and quick replacement of function modules in case of MOV is beyond if its lifespan due to often occurrence of overvoltage peaks.

Type Key

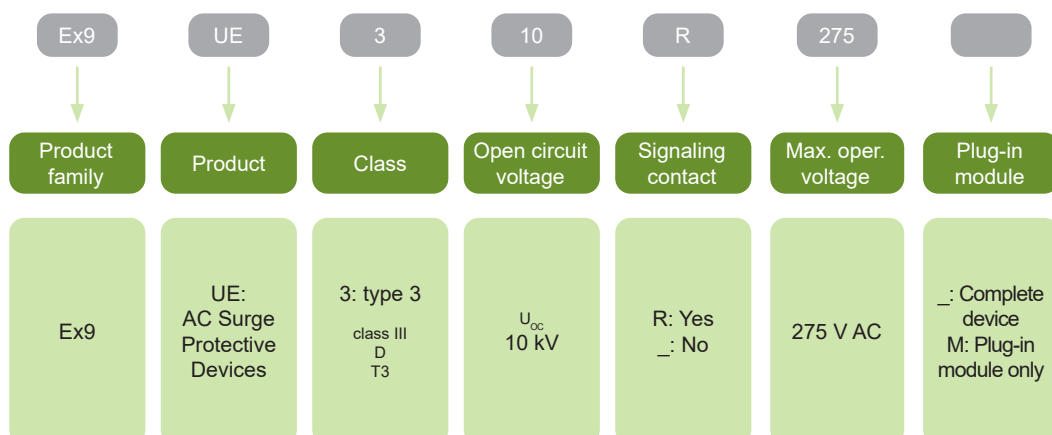

Certification marks



Surge Protection Devices Ex9UE3

Type 3 SPDs (Class III, T3, D) - complete devices, $I_{max} = 10 \text{ kA (8/20 } \mu\text{s)}$

- Maximum discharge current I_{max} 10 kA (8/20 μs)
- Nominal discharge current I_n 5 kA (8/20 μs)
- Maximum continuous operational voltage U_c 275 V AC
- Open circuit voltage U_{oc} 10 kV



Max. oper. voltage U_c	Connection	Signaling contact	Article No.	Type	Packing
275 V AC	1+1	no	106858	Ex9UE3 10 275	1/60
275 V AC	1+1	yes	106857	Ex9UE3 10R 275	1/60

Type 3 SPDs (Class III, T3, D) - spare modules



Max. oper. voltage U_c	Max. discharge current I_{max}	Article No.	Type	Packing
275 V AC	10 kA	106859	Ex9UE3 10 275 M	1

Installation relays and contactors



Installation relays and contactors

Professional Tips

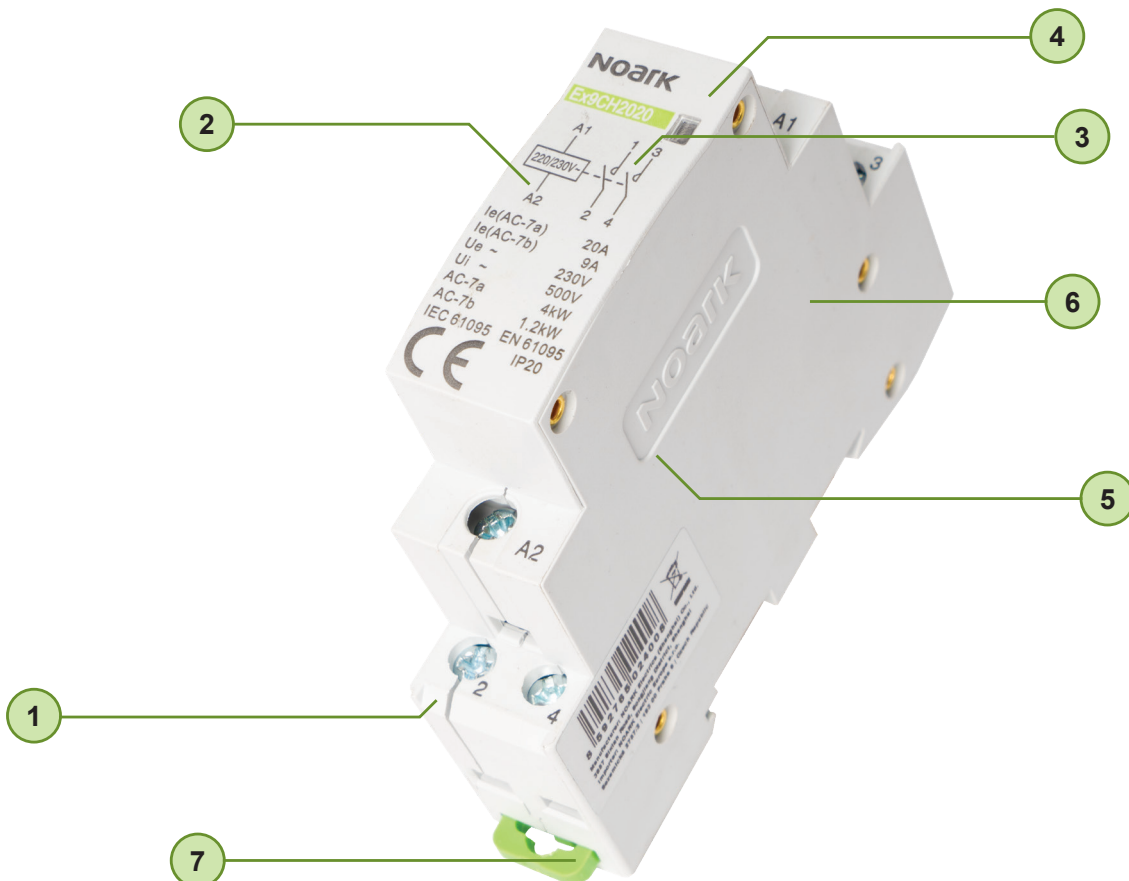

1 5 year warranty

2 Connection diagram on the device

3 Contact state indicator

4 Various contact combinations

5 Various coil voltages

6 1-pole to 4-pole version

7 Easy mounting on DIN rail

Installation relays Ex9CH20



- Installation relays
- Meet requirements of IEC / EN 61095
- Rated current up to 20 A
- Control coil voltage 24, 230 or 240 V AC
- Rated frequency 50/60 Hz
- 1, 2 or 4-contact versions
- Various contact combinations

Modular relays Ex9CH20 are suitable for household and building modular distribution boards. They are mainly used in building automation processes for switching and controlling lightings, heating systems, ventilations, pumps, heating pumps and other applications.

Optical indicator on the front side indicates status of the contacts and voltage on control coil.

Type Key

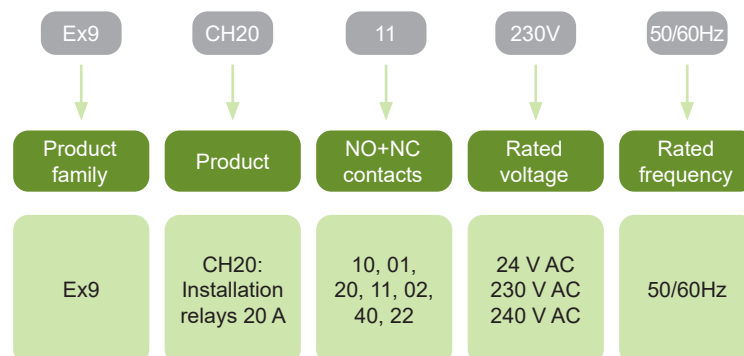

Certification marks



Installation relays Ex9CH20

Installation relays 20 A, width 1 MU



Control voltage	Contacts NO+NC	Article No.	Type	Packing
230 V AC	10	107011	Ex9CH20 10 230V 50/60Hz	2/162
230 V AC	01	107014	Ex9CH20 01 230V 50/60Hz	2/162
240 V AC	10	107012	Ex9CH20 10 240V 50/60Hz	2/162
240 V AC	01	107015	Ex9CH20 01 240V 50/60Hz	2/162
24 V AC	10	107010	Ex9CH20 10 24V 50/60Hz	2/162
24 V AC	01	107013	Ex9CH20 01 24V 50/60Hz	2/162
230 V AC	20	102399	Ex9CH20 20 230V 50/60Hz	2/162
230 V AC	11	102402	Ex9CH20 11 230V 50/60Hz	2/162
230 V AC	02	102405	Ex9CH20 02 230V 50/60Hz	2/162
240 V AC	20	102400	Ex9CH20 20 240V 50/60Hz	2/162
240 V AC	11	102403	Ex9CH20 11 240V 50/60Hz	2/162
240 V AC	02	102406	Ex9CH20 02 240V 50/60Hz	2/162
24 V AC	20	102398	Ex9CH20 20 24V 50/60Hz	2/162
24 V AC	11	102401	Ex9CH20 11 24V 50/60Hz	2/162
24 V AC	02	102404	Ex9CH20 02 24V 50/60Hz	2/162

Installation relays 20 A, width 2 MU



Control voltage	Contacts NO+NC	Article No.	Type	Packing
230 V AC	40	102408	Ex9CH20 40 230V 50/60Hz	1/81
230 V AC	22	102410	Ex9CH20 22 230V 50/60Hz	1/81
230 V AC	31	107318	Ex9CH20 31 230V 50/60Hz	1/81
24 V AC	40	102407	Ex9CH20 40 24V 50/60Hz	1/81
24 V AC	22	102409	Ex9CH20 22 24V 50/60Hz	1/81
24 V AC	31	107317	Ex9CH20 31 24V 50/60Hz	1/81

Distance block between Ex9CH devices, width 0.5 MU



Description	Article No.	Type
Distance block/separator	107956	Ex9CH20 SP

Installation contactors Ex9CH



- Installation contactors Ex9CH
- Meet requirements of IEC / EN 61095
- Rated current up to 25, 40, 63 A
- Control coil voltage 24, 230 or 240 V AC
- Rated frequency 50/60 Hz
- 2 or 4-contact versions
- Various contact combinations

Modular contactors Ex9CH are suitable for household and building modular distribution boards. They are mainly used in building automation processes for switching and controlling lightings, heating systems, ventilations, pumps, heating pumps and other applications.

Optical indicator on the front side indicates status of the contacts and voltage on control coil.

Type Key

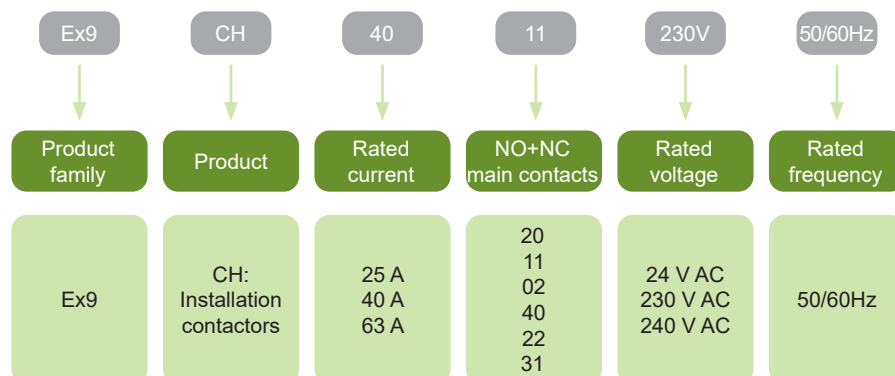

Certification marks



Installation contactors Ex9CH

Installation contactors 25 A, width 1MU



Control voltage	Contacts NO+NC	Article No.	Type	Packing
230 V AC	02	107017	Ex9CH25 02 230V 50/60Hz	2/162
240 V AC	02	107018	Ex9CH25 02 240V 50/60Hz	2/162
24 V AC	02	107016	Ex9CH25 02 24V 50/60Hz	2/162

Installation contactors 25 A, width 2MU



Control voltage	Contacts NO+NC	Article No.	Type	Packing
230 V AC	40	102412	Ex9CH25 40 230V 50/60Hz	1/81
230 V AC	31	107020	Ex9CH25 31 230V 50/60Hz	1/81
230 V AC	22	102414	Ex9CH25 22 230V 50/60Hz	1/81
24 V AC	40	102411	Ex9CH25 40 24V 50/60Hz	1/81
24 V AC	31	107019	Ex9CH25 31 24V 50/60Hz	1/81
24 V AC	22	102413	Ex9CH25 22 24V 50/60Hz	1/81

Installation contactors Ex9CH

Installation contactors 40 A, width 2MU



Control voltage	Contacts NO+NC	Article No.	Type	Packing
230 V AC	20	102416	Ex9CH40 20 230V 50/60Hz	1/81
230 V AC	02	107024	Ex9CH40 02 230V 50/60Hz	1/81
230 V AC	11	102418	Ex9CH40 11 230V 50/60Hz	1/81
24 V AC	20	102415	Ex9CH40 20 24V 50/60Hz	1/81
24 V AC	02	107023	Ex9CH40 02 24V 50/60Hz	1/81
24 V AC	11	102417	Ex9CH40 11 24V 50/60Hz	1/81

Installation contactors 40 A, width 3MU



Control voltage	Contacts NO+NC	Article No.	Type	Packing
230 V AC	40	102420	Ex9CH40 40 230V 50/60Hz	1/54
230 V AC	31	107022	Ex9CH40 31 230V 50/60Hz	1/54
240 V AC	40	102421	Ex9CH40 40 240V 50/60Hz	1/54
24 V AC	40	102419	Ex9CH40 40 24V 50/60Hz	1/54
24 V AC	31	107021	Ex9CH40 31 24V 50/60Hz	1/54

Installation contactors Ex9CH

Installation contactors 63 A, width 2MU



Control voltage	Contacts NO+NC	Article No.	Type	Packing
230 V AC	20	102423	Ex9CH63 20 230V 50/60Hz	1/81
230 V AC	02	107026	Ex9CH63 02 230V 50/60Hz	1/81
230 V AC	11	102425	Ex9CH63 11 230V 50/60Hz	1/81
24 V AC	20	102422	Ex9CH63 20 24V 50/60Hz	1/81
24 V AC	02	107025	Ex9CH63 02 24V 50/60Hz	1/81
24 V AC	11	102424	Ex9CH63 11 24V 50/60Hz	1/81

Installation contactors 63 A, width 3MU



Control voltage	Contacts NO+NC	Article No.	Type	Packing
230 V AC	40	102427	Ex9CH63 40 230V 50/60Hz	1/54
230 V AC	31	107028	Ex9CH63 31 230V 50/60Hz	1/54
240 V AC	40	102428	Ex9CH63 40 240V 50/60Hz	1/54
24 V AC	40	102426	Ex9CH63 40 24V 50/60Hz	1/54
24 V AC	31	107027	Ex9CH63 31 24V 50/60Hz	1/54

Distance block between Ex9CH devices, width 0.5MU



Description	Article No.	Type
Distance block/separator	107956	Ex9CH20 SP

Installation contactor with manual operation Ex9CHM



- Meet requirements of IEC/EN 61095
- Rated current up to 16, 20, 25, 32, 40, 63 A
- Rated voltage 24, 110, 220-240 V AC
- Rated frequency 50/60 Hz
- 2 or 4-contact versions
- Various contact combinations
- 4 selectable position (O , AUTO , I , I+P)

Installation contactors with manual operation Ex9CHM are suitable for household and building modular distribution boards. It is used as remote or manual switch for circuit control under AC-7b and AC-7a application category (e.g. mixers, blenders, fans, central vacuum).

The contactor shall not be used for breaking short-circuit current, therefore it should be used with a proper short-circuit protection device.

The contactor has 4 selectable positions:

- O - permanently OFF
- AUTO - switched while the supply voltage is provided to the coil
- I - manually switched , automatically returns to "AUTO" position after the supply voltage ends
- I+P - permanently ON

Type Key

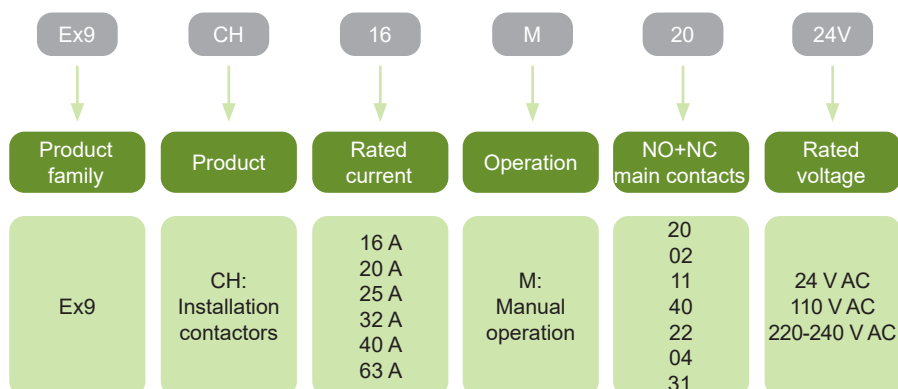

Certification marks



Installation contactor with manual operation Ex9CHM

Installation contactors with manual operation 16 A, 2 contacts



Control voltage	Contacts NO+NC	Article No.	Type	Packing
24V AC	20	111595	Ex9CH16M 20 24V	1/12/120
24V AC	02	111596	Ex9CH16M 02 24V	1/12/120
24V AC	11	111597	Ex9CH16M 11 24V	1/12/120
110V AC	20	111602	Ex9CH16M 20 110V	1/12/120
110V AC	02	111603	Ex9CH16M 02 110V	1/12/120
110V AC	11	111604	Ex9CH16M 11 110V	1/12/120
220~240V AC	20	111609	Ex9CH16M 20 220-240V	1/12/120
220~240V AC	02	111610	Ex9CH16M 02 220-240V	1/12/120
220~240V AC	11	111611	Ex9CH16M 11 220-240V	1/12/120

Installation contactors with manual operation 16 A, 4 contacts



Control voltage	Contacts NO+NC	Article No.	Type	Packing
24V AC	40	111598	Ex9CH16M 40 24V	1/6/60
24V AC	22	111599	Ex9CH16M 22 24V	1/6/60
24V AC	04	111600	Ex9CH16M 04 24V	1/6/60
24V AC	31	111601	Ex9CH16M 31 24V	1/6/60
110V AC	40	111605	Ex9CH16M 40 110V	1/6/60
110V AC	22	111606	Ex9CH16M 22 110V	1/6/60
110V AC	04	111607	Ex9CH16M 04 110V	1/6/60
110V AC	31	111608	Ex9CH16M 31 110V	1/6/60
220~240V AC	40	111612	Ex9CH16M 40 220-240V	1/6/60
220~240V AC	22	111613	Ex9CH16M 22 220-240V	1/6/60
220~240V AC	04	111614	Ex9CH16M 04 220-240V	1/6/60
220~240V AC	31	111615	Ex9CH16M 31 220-240V	1/6/60

Installation contactor with manual operation Ex9CHM

Installation contactors with manual operation 20 A, 2 contacts



Control voltage	Contacts NO+NC	Article No.	Type	Packing
24V AC	20	111616	Ex9CH20M 20 24V	1/12/120
24V AC	02	111617	Ex9CH20M 02 24V	1/12/120
24V AC	11	111618	Ex9CH20M 11 24V	1/12/120
110V AC	20	111623	Ex9CH20M 20 110V	1/12/120
110V AC	02	111624	Ex9CH20M 02 110V	1/12/120
110V AC	11	111625	Ex9CH20M 11 110V	1/12/120
220~240V AC	20	111630	Ex9CH20M 20 220-240V	1/12/120
220~240V AC	02	111631	Ex9CH20M 02 220-240V	1/12/120
220~240V AC	11	111632	Ex9CH20M 11 220-240V	1/12/120

Installation contactors with manual operation 20 A, 4 contacts



Control voltage	Contacts NO+NC	Article No.	Type	Packing
24V AC	40	111619	Ex9CH20M 40 24V	1/6/60
24V AC	22	111620	Ex9CH20M 22 24V	1/6/60
24V AC	04	111621	Ex9CH20M 04 24V	1/6/60
24V AC	31	111622	Ex9CH20M 31 24V	1/6/60
110V AC	40	111626	Ex9CH20M 40 110V	1/6/60
110V AC	22	111627	Ex9CH20M 22 110V	1/6/60
110V AC	04	111628	Ex9CH20M 04 110V	1/6/60
110V AC	31	111629	Ex9CH20M 31 110V	1/6/60
220~240V AC	40	111633	Ex9CH20M 40 220-240V	1/6/60
220~240V AC	22	111634	Ex9CH20M 22 220-240V	1/6/60
220~240V AC	04	111635	Ex9CH20M 04 220-240V	1/6/60
220~240V AC	31	111636	Ex9CH20M 31 220-240V	1/6/60

Installation contactor with manual operation Ex9CHM

Installation contactors with manual operation 25 A, 2 contacts



Control voltage	Contacts NO+NC	Article No.	Type	Packing
24V AC	20	111637	Ex9CH25M 20 24V	1/12/120
24V AC	02	111638	Ex9CH25M 02 24V	1/12/120
24V AC	11	111639	Ex9CH25M 11 24V	1/12/120
110V AC	20	111644	Ex9CH25M 20 110V	1/12/120
110V AC	02	111645	Ex9CH25M 02 110V	1/12/120
110V AC	11	111646	Ex9CH25M 11 110V	1/12/120
220~240V AC	20	111651	Ex9CH25M 20 220-240V	1/12/120
220~240V AC	02	111652	Ex9CH25M 02 220-240V	1/12/120
220~240V AC	11	111653	Ex9CH25M 11 220-240V	1/12/120

Installation contactors with manual operation 25 A, 4 contacts



Control voltage	Contacts NO+NC	Article No.	Type	Packing
24V AC	40	111640	Ex9CH25M 40 24V	1/6/60
24V AC	22	111641	Ex9CH25M 22 24V	1/6/60
24V AC	04	111642	Ex9CH25M 04 24V	1/6/60
24V AC	31	111643	Ex9CH25M 31 24V	1/6/60
110V AC	40	111647	Ex9CH25M 40 110V	1/6/60
110V AC	22	111648	Ex9CH25M 22 110V	1/6/60
110V AC	04	111649	Ex9CH25M 04 110V	1/6/60
110V AC	31	111650	Ex9CH25M 31 110V	1/6/60
220~240V AC	40	111654	Ex9CH25M 40 220-240V	1/6/60
220~240V AC	22	111655	Ex9CH25M 22 220-240V	1/6/60
220~240V AC	04	111656	Ex9CH25M 04 220-240V	1/6/60
220~240V AC	31	111657	Ex9CH25M 31 220-240V	1/6/60

Installation contactor with manual operation Ex9CHM

Installation contactors with manual operation 32 A, 2 contacts



Control voltage	Contacts NO+NC	Article No.	Type	Packing
24V AC	20	111700	Ex9CH32M 20 24V	1/6/60
24V AC	02	111701	Ex9CH32M 02 24V	1/6/60
24V AC	11	111702	Ex9CH32M 11 24V	1/6/60
110V AC	20	111707	Ex9CH32M 20 110V	1/6/60
110V AC	02	111708	Ex9CH32M 02 110V	1/6/60
110V AC	11	111709	Ex9CH32M 11 110V	1/6/60
220~240V AC	20	111714	Ex9CH32M 20 220-240V	1/6/60
220~240V AC	02	111715	Ex9CH32M 02 220-240V	1/6/60
220~240V AC	11	111716	Ex9CH32M 11 220-240V	1/6/60

Installation contactors with manual operation 32 A, 4 contacts



Control voltage	Contacts NO+NC	Article No.	Type	Packing
24V AC	40	111703	Ex9CH32M 40 24V	1/4/40
24V AC	22	111704	Ex9CH32M 22 24V	1/4/40
24V AC	04	111705	Ex9CH32M 04 24V	1/4/40
24V AC	31	111706	Ex9CH32M 31 24V	1/4/40
110V AC	40	111710	Ex9CH32M 40 110V	1/4/40
110V AC	22	111711	Ex9CH32M 22 110V	1/4/40
110V AC	04	111712	Ex9CH32M 04 110V	1/4/40
110V AC	31	111713	Ex9CH32M 31 110V	1/4/40
220~240V AC	40	111717	Ex9CH32M 40 220-240V	1/4/40
220~240V AC	22	111718	Ex9CH32M 22 220-240V	1/4/40
220~240V AC	04	111719	Ex9CH32M 04 220-240V	1/4/40
220~240V AC	31	111720	Ex9CH32M 31 220-240V	1/4/40

Installation contactor with manual operation Ex9CHM

Installation contactors with manual operation 40 A, 2 contacts



Control voltage	Contacts NO+NC	Article No.	Type	Packing
24V AC	20	111658	Ex9CH40M 20 24V	1/6/60
24V AC	02	111659	Ex9CH40M 02 24V	1/6/60
24V AC	11	111660	Ex9CH40M 11 24V	1/6/60
110V AC	20	111665	Ex9CH40M 20 110V	1/6/60
110V AC	02	111666	Ex9CH40M 02 110V	1/6/60
110V AC	11	111667	Ex9CH40M 11 110V	1/6/60
220~240V AC	20	111672	Ex9CH40M 20 220-240V	1/6/60
220~240V AC	02	111673	Ex9CH40M 02 220-240V	1/6/60
220~240V AC	11	111674	Ex9CH40M 11 220-240V	1/6/60

Installation contactors with manual operation 40 A, 4 contacts



Control voltage	Contacts NO+NC	Article No.	Type	Packing
24V AC	40	111661	Ex9CH40M 40 24V	1/4/40
24V AC	22	111662	Ex9CH40M 22 24V	1/4/40
24V AC	04	111663	Ex9CH40M 04 24V	1/4/40
24V AC	31	111664	Ex9CH40M 31 24V	1/4/40
110V AC	40	111668	Ex9CH40M 22 110V	1/4/40
110V AC	22	111669	Ex9CH40M 22 110V	1/4/40
110V AC	04	111670	Ex9CH40M 04 110V	1/4/40
110V AC	31	111671	Ex9CH40M 31 110V	1/4/40
220~240V AC	40	111675	Ex9CH40M 40 220-240V	1/4/40
220~240V AC	22	111676	Ex9CH40M 22 220-240V	1/4/40
220~240V AC	04	111677	Ex9CH40M 04 220-240V	1/4/40
220~240V AC	31	111678	Ex9CH40M 31 220-240V	1/4/40

Installation contactor with manual operation Ex9CHM

Installation contactors with manual operation 63 A, 2 contacts



Control voltage	Contacts NO+NC	Article No.	Type	Packing
24V AC	20	111679	Ex9CH63M 20 24V	1/6/60
24V AC	02	111680	Ex9CH63M 02 24V	1/6/60
24V AC	11	111681	Ex9CH63M 11 24V	1/6/60
110V AC	20	111686	Ex9CH63M 20 110V	1/6/60
110V AC	02	111687	Ex9CH63M 02 110V	1/6/60
110V AC	11	111688	Ex9CH63M 11 110V	1/6/60
220~240V AC	20	111693	Ex9CH63M 20 220-240V	1/6/60
220~240V AC	02	111694	Ex9CH63M 02 220-240V	1/6/60
220~240V AC	11	111695	Ex9CH63M 11 220-240V	1/6/60

Installation contactors with manual operation 63 A, 4 contacts



Control voltage	Contacts NO+NC	Article No.	Type	Packing
24V AC	40	111682	Ex9CH63M 40 24V	1/4/40
24V AC	22	111683	Ex9CH63M 22 24V	1/4/40
24V AC	04	111684	Ex9CH63M 04 24V	1/4/40
24V AC	31	111685	Ex9CH63M 31 24V	1/4/40
110V AC	40	111689	Ex9CH63M 40 110V	1/4/40
110V AC	22	111690	Ex9CH63M 22 110V	1/4/40
110V AC	04	111691	Ex9CH63M 04 110V	1/4/40
110V AC	31	111692	Ex9CH63M 31 110V	1/4/40
220~240V AC	40	111696	Ex9CH63M 40 220-240V	1/4/40
220~240V AC	22	111697	Ex9CH63M 22 220-240V	1/4/40
220~240V AC	04	111698	Ex9CH63M 04 220-240V	1/4/40
220~240V AC	31	111699	Ex9CH63M 31 220-240V	1/4/40

Impulse relays Ex9JU



- Meet requirements of IEC / EN 61810
- Rated current 16 or 32 A
- Control coil voltage 24, 220 or 230 V AC and 24 or 127 V DC
- Rated frequency 50 Hz
- 1, 2, 3 or 4-contact versions

Impulse relays Ex9JU are suitable mainly for household where is low power consumption required. Change-over contacts are switched while impulse is provided to the coil. They are mainly used in building automation processes for switching and controlling lightings, heating systems, ventilations, pumps, heating pumps and other applications.

Impulse relays are offered in two variants of rated current 16 or 32 A. Each version has possibility of up to 4 change-over contacts. Hardware switches on a front of device for manual control.

Type Key

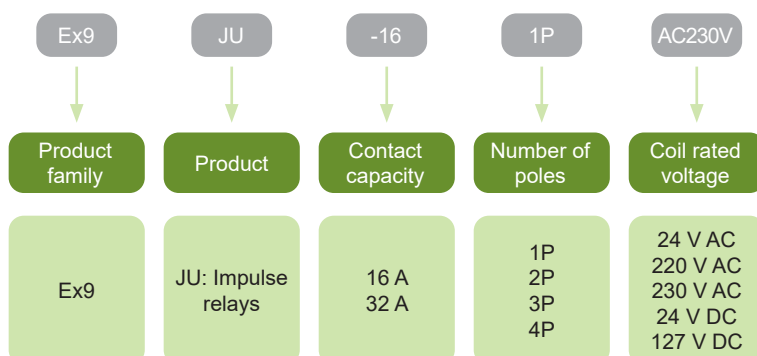

Certification marks



Impulse relays Ex9JU

Impulse relays 16 A

- Rated current 16 A
- 1 to 4 contacts
- Control voltage 24, 220 or 230 V AC and 24 or 127 V DC



Control voltage	Number of contacts	Article No.	Type	Packing
220 V AC	1	110260	Ex9JU-16/1P AC220V	1/12/180
230 V AC	1	110261	Ex9JU-16/1P AC230V	1/12/180
24 V AC	2	110262	Ex9JU-16/2P AC24V	1/12/180
220 V AC	2	110263	Ex9JU-16/2P AC220V	1/12/180
230 V AC	2	110264	Ex9JU-16/2P AC230V	1/12/180
24 V AC	3	110265	Ex9JU-16/3P AC24V	1/6/90
220 V AC	3	110266	Ex9JU-16/3P AC220V	1/6/90
230 V AC	3	110267	Ex9JU-16/3P AC230V	1/6/90
24 V AC	4	110268	Ex9JU-16/4P AC24V	1/6/90
220 V AC	4	110269	Ex9JU-16/4P AC220V	1/6/90
230 V AC	4	110270	Ex9JU-16/4P AC230V	1/6/90
24 V DC	1	110282	Ex9JU-16/1P DC24V	1/12/180
127 V DC	1	110283	Ex9JU-16/1P DC127V	1/12/180
24 V DC	2	110284	Ex9JU-16/2P DC24V	1/12/180
24 V DC	3	110285	Ex9JU-16/3P DC24V	1/6/90
24 V DC	4	110286	Ex9JU-16/4P DC24V	1/6/90

Impulse relays 32 A

- Rated current 32 A
- 1 to 4 contacts
- Control voltage 24, 220 or 230 V AC and 24 V DC



Control voltage	Number of contacts	Article No.	Type	Packing
220 V AC	1	110271	Ex9JU-32/1P AC220V	1/12/180
230 V AC	1	110272	Ex9JU-32/1P AC230V	1/12/180
24 V AC	2	110273	Ex9JU-32/2P AC24V	1/6/90
220 V AC	2	110274	Ex9JU-32/2P AC220V	1/6/90
230 V AC	2	110275	Ex9JU-32/2P AC230V	1/6/90
24 V AC	3	110276	Ex9JU-32/3P AC24V	1/4/60
220 V AC	3	110277	Ex9JU-32/3P AC220V	1/4/60
230 V AC	3	110278	Ex9JU-32/3P AC230V	1/4/60
24 V AC	4	110279	Ex9JU-32/4P AC24V	1/3/45
220 V AC	4	110280	Ex9JU-32/4P AC220V	1/3/45
230 V AC	4	110281	Ex9JU-32/4P AC230V	1/3/45
24 V DC	1	110287	Ex9JU-32/1P DC24V	1/12/180
24 V DC	2	110288	Ex9JU-32/2P DC24V	1/6/90
24 V DC	3	110289	Ex9JU-32/3P DC24V	1/4/60
24 V DC	4	110290	Ex9JU-32/4P DC24V	1/3/45

Notes

A large grid of dashed lines for taking notes, covering most of the page area below the header.

Switch and signal lamps

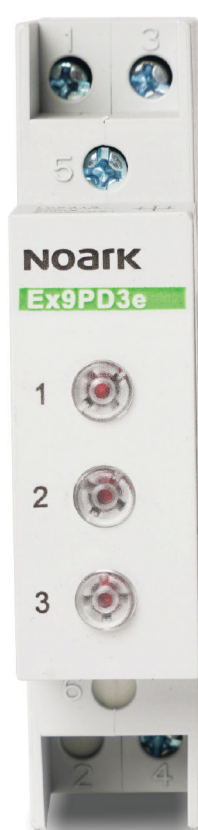

Switches and signal lamps

Professional Tips



- 1 5 year warranty
- 2 1 up to 4-pole versions
- 3 Various contact combinations
- 4 AC/DC LED lamps
- 5 LED lights used
- 6 Various colours and colour combinations
- 7 2-way or 3-way switches
- 8 Easy mounting on DIN rail

Change-Over Switches Ex9BT



- Modular Change-Over Switches
- Meet requirements of EN 60669-1
- Rated current 16 and 32 A
- Rated operating voltage 230/400 V AC
- Versions with and without independent LED signal lamp
- LED rated voltage 48 or 230 V AC/DC
- 1 up to 4-pole versions
- Various contact combinations

Installation switches and change-over switches Ex9BT are designed and intended for switching of auxiliary, control, measuring and other circuits.

They are available in variants with NO, NC and CO contacts. Basic versions with only NO contacts are equipped with toggle in green colour. Types with only NC contacts are delivered with red toggles. All other variants are designed with neutral black toggle.

Besides versions with switch function only and three position (I-0-II) switches, there are available also variants where switches and signal lamp are combined in one device. The signal lamps have separate circuit independent on the contact ones. The colour of used LED is white.

Type Key

Ex9	BT	2	10	16A	LED	230V	AC/DC
↓	↓	↓	↓	↓	↓	↓	↓
Product family	Product	Contact ways	Contacts	Rated current	LED included	LED voltage	LED current char.
Ex9	BT: Change-over switches	2: I-0 3: I-0-II	10, 20, 30, 40 01, 02, 03, 04 11, 22, 13, 31 1CO, 2CO	16A 32A	_ : no LED: yes	230V 48V	AC/DC

Certification marks



Change-Over Switches Ex9BT

2-way change-over switches without LED signal lamp



Rated current	Contacts	Toggle color	Article No.	Type	Packing
16 A	1 NO	green	102656	Ex9BT2 10 16A	1/12/144
16 A	2 NO	green	102657	Ex9BT2 20 16A	1/12/144
16 A	3 NO	green	102658	Ex9BT2 30 16A	1/12/144
16 A	4 NO	green	102659	Ex9BT2 40 16A	1/12/144
16 A	1 NC	red	102660	Ex9BT2 01 16A	1/12/144
16 A	2 NC	red	102661	Ex9BT2 02 16A	1/12/144
16 A	3 NC	red	102662	Ex9BT2 03 16A	1/12/144
16 A	4 NC	red	102663	Ex9BT2 04 16A	1/12/144
16 A	1 NO+1 NC	black	102664	Ex9BT2 11 16A	1/12/144
16 A	2 NO+2 NC	black	102665	Ex9BT2 22 16A	1/12/144
16 A	1 NO+3 NC	black	102666	Ex9BT2 13 16A	1/12/144
16 A	3 NO+1 NC	black	102667	Ex9BT2 31 16A	1/12/144
16 A	1 CO	black	102668	Ex9BT2 1CO 16A	1/12/144
16 A	2 CO	black	102669	Ex9BT2 2CO 16A	1/12/144
32 A	2 NO	green	102670	Ex9BT2 20 32A	1/12/144
32 A	4 NO	green	102671	Ex9BT2 40 32A	1/12/144
32 A	2 NC	red	102672	Ex9BT2 02 32A	1/12/144
32 A	4 NC	red	102673	Ex9BT2 04 32A	1/12/144

2-way change-over switches with LED signal lamp, rated current 16 A

- White LED colour



Contacts	LED voltage	Toggle color	Article No.	Type	Packing
2 NO	230 V AC/DC	green	102674	Ex9BT2 20 16A LED230VAC/DC	1/12/144
2 NO	48 V AC/DC	green	102675	Ex9BT2 20 16A LED48VAC/DC	1/12/144
2 NC	230 V AC/DC	red	102676	Ex9BT2 02 16A LED230VAC/DC	1/12/144
2 NC	48 V AC/DC	red	102677	Ex9BT2 02 16A LED48VAC/DC	1/12/144
1 CO	230 V AC/DC	black	102678	Ex9BT2 1CO 16A LED230VAC/DC	1/12/144
1 CO	48 V AC/DC	black	102679	Ex9BT2 1CO 16A LED48VAC/DC	1/12/144

3-way (I-0-II) change-over switches without LED signal lamp



Rated current	Contacts	Toggle color	Article No.	Type	Packing
16 A	1 CO (I-0-II)	black	102680	Ex9BT3 1CO 16A	1/12/144
16 A	2 CO (I-0-II)	black	102682	Ex9BT3 2CO 16A	1/12/144
32 A	1 CO (I-0-II)	black	102681	Ex9BT3 1CO 32A	1/12/144
32 A	2 CO (I-0-II)	black	102683	Ex9BT3 2CO 32A	1/12/144

Signal lamps Ex9PD



- Installation Signal Lamps
- Meet requirements of IEC / EN 60947-5-1
- LED technology
- Rated operating voltage 6.3 to 230 V AC/DC
- Width 1 MU
- 1 and 2-LED versions
- Various colours and colour combinations

Installation signal lamps Ex9PD are designed and tested according to standard IEC/EN 60947-5-1. They are based on LED technology and suitable e.g. for circuit status indication.

There are available versions with rated operating voltage from 6.3 up to 230 V AC/DC, with 1 and 2 LEDs in various colours and also all combinations of LED colours in double lamp devices to cover all possible applications.

Type Key

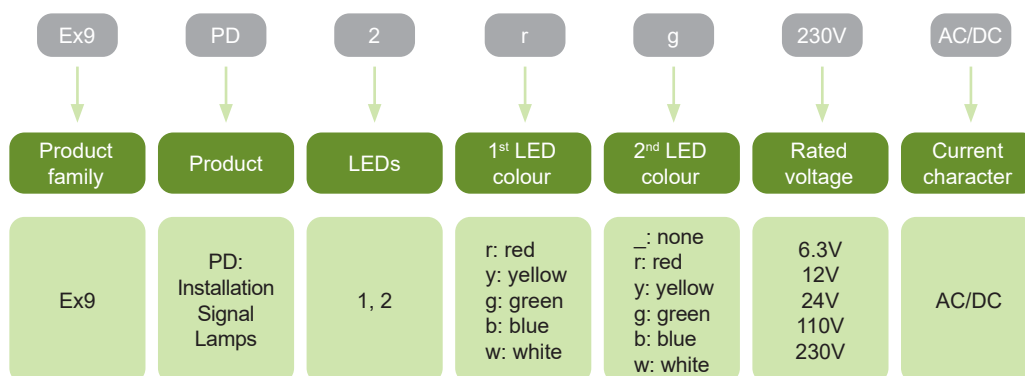

Certification marks



Signal lamps Ex9PD

1-LED version



No of LEDs	Colour	Article No.	Type	Packing
1	red	102429	Ex9PD1r 6.3V AC/DC	2/162
1	red	102430	Ex9PD1r 12V AC/DC	2/162
1	red	102431	Ex9PD1r 24V AC/DC	2/162
1	red	102432	Ex9PD1r 110V AC/DC	2/162
1	red	102433	Ex9PD1r 230V AC/DC	2/162
1	yellow	102434	Ex9PD1y 6.3V AC/DC	2/162
1	yellow	102435	Ex9PD1y 12V AC/DC	2/162
1	yellow	102436	Ex9PD1y 24V AC/DC	2/162
1	yellow	102437	Ex9PD1y 110V AC/DC	2/162
1	yellow	102438	Ex9PD1y 230V AC/DC	2/162
1	green	102439	Ex9PD1g 6.3V AC/DC	2/162
1	green	102440	Ex9PD1g 12V AC/DC	2/162
1	green	102441	Ex9PD1g 24V AC/DC	2/162
1	green	102442	Ex9PD1g 110V AC/DC	2/162
1	green	102443	Ex9PD1g 230V AC/DC	2/162
1	blue	102444	Ex9PD1b 6.3V AC/DC	2/162
1	blue	102445	Ex9PD1b 12V AC/DC	2/162
1	blue	102446	Ex9PD1b 24V AC/DC	2/162
1	blue	102447	Ex9PD1b 110V AC/DC	2/162
1	blue	102448	Ex9PD1b 230V AC/DC	2/162
1	white	102449	Ex9PD1w 6.3V AC/DC	2/162
1	white	102450	Ex9PD1w 12V AC/DC	2/162
1	white	102451	Ex9PD1w 24V AC/DC	2/162
1	white	102452	Ex9PD1w 110V AC/DC	2/162
1	white	102453	Ex9PD1w 230V AC/DC	2/162

Signal lamps Ex9PD

2-LED version



No of LEDs	Colour	Article No.	Type	Packing
2	green, green	102454	Ex9PD2gg 6.3V AC/DC	2/162
2	green, green	102455	Ex9PD2gg 12V AC/DC	2/162
2	green, green	102456	Ex9PD2gg 24V AC/DC	2/162
2	green, green	102457	Ex9PD2gg 110V AC/DC	2/162
2	green, green	102458	Ex9PD2gg 230V AC/DC	2/162
2	green, red	102459	Ex9PD2gr 6.3V AC/DC	2/162
2	green, red	102460	Ex9PD2gr 12V AC/DC	2/162
2	green, red	102461	Ex9PD2gr 24V AC/DC	2/162
2	green, red	102462	Ex9PD2gr 110V AC/DC	2/162
2	green, red	102463	Ex9PD2gr 230V AC/DC	2/162
2	green, yellow	102464	Ex9PD2gy 6.3V AC/DC	2/162
2	green, yellow	102465	Ex9PD2gy 12V AC/DC	2/162
2	green, yellow	102466	Ex9PD2gy 24V AC/DC	2/162
2	green, yellow	102467	Ex9PD2gy 110V AC/DC	2/162
2	green, yellow	102468	Ex9PD2gy 230V AC/DC	2/162
2	green, blue	102469	Ex9PD2gb 6.3V AC/DC	2/162
2	green, blue	102470	Ex9PD2gb 12V AC/DC	2/162
2	green, blue	102471	Ex9PD2gb 24V AC/DC	2/162
2	green, blue	102472	Ex9PD2gb 110V AC/DC	2/162
2	green, blue	102473	Ex9PD2gb 230V AC/DC	2/162
2	green, white	102474	Ex9PD2gw 6.3V AC/DC	2/162
2	green, white	102475	Ex9PD2gw 12V AC/DC	2/162
2	green, white	102476	Ex9PD2gw 24V AC/DC	2/162
2	green, white	102477	Ex9PD2gw 110V AC/DC	2/162
2	green, white	102478	Ex9PD2gw 230V AC/DC	2/162
2	red, red	102479	Ex9PD2rr 6.3V AC/DC	2/162
2	red, red	102480	Ex9PD2rr 12V AC/DC	2/162
2	red, red	102481	Ex9PD2rr 24V AC/DC	2/162
2	red, red	102482	Ex9PD2rr 110V AC/DC	2/162
2	red, red	102483	Ex9PD2rr 230V AC/DC	2/162
2	red, yellow	102484	Ex9PD2ry 6.3V AC/DC	2/162
2	red, yellow	102485	Ex9PD2ry 12V AC/DC	2/162
2	red, yellow	102486	Ex9PD2ry 24V AC/DC	2/162
2	red, yellow	102487	Ex9PD2ry 110V AC/DC	2/162
2	red, yellow	102488	Ex9PD2ry 230V AC/DC	2/162
2	red, blue	102489	Ex9PD2rb 6.3V AC/DC	2/162
2	red, blue	102490	Ex9PD2rb 12V AC/DC	2/162
2	red, blue	102491	Ex9PD2rb 24V AC/DC	2/162
2	red, blue	102492	Ex9PD2rb 110V AC/DC	2/162
2	red, blue	102493	Ex9PD2rb 230V AC/DC	2/162
2	red, white	102494	Ex9PD2rw 6.3V AC/DC	2/162
2	red, white	102495	Ex9PD2rw 12V AC/DC	2/162
2	red, white	102496	Ex9PD2rw 24V AC/DC	2/162
2	red, white	102497	Ex9PD2rw 110V AC/DC	2/162
2	red, white	102498	Ex9PD2rw 230V AC/DC	2/162

Signal lamps Ex9PD

2-LED version



No of LEDs	Colour	Article No.	Type	Packing
2	yellow, yellow	102499	Ex9PD2yy 6.3V AC/DC	2/162
2	yellow, yellow	102500	Ex9PD2yy 12V AC/DC	2/162
2	yellow, yellow	102501	Ex9PD2yy 24V AC/DC	2/162
2	yellow, yellow	102502	Ex9PD2yy 110V AC/DC	2/162
2	yellow, yellow	102503	Ex9PD2yy 230V AC/DC	2/162
2	yellow, blue	102504	Ex9PD2yb 6.3V AC/DC	2/162
2	yellow, blue	102505	Ex9PD2yb 12V AC/DC	2/162
2	yellow, blue	102506	Ex9PD2yb 24V AC/DC	2/162
2	yellow, blue	102507	Ex9PD2yb 110V AC/DC	2/162
2	yellow, blue	102508	Ex9PD2yb 230V AC/DC	2/162
2	yellow, white	102509	Ex9PD2yw 6.3V AC/DC	2/162
2	yellow, white	102510	Ex9PD2yw 12V AC/DC	2/162
2	yellow, white	102511	Ex9PD2yw 24V AC/DC	2/162
2	yellow, white	102512	Ex9PD2yw 110V AC/DC	2/162
2	yellow, white	102513	Ex9PD2yw 230V AC/DC	2/162
2	blue, blue	102514	Ex9PD2bb 6.3V AC/DC	2/162
2	blue, blue	102515	Ex9PD2bb 12V AC/DC	2/162
2	blue, blue	102516	Ex9PD2bb 24V AC/DC	2/162
2	blue, blue	102517	Ex9PD2bb 110V AC/DC	2/162
2	blue, blue	102518	Ex9PD2bb 230V AC/DC	2/162
2	blue, white	102519	Ex9PD2bw 6.3V AC/DC	2/162
2	blue, white	102520	Ex9PD2bw 12V AC/DC	2/162
2	blue, white	102521	Ex9PD2bw 24V AC/DC	2/162
2	blue, white	102522	Ex9PD2bw 110V AC/DC	2/162
2	blue, white	102523	Ex9PD2bw 230V AC/DC	2/162
2	white, white	102524	Ex9PD2ww 6.3V AC/DC	2/162
2	white, white	102525	Ex9PD2ww 12V AC/DC	2/162
2	white, white	102526	Ex9PD2ww 24V AC/DC	2/162
2	white, white	102527	Ex9PD2ww 110V AC/DC	2/162
2	white, white	102528	Ex9PD2ww 230V AC/DC	2/162

Signal lamps Ex9PDe



- Installation Signal Lamps
- Meet requirements of IEC / EN 60947-5-1
- LED technology
- Operating voltage 24, 48 and 230 V AC/DC
- Width 1 MU
- 1, 2 and 3-LED versions
- Dual-colour LED in Ex9PD1e, Ex9PD2e

Installation signal lamps Ex9PDe are designed and tested according to standard IEC / EN 60947-5-1. They are based on LED technology and suitable e.g. for circuit status indication.

There are available versions with rated operating voltage 24, 48 and 230 V AC/DC, with one or two dual-colour (green/red) LEDs. The last variant with three red LEDs is available with operating voltage 230/400 V AC. This kind of signal lamp is used mainly for phase voltage presence check in 3-phase connections.

All versions are designed as 1 module unit width devices including the three LED version. Used internal technology of LED lights ensures very low power consumption during operations and very high lifetime.

Type Key

Ex9	PD	2	e	230V	AC/DC
Product family	Product	LEDs	LED's colour	Rated voltage	Current character
Ex9	PD: Installation Signal Lamps	1, 2	red/green (dual-colour)	24, 48, 230 V	AC/DC
		3	red	230/400 V	AC

Certification marks



Signal lamps Ex9PDe

1-LED version, dual-colour LED

- Priority colour red (when both colours are connected, the red one is ON only)



No. of LEDs	Colour	Article No.	Type	Packing
1	red/green	106307	Ex9PD1e 24V AC/DC	2/162
1	red/green	106308	Ex9PD1e 48V AC/DC	2/162
1	red/green	106309	Ex9PD1e 230V AC/DC	2/162

2-LED version, dual-colour LEDs

- Priority colour red (when both colours are connected, the red one is ON only)



No. of LEDs	Colour	Article No.	Type	Packing
2	red/green	106310	Ex9PD2e 24V AC/DC	2/162
2	red/green	106311	Ex9PD2e 48V AC/DC	2/162
2	red/green	106312	Ex9PD2e 230V AC/DC	2/162

3-LED version, red LED colour



No. of LEDs	Colour	Article No.	Type	Packing
3	red	106313	Ex9PD3e 230/400V AC	2/162

Timers and light intensity delay

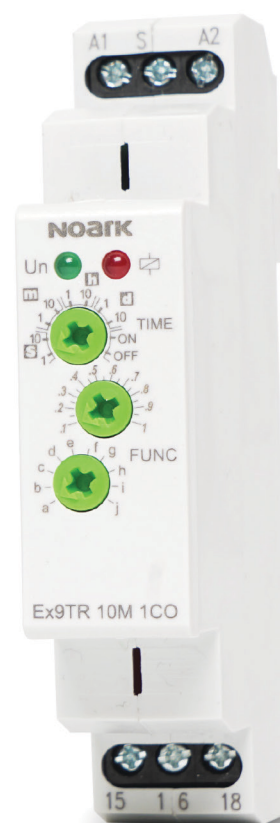

Timers and light intensity delay

Professional Tips



- 1 5 year warranty
- 2 Analogue and digital version
- 3 Adjustable time
- 4 Manual control switch
- 5 Adjustable light sensitivity
- 6 Various types of time relays
- 7 External brightness sensor
- 8 Easy mounting on DIN rail

Analogue Time Switches Ex9TAM2



- Installation Analogue Time Switches
- Operating voltage U_e 230 V AC
- Quartz or grid synchronous time basis
- Daily program of integrated time switch
- Shortest switching time 15 min.
- 1-module width version

Installation Analogue Time Switches Ex9TAM2 are suitable for residential and industrial applications. They will find their use everywhere where it is needed to save energy costs and to switch the circuit in regular daily cycles. Shortest switching time is 15 minutes.

Time switches are offered in 1-modules width version with Quartz or grid synchronous time basis.

Type Key

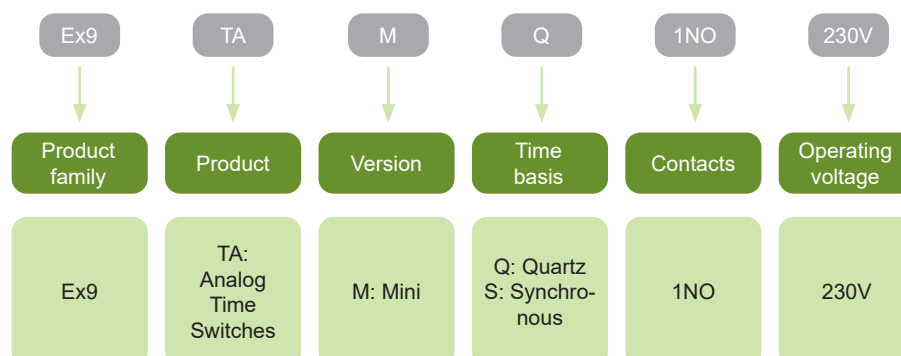

Certification marks



Analogue Time Switches Ex9TAM2

Analogue Time Switches - mini version

- Synchronous or Quartz time basis
- Daily switching program
- Shortest switching time 15 min.
- Width 1MU



Channels	Contacts	Time basis	Article No.	Type	Packing
1	1NO	Synchronous	111721	Ex9TAMS2 1NO 230V	1/10/60
1	1NO	Quartz	111722	Ex9TAMQ2 1NO 230V	1/10/60

Miniature Digital Time Switches Ex9TDM



- Installation Miniature Digital Time Switches
- Weekly and Holiday switching program
- Switching status LCD display
- Quartz time base
- Auto summer and wintertime change
- Miniature (1MU) width versions

Installation Miniature Digital Time Switches Ex9TDM are suitable for time control and switching in various residential and industrial applications. They are fully programmable in every 1 minute and they are working in weekly and holiday switching program.

With these properties, it is possible to set the switching pattern exactly to as required and save energy costs. These Time Switches are offered in 1MU wide miniature version.

To determine the current status and setting up the time switch each device is equipped with LCD display.

Type Key

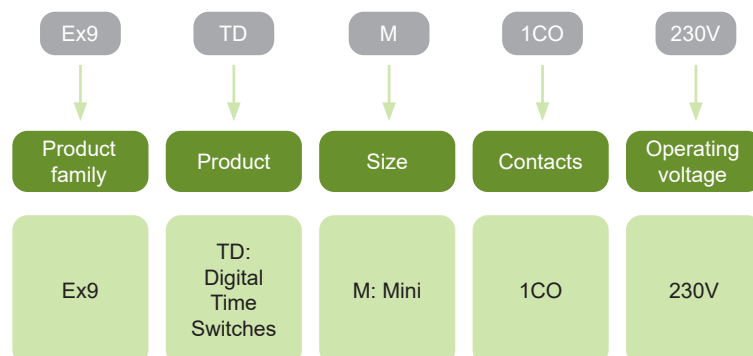

Certification marks



Miniature Digital Time Switches Ex9TDM

Digital Time Switches - mini version

- Programmable every 1 min.
- Shortest switching time 1 min.
- Weekly and Holiday switching program
- Quartz time basis
- Width 1MU



Channels	Contacts	Comfort functions	Article No.	Type	Packing
1	1CO	-	103509	Ex9TDM 1CO 230V	1

Digital Time Switches Ex9DTS



- Installation Digital Time Switches
- Daily, weekly and holiday switching program
- Comfort functions allow additional monthly and yearly switching program
- Switching status LCD display
- Auto summer and wintertime change
- Standard (2MU) width versions
- Sealable front cover

Installation Digital Time Switches Ex9DTS are suitable for time control and switching in various residential and industrial applications. They are fully programmable in every 1 minute and they are working in weekly and holiday switching program.

With these properties, it is possible to set the switching pattern exactly to as required and save energy costs.

To determine the current status and setting up the time switch each device is equipped with LCD display.

Type Key

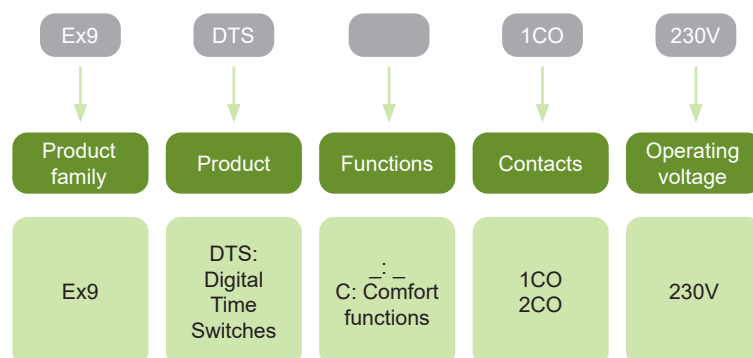

Certification marks



Digital Time Switches Ex9DTS

Digital Time Switches

- Programmable every 1 min.
- Daily, weekly and holiday switching program
- Comfort functions (Ex9DTSC): possibility of monthly and yearly switching program
- 100 memory spaces, 1 sec. shortest switching time, pulse and cycle output, 10 years power reserve
- Width 2MU



Channels	Contacts	Comfort functions	Article No.	Type	Packing
1	1CO	-	110554	Ex9DTS 1CO 230V	1
2	2CO	-	110555	Ex9DTS 2CO 230V	1
1	1CO	yes	110556	Ex9DTSC 1CO 230V	1
2	2CO	yes	110557	Ex9DTSC 2CO 230V	1

Staircase Switches Ex9SS

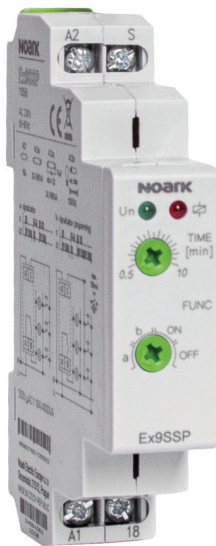

- Installation Staircase Switches
- Rated operating voltage 230 V AC
- Time adjustment range from 0.5 to 10 min.
- Manual control switch on the front side
- Basic and programmable version
- 3-wire or 4-wire connection

Installation Staircase Switches Ex9SS are suitable mainly for light switching in many various residential, office and industrial applications, e.g. lighting of staircases or entrance areas.

Their AUTO switching time can be adjusted up to 10 minutes using rotary switch on the front side, or they can be manually switched in ON/OFF states by the another rotary switch.

Programmable Installation Staircase Switches Ex9SSP have the same use as Ex9SSB, but with additional functions:

- a - Staircase automat with delayed return and signaling before switching off by two flashes of light
- b - Programmable staircase automat with delayed return and signaling before switching off by two flashes of light. Programmable delay is enabling time prolongation by number of button pressing, e.g. if the set period is 5 min and you press button 3 times, the time period of switch ON will be 15 min (maximum prolong time - 30 min). Reset of this period can be done by pressing the button for more than 2 sec.

Type Key

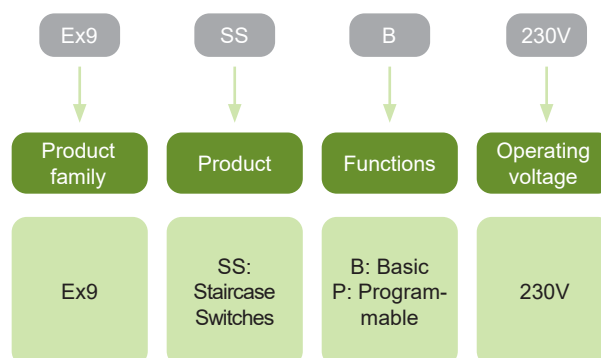

Certification marks



Staircase Switches Ex9SS

Basic version

- Time adjustment range from 0.5 to 10 minutes
- Manual control switch
- Functions ON / OFF / AUTO
- Timing can be terminated by long pressing the control button (> 2sec) - AUTO function
- Possibility to connect control buttons with glow lamps (max. 100mA)



Operating voltage U _e	Contacts	Functions	Article No.	Type	Packing
230 V AC	1 CO	Basic	110558	Ex9SSB 230V	1

Programmable version

- Time adjustment range from 0.5 to 10 minutes per press on program
- Manual control switch
- Additional programming functions „a“ and „b“
 - a - Staircase automat with delayed return and signaling before switching off by two flashes of light
 - b - Programmable staircase automat with delayed return and signaling before switching off by two flashes of light. Programmable delay is enabling time prolongation by number of button pressing, e.g. if the set period is 5 min and you press button 3 times, the time period of switch ON will be 15 min. (maximum prolong time 30 min.)
- Possibility to switch off before time (reset) by long pressing of button (>2sec)
- Possibility to connect control buttons with glow lamps (max. 100mA)



Operating voltage U _e	Contacts	Functions	Article No.	Type	Packing
230 V AC	1 NO	Programmable	110559	Ex9SSP 230V	1

Light Intensity Switches Ex9LAS and Ex9LDS



- Rated operating voltage 230 V AC
- Analogue and digital version
- Without and with integrated time switch
- Random switching mode (Ex9LDS)
- Adjustable light sensitivity up to 50 000 lx
- External brightness sensor with IP44 rating

Light Intensity Switches Ex9LAS and Ex9LDS are used for light switching according to actual daylight intensity (Ex9LDS device also according to time), so the light fixtures are switched only if necessary and it can save money for consumed energy.

This switch can automatically change between summer and wintertime. It operates in daily, weekly or yearly switching program and can be connect to light control systems with other devices.

External brightness sensor is included in the scope of delivery.

Type Key

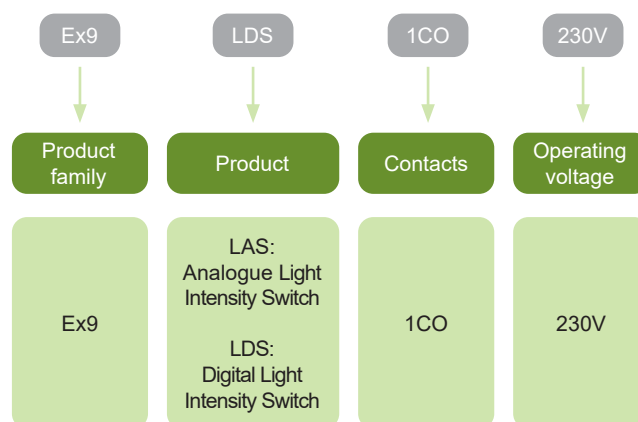

Certification marks



Light Intensity Switches Ex9LAS and Ex9LDS

Analogue version

- Two light adjustment ranges LUX1 (1 - 100 lx) and LUX2 (100 - 50 000 lx), TEST for permanent change of contact
- Adjustable time delay (0 - 2 min) to eliminate short term fluctuation in illumination
- LED indication on front of the device
- Surface-mounted brightness sensor in the scope of delivery



Channels	Width	Article No.	Type	Packing
1	1MU	110560	Ex9LAS 1CO 230V	1

Digital version

- Combination of time switch and light intensity switch - time switch is superior
- Daily, weekly and yearly program of integrated time switch
- Light adjustment range 10 - 50 000 lx
- Random switching function
- Sealable transparent cover of front panel
- Surface-mounted brightness sensor in the scope of delivery



Channels	Width	Article No.	Type	Packing
1	2MU	110561	Ex9LDS 1CO 230V	1

Time relays Ex9TR



- Rated operating voltage 12 - 240 V AC/DC
- Adjustable time range
- Manual control switches on the front side
- Types of time relay
 - Single-function: Delay ON
 - Single-function: Interval ON
 - Single-function: Flasher
 - Multifunction: 10 functions
 - Asymmetric cycler
 - Delay starter Star / Delta

Ex9TR time relays are used in automation, control and regulation (ventilation, lighting, heating, etc.). All our time relays can be powered by universal voltage 12 - 240 V AC/DC. The devices have manual control switches on the front for setting the time.

Types of time relay:

- **Single-function time relay** are offered in 3 types (Delay ON, Interval ON and Flasher).
- **Multifunction time relay** contains 10 adjustable functions with 1 or 3 changeover contacts.
- **Asymmetric cycler** with the possibility of setting the closing and opening time.
- **Delay starter Star / Delta** designed for starting motors.

Type Key

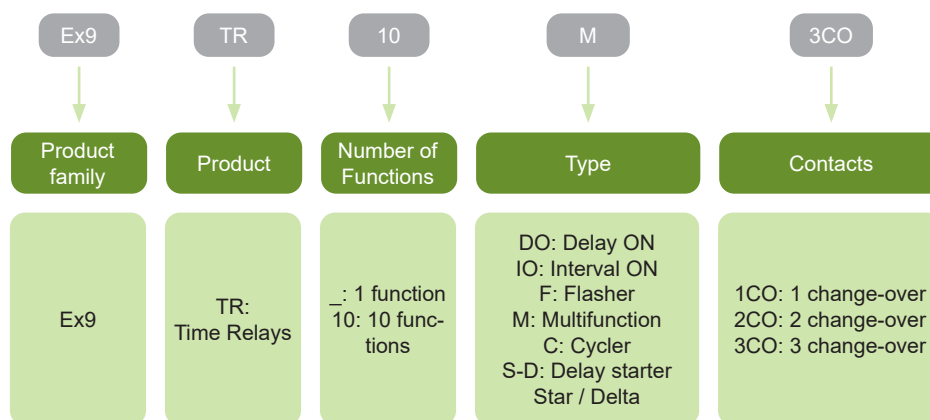

Certification marks



Time relays Ex9TR

Single-function time relays

- Universal supply voltage 12 - 240 V AC/DC
- Adjustable time from 0.1 s to 100 h in 10 different intervals
- Fine set the time in the selected time interval (1-10)
- 3 types of relay : DO Delay ON, IO Interval ON, F Flasher
- Control input „S“ to pause timing



Supply voltage U_e	Function	Contacts	Article No.	Type	Packing
12 - 240 V AC/DC	Delay ON	1 CO	111731	Ex9TR DO 1CO	1/10/120
12 - 240 V AC/DC	Interval ON	1 CO	111737	Ex9TR IO 1CO	1/10/120
12 - 240 V AC/DC	Flasher	1 CO	111738	Ex9TR F 1CO	1/10/120

Multifunction time relays

- Universal supply voltage 12 - 240 V AC/DC
- Adjustable time from 0.1 s to 10 days in 10 different intervals
- Fine set the time in the selected time interval (1 - 10)
- 10 setable functions
- Versions with 1x 16 A changeover contact or 1x 16 A + 2x 8 A changeover contacts



Supply voltage U_e	Function	Contacts	Article No.	Type	Packing
12 - 240 V AC/DC	Multifunction	1 CO	111732	Ex9TR 10M 1CO	1/10/120
12 - 240 V AC/DC	Multifunction	3 CO	111733	Ex9TR 10M 3CO	1/10/120

Asymmetric cycler

- Universal supply voltage 12 - 240 V AC/DC
- Adjustable time from 0.1 s to 100 days in 10 different intervals
- Fine set the time in the selected time interval (1 - 10)
- Possibility of setting the cycle time interval and the gap
- Cycler starting with a pulse or a gap



Supply voltage U_e	Function	Contacts	Article No.	Type	Packing
12 - 240 V AC/DC	Cycler	1 CO	111729	Ex9TR C 1CO	1/10/120

Time relays Ex9TR

Delay starter Star/Delta

- Universal supply voltage 12 - 240 V AC/DC
- Adjustable time from 0.1 s to 100 days in 10 different intervals
- Fine set the time in the selected time interval (1 - 10)
- Setting the time in the star connection t1 and setting the delay t2 between the star/delta switch



Supply voltage U _e	Function	Contacts	Article No.	Type	Packing
12 - 240 V AC/DC	Star/Delta	2 CO	111730	Ex9TR S-D 2CO	1/10/120

Notes

A large grid of dashed lines for taking notes, covering most of the page area below the header.

Other installation devices



Other Installation Devices

Professional Tips

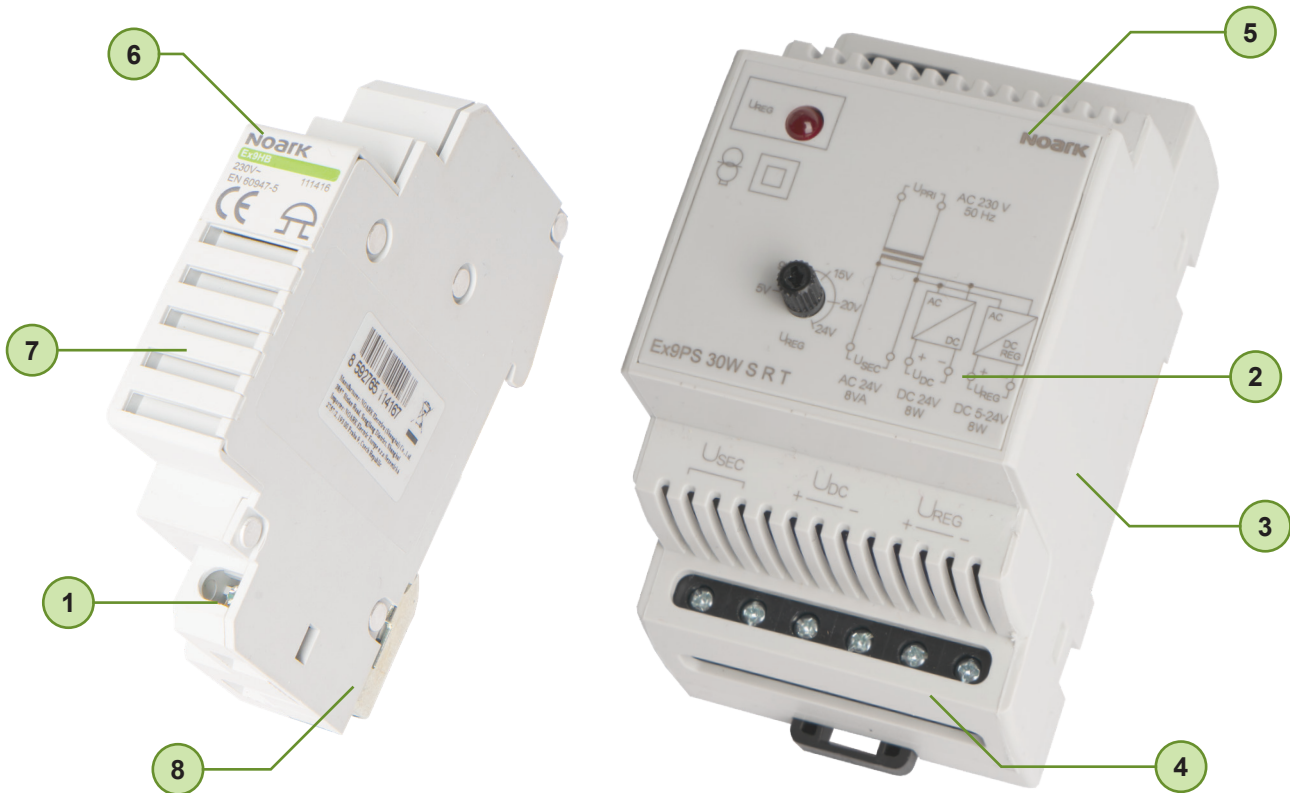

- 1 5 year warranty
- 2 Power range from 8W up to 100W
- 3 Intergrated internal protections
- 4 Output voltage from 5V DC up to 24V DC

- 5 Version with built-in transformer
- 6 12V or 230V AC versions
- 7 Sound level 75 dB
- 8 Easy mounting on DIN rail

DIN Rail Bell Ex9HB



- DIN Rail Bell according to IEC/EN 60947-5
- Rated working voltage 12 V or 230 V AC
- Rated frequency 50 Hz
- Sound level 75 dB
- 1-module width
- Suitable for applications from -5 to +40°C

Ex9HB DIN rail bell is suitable mainly for household applications as a door bell or can be used as alarm. This bell is intended to be installed in enclosure on DIN rail, which brings advantage of not disturbing original design of your home. To cover whole building with ringing sound the sound level is minimally 75 dB.

Type Key

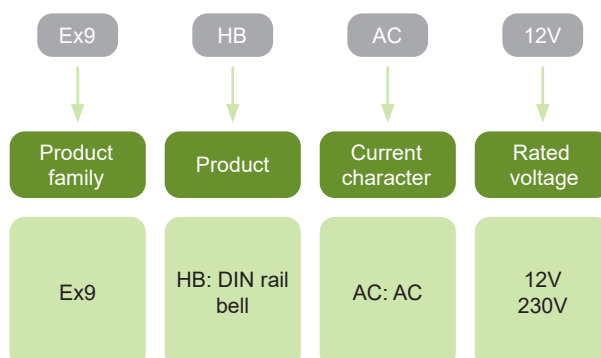

Certification marks



DIN Rail Bell Ex9HB

DIN Rail Bell

- Rated working voltage 12 V or 230 V AC
- Rated frequency 50 Hz
- Sound level 75 dB
- 1-module width



Rated voltage	Article No.	Type	Packing
12 V	111415	Ex9HB AC12V	1/12/192
230 V	111416	Ex9HB AC230V	1/12/192

Power supplies Ex9PS



- Power range from 8 W up to 100 W
- Version with built-in transformer for small output AC voltage
- Types of output voltage
 - 12 V DC stabilized
 - 24 V DC stabilized
 - 12-24 V DC stabilized
 - 5-24 V DC stabilized
 - 24 V DC nonstabilized
 - 24 V AC
- integrated internal protections

DIN-rail mounted power supplies Ex9PS provide a convenient solution for powering DC operated devices like bells, videophones, vending machines, security systems, etc. Since these power supplies are air convection cooled, no cooling fans are needed. Output voltages from these supplies range from 5 V up to 24 V DC with power ratings from 8 W up to 100 W.

All power supplies have several built-in protections.

Type key

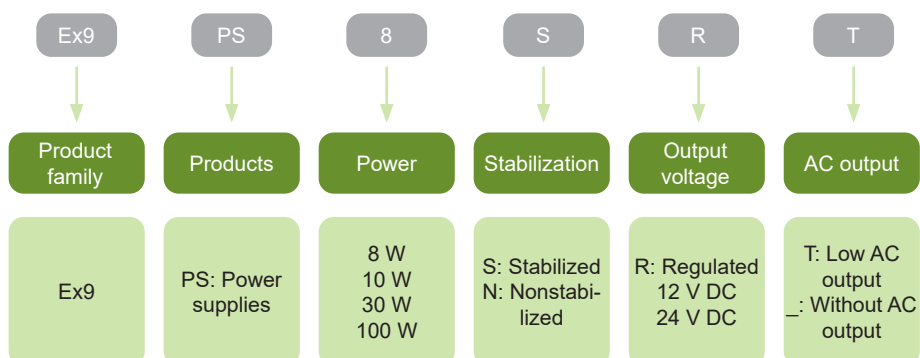

Certification marks



Power supplies Ex9PS

Power supplies

- Stabilized voltage output
- Version with 12 V DC, 24 V DC and adjustable (12-24 V DC) stabilized output
- The output current is limited by an electronic fuse, when the maximum current is exceeded, the source switches off, after a short delay it switches on again
- Thermal protection - in case of thermal overload the source switches off, after cooling it switches on again



Operating voltage	Output voltage	Power	Stabilized output	Article No.	Type	Packing
184-250 V AC	24 V DC	10 W	YES	111723	Ex9PS 10W S 24VDC	1/120
100-250 V AC	24 V DC	30 W	YES	111725	Ex9PS 30W S 24V DC	1/50
100-250 V AC	12-24 V DC	30 W	YES	111726	Ex9PS 30W S R	1/50
100-250 V AC	12 V DC	100 W	YES	111724	Ex9PS 100W S 12V DC	1/32
100-250 V AC	24 V DC	100 W	YES	111735	Ex9PS 100W S 24V DC	1/32

Power supplies with built-in transformer

- Built-in transformer for 24 V AC output
- Type Ex9PS 8W N 24V AC / DC T offers 24 V AC / DC unstabilized and is protected by a fuse
- Type Ex9PS 8W S R T offers 5-24 V DC stabilized and 24 V AC / DC unstabilized and is protected by an electronic fuse



Operating voltage	Output voltage	Power	Stabilized output	Article No.	Type	Packing
230 V AC	5-24 V DC	8 W	YES	111727	Ex9PS 8W S R T	1/50
230 V AC	24 V DC	8 W	NO	111728	Ex9PS 8W N 24V AC/DC T	1/50

Technical Data

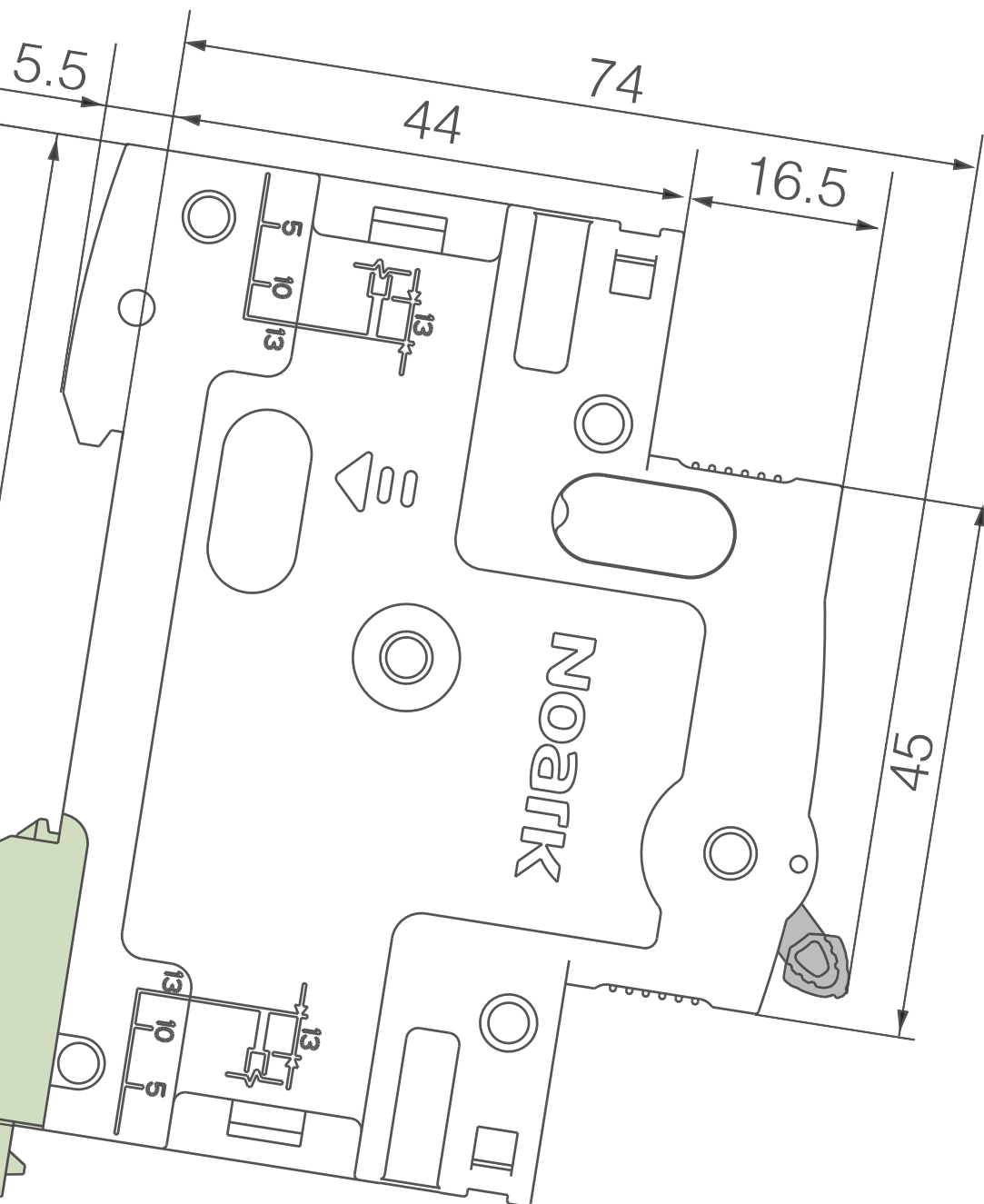

Content

Technical Data

Miniature Circuit Breakers

Ex9BH MCBs up to 63 A, 10 kA	204
Ex9BN MCBs up to 63 A, 6 kA	208
Ex9B40J MCBs up to 40 A	212
Ex9B125 MCBs up to 100 A	214
Ex9PN 1P+N single-module unit MCBs, 6 kA	218
Ex9BP-JX DC MCBs up to 63 A	221

Fuse holders and disconnectors

Ex9F fuse holders	224
Ex9FP DC fuse disconnectors	226
Ex9FS fuse switch disconnectors	228

Isolators

Ex9I125 isolators up to 125 A	230
Ex9I40 single-module unit isolators up to 40 A	232
Ex9BI isolators up to 63 A with accessories	234

Residual Current Devices

Ex9L-H RCCBs up to 63 A, 10 kA	236
Ex9L-N RCCBs up to 63 A, 6 kA	239
Ex9CL-100 RCCBs up to 100 A, 10 kA	242
Ex9LB63 B type RCCBs up to 63 A, 10 kA	246
Ex9BL-H RCBOs up to 40 A, 10 kA	249
Ex9BL-N RCBOs up to 40 A, 6 kA	252
Ex9NLE RCBOs up to 40 A, 6 kA	255
Ex9NL-N RCBO up to 40 A, 6 kA	258
Ex9LE RCD add-on blocks.....	261

Energy meters

Ex9EM energy meters	263
Ex9EMS smart energy meters	266
CT current transformers	271

Motor Protective Circuit Breakers

Ex9SN25B motor protective circuit breakers to 25 A	274
--	-----

Accessories for Installation Devices

Accessories for devices of Ex9B, Ex9PN line	278
Accessories for devices of Ex9SN25B line	286
Accessories for devices of Ex9NLE, Ex9NL-N line	292

Surge Protection Devices

Ex9UE1+2 SPDs Type 1+2, 25 kA	298
Ex9UE1+2 SPDs Type 1+2, 12,5 kA	301
Ex9UE2 SPDs Type 2	307
Ex9UE3 SPDs Type 3	310

Installation relays and contactors

Ex9CH20 installation relays	312
Ex9CH installation contactors	314
Ex9CHM installation contactors with manual operation	316
Ex9JU impulse relays	319

Content

Switches and signal lamps

Ex9BT change-over switches	321
Ex9PD signal lamps	323
Ex9PDe signal lamps	325

Timers and light intensity switches

Ex9TAM2 analogue timers	327
Ex9TDM miniature digital timers	329
Ex9DTS digital timers	331
Ex9SS staircase switches	334
Ex9LAS analogue light intensity switches	337
Ex9LDS digital light intensity switches	340
Ex9TR time relays.....	343

Other installation devices

Ex9HB din rail bell.....	355
Ex9PS power supplies.....	357

Technical Data Ex9BH

Miniature Circuit Breakers, 10 kA

General parameters

Very high limiting of short circuit current

Suitable for household as well as industrial applications

Accessories

Auxiliary contacts	AX3111, AX3122	100540, 100542
Alarm contact	AL3111	100541
Auxiliary and alarm contact	AXL31	100543
Shunt trip releases	SHT31, SHT3111	100544-100546, 100547-100549
Undervoltage releases	UVT31, UVT3101, UVT3110	100550-100551, 100552-100553, 100554-100555
Oversvoltage release	OVT31 280V AC±5%	100556

Max. number of installed accessories is 3 pcs of one contact units (AX3111, AL3111) or 2 pcs of two contact units (AX3122, AXL31) and 2 pcs of releases (SHT31, UVT31, OVT31)

RCD add-on blocks	Ex9LE
-------------------	-------

Electrical parameters

Tested according to	IEC/EN 60898-1, IEC/EN 60947-2 (partially)
Rated op. voltage U_e	240/415 V AC
	72 V DC per pole (1P, 2P), 48 V DC per pole (3P, 4P)
Minimum voltage	12 V AC/DC
Rated impulse withstand voltage U_{imp} according IEC 60898-1	6 kV
Rated impulse withstand voltage U_{imp} according IEC 60947-2	6 kV
Rated insulation voltage U_i	690 V AC
Rated frequency	50/60 Hz
Rated breaking capacity I_{cn} according IEC 60898-1	10 kA
Rated breaking capacity I_{cn} according IEC 60947-2	15 kA (1 — 32 A) 10kA (40 — 63 A)
Rated current	1 — 63 A
Tripping characteristics	B, C, D
Mechanical service life	20 000 operation cycles
Electrical service life	10 000 operation cycles
Selectivity class	3
Utilization category	A
Max. back-up fuse	max. 125 A gG
Line voltage connection	arbitrary above or below

Wiring diagrams

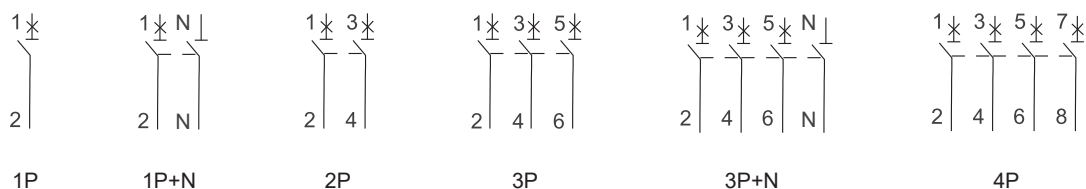

Technical Data Ex9BH

Miniature Circuit Breakers, 10 kA

Mechanical parameters

Device width	18 mm (per pole)
Device height	83 mm (89 mm including rail clip)
Frame size	45 mm
Mounting	easy fastening onto 35 mm device rail (DIN)
Degree of protection	IP20
Terminals	combined lift + open mouthed
Terminal capacity	1 — 35 mm ²
Fastening torque of terminals	2 — 3.5 Nm
Busbar thickness	0.8 — 2 mm
Ambient temperature	-30 — +70 °C
Altitude	≤ 2000 m
Relative humidity	≤ 95 %
Resistance to humidity and heat	class 2
Pollution degree	3
Installation class	III
Weight	0.12 kg (per pole)

Dimensions

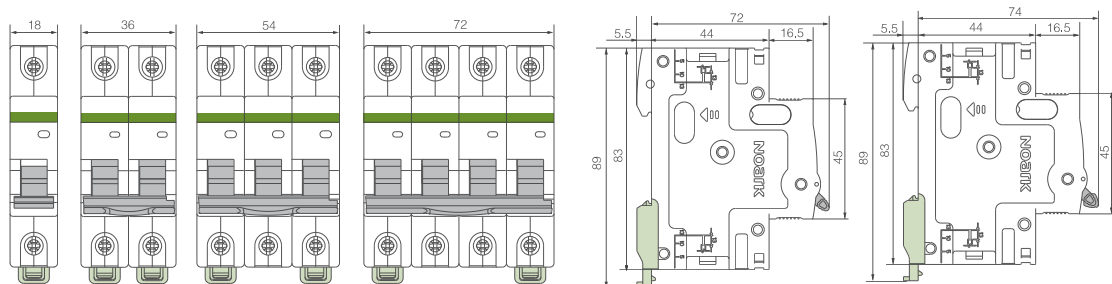

Technical Data Ex9BH

Miniature Circuit Breakers, 10 kA

Tripping characteristics

Characteristic B

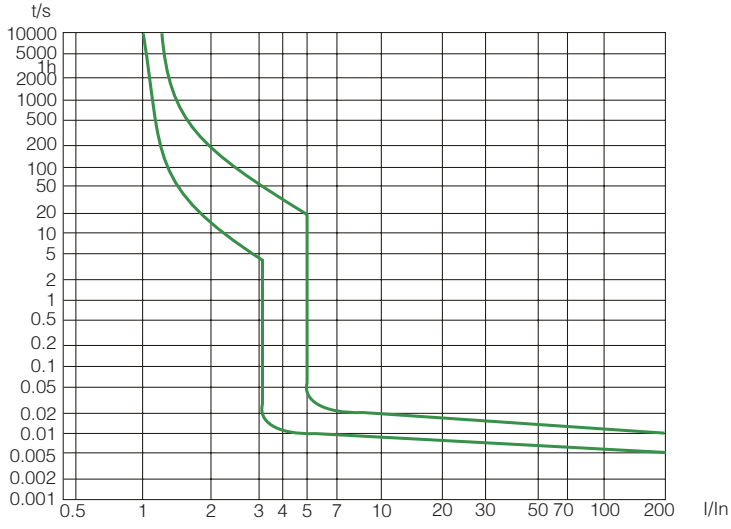

Characteristic C

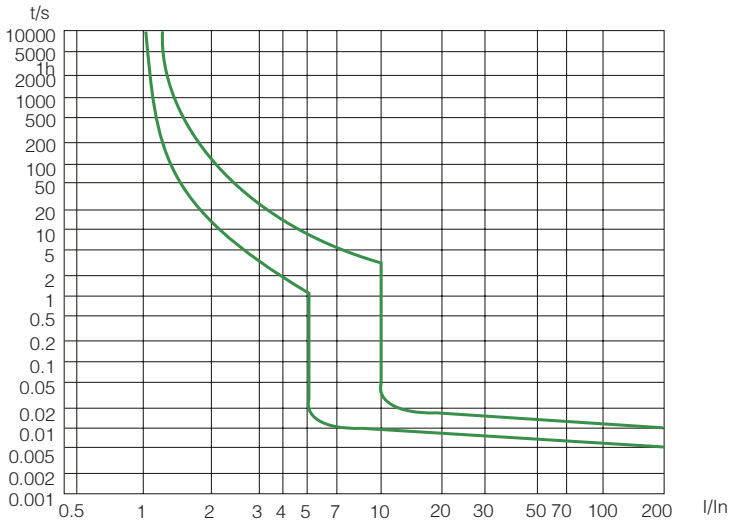

Characteristic D

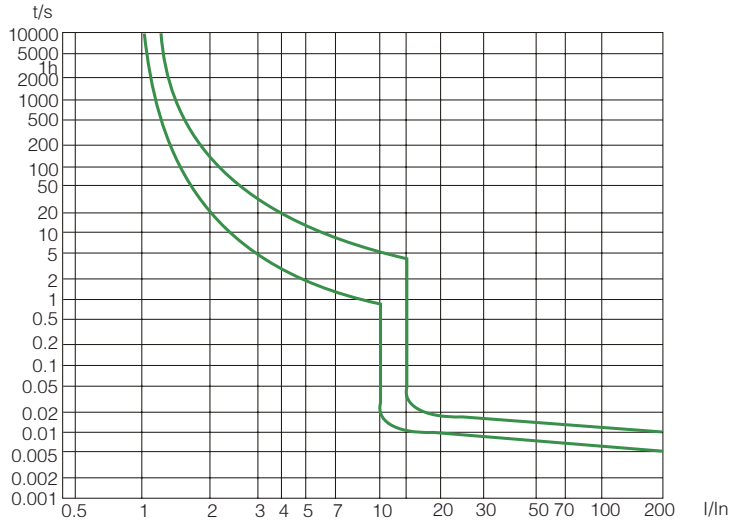

Technical Data Ex9BH

Miniature Circuit Breakers, 10 kA













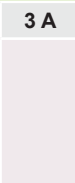

Dependence of Tripping Characteristics on Ambient Temperature

T [°C]	I _n (T) [A]														
	1 A	2 A	3 A	4 A	6 A	8 A	10 A	13 A	16 A	20 A	25 A	32 A	40 A	50 A	63 A
-30	1.3	2.5	3.8	5.1	7.6	10.2	13.6	16.8	20.5	25.3	31.1	40.5	51.0	64.0	82.0
-25	1.2	2.4	3.7	4.9	7.4	9.9	13.4	16.5	20.0	25.0	30.5	39.8	50.0	63.0	80.7
-20	1.2	2.4	3.6	4.8	7.3	9.7	13.1	16.3	19.8	24.5	30.0	39.2	49.2	62.0	79.2
-15	1.2	2.4	3.5	4.8	7.2	9.5	12.8	15.9	19.4	24.0	29.5	38.5	48.4	60.8	77.8
-10	1.2	2.3	3.5	4.7	7.1	9.3	12.5	15.7	19.0	23.7	29.0	37.9	47.5	59.8	76.3
-5	1.2	2.3	3.4	4.7	7.0	9.2	12.3	15.4	18.7	23.2	28.5	37.2	46.7	58.6	74.7
0	1.1	2.2	3.4	4.5	6.8	9.0	12.0	15.0	18.4	22.8	28.0	36.5	45.8	57.4	73.2
5	1.1	2.2	3.3	4.4	6.6	8.9	11.7	14.7	18.0	22.4	27.5	35.8	45.0	56.3	71.6
10	1.1	2.1	3.3	4.3	6.5	8.7	11.4	14.3	17.6	21.9	27.0	35.0	44.0	55.0	70.0
15	1.1	2.1	3.2	4.3	6.4	8.5	11.0	14.0	17.2	21.5	26.5	34.3	43.0	53.8	68.3
20	1.0	2.1	3.2	4.2	6.3	8.3	10.7	13.7	16.8	21.0	26.0	33.6	42.0	52.6	66.6
25	1.0	2.0	3.0	4.1	6.2	8.2	10.4	13.4	16.4	20.5	25.5	32.8	41.0	51.3	64.8
30	1	2	3	4	6	8	10	13	16	20	25	32	40	50	63
35	0.99	2.00	3.00	3.9	5.9	7.9	9.9	12.8	16.0	20.0	25.0	32.0	39.0	49.0	62.0
40	0.97	1.90	2.90	3.9	5.8	7.8	9.7	12.5	15.0	19.0	24.0	31.0	39.0	48.0	61.0
45	0.95	1.90	2.80	3.8	5.7	7.7	9.5	12.2	15.0	19.0	24.0	30.0	38.0	47.0	60.0
50	0.93	1.90	2.80	3.7	5.6	7.6	9.3	12.0	15.0	19.0	23.0	30.0	37.0	46.0	58.0
55	0.91	1.80	2.80	3.6	5.5	7.5	9.0	11.7	14.0	18.0	23.0	29.0	36.0	44.0	57.0
60	0.91	1.80	2.70	3.5	5.4	7.2	8.8	11.5	14.0	18.0	22.0	28.0	35.0	42.0	55.0
65	0.91	1.80	2.70	3.5	5.3	7.1	8.6	11.2	13.0	17.0	21.0	28.0	34.0	40.0	52.0
70	0.91	1.80	2.70	3.5	5.3	6.9	8.6	11.0	13.0	17.0	21.0	27.0	33.0	38.0	50.0

Power loss per pole

I _n [A]	1 A	2 A	3 A	4 A	6 A	8 A	10 A	13 A	16 A	20 A	25 A	32 A	40 A	50 A	63 A
P [W]	1.8	2.1	1.9	2.0	2.5	1.2	1.8	3.1	2.3	2.4	3.5	3.8	4.7	4.7	6.2

Toggle colours meaning

I _n [A]	1 A	2 A	3 A	4 A	6 A	8 A	10 A	13 A	16 A	20 A	25 A	32 A	40 A	50 A	63 A
Colour															

Technical Data Ex9BN

Miniature Circuit Breakers, 6 kA

General parameters

Very high limiting of short circuit current		
Suitable for household as well as industrial applications		
Accessories		
Auxiliary contacts	AX3111, AX3122	100540, 100542
Alarm contact	AL3111	100541
Auxiliary and alarm contact	AXL31	100543
Shunt trip releases	SHT31, SHT3111	100544-100546, 100547-100549
Undervoltage releases	UVT31, UVT3101, UVT3110	100550-100551, 100552-100553, 100554-100555
Oversvoltage release	OVT31 280V AC±5%	100556
Max. number of installed accessories is 3 pcs of one contact units (AX3111, AL3111) or 2 pcs of two contact units (AX3122, AXL31) and 2 pcs of releases (SHT31, UVT31, OVT31)		
RCD add-on blocks	Ex9LE	

Electrical parameters

Tested according to	IEC/EN 60898-1, IEC/EN 60947-2 (partially)
Rated op. voltage U_e	240/415 V AC
	72 V DC per pole (1P, 2P), 48 V DC per pole (3P, 4P)
Minimum voltage	12 V AC/DC
Rated impulse withstand voltage U_{imp} according IEC 60898-1	6 kV
Rated impulse withstand voltage U_{imp} according IEC 60947-2	6 kV
Rated insulation voltage U_i	690 V AC
Rated frequency	50/60 Hz
Rated breaking capacity I_{cn} according IEC 60898-1	6 kA
Rated breaking capacity I_{cn} according IEC 60947-2	10kA
Rated current	1 — 63 A
Tripping characteristics	B, C, D
Mechanical service life	20 000 operation cycles
Electrical service life	10 000 operation cycles
Selectivity class	3
Utilization category	A
Max. back-up fuse	max. 125 A gG
Line voltage connection	arbitrary above or below

Wiring diagrams

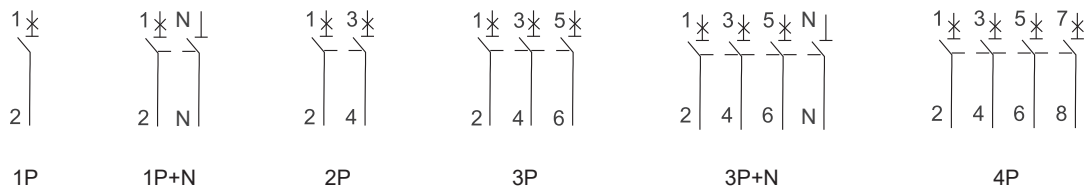

Technical Data Ex9BN

Miniature Circuit Breakers, 6 kA

Mechanical parameters

Device width	18 mm (per pole)
Device height	83 mm (89 mm including rail clip)
Frame size	45 mm
Mounting	easy fastening onto 35 mm device rail (DIN)
Degree of protection	IP20
Terminals	combined lift + open mouthed
Terminal capacity	1 — 35 mm ²
Fastening torque of terminals	2 — 3.5 Nm
Busbar thickness	0.8 — 2 mm
Ambient temperature	-30 — +70 °C
Altitude	≤ 2000 m
Relative humidity	≤ 95 %
Resistance to humidity and heat	class 2
Pollution degree	3
Installation class	III
Weight	0.12 kg (per pole)

Dimensions

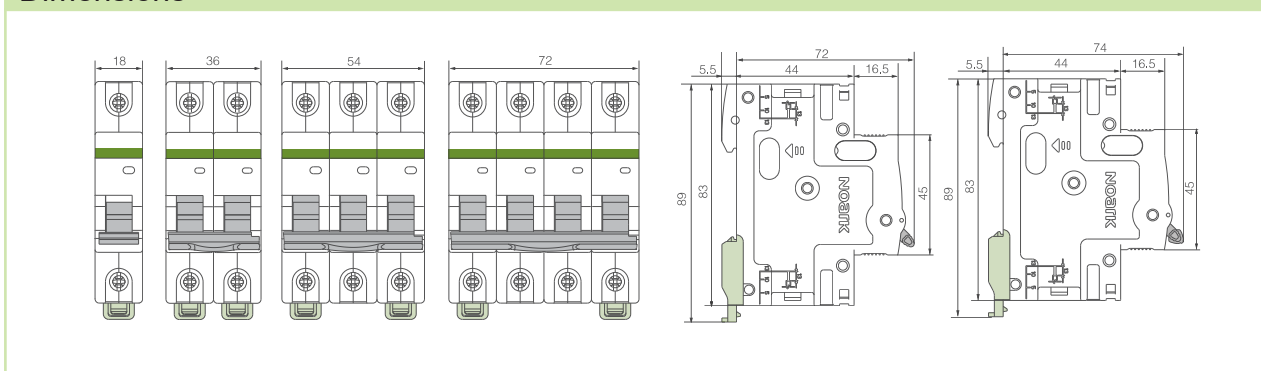

Technical Data Ex9BN

Miniature Circuit Breakers, 6 kA

Tripping characteristics

Characteristic B

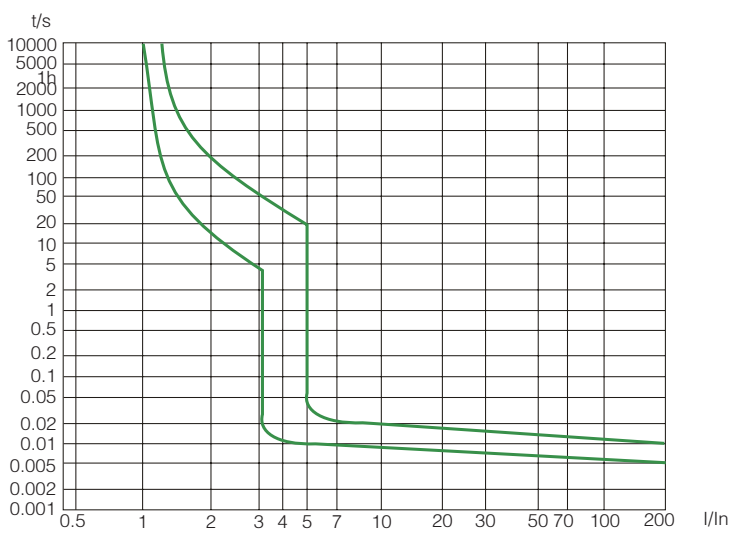

Characteristic C

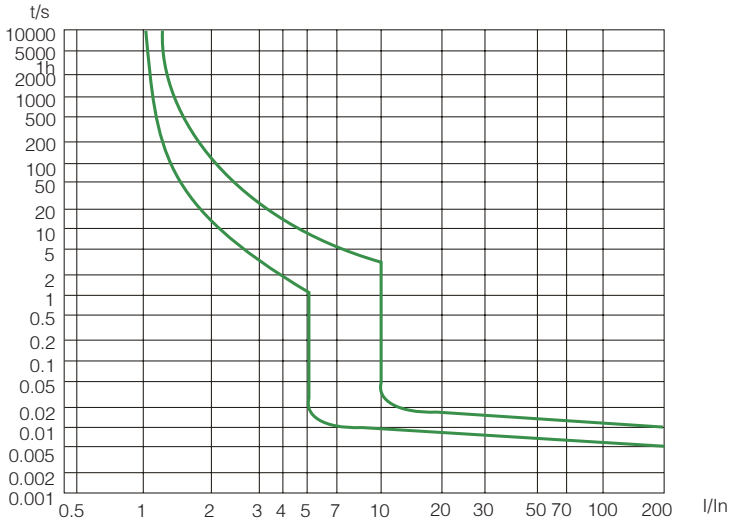

Characteristic D

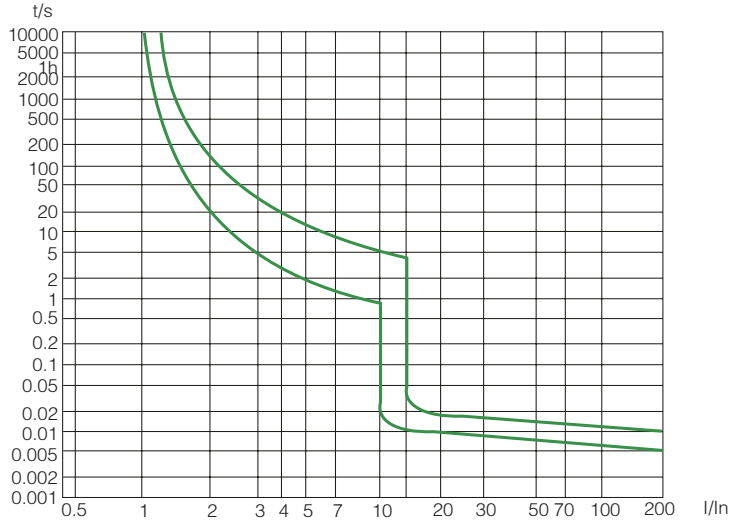

Technical Data Ex9BN

Miniature Circuit Breakers, 6 kA

Dependence of Tripping Characteristics on Ambient Temperature

T [°C]	I _n (T) [A]														
	1 A	2 A	3 A	4 A	6 A	8 A	10 A	13 A	16 A	20 A	25 A	32 A	40 A	50 A	63 A
-30	1.3	2.5	3.8	5.1	7.6	10.2	13.6	16.8	20.5	25.3	31.1	40.5	51.0	64.0	82.0
-25	1.2	2.4	3.7	4.9	7.4	9.9	13.4	16.5	20.0	25.0	30.5	39.8	50.0	63.0	80.7
-20	1.2	2.4	3.6	4.8	7.3	9.7	13.1	16.3	19.8	24.5	30.0	39.2	49.2	62.0	79.2
-15	1.2	2.4	3.5	4.8	7.2	9.5	12.8	15.9	19.4	24.0	29.5	38.5	48.4	60.8	77.8
-10	1.2	2.3	3.5	4.7	7.1	9.3	12.5	15.7	19.0	23.7	29.0	37.9	47.5	59.8	76.3
-5	1.2	2.3	3.4	4.7	7.0	9.2	12.3	15.4	18.7	23.2	28.5	37.2	46.7	58.6	74.7
0	1.1	2.2	3.4	4.5	6.8	9.0	12.0	15.0	18.4	22.8	28.0	36.5	45.8	57.4	73.2
5	1.1	2.2	3.3	4.4	6.6	8.9	11.7	14.7	18.0	22.4	27.5	35.8	45.0	56.3	71.6
10	1.1	2.1	3.3	4.3	6.5	8.7	11.4	14.3	17.6	21.9	27.0	35.0	44.0	55.0	70.0
15	1.1	2.1	3.2	4.3	6.4	8.5	11.0	14.0	17.2	21.5	26.5	34.3	43.0	53.8	68.3
20	1.0	2.1	3.2	4.2	6.3	8.3	10.7	13.7	16.8	21.0	26.0	33.6	42.0	52.6	66.6
25	1.0	2.0	3.0	4.1	6.2	8.2	10.4	13.4	16.4	20.5	25.5	32.8	41.0	51.3	64.8
30	1	2	3	4	6	8	10	13	16	20	25	32	40	50	63
35	0.99	2.00	3.00	3.9	5.9	7.9	9.9	12.8	16.0	20.0	25.0	32.0	39.0	49.0	62.0
40	0.97	1.90	2.90	3.9	5.8	7.8	9.7	12.5	15.0	19.0	24.0	31.0	39.0	48.0	61.0
45	0.95	1.90	2.80	3.8	5.7	7.7	9.5	12.2	15.0	19.0	24.0	30.0	38.0	47.0	60.0
50	0.93	1.90	2.80	3.7	5.6	7.6	9.3	12.0	15.0	19.0	23.0	30.0	37.0	46.0	58.0
55	0.91	1.80	2.80	3.6	5.5	7.5	9.0	11.7	14.0	18.0	23.0	29.0	36.0	44.0	57.0
60	0.91	1.80	2.70	3.5	5.4	7.2	8.8	11.5	14.0	18.0	22.0	28.0	35.0	42.0	55.0
65	0.91	1.80	2.70	3.5	5.3	7.1	8.6	11.2	13.0	17.0	21.0	28.0	34.0	40.0	52.0
70	0.91	1.80	2.70	3.5	5.3	6.9	8.6	11.0	13.0	17.0	21.0	27.0	33.0	38.0	50.0

Power loss per pole

I _n [A]	1 A	2 A	3 A	4 A	6 A	8 A	10 A	13 A	16 A	20 A	25 A	32 A	40 A	50 A	63 A
P [W]	1.8	2.1	1.9	2.0	2.5	1.2	1.8	3.1	2.3	2.4	3.5	3.8	4.7	4.7	6.2

Technical Data Ex9B40J

Slim Miniature Circuit Breakers, 6 kA

General parameters

Normal limiting of short circuit current		
Suitable for household as well as commercial applications		
Accessories		
Auxiliary contacts	AX3111, AX3122	100540, 100542
Alarm contact	AL3111	100541
Auxiliary and alarm contact	AXL31	100543
Shunt trip releases	SHT31, SHT3111	100544-100546, 100547-100549
Undervoltage releases	UVT31, UVT3101, UVT3110	100550-100551, 100552-100553, 100554-100555
Oversvoltage release	OVT31 280V AC±5%	100556
Max. number of installed accessories is 3 pcs of one contact units (AX3111, AL3111) or 2 pcs of two contact units (AX3122, AXL31) and 2 pcs of releases (SHT31, UVT31, OVT31)		

Electrical parameters

Tested according to	IEC / EN 60898-1
Rated op. voltage U_e	230/400 V AC
Rated frequency	50 Hz
Rated breaking capacity I_{cn}	6 kA
Rated current	1 — 40 A
Tripping characteristics	B, C
Rated impulse withstand voltage U_{imp}	4 kV
Rated insulation voltage U_i	690 V AC
Mechanical service life	15 000 operation cycles
Electrical service life	10 000 operation cycles
Selectivity class	3
Line voltage connection	arbitrary above or below

Mechanical parameters

Device width	13.5 mm (per pole)
Device height	83 mm (89 mm including rail clip)
Frame size	45 mm
Mounting	easy fastening onto 35 mm device rail (DIN)
Degree of protection	IP20
Terminals	open mouthed
Terminal capacity	1 — 16 mm ²
Fastening torque of terminals	1.5 Nm
Ambient temperature	-25 — +70 °C
Altitude	≤ 2000 m
Relative humidity	≤ 95 %
Resistance to humidity and heat	class 2
Pollution degree	2
Installation class	III
Weight	0.086 kg (per pole)

Technical Data Ex9B40J

Slim Miniature Circuit Breakers, 6 kA

Dimensions

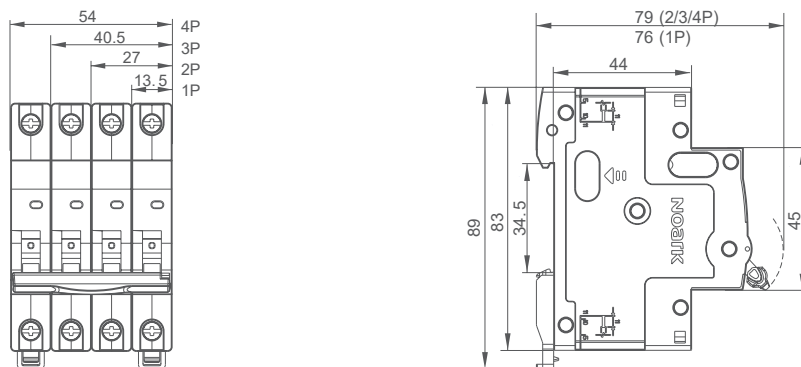

Wiring diagrams

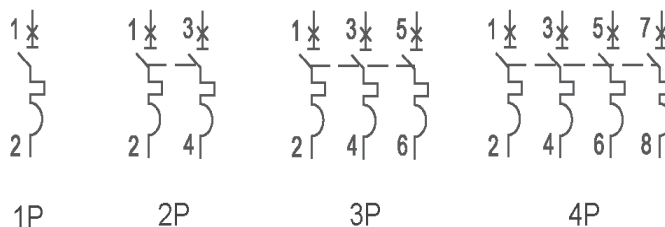

Tripping characteristics

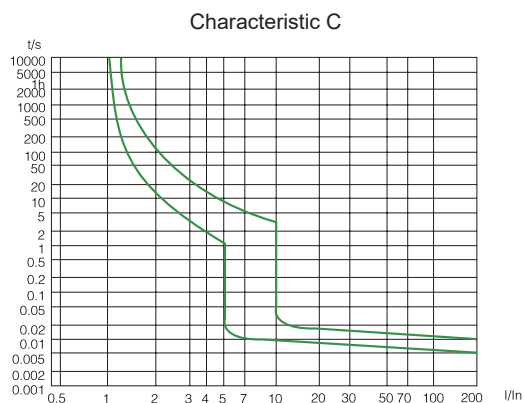
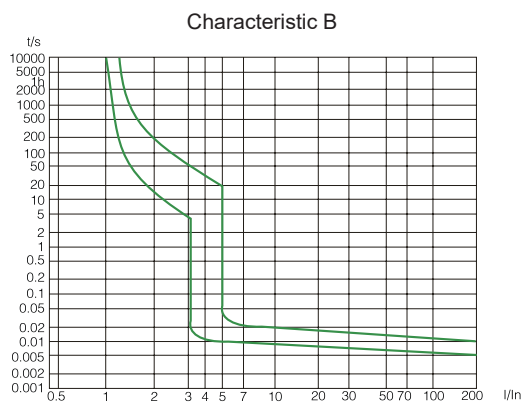

Power loss per pole

I_n [A]	1	2	3	4	6	10	16	20	25	32	40
P [W]	1.9	2.2	1.9	2.2	2.4	1.6	2.2	1.8	2.3	3.3	3.4

Technical Data Ex9B125

Miniature Circuit Breakers up to 100 A

General parameters

Suitable for power distribution and industrial applications

Very high limiting of short circuit current

Accessories (same as for Ex9B MCBs)

Auxiliary contacts	AX3111, AX3122	100540, 100542
Alarm contact	AL3111	100541
Auxiliary and alarm contact	AXL31	100543
Shunt trip releases	SHT31, SHT3111	100544-100546, 100547-100549
Undervoltage releases	UVT31, UVT3101, UVT3110	100550-100551, 100552-100553, 100554-100555
Oversvoltage release	OVT31 280V AC±5%	100556

Max. number of installed accessories is 3 pcs of one contact units (AX3111, AL3111) or 2 pcs of two contact units (AX3122, AXL31) and 2 pcs of releases (SHT31, UVT31, OVT31)

Electrical parameters

Tested according to	EN 60947-2
Rated operating voltage U_e	230/400 V AC 48 V DC
Rated frequency	50/60 Hz
Rated current	16 — 100 A
Poles	1, 1+N, 2, 3, 3+N, 4
Tripping characteristics	B, C, D
Rated ultimate short-circuit breaking capacity I_{cu} (EN 60947-2)	
16, 20, 25, 32, 40, 50, 63 A	25 kA
80, 100 A	20 kA
Rated service short-circuit breaking capacity I_{cs} (EN 60947-2)	
16, 20, 25, 32, 40, 50, 63 A	20 kA
80, 100 A	15 kA
Rated impulse withstand voltage U_{imp}	8 kV
Rated insulation voltage U_i	690 V AC
Electrical service life	10 000 operating cycles
Utilization category	A
Selectivity class	3
Max. back-up fuse	200 A gG
Line voltage connection	arbitrary above or below

Technical Data Ex9B125

Miniature Circuit Breakers up to 100 A

Mechanical parameters

Device width	27 mm (per pole)
Device height	83 mm (89 mm including rail clip)
Frame size	45 mm
Mounting	easy fastening onto 35 mm device rail (DIN)
Degree of protection	IP20
Mechanical service life	20 000 operating cycles
Terminals	open mouthed
Terminal capacity	2.5 — 50 mm ²
Fastening torque of terminals	3.5 — 6 Nm
Ambient temperature	-30 — +70 °C
Altitude	≤ 2000 m
Relative humidity	≤ 95 %
Resistance to humidity and heat	class 2
Pollution degree	2
Installation class	III
Weight	approx 0.2 kg (per pole)

Dimensions

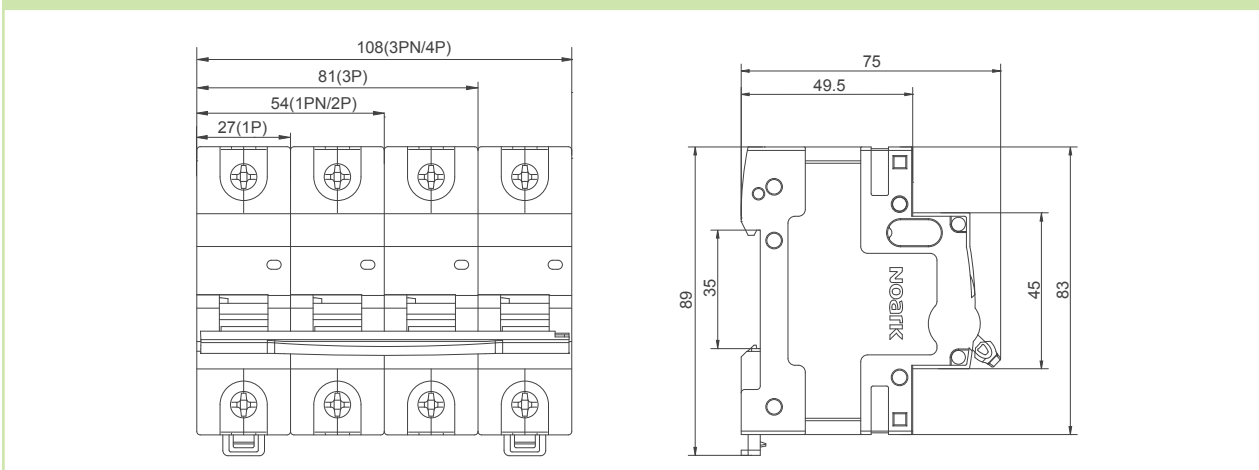

Wiring diagrams

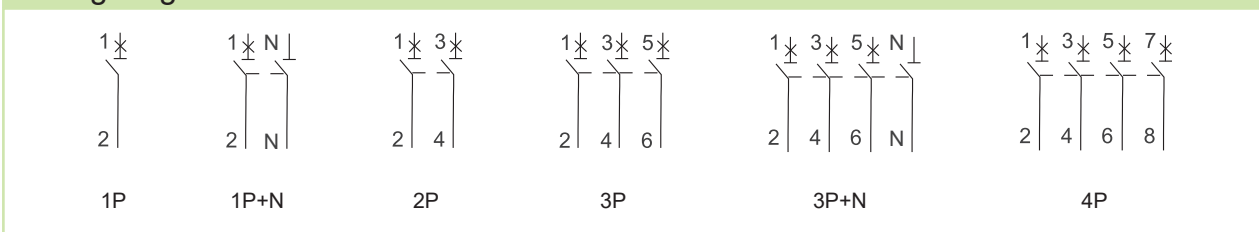

Technical Data Ex9B125

Miniature Circuit Breakers up to 100 A









Dependence of Tripping Characteristics on Ambient Temperature

T [°C]	I _n (T) [A]								
	16 A	20 A	25 A	32 A	40 A	50 A	63 A	80 A	100 A
-30	20.5	25.3	31.1	40.5	51.3	64.2	82.1	105.2	132.6
-20	19.8	24.5	30.2	39.2	49.2	62.4	79.2	103.1	129.8
-10	19.0	23.7	29.6	37.9	47.5	59.8	76.3	99.1	124.0
0	18.4	22.8	28.2	36.5	45.8	57.4	73.2	94.9	118.1
10	17.6	21.9	27.7	35.0	44.3	55.4	70.0	90.3	113.3
20	16.8	21.0	26.1	33.6	42.0	52.6	66.6	86.7	108.2
30	16	20	25	32	40	50	63	80	100
40	15.4	19.3	24.5	31.4	39.2	48.7	61.6	75.8	94.2
50	15.0	18.8	23.2	30.9	37.6	46.2	58.8	71.3	89.6
60	14.2	18.1	22.1	28.6	35.8	42.6	55.4	67.9	85.1
70	13.5	17.7	20.6	27.5	33.1	38.3	50.5	66.3	82.2

Power loss per pole

I _n [A]	16 A	20 A	25 A	32 A	40 A	50 A	63 A	80 A	100 A
P [W]	2.1	2.5	2.9	3.1	3.8	4.4	5.6	6.7	7.7

Toggle colours meaning

I _n	16 A	20 A	25 A	32 A	40 A	50 A	63 A	80 A	100 A
Colour									

Technical Data Ex9B125

Miniature Circuit Breakers up to 100 A

Tripping characteristics

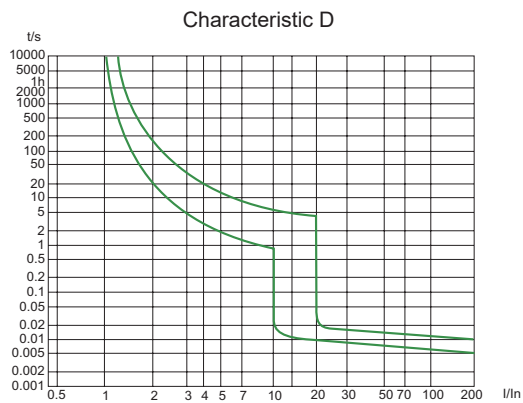
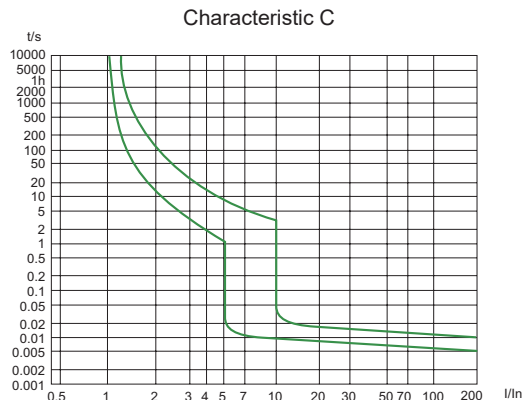
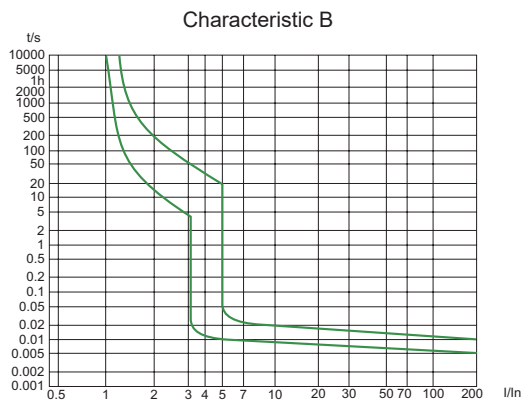

Technical Data Ex9PN

Miniature Circuit Breakers 1P+N in 1MU width

General parameters

Very high limiting of short circuit current

1P+N pole circuit breaker in one module

Suitable for household as well as industrial applications

Accessories

Auxiliary contacts	AX3111, AX3122	100540, 100542
Alarm contact	AL3111	100541
Auxiliary and alarm contact	AXL31	100543
Shunt trip releases	SHT31, SHT3111	100544-100546, 100547-100549
Undervoltage releases	UVT31, UVT3101, UVT3110	100550-100551, 100552-100553, 100554-100555
Oversvoltage release	OVT31 280V AC±5%	100556

Max. number of installed accessories is 3 pcs of one contact units (AX3111, AL3111) or 2 pcs of two contact units (AX3122, AXL31) and 2 pcs of releases (SHT31, UVT31, OVT31)

Electrical parameters

Tested according to	IEC / EN 60898-1
Rated op. voltage U_e	230 V AC
	48 V DC (per pole)
Minimum voltage	12 V AC/DC
Rated frequency	50/60 Hz
Rated breaking capacity I_{cn}	4.5 kA (-S version), 6 kA (-N version)
Rated current	1 — 40 A
Tripping characteristics	B, C
Rated impulse withstand voltage U_{imp}	4 kV
Rated insulation voltage U_i	400 V AC
Mechanical service life	20 000 operation cycles
Electrical service life	10 000 operation cycles
Selectivity class	3
Max. back-up fuse	max. 125 A gG
Line voltage connection	arbitrary above or below

Mechanical parameters

Device width	18 mm
Device height	83 mm (89 mm including rail clip)
Frame size	45 mm
Mounting	easy fastening onto 35 mm device rail (DIN)
Degree of protection	IP20
Terminals	lift
Terminal capacity	1 — 16 mm ²
Ambient temperature	-30 — +70 °C
Altitude	≤ 2000 m
Relative humidity	≤ 95 %
Resistance to humidity and heat	class 2
Pollution degree	2
Installation class	III
Weight	0.12 kg

Technical Data Ex9PN

Miniature Circuit Breakers 1P+N in 1MU width

Dimensions

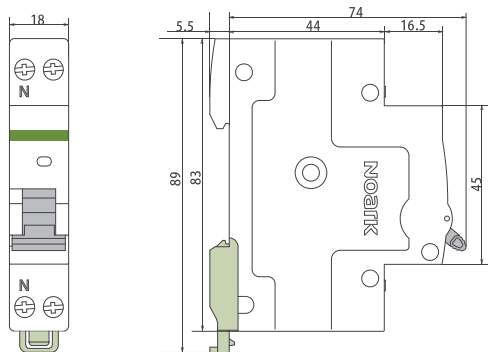

Wiring diagram

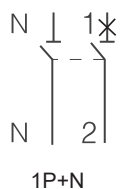

Tripping characteristics

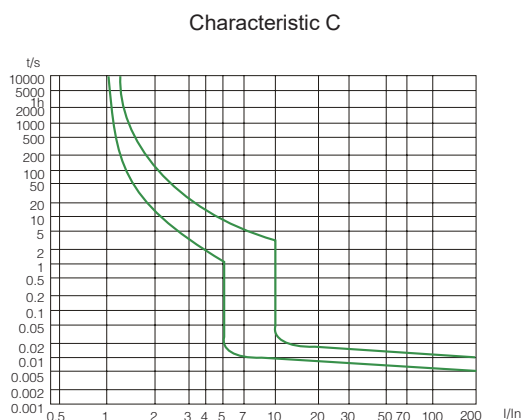
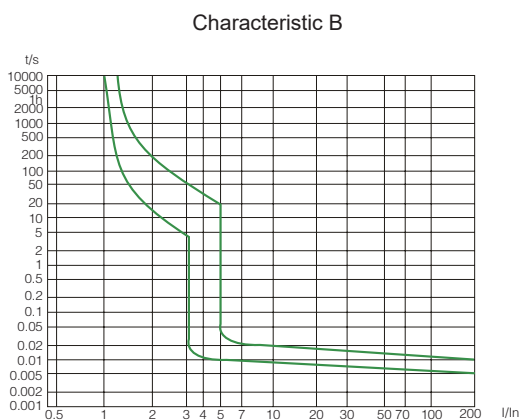

Technical Data Ex9PN

Miniature Circuit Breakers 1P+N in 1MU width

Dependence of Tripping Characteristics on Ambient Temperature

T [°C]	$I_n(T)$ [A]										
	1 A	2 A	3 A	4 A	6 A	10 A	16 A	20 A	25 A	32 A	40 A
-20	1.35	2.6	4.1	5.3	8	13.5	20	24.5	29.8	39.5	50.5
-15	1.28	2.53	4.05	5.15	7.8	13.3	19.8	24.3	29.7	39.3	50.4
-10	1.25	2.4	3.95	5.08	7.6	13	19.5	24	29.5	39	50.2
-5	1.2	2.33	3.9	4.98	7.3	12.7	19.2	23.8	29.3	38.8	50
0	1.18	2.3	3.8	4.8	7.2	12.5	19.1	23.7	29.2	38.6	48.8
5	1.15	2.28	3.6	4.72	7	12.3	18.8	23.5	29	38.4	48.6
10	1.1	2.23	3.45	4.65	6.8	12.1	18.6	23.3	28.8	38.2	48.4
15	1.08	2.18	3.35	4.52	6.6	12	18.5	23.1	28.6	38	48.1
20	1.05	2.09	3.22	4.31	6.4	11.8	18.3	22.8	28.4	37.8	47.8
25	1.05	2.03	3.08	4.22	6.2	11.5	18	22.6	28.2	37.5	47
30	1	2	3	4	6	10	16	20	25	32	40
35	0.99	1.98	2.98	3.95	6	9.9	15.7	19.7	24.6	31.5	39.2
40	0.97	1.95	2.95	3.91	5.9	9.8	15.4	19.3	24.3	31.1	38.8
45	0.95	1.91	2.91	3.85	5.83	9.8	15.1	18.8	24	30.8	38.3
50	0.91	1.88	2.88	3.8	5.72	9.6	14.9	18.5	23.8	30.1	38
55	0.89	1.85	2.82	3.74	5.65	9.5	14.7	18.2	23.5	29.5	36.5
60	0.86	1.81	2.77	3.71	5.5	9	14.5	17.8	23	28.5	35
65	0.84	1.77	2.73	3.65	5.4	8.6	14	17.5	22	27.5	34
70	0.81	1.71	2.65	3.52	5.2	8	13.8	17.3	21.5	27	32.5

Technical Data Ex9BP-JX

General purpose DC Miniature Circuit Breakers Ex9BP-JX

General parameters

For general direct current applications

Polarity dependent - it is necessary to respect the polarity of the current

Accessories

Auxiliary contacts	AX3111, AX3122	100540, 100542
Alarm contact	AL3111	100541
Auxiliary and alarm contact	AXL31	100543
Shunt trip releases	SHT31, SHT3111	100544-100546, 100547-100549
Undervoltage releases	UVT31, UVT3101, UVT3110	100550-100551, 100552-100553, 100554-100555
Max. number of installed accessories is 3 pcs of one contact units (AX3111, AL3111) or 2 pcs of two contact units (AX3122, AXL31) and 2 pcs of releases (SHT31, UVT31)		

Electrical parameters

Tested according to	EN 60947-2
Rated op. voltage U_e	250 (1P), 500 (2P), 750 (3P), 1000 (4P) V DC
Rated ultimate breaking capacity I_{cu}	10 kA
Rated service breaking capacity I_{cs}	100% I_{cu}
Rated current I_n	1 — 63 A
Tripping characteristics	C, K
Rated impulse withstand voltage U_{imp}	4 kV
Rated insulation voltage U_i	1 000 V DC
Mechanical service life	20 000 operation cycles
Electrical service life	2 500 operation cycles
Selectivity class	3
Line voltage connection	necessary to follow marked polarity

Mechanical parameters

Device width	18 mm (per pole/module)
Device height	83 mm (89 mm including rail clip)
Frame size	45 mm
Mounting	easy fastening onto 35 mm device rail (DIN)
Degree of protection	IP20
Terminals	combined lift + open mouthed
Terminal capacity	1 — 35 mm ²
Fastening torque of terminals	2 — 3.5 Nm
Busbar thickness	0.8 — 2 mm
Ambient temperature	-35 — +70 °C
Altitude	≤ 2 000 m
Relative humidity	≤ 95 % at 20°C, ≤ 50 % at 40°C
Resistance to humidity and heat	class 2
Pollution degree	3
Installation class	III
Weight	0.12 kg (per pole/module)

Technical Data Ex9BP-JX

General purpose DC Miniature Circuit Breakers Ex9BP-JX

Dimensions

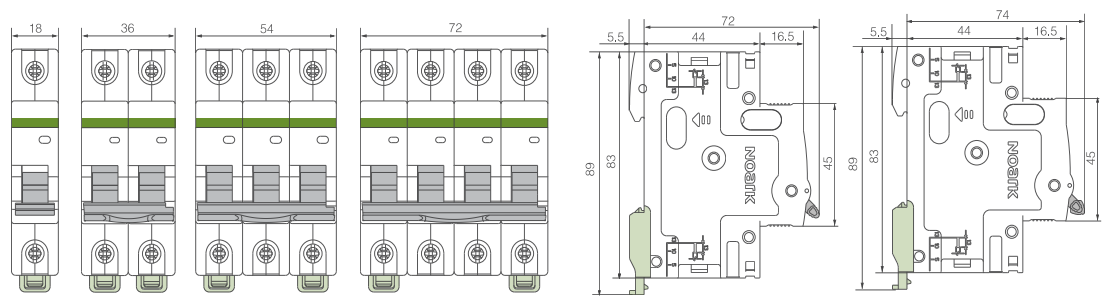

Wiring diagrams

DC 250V

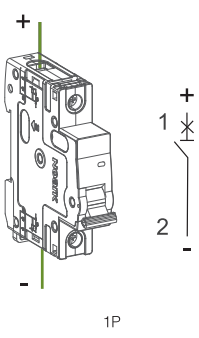

DC 500V

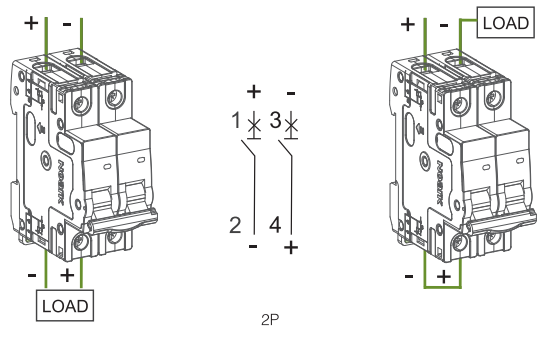

DC 750V

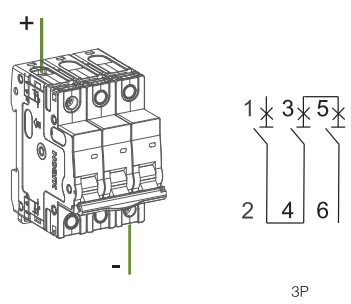

DC 1000V

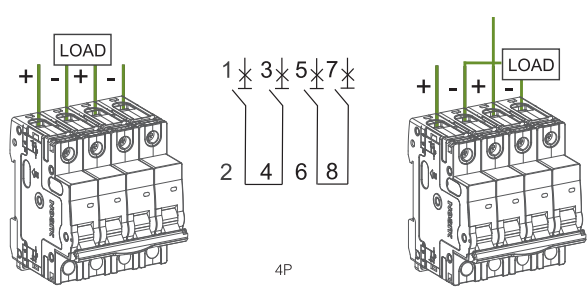

Tripping characteristics

Characteristic C

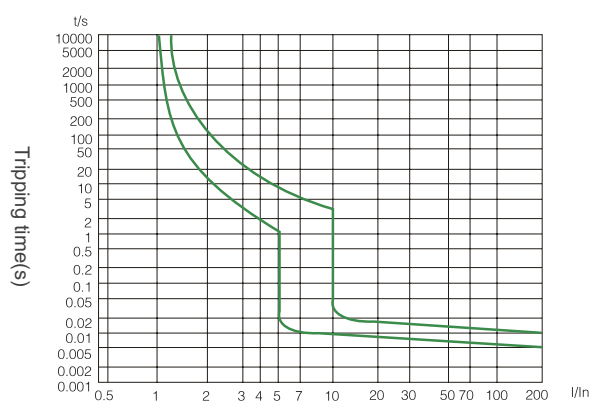

Characteristic K

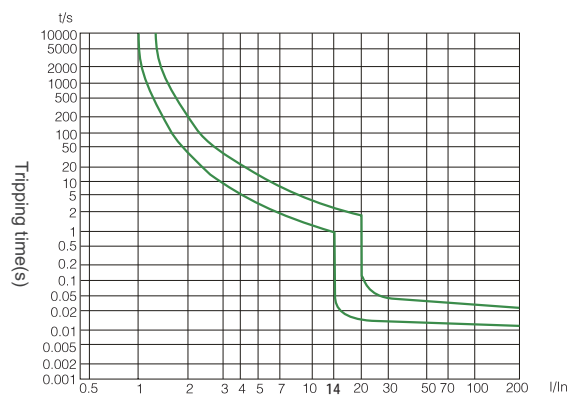

Technical Data Ex9BP-JX

General purpose DC Miniature Circuit Breakers Ex9BP-JX

Dependence of Tripping Characteristics on Ambient Temperature

T [°C]	I _n [A]												
	1 A	2 A	3 A	4 A	6 A	10 A	16 A	20 A	25 A	32 A	40 A	50 A	63 A
-30	1.3	2.5	3.8	5.1	7.6	13.6	20.5	25.3	31.1	40.5	51	64	82
-25	1.2	2.4	3.7	4.9	7.4	13.4	20	25	30.5	39.8	50	63	80.7
-20	1.2	2.4	3.6	4.8	7.3	13.1	19.8	24.5	30	39.2	49.2	62	79.2
-15	1.2	2.4	3.5	4.8	7.2	12.8	19.4	24	29.5	38.5	48.4	60.8	77.8
-10	1.2	2.3	3.5	4.7	7.1	12.5	19	23.7	29	37.9	47.5	59.8	76.3
-5	1.2	2.3	3.4	4.7	7	12.3	18.7	23.2	28.5	37.2	46.7	58.6	74.7
0	1.1	2.2	3.4	4.5	6.8	12	18.4	22.8	28	36.5	45.8	57.4	73.2
5	1.1	2.2	3.3	4.4	6.6	11.7	18	22.4	27.5	35.8	45	56.3	71.6
10	1.1	2.1	3.3	4.3	6.5	11.4	17.6	21.9	27	35	44	55	70
15	1.1	2.1	3.2	4.3	6.4	11	17.2	21.5	26.5	34.3	43	53.8	68.3
20	1	2.1	3.2	4.2	6.3	10.7	16.8	21	26	33.6	42	52.6	66.6
25	1	2	3	4.1	6.2	10.4	16.4	20.5	25.5	32.8	41	51.3	64.8
30	1	2	3	4	6	10	16	20	25	32	40	50	63
35	0.99	2	3	3.9	5.9	9.9	16	20	25	32	39	49	62
40	0.97	1.9	2.9	3.9	5.8	9.7	15	19	24	31	39	48	61
45	0.95	1.9	2.8	3.8	5.7	9.5	15	19	24	30	38	47	60
50	0.93	1.9	2.8	3.7	5.6	9.3	15	19	23	30	37	46	58
55	0.91	1.8	2.8	3.6	5.5	9	14	18	23	29	36	44	57
60	0.91	1.8	2.7	3.5	5.4	8.8	14	18	22	28	35	42	55
65	0.91	1.8	2.7	3.5	5.3	8.6	13	17	21	28	34	40	52
70	0.91	1.8	2.7	3.5	5.3	8.6	13	17	21	27	33	38	50

Power loss per pole

I _n [A]	1 A	2 A	3 A	4 A	6 A	10 A	16 A	20 A	25 A	32 A	40 A	50 A	63 A
P [W]	1.5	2.0	1.8	2.0	2.2	1.5	1.8	2.0	2.2	2.6	2.9	3.8	4.4

Technical Data Ex9F

Cylindrical Fuse Holders

General parameters

Versions for fuse-link size 10x38, 14x51 and 22x58 mm, suitable for gG and aM type fuse-links
Utilization category AC-20B at 400/690 V AC
Status signalization on Ex9F only
To be operated by qualified persons only

Electrical parameters

	Ex9F	Ex9F-14	Ex9F-22
Tested according to	EN 60947-3		
Rated operating voltage U_e	400/690 V AC		
Rated frequency f	50 Hz		
Rated conventional thermal current I_{th}	32 A	50 A	100 A
Rated operating current I_e	32 A	50 A	100 A
Number of poles	1P, 1P+N, 2P, 3P, 3P+N		
Suitable fuse-link size	10 x 38 mm	14 x 51 mm	22 x 58 mm
Fuse-link rated current at 400/690 V AC gG/aM at 690 V AC	32 A 32 A	50 A 50 A	100 A 100 A
Rated cond. short-circuit strength I_q at 400 V AC at 690 V AC	120 kA 80 kA	120 kA 80 kA	120 kA 80 kA
Rated insulation voltage U_i	1000 V		
Rated impulse withstand voltage U_{imp}	6 kV	8 kV	8 kV
Utilization category at 400/690 V AC	AC-20B		
Electrical service life	300 operational cycles		
Power loss without fuse-link	1.6 W		
Max. power loss of installed fuse-link gG aM	3 W 3 W	5 W 3 W	9.5 W 7 W

Mechanical parameters

Device width per pole	18 mm	27 mm	36 mm
Device height	83 mm	93 mm	107 mm
Frame size	45 mm		
Mounting	onto DIN rail 35 mm		
Degree of protection	IP20		
Terminal capacity	1 – 25 mm ²	1 – 25 mm ²	1 – 35 mm ²
Fastening torque of terminals	2.5 Nm	3.5 Nm	3.5 Nm
Ambient temperature	-30 – +70°C		
Altitude	≤ 2000 m		
Relative humidity	+20°C ≤ 35 %	+40°C ≤ 50 %	+40°C ≤ 50 %
Resistance to humidity and heat	50 %		
Pollution degree	3		
Installation class	III		
Overvoltage category	I / 690 V AC	II / 500 V AC	III / 400 V AC
Mechanical service life	2000 operational cycles		
Weight (per pole without fuse-link)	0.07 kg	0.10 kg	0.17 kg

Technical Data Ex9F

Cylindrical Fuse Holders

Dimensions

Ex9F

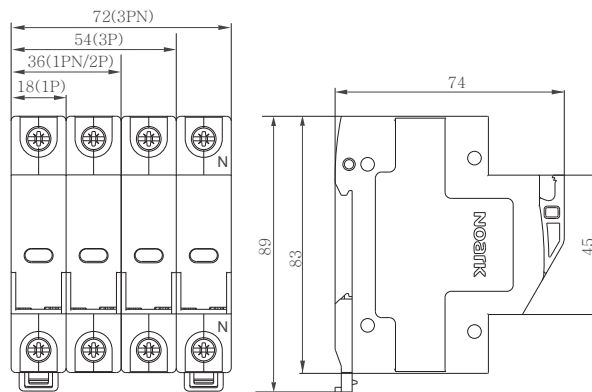

Ex9F-14

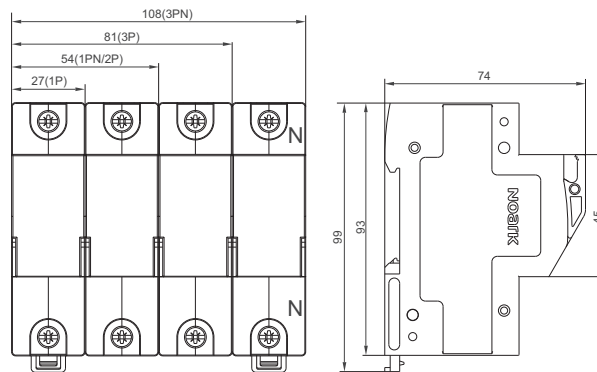

Ex9F-22

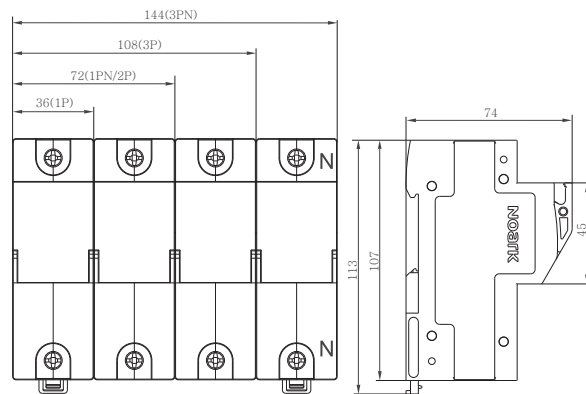

Wiring diagrams

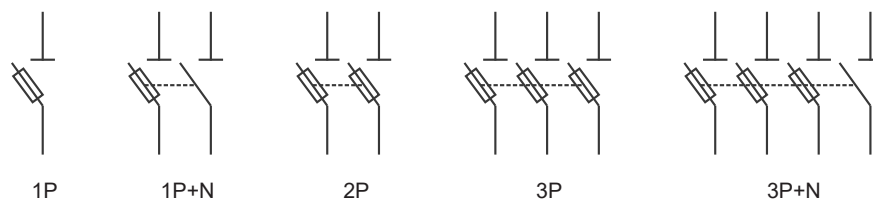

Technical Data Ex9FP

DC fuse disconnectors

General parameters

For protecting against overload and short-circuit current in direct current and PV applications
Modular design, width 1 MU per pole
Fuse fault indicator
Fuse disconnector cannot be operated by unskilled person (EN 60947-3)

Electrical parameters

Tested according to	IEC / EN 60947-3
Rated operating voltage U_e	1000 V DC
Rated current I_e DC-20B 1000 V DC	up to 30 A
Number of poles	1, 2
Rated insulation voltage U_i	1000 V DC
Rated impulse withstand voltage U_{imp}	6 kV
Utilization category	DC-20B
Rated short-time breaking capacity	33 kA (30 kA from 20A)
Rated conditional short-circuit current	20 kA
Maximum power loss of fuse link	4 W

Mechanical parameters

Device width	18 mm (per pole)
Device height	83 mm (89 mm including rail clip)
Frame size	45 mm
Mounting	easy fastening onto 35 mm device rail (DIN)
Degree of protection	IP20
Terminal capacity	2.5 — 10 mm ²
Ambient temperature	-30 — +70 °C
Altitude	≤ 2000 m
Relative humidity	≤ 95 %
Resistance to humidity and heat	class 2
Pollution degree	3
Installation class	III
Fuse dimension	10 x 38 mm
Weight	0.07 kg per pole

Technical Data Ex9FP

DC fuse disconnectors

Dimensions

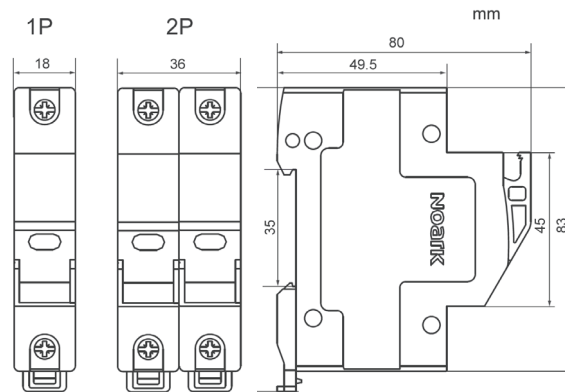

Wiring diagrams

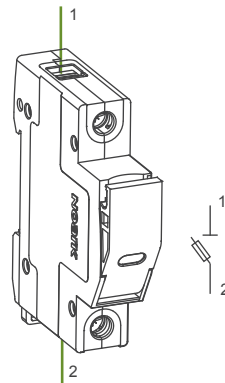

Technical Data Ex9FS

Cylindrical Fuse Switch Disconnectors

General parameters

Versions for fuse-link size 10x38, 14x51 and 22x58 mm, suitable for gG and aM type fuse-links
Utilization categories AC-21B at 500 V AC and AC-22B at 400 V AC
Status signalization on Ex9FS only
To be operated by qualified persons only

Electrical parameters

	Ex9FS	Ex9FS-14	Ex9FS-22
Tested according to	EN 60947-3		
Rated operating voltage U_e	400/500 V AC		
Rated frequency f	50/60 Hz		
Rated conventional thermal current I_{th}	32 A	50 A	100 A
Rated operating current I_e	32 A	50 A	100 A
Number of poles	1P, 1P+N, 2P, 3P, 3P+N		
Suitable fuse-link size	10 x 38 mm	14 x 51 mm	22 x 58 mm
Fuse-link rated current at 400 V AC at 500 V AC	32 A 32 A	50 A 50 A	100 A 100 A
Rated cond. short-circuit strength I_q at 400 V AC at 500 V AC	120 kA 100 kA	120 kA 100 kA	120 kA 100 kA
Rated insulation voltage U_i	1000 V		
Rated impulse withstand voltage U_{imp}	6 kV	8 kV	8 kV
Utilization categories at 400 V AC at 500 V AC	AC-22B AC-21B		
Electrical service life	300 operational cycles		
Power loss without fuse-link	1.6 W		
Max. power loss of installed fuse-link gG aM	3 W at 32 A 3 W at 25 A	5 W at 50 A 3 W at 40 A	9.5 W at 100 A 7 W at 80 A

Mechanical parameters

	Ex9FS	Ex9FS-14	Ex9FS-22
Device width per pole	18 mm	27 mm	36 mm
Device height	83 mm	93 mm	107 mm
Frame size	45 mm		
Mounting	onto DIN rail 35 mm		
Degree of protection	IP20		
Terminal capacity	1 – 16 mm ²	1 – 25 mm ²	1 – 35 mm ²
Fastening torque of terminals	2.5 Nm	3.5 Nm	3.5 Nm
Ambient temperature	-30 – +70°C		
Altitude	≤ 2000 m		
Relative humidity	+20°C ≤ 35 %	+40°C ≤ 50 %	+40°C ≤ 50 %
Resistance to humidity and heat	50 %		
Pollution degree	3		
Installation class	III		
Overvoltage category	I / 500 V AC	II / 500 V AC	III / 400 V AC
Mechanical service life	2000 operational cycles		
Weight (per pole without fuse-link)	0.07 kg	0.10 kg	0.17 kg

Technical Data Ex9FS

Cylindrical Fuse Switch Disconnectors

Dimensions

Ex9FS

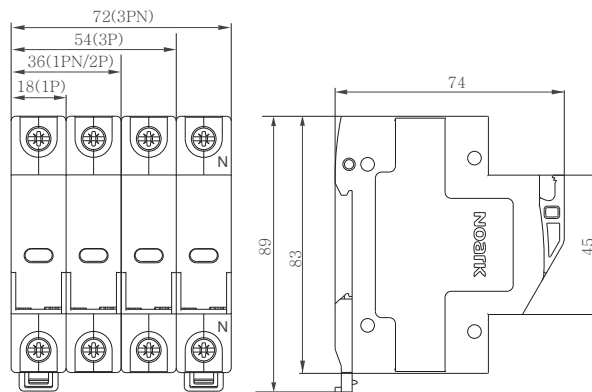

Ex9FS-14

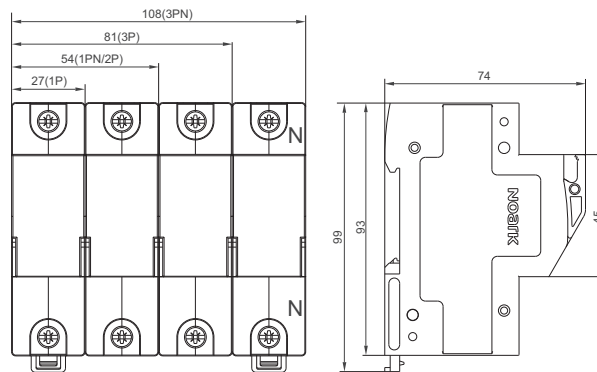

Ex9FS-22

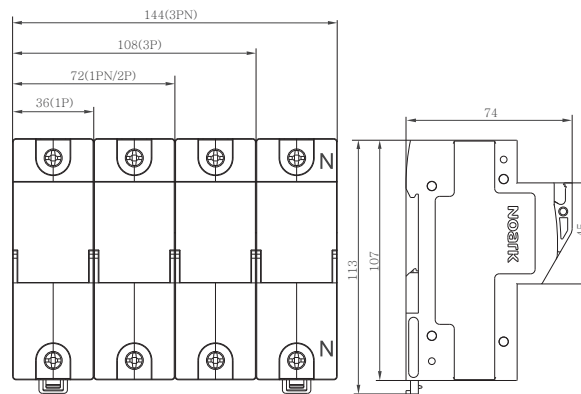

Wiring diagrams

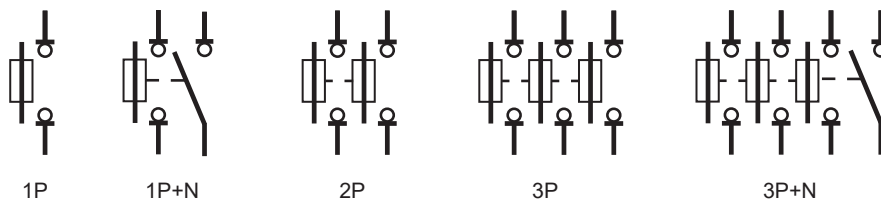

Technical Data Ex9I125

Isolators up to 125 A

General parameters

Modular design
Main switches with isolation function
Built-in lock mechanism for OFF position

Electrical parameters

Tested according to	IEC / EN 60947-3
Rated op. voltage	230/400 V AC
Rated frequency	50/60 Hz
Rated current I_e AC-22A 230/400 V AC	16, 25, 32, 40, 63, 80, 100, 125 A
Number of poles	1, 2, 3, 4
Utilization category	AC-22A
Rated insulation voltage U_i	500 V
Rated impulse withstand voltage U_{imp}	6 kV
Rated short-time withstand current I_{cw} , 1 s	$12 \times I_e$
Rated short-circuit making capacity I_{cm} $I_n = 16, 25, 32$ A $I_n = 40, 63$ A $I_n = 80, 100, 125$ A	640 A 1 260 A 2 500 A
Maximum back-up fuse	160 A gG
Mechanical service life	20 000 operation cycles
Electrical service life	4 000 operation cycles

Mechanical parameters

Device width	18 mm (per pole)
Device height	83 mm (89 mm including rail clip)
Frame size	45 mm
Mounting	easy fastening onto 35 mm device rail (DIN)
Degree of protection	IP40, terminals IP20
Terminals	combined lift + open mouthed
Terminal capacity	10 — 50 mm ²
Fastening torque of terminals	2 — 3.5 Nm
Busbar thickness	0.8 — 2 mm
Ambient temperature	-30 — +70 °C
Altitude	≤ 2000 m
Relative humidity	≤ 95 %
Resistance to humidity and heat	class 2
Pollution degree	2
Installation class	III
Weight	0.09 kg per pole

Technical Data Ex9I125

Isolators up to 125 A

Dimensions

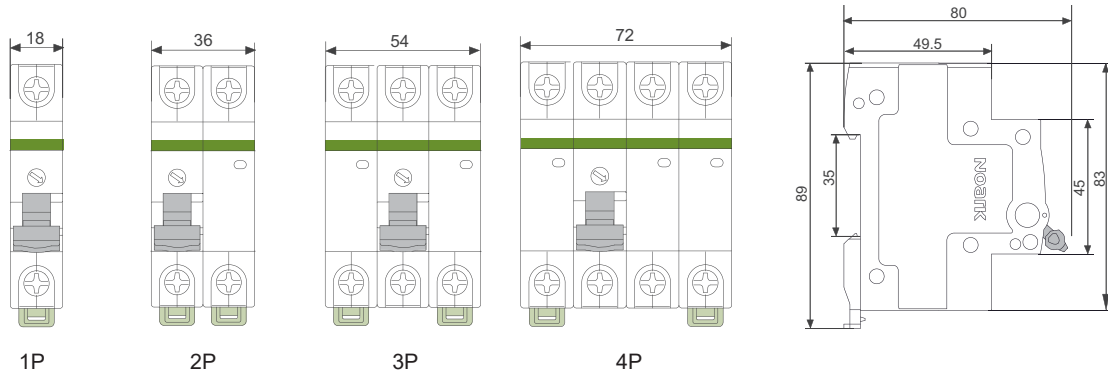

Wiring diagrams

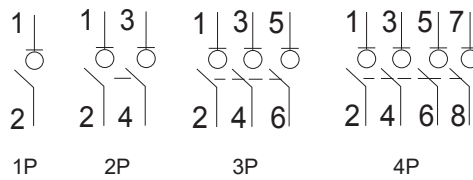

Technical Data Ex9I40

Isolators up to 40 A

General parameters

Modular design, width 1 MU only up to 4-pole version
Main switches with isolation function
Built-in lock mechanism for OFF position

Electrical parameters

Tested according to	IEC / EN 60947-3
Rated op. voltage	230/400 V AC
Rated frequency	50/60 Hz
Rated current I_e AC-22A 230/400 V AC	16, 25, 32, 40 A
Number of poles	1, 2, 3, 4
Utilization category	AC-22A
Rated insulation voltage U_i	500 V
Rated impulse withstand voltage U_{imp}	6 kV
Rated short-time withstand current I_{cw} , 1 s	$12 \times I_e$
Rated short-circuit making capacity I_{cm}	$20 \times I_e$ (0.1 s)
Maximum back-up fuse	50 A gG
Mechanical service life	20 000 operation cycles
Electrical service life	4 000 operation cycles

Mechanical parameters

Device width	18 mm for all versions
Device height	83 mm (89 mm including rail clip)
Frame size	45 mm
Mounting	easy fastening onto 35 mm device rail (DIN)
Degree of protection	IP40, terminals IP20
Terminals	lift
Terminal capacity	1 — 10 mm ²
Fastening torque of terminals	1 — 1.5 Nm
Ambient temperature	-30 — +70 °C
Altitude	≤ 2000 m
Relative humidity	≤ 95 %
Resistance to humidity and heat	class 2
Pollution degree	2
Installation class	III
Weight	0.06 kg

Technical Data Ex9I40

Isolators up to 40 A

Dimensions

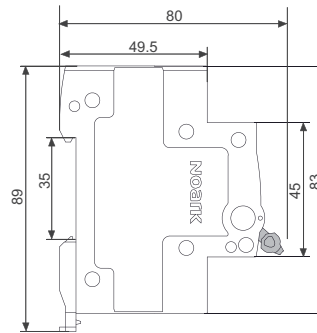

Wiring diagrams

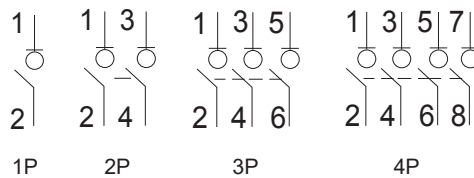

Technical Data Ex9BI

Isolators up to 63 A with Accessories

General parameters

Modular Isolators

Usable as main switches with isolation function

Suitable for household as well as industrial applications

Accessories

Auxiliary contacts	AX3111, AX3122	100540, 100542
Shunt trip releases	SHT31, SHT3111	100544-100546, 100547-100549
Undervoltage releases	UVT31, UVT3101, UVT3110	100550-100551, 100552-100553, 100554-100555
Oversvoltage release	OVT31 280V AC±5%	100556

Max. number of installed accessories is 3 pcs of one contact units (AX3111) or 2 pcs of two contact units (AX3122) and 2 pcs of releases (SHT31, UVT31, OVT31)

Electrical parameters

Tested according to	IEC / EN 60947-3
Rated op. voltage	230/400 V AC
Rated frequency	50 Hz
Rated current I_e AC-22A 230/400 V AC	16, 25, 32, 40, 63 A
Number of poles	1, 2, 3, 4
Utilization category	AC-22A
Rated insulation voltage U_i	690 V
Rated impulse withstand voltage U_{imp}	6 kV
Rated short-time withstand current I_{cw} , 1 s	1 kA
Rated short-circuit making capacity I_{cm}	1.5 kA
Maximum back-up fuse	125 A gG
Mechanical service life	20 000 operation cycles
Electrical service life	10 000 operation cycles

Mechanical parameters

Device width	18 mm (per pole)
Device height	83 mm (89 mm including rail clip)
Frame size	45 mm
Mounting	easy fastening onto 35 mm device rail (DIN)
Degree of protection	IP20
Terminals	combined lift + open mouthed
Terminal capacity	10 — 50 mm ²
Fastening torque of terminals	2 — 3,5 Nm
Busbar thickness	0,8 — 2 mm
Ambient temperature	-30 — +70 °C
Altitude	≤ 2000 m
Relative humidity	≤ 95 %
Resistance to humidity and heat	class 2
Pollution degree	2
Installation class	III
Weight	0.09 kg per pole

Technical Data Ex9BI

Isolators up to 63 A with Accessories

Dimensions

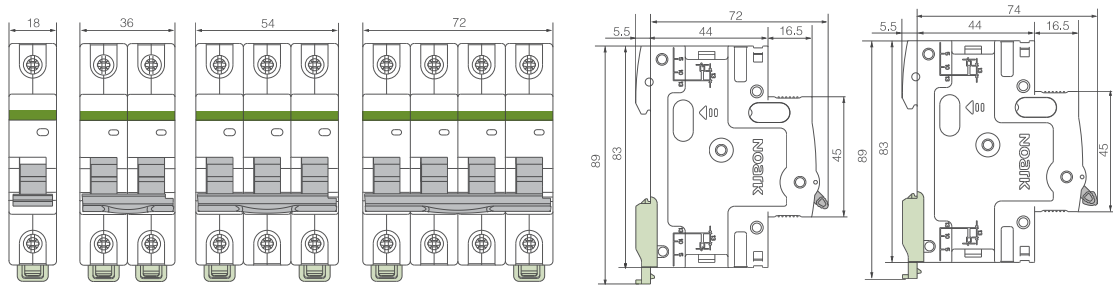

Wiring diagrams

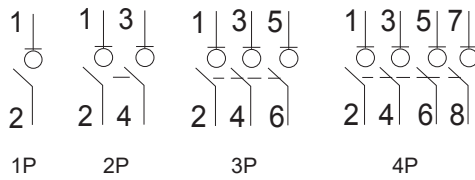

Technical Data Ex9L-H

Residual Current Circuit Breakers, 10 kA

General parameters

Permanent magnet principle - voltage independent tripping function
Suitable for household as well as industrial applications
AC, A, S and G types
Magnetic RCCBs should be tested regularly with a period of one month. This is a responsibility of the user of an installation given by law
In case all wires are not connected at 4-pole RCCB, it is necessary to ensure that circuit of the test button T is supplied with appropriate voltage (by means of mutual connection of respective terminals of the RCCB, see wiring diagram)
Indication of electrical tripping

Electrical parameters

Tested according to	EN 61008
Rated operational voltage U_e	230/400 V AC
Min. voltage for RCD function	voltage independent
Voltage range of the test button T	150 — 254 V AC (2-pole) 150 — 440 V AC (4-pole)
Rated frequency f	50/60 Hz
Conditional short circuit strength I_{nc}	10 kA
Rated current I_n	16, 25, 40, 63 A
Rated residual current $I_{\Delta n}$	10, 30, 100, 300, 500 mA
Sensitivity to residual current	AC type - AC residual current A type - residual AC and pulsating DC current
Time characteristic	AC, A - undelayed type G - delay (insensitivity) 10 - 300 ms S - delay (insensitivity) 130 - 500 ms
Rated impulse withstand voltage U_{imp}	6 kV
Rated insulation voltage U_i	500 V
Surge current proof	3000 A
Mechanical service life	20 000 operation cycles
Electrical service life	4 000 operation cycles
Back-up fuse for overload	
$I_n = 16$ A	max. 25 A gG
$I_n = 25$ A	max. 25 A gG
$I_n = 40$ A	max. 32 A gG
$I_n = 63$ A	max. 50 A gG
Back-up fuse for short circuit	
$I_n = 16$ A	max. 63 A gG
$I_n = 25$ A	max. 63 A gG
$I_n = 40$ A	max. 63 A gG
$I_n = 63$ A	max. 63 A gG
Rated making capacity I_m (rated residual making capacity $I_{\Delta m}$)	
$I_n = 16$ A	500 A
$I_n = 25$ A	500 A
$I_n = 40$ A	500 A
$I_n = 63$ A	630 A
Line voltage connection	arbitrary above or below

Technical Data Ex9L-H

Residual Current Circuit Breakers, 10 kA

Mechanical parameters

Device width	36 mm (2-pole), 72 mm (4-pole)
Device height	85 mm including rail clip
Frame size	45 mm
Mounting	easy fastening onto 35 mm device rail (DIN)
Degree of protection	IP20
Terminals	combined lift + open mouthed
Terminal capacity	1 — 25 mm ²
Fastening torque of terminals	1.5 — 2.5 Nm
Busbar thickness	0.8 — 2 mm
Ambient temperature	-25 — +60 °C
Altitude	≤ 2000 m
Relative humidity	≤ 95 %
Resistance to humidity and heat	class 2
Pollution degree	2
Installation class	III
Weight	0.22 kg (2-pole), 0.4 kg (4-pole)

Dimensions

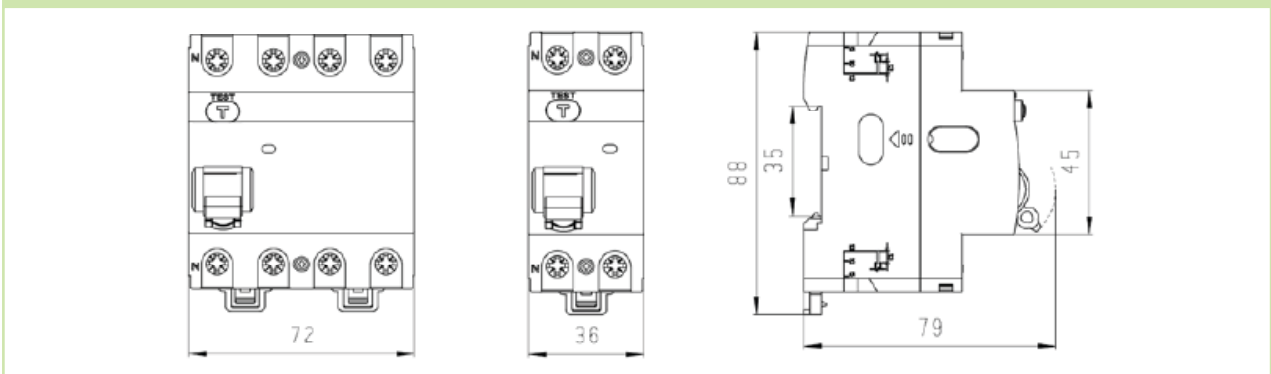

Wiring diagrams

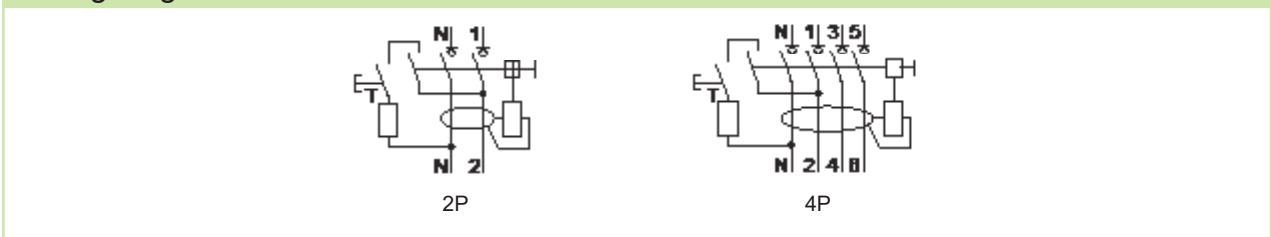

Technical Data Ex9L-H

Residual Current Circuit Breakers, 10 kA

Tripping characteristics

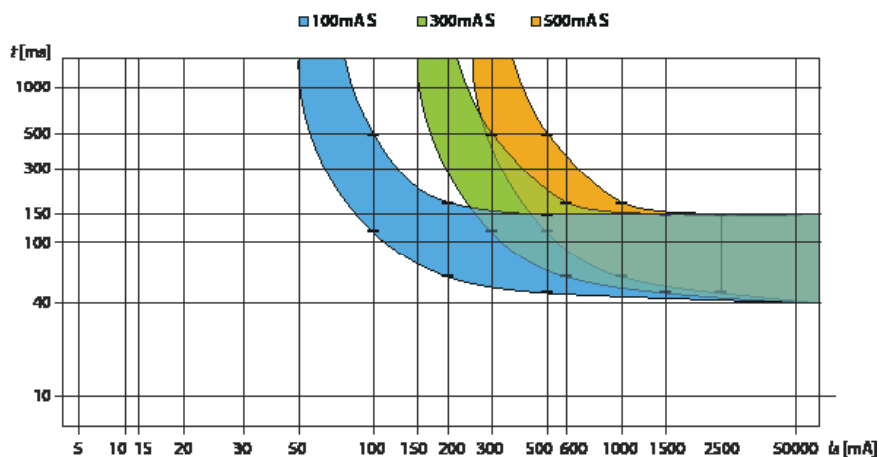
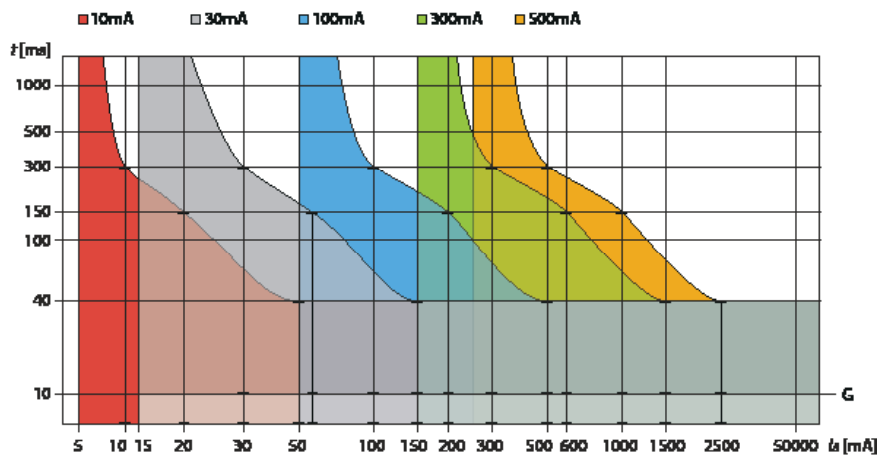

Power loss

I_n	I_{Δ}	2P	4P
16 A	10 mA	1.8 W	3.8 W
	30 mA	1.8 W	3.8 W
	100 mA	1.8 W	3.8 W
	300 mA	1.8 W	3.8 W
	500 mA	1.8 W	3.8 W
25 A	10 mA	3.4 W	7.2 W
	30 mA	3.4 W	7.2 W
	100 mA	3.4 W	7.2 W
	300 mA	3.4 W	7.2 W
	500 mA	3.4 W	7.2 W
40 A	30 mA	7.2 W	15.3 W
	100 mA	7.2 W	15.3 W
	300 mA	7.2 W	15.3 W
	500 mA	7.2 W	15.3 W
63 A	30 mA	15 W	24 W
	100 mA	15 W	24 W
	300 mA	15 W	24 W
	500 mA	15 W	24 W

Technical Data Ex9L-N

Residual Current Circuit Breakers, 6 kA

General parameters

Permanent magnet principle - Voltage independent tripping function
Suitable for household as well as industrial applications
AC, A, S and G type
Magnetic RCCBs should be tested regularly with a period of one month. This is a responsibility of the user of an installation given by law
In case all wires are not connected at 4-pole RCCB, it is necessary to ensure that circuit of the test button T is supplied with appropriate voltage (by means of mutual connection of respective terminals of the RCCB, see wiring diagram)
Indication of electrical tripping

Electrical parameters

Tested according to	EN 61008
Rated op. voltage U_e	240/415 V AC
Min. voltage for RCD function	voltage independent
Voltage range of the test button T	150 — 254 V AC (2-pole), 150 — 440 V AC (4-pole)
Rated frequency f	50/60 Hz
Conditional short circuit strength I_{nc}	6 kA
Rated current I_n	16, 25, 40, 63 A
Rated residual current $I_{\Delta n}$	10, 30, 100, 300, 500 mA
Sensitivity to residual current	AC type - AC residual current A type - residual AC and pulsating DC current
Time characteristic	AC, A - undelayed type G - delay (insensitivity) 10 - 300 ms S - delay (insensitivity) 130 - 500 ms
Rated impulse withstand voltage U_{imp}	6 kV
Rated insulation voltage U_i	500 V
Surge current proof	3000 A
Mechanical service life	20 000 operation cycles
Electrical service life	4 000 operation cycles
Back-up fuse for overload	
$I_n = 16$ A	max. 25 A gG
$I_n = 25$ A	max. 25 A gG
$I_n = 40$ A	max. 32 A gG
$I_n = 63$ A	max. 50 A gG
Back-up fuse for short circuit	
$I_n = 16$ A	max. 63 A gG
$I_n = 25$ A	max. 63 A gG
$I_n = 40$ A	max. 63 A gG
$I_n = 63$ A	max. 63 A gG
Rated making capacity I_m (rated residual making capacity $I_{\Delta m}$)	
$I_n = 16$ A	500 A
$I_n = 25$ A	500 A
$I_n = 40$ A	500 A
$I_n = 63$ A	630 A
Line voltage connection	arbitrary above or below

Technical Data Ex9L-N

Residual Current Circuit Breakers, 6 kA

Mechanical parameters

Device width	36 mm (2-pole), 72 mm (4-pole)
Device height	85 mm including rail clip
Frame size	45 mm
Mounting	easy fastening onto 35 mm device rail (DIN)
Degree of protection	IP20
Terminals	combined lift + open mouthed
Terminal capacity	1 — 25 mm ²
Fastening torque of terminals	1.5 — 2.5 Nm
Busbar thickness	0.8 — 2 mm
Ambient temperature	-25 — +60 °C
Altitude	≤ 2000 m
Relative humidity	≤ 95 %
Resistance to humidity and heat	class 2
Pollution degree	2
Installation class	III
Weight	0.22 kg (2-pole), 0.4 kg (4-pole)

Dimensions

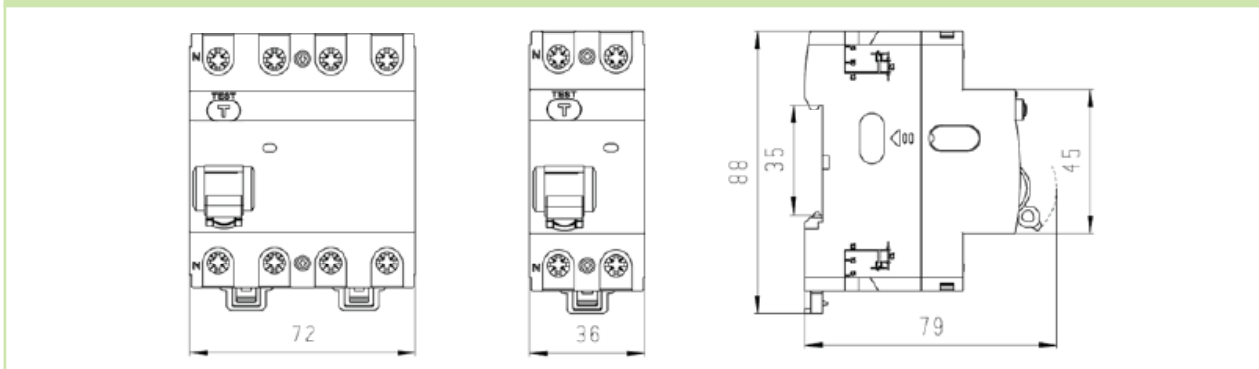

Wiring diagrams

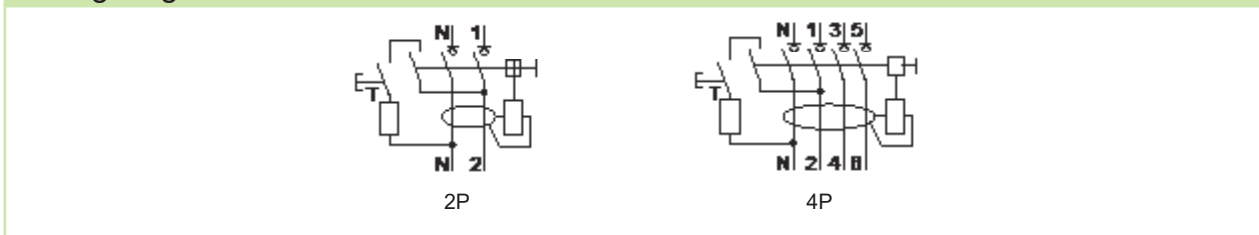

Technical Data Ex9L-N

Residual Current Circuit Breakers, 6 kA

Tripping characteristics

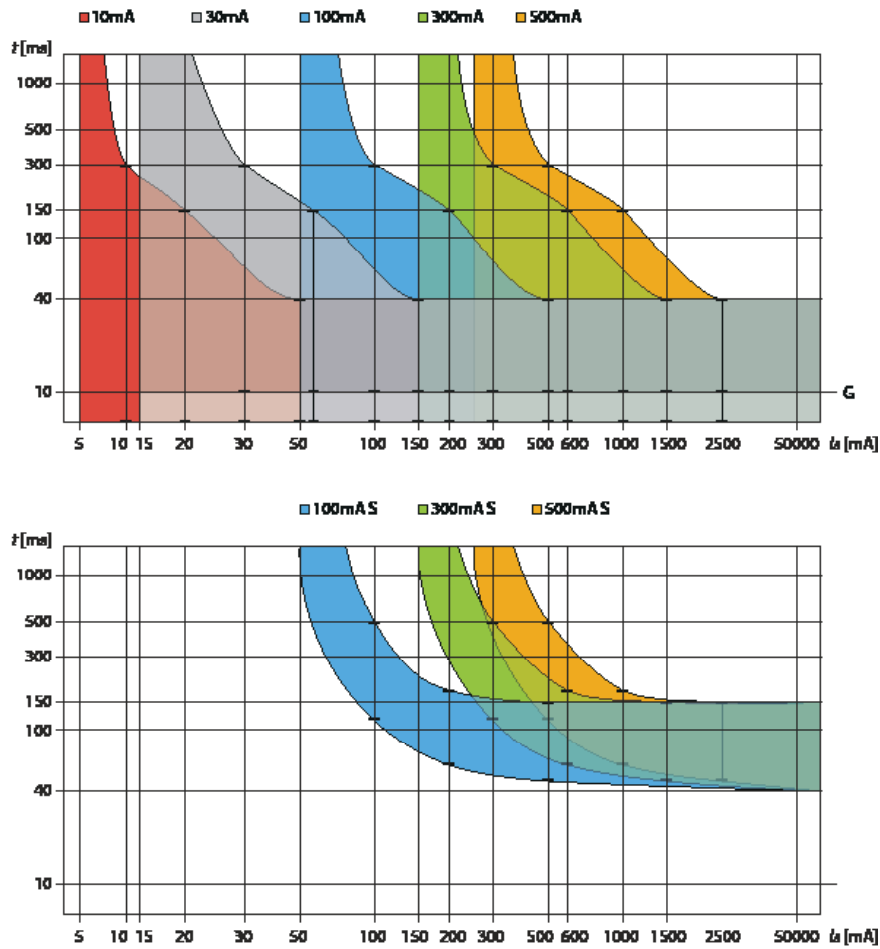

Power loss

I_n	I_{Δ}	2P	4P
16 A	10 mA	1.8 W	3.8 W
	30 mA	1.8 W	3.8 W
	100 mA	1.8 W	3.8 W
	300 mA	1.8 W	3.8 W
	500 mA	1.8 W	3.8 W
25 A	10 mA	3.4 W	7.2 W
	30 mA	3.4 W	7.2 W
	100 mA	3.4 W	7.2 W
	300 mA	3.4 W	7.2 W
	500 mA	3.4 W	7.2 W
40 A	30 mA	7.2 W	15.3 W
	100 mA	7.2 W	15.3 W
	300 mA	7.2 W	15.3 W
	500 mA	7.2 W	15.3 W
63 A	30 mA	15 W	24 W
	100 mA	15 W	24 W
	300 mA	15 W	24 W
	500 mA	15 W	24 W

Technical Data Ex9CL-100

Residual Current Circuit Breakers up to 100 A, 10 kA

General parameters

Permanent magnet principle - Voltage independent tripping function
Suitable for household as well as industrial applications
S and S+A types
Magnetic RCCBs should be tested regularly with a period of one month. This is a responsibility of the user of an installation given by law
In case all wires are not connected at 4-pole RCCB, it is necessary to ensure that circuit of the test button T is supplied with appropriate voltage (by means of mutual connection of respective terminals of the RCCB, see wiring diagram)
Indication of electrical tripping

Electrical parameters

Tested according to	IEC/EN 61008
Rated op. voltage U_e	230/400 V AC
Min. voltage for RCD function	voltage independent
Voltage range of the test button T	150 — 254 V AC (2-pole), 150 — 440 V AC (4-pole)
Rated frequency	50/60 Hz
Conditional short circuit strength I_{nc}	10 kA
Rated current	63, 80, 100 A
Rated residual current	100, 300 mA
Sensitivity to residual current	AC type - AC residual current A type - residual AC and pulsating DC current
Time characteristic	selective S type with insensitivity 40 ms
Rated impulse withstand voltage U_{imp}	6 kV
Rated insulation voltage U_i	500 V
Surge current proof	3000 A
Mechanical service life	20 000 operation cycles
Electrical service life	4 000 operation cycles
Back-up fuse for overload	
$I_n = 63$ A	max. 50 A gG
$I_n = 80$ A	max. 63 A gG
$I_n = 100$ A	max. 80 A gG
Back-up fuse for short circuit	
$I_n = 63$ A	max. 63 A gG
$I_n = 80$ A	max. 80 A gG
$I_n = 100$ A	max. 100 A gG
Rated making capacity I_m (rated residual making capacity $I_{\Delta m}$)	
$I_n = 63$ A	630 A
$I_n = 80$ A	1000 A
$I_n = 100$ A	1000 A
Line voltage connection	arbitrary above or below

Technical Data Ex9CL-100

Residual Current Circuit Breakers up to 100 A, 10 kA

Mechanical parameters

Device width	36 mm (2-pole), 72 mm (4-pole)
Device height	85 mm including rail clip
Frame size	45 mm
Mounting	easy fastening onto 35 mm device rail (DIN)
Degree of protection	IP20
Terminals	lift
Terminal capacity	1 — 35 mm ²
Fastening torque of terminals	1.5 — 2.5 Nm
Ambient temperature	-5 — +40 °C
Altitude	≤ 2000 m
Relative humidity	≤ 95 %
Resistance to humidity and heat	class 2
Pollution degree	2
Installation class	III
Weight	0.22 kg (2-pole), 0.4 kg (4-pole)

Technical Data Ex9CL-100

Residual Current Circuit Breakers up to 100 A, 10 kA

Dimensions

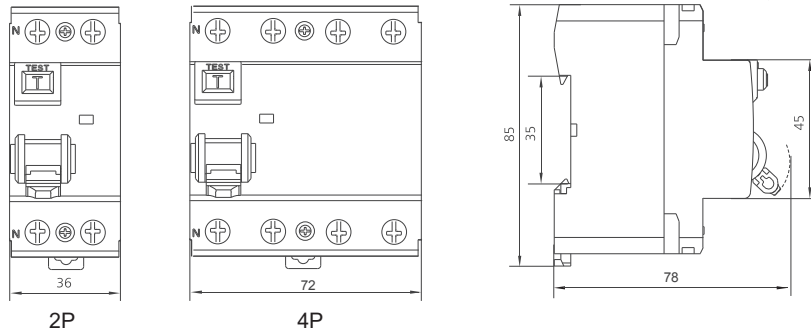

Wiring diagrams

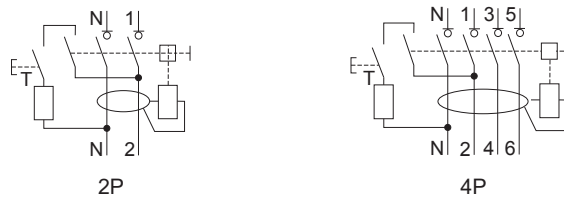

Technical Data Ex9CL-100

Residual Current Circuit Breakers up to 100 A, 10 kA

Tripping characteristics

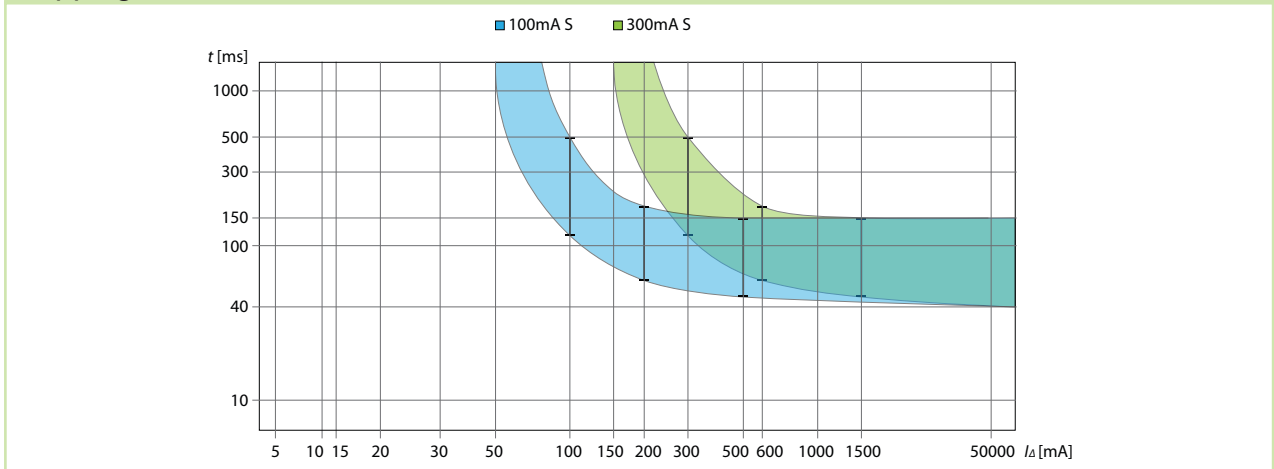

Power loss

I_n [A]		63 A		80 A		100 A	
I_{Δ} [mA]		100 mA	300 mA	100 mA	300 mA	100 mA	300 mA
P [W]	2P	7.2	7.2	8.3	8.1	10.5	10.1
	4P	13.3	11.7	14.5	14.2	17.7	16.9

Technical Data Ex9LB63

Residual Current Circuit Breakers type B, 10 kA

General parameters

Electronic evaluation principle - more accurate measuring of residual current
Suitable for household as well as industrial applications
B type - sensitivity to residual AC, pulsating and smooth DC current, high frequency up to 1 kHz
Device must be tested regularly. Local laws or regulations can be applied. Recommend is a testing period of 6 months in normal condition, 1 month in heavy conditions
In case all wires are not connected at 4-pole RCCB, it is necessary to ensure that circuit of the test button T is supplied with appropriate voltage (by means of mutual connection of respective terminals of the RCCB, see wiring diagram)
Internal SPD protection to improve service life and make it applicable to multiple installation environments
Parallel construction of the type A/AC and type B internal parts. If required voltage is not available for type B internal electronics, the protection type A and AC will be still provided
Indication of electrical tripping

Electrical parameters

Tested according to	IEC/EN 61008-1, IEC/EN 62423
Rated operational voltage U_e	230/240 V AC (2-pole) 400/415 V AC (4-pole)
Min. voltage for RCD function	voltage independent for type A and AC voltage dependent for type B (from 85 V AC)
Voltage range of the test button T	150 — 254 V AC (2-pole) 150 — 440 V AC (4-pole)
Rated frequency f	50 Hz
Conditional short circuit strength I_{nc}	10 kA
Rated current I_n	25, 40, 63 A
Rated residual current $I_{\Delta n}$	30, 100, 300 mA
Sensitivity to residual current	B type - residual AC, pulsating and smooth DC current, high frequency (1 kHz)
Rated impulse withstand voltage U_{imp}	4 kV
Rated insulation voltage U_i	500 V
Surge current proof	3000 A
Mechanical service life	10 000 operation cycles
Electrical service life	2 000 operation cycles
Back-up fuse for overload	
$I_n = 25$ A	max. 25 A gG
$I_n = 40$ A	max. 32 A gG
$I_n = 63$ A	max. 50 A gG
Back-up fuse for short circuit	
$I_n = 25$ A	max. 63 A gG
$I_n = 40$ A	max. 63 A gG
$I_n = 63$ A	max. 63 A gG
Rated making capacity I_m (rated residual making capacity $I_{\Delta m}$)	
$I_n = 25$ A	500 A
$I_n = 40$ A	500 A
$I_n = 63$ A	630 A
Line voltage connection	arbitrary above or below

Technical Data Ex9LB63

Residual Current Circuit Breakers type B, 10 kA

Mechanical parameters

Device width	54 mm (2-pole), 72 mm (4-pole)
Device height	91 mm including rail clip
Frame size	45 mm
Mounting	easy fastening onto 35 mm device rail (DIN)
Degree of protection	IP20
Terminals	combined lift + open mouthed
Terminal capacity	1 — 25 mm ²
Fastening torque of terminals	2.5 Nm
Busbar thickness	0.8 — 2 mm
Ambient temperature	-25 — +40 °C
Altitude	≤ 2000 m
Relative humidity	≤ 95 %
Resistance to humidity and heat	class 2
Pollution degree	2
Installation class	III
Weight	0.28 kg (2-pole), 0.43 kg (4-pole)

Dimensions

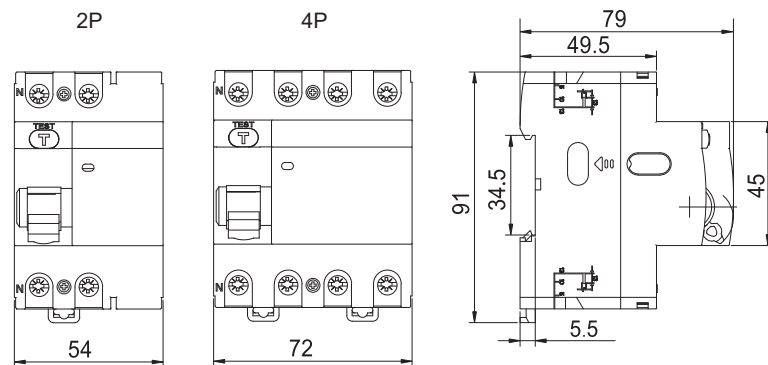

Wiring diagrams

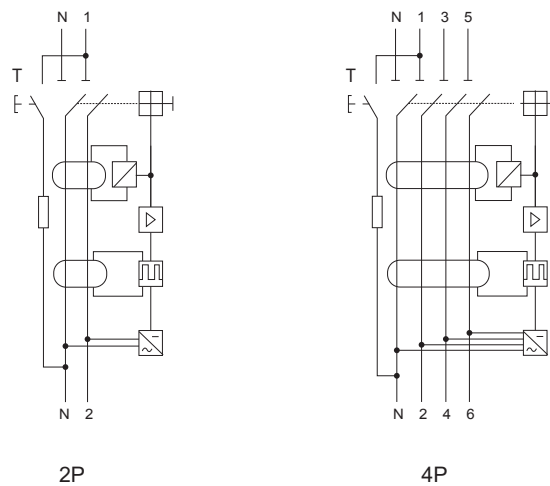

Technical Data Ex9LB63

Residual Current Circuit Breakers type B, 10 kA

Tripping characteristics

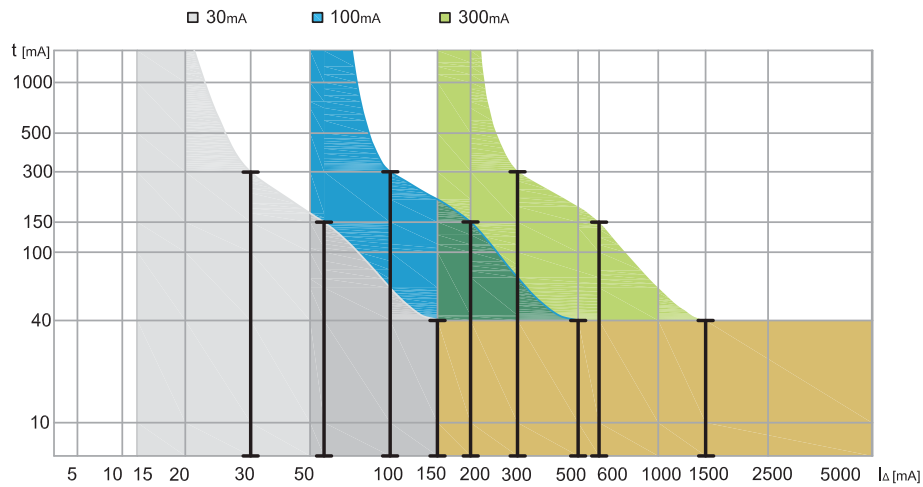

Power loss

I_n	I_{Δ}	2P	4P
25 A	30 mA	6.6 W	8.6 W
	100 mA	4.3 W	8.6 W
	300 mA	4.3 W	8.6 W
40 A	30 mA	6.9 W	13.7 W
	100 mA	10.5 W	13.7 W
	300 mA	10.5 W	13.7 W
63 A	30 mA	16.5 W	21.6 W
	100 mA	10.9 W	21.6 W
	300 mA	10.9 W	21.6 W

Technical Data Ex9BL-H

Residual Current circuit Breakers with Overload protection Ex9BL-H, 10 kA

General parameters

Combination of MCB and RCCB in one case - saves 50 % space in comparison to combination of stand-alone MCB and RCCB
Tripping characteristics of installed circuit breaker B and C
AC and A type of residual current device
1+N-pole version
Suitable for household as well as industrial applications
Permanent magnet principle of residual current device - Voltage independent tripping function
Magnetic RCBOs should be tested regularly with a period of one month. This is a responsibility of the user of an installation given by law
Signaling of contacts status

Electrical parameters

Tested according to	EN 61009
Rated operating voltage U_e	230 V AC
Min. voltage for RCD function	voltage independent
Voltage range of the test button T	195.5 — 253 V AC
Rated frequency f	50/60 Hz
Rated breaking capacity I_{cn}	10 kA
Rated current I_n	6 — 40 A
Rated residual current $I_{\Delta n}$	30, 100, 300 mA
Sensitivity to residual current	AC type - AC residual current A type - residual AC and pulsating DC current
Time characteristic of RCD	undelayed type
Tripping characteristics of MCB	B, C
Rated impulse withstand voltage U_{imp}	4 kV
Rated insulation voltage U_i	500 V
Surge current proof	3000 A
Mechanical service life	20 000 operation cycles
Electrical service life	4 000 operation cycles
Selectivity class	3
Back-up fuse/breaker	max. 125 A gG
Line voltage connection	arbitrary above or below

Mechanical parameters

Device width	36 mm
Device height	85 mm (including rail clip)
Frame size	45 mm
Mounting	easy fastening onto 35 mm device rail (DIN)
Degree of protection	IP20
Terminals	combined lift + open mouthed
Terminal capacity	1 — 25 mm ²
Fastening torque of terminals	1.5 — 2.5 Nm
Busbar thickness	0.8 — 2 mm
Ambient temperature	-25 — +40 °C
Altitude	≤ 2000 m
Relative humidity	≤ 95 %
Resistance to humidity and heat	class 2
Pollution degree	2
Installation class	III
Weight	0.2 kg

Technical Data Ex9BL-H

Residual Current circuit Breakers with Overload protection Ex9BL-H, 10 kA

Dimensions

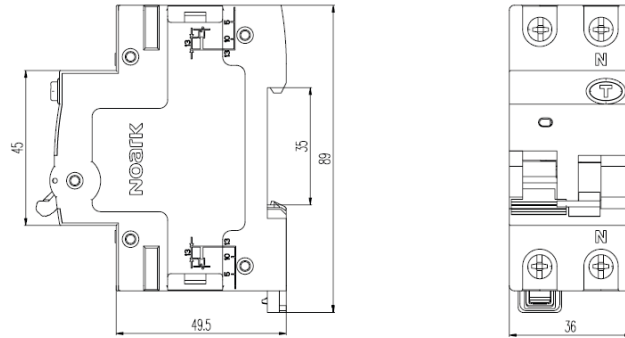

Wiring diagram

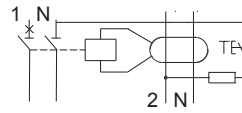

1P+N

Tripping characteristics of MCB

Characteristic B

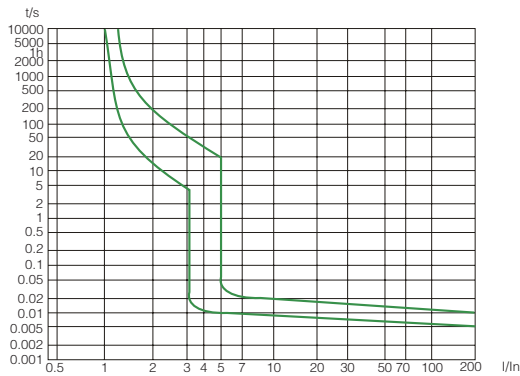

Characteristic C

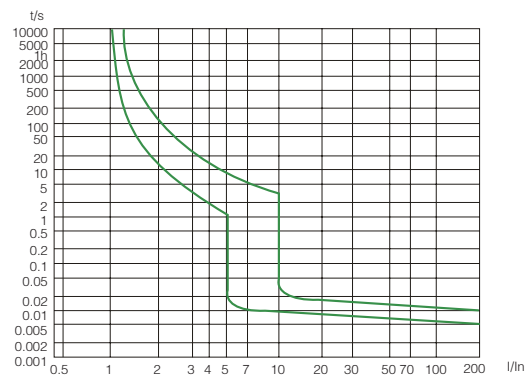

Tripping characteristics of RCD

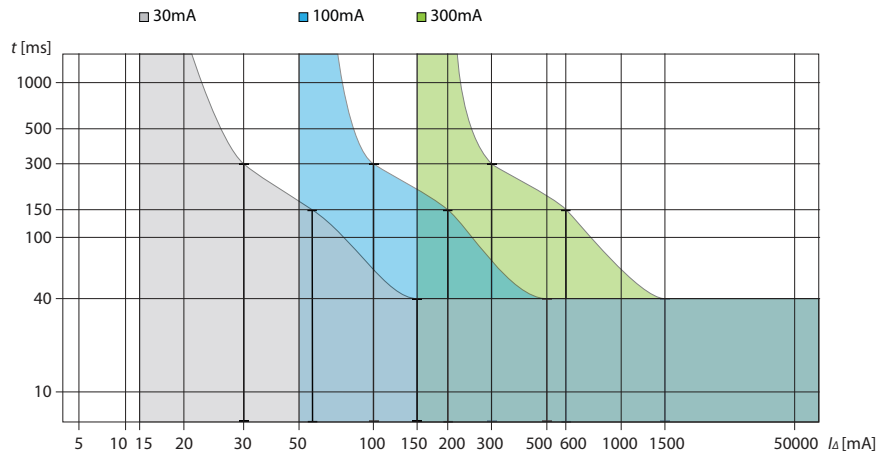

Technical Data Ex9BL-H

Residual Current circuit Breakers with Overload protection Ex9BL-H, 10 kA

Dependence of Tripping Characteristics on Ambient Temperature

T [°C]	I _n (T) [A]							
	6 A	10 A	13 A	16 A	20 A	25 A	32 A	40 A
-20	8	13.5	17	20	24.5	29.8	39.5	50.5
-15	7.8	13.3	16.8	19.8	24.3	29.7	39.3	50.4
-10	7.6	13	16.5	19.5	24	29.5	39	50.2
-5	7.3	12.7	16.1	19.2	23.8	29.3	38.8	50
0	7.2	12.5	15.8	19.1	23.7	29.2	38.6	48.8
5	7	12.3	15.5	18.8	23.5	29	38.4	48.6
10	6.8	12.1	15.2	18.6	23.3	28.8	38.2	48.4
15	6.6	12	14.9	18.5	23.1	28.6	38	48.1
20	6.4	11.8	14.7	18.3	22.8	28.4	37.8	47.8
25	6.2	11.5	14.1	18	22.6	28.2	37.5	47
30	6	10	13	16	20	25	32	40
35	6	9.9	12.8	15.7	19.7	24.6	31.5	39.2
40	5.9	9.8	12.5	15.4	19.3	24.3	31.1	38.8
45	5.83	9.8	12.2	15.1	18.8	24	30.8	38.3
50	5.72	9.6	11.7	14.9	18.5	23.8	30.1	38
55	5.65	9.5	11.5	14.7	18.2	23.5	29.5	36.5
60	5.5	9	11.2	14.5	17.8	23	28.5	35
65	5.4	8.6	11	14	17.5	22	27.5	34
70	5.2	8	10.8	13.8	17.3	21.5	27	32.5

Power loss

I _n [A]	6 A	10 A	13 A	16 A	20 A	25 A	32 A	40 A
P [W]	1,8	2,5	3,5	4	5	5,8	6,5	7,8

Technical Data Ex9BL-N

Residual Current current Breakers with Overload protection Ex9BL-N, 6 kA

General parameters

Combination of MCB and RCCB in one case - saves 50 % space in comparison to combination of stand-alone MCB and RCCB
Tripping characteristics of installed circuit breaker B and C
AC and A type of residual current device
1+N-pole version
Suitable for household as well as industrial applications
Permanent magnet principle of residual current device - Voltage independent tripping function
Magnetic RCBOs should be tested regularly with a period of one month. This is a responsibility of the user of an installation given by law
Signaling of contacts status

Electrical parameters

Tested according to	EN 61009
Rated operating voltage U_e	230 V AC
Min. voltage for RCD function	voltage independent
Voltage range of the test button T	195.5 — 253 V AC
Rated frequency f	50/60 Hz
Rated breaking capacity I_{cn}	6 kA
Rated current I_n	6 — 40 A
Rated residual current $I_{\Delta n}$	30, 100, 300 mA
Sensitivity to residual current	AC type - AC residual current A type - residual AC and pulsating DC current
Time characteristic of RCD	undelayed type
Tripping characteristics of MCB	B, C
Rated impulse withstand voltage U_{imp}	4 kV
Rated insulation voltage U_i	500 V
Surge current proof	3000 A
Mechanical service life	20 000 operation cycles
Electrical service life	4 000 operation cycles
Selectivity class	3
Back-up fuse/breaker	max. 125 A gG
Line voltage connection	arbitrary above or below

Mechanical parameters

Device width	36 mm
Device height	85 mm (including rail clip)
Frame size	45 mm
Mounting	easy fastening onto 35 mm device rail (DIN)
Degree of protection	IP20
Terminals	combined lift + open mouthed
Terminal capacity	1 — 25 mm ²
Fastening torque of terminals	1.5 — 2.5 Nm
Busbar thickness	0.8 — 2 mm
Ambient temperature	-25 — +40 °C
Altitude	≤ 2000 m
Relative humidity	≤ 95 %
Resistance to humidity and heat	class 2
Pollution degree	2
Installation class	III
Weight	0.2 kg

Technical Data Ex9BL-N

Residual Current current Breakers with Overload protection Ex9BL-N, 6 kA

Dimensions

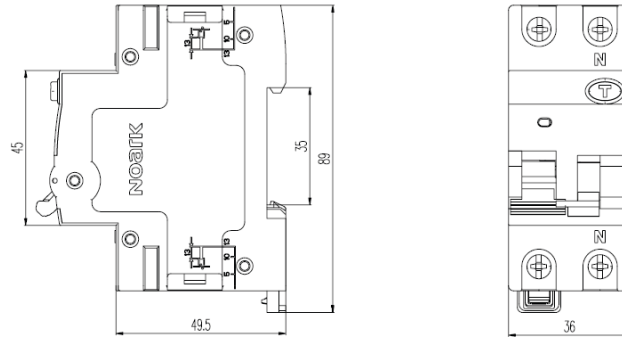

Wiring diagram

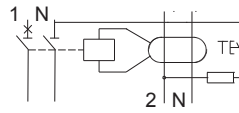

1P+N

Tripping characteristics of MCB

Characteristic B

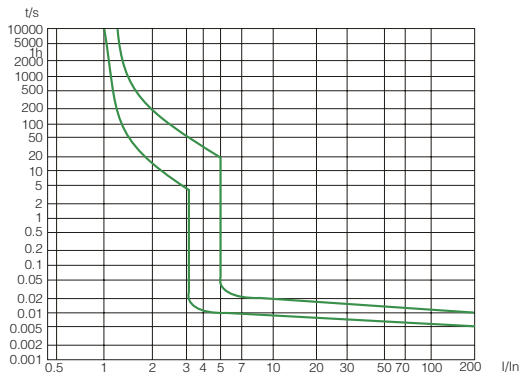

Characteristic C

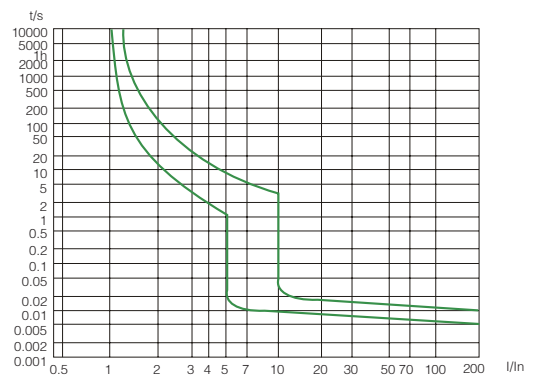

Tripping characteristics of RCD

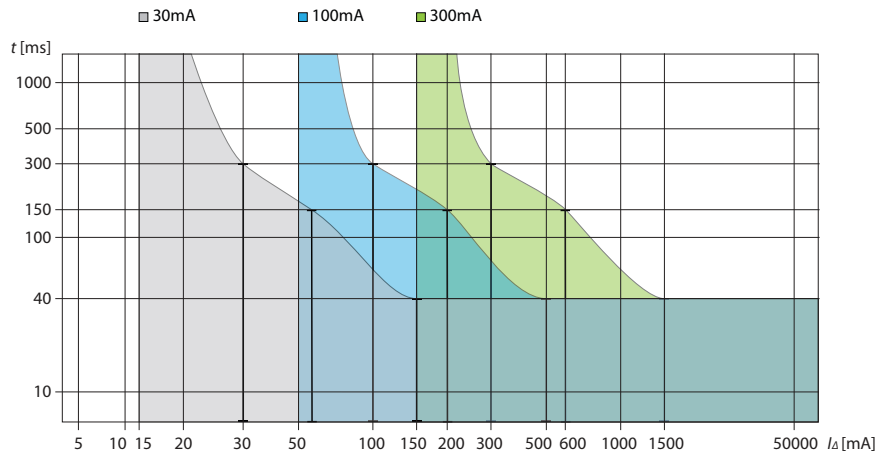

Technical Data Ex9BL-N

Residual Current current Breakers with Overload protection Ex9BL-N, 6 kA

Dependence of Tripping Characteristics on Ambient Temperature

T [°C]	I _n (T) [A]							
	6 A	10 A	13 A	16 A	20 A	25 A	32 A	40 A
-20	8	13.5	17	20	24.5	29.8	39.5	50.5
-15	7.8	13.3	16.8	19.8	24.3	29.7	39.3	50.4
-10	7.6	13	16.5	19.5	24	29.5	39	50.2
-5	7.3	12.7	16.1	19.2	23.8	29.3	38.8	50
0	7.2	12.5	15.8	19.1	23.7	29.2	38.6	48.8
5	7	12.3	15.5	18.8	23.5	29	38.4	48.6
10	6.8	12.1	15.2	18.6	23.3	28.8	38.2	48.4
15	6.6	12	14.9	18.5	23.1	28.6	38	48.1
20	6.4	11.8	14.7	18.3	22.8	28.4	37.8	47.8
25	6.2	11.5	14.1	18	22.6	28.2	37.5	47
30	6	10	13	16	20	25	32	40
35	6	9.9	12.8	15.7	19.7	24.6	31.5	39.2
40	5.9	9.8	12.5	15.4	19.3	24.3	31.1	38.8
45	5.83	9.8	12.2	15.1	18.8	24	30.8	38.3
50	5.72	9.6	11.7	14.9	18.5	23.8	30.1	38
55	5.65	9.5	11.5	14.7	18.2	23.5	29.5	36.5
60	5.5	9	11.2	14.5	17.8	23	28.5	35
65	5.4	8.6	11	14	17.5	22	27.5	34
70	5.2	8	10.8	13.8	17.3	21.5	27	32.5

Power loss

I _n [A]	6 A	10 A	13 A	16 A	20 A	25 A	32 A	40 A
P [W]	1.8	2.5	3.5	4	5	5.8	6.5	7.8

Technical Data Ex9NLE

One-module Residual Current circuit Breakers with Overload protection Ex9NLE, 6 kA

General parameters

Saves one modular space in comparison to classical RCBO
Tripping characteristics of integrated circuit breaker B and C
AC and A type of residual current device
1+N-pole version
Electronic evaluation principle - more accurate measuring of residual current
Voltage dependent RCBO
The insulation test must be performed in the top terminals and with the device in the OFF position
Device must be tested regularly. Local law or regulations may apply on utilization and testing period. Recommend is a testing period of 6 months in normal condition, 1 month in heavy conditions

Electrical parameters

Tested according to	EN 61009-1
Rated operating voltage U_e	230 V AC
Min. voltage for RCD function	50 V AC
Voltage range of the test button T	195.5 — 253 V AC
Rated frequency f	50/60 Hz
Rated breaking capacity I_{cn}	6 kA
Rated current I_n	6 — 40 A
Rated residual current $I_{\Delta n}$	30 mA
Rated residual non-operating current $I_{\Delta no}$	15 mA
Sensitivity to residual current	AC type - AC residual current A type - residual AC and pulsating DC current
Time characteristic of RCD	no time delay
Tripping characteristics of MCB	B, C
Rated impulse withstand voltage U_{imp}	4 kV
Rated insulation voltage U_i	500 V
Surge current proof	3000 A
Mechanical service life	10 000 operation cycles
Electrical service life	4 000 operation cycles
Selectivity class	3
Line voltage connection	from top or bottom connection

Mechanical parameters

Device width	18 mm
Device height	95 mm (including rail clip)
Frame size	45 mm
Mounting	easy fastening onto 35 mm device rail (DIN)
Degree of protection	IP20
Terminals	combined lift + open mouthed
Terminal capacity	1 — 16 mm ²
Fastening torque of terminals	1.5 Nm
Busbar thickness	0.8 — 1 mm
Ambient temperature	-35 — +70 °C
Altitude	≤ 2000 m
Relative humidity	≤ 95 %
Resistance to humidity and heat	class 2
Pollution degree	2
Installation class	III

Technical Data Ex9NLE

One-module Residual Current circuit Breakers with Overload protection Ex9NLE, 6 kA

Dimensions

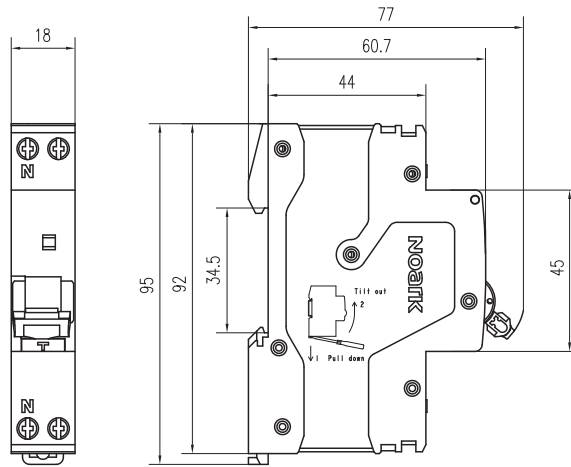

Wiring diagram

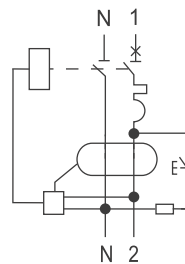

Tripping characteristics of MCB

Characteristic B

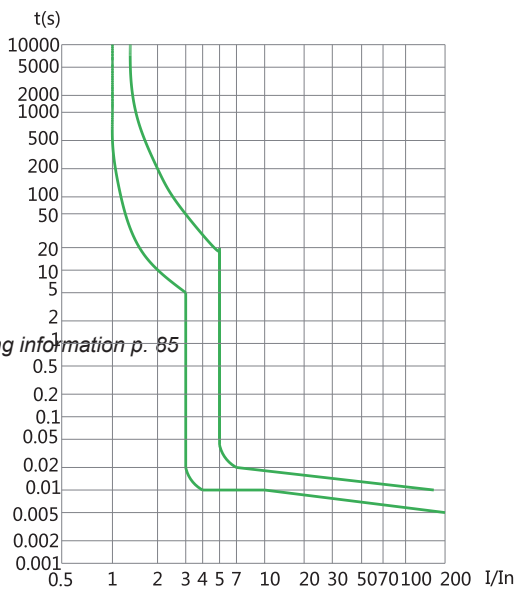

Characteristic C

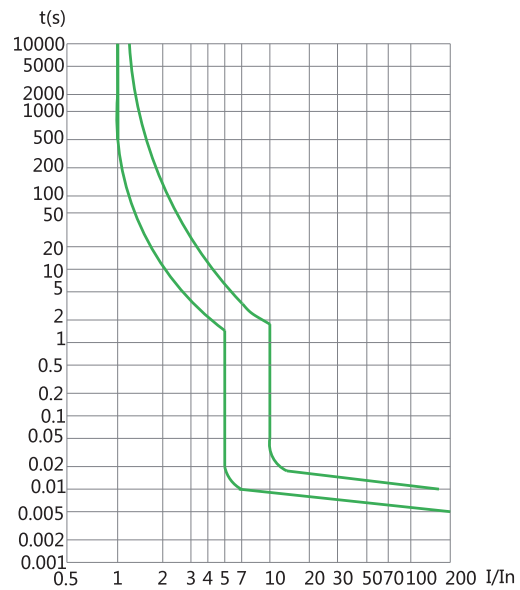

Ordering information p. 85

Technical Data Ex9NLE

One-module Residual Current circuit Breakers with Overload protection Ex9NLE, 6 kA

Tripping characteristics of RCD

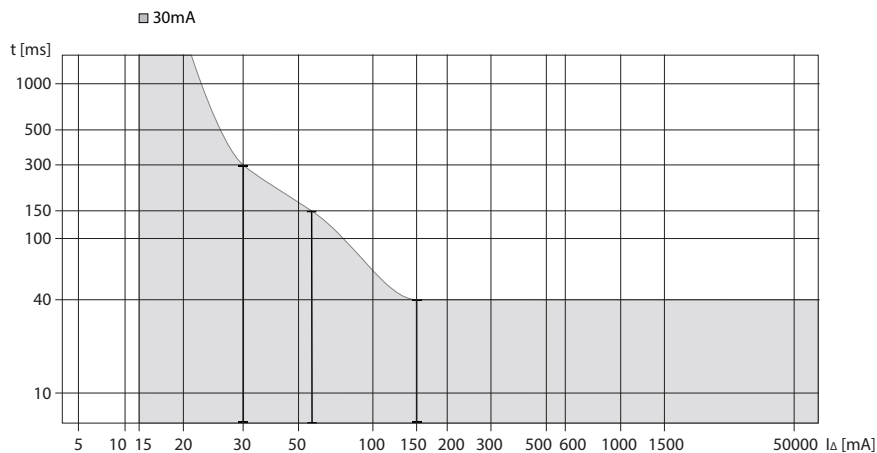

Dependence of tripping characteristics on ambient temperature

T [°C]	I _n (T) [A]						
	6 A	10 A	16 A	20 A	25 A	32 A	40 A
-35	7.68	12.7	20.32	25.4	31.75	40.64	51.6
-20	7.5	12.4	19.84	24.8	31	39.68	50.4
-10	7.08	11.9	19.04	23.8	29.75	38.08	48.4
0	6.78	11.3	18.08	22.6	28.25	36.16	46
10	6.48	10.7	17.12	21.4	26.75	34.56	44
20	6.18	10.2	16.32	20.4	25.5	32.96	42
30	6	10	16	20	25	32	40
40	5.76	9.6	15.52	19.4	24	31.04	38.8
50	5.46	9.1	15.04	18.8	22.75	29.76	36.8
60	5.22	8.7	14.4	18	22	28.16	35.2
70	7.92	8.2	14.08	17.6	21.25	26.56	33.2

Power loss

I _{cn} [A]	6 A	10 A	16 A	20 A	25 A	32 A	40 A
L / N [W]	1.94 / 0.06	1.83 / 0.08	2.09 / 0.22	2.44 / 0.37	2.93 / 0.86	5.58 / 3.55	5.58 / 3.55

Technical Data Ex9NL-N 3P+N

Residual Current Breakers with Overload protection Ex9NL-N 3P+N, 6 kA

General parameters

Combination of MCB and RCCB in one case - saves 50 % space in comparison to combination of stand-alone MCB and RCCB
Tripping characteristics of installed circuit breaker B and C
AC and A type of residual current device
3+N-pole version
Suitable for household as well as industrial applications
Permanent magnet principle of residual current device - Voltage independent tripping function
Recommend is to test device every 6 months in fair environment and every month in heavy condition.
Signaling of contacts status

Electrical parameters

Tested according to	IEC/EN 61009-1
Rated op. voltage U_e	400 V AC
Min. voltage for RCD function	voltage independent
Voltage range of the test button T	340 — 440 V AC
Rated frequency	50/60 Hz
Rated breaking capacity I_{cn}	6 kA
Rated current	6 — 40 A
Rated residual current	30, 300 mA
Sensitivity to residual current	AC type - AC residual current A type - residual AC and pulsating DC current
Time characteristic of RCD	undelayed type
Tripping characteristics of MCB	B, C
Rated impulse withstand voltage U_{imp}	4 kV
Rated insulation voltage U_i	500 V
Surge current proof	3000 A
Mechanical service life	10 000 operation cycles
Electrical service life	2 000 operation cycles
Selectivity class	3
Back-up fuse/breaker	max. 125 A gG
Line voltage connection	arbitrary above or below

Mechanical parameters

Device width	72 mm
Device height	82 mm including rail clip
Frame size	45 mm
Mounting	easy fastening onto 35 mm device rail (DIN)
Degree of protection	IP20
Terminals	combined lift + open mouthed
Terminal capacity	1 — 16 mm ²
Fastening torque of terminals	2 N m
Busbar thickness	0.8 — 1.5 mm
Ambient temperature	-25 — +40 °C
Altitude	≤ 2000 m
Relative humidity	≤ 95 %
Resistance to humidity and heat	class 2
Pollution degree	2
Installation class	III
Weight	0.432 kg

Technical Data Ex9NL-N 3P+N

Residual Current Breakers with Overload protection Ex9NL-N 3P+N, 6 kA

Dimensions

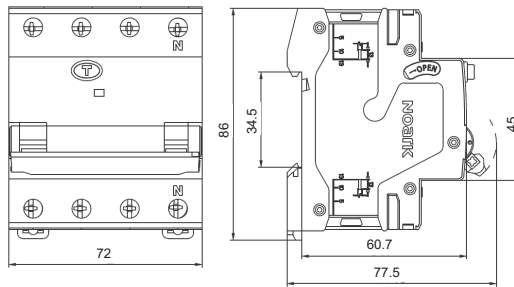

Wiring diagram

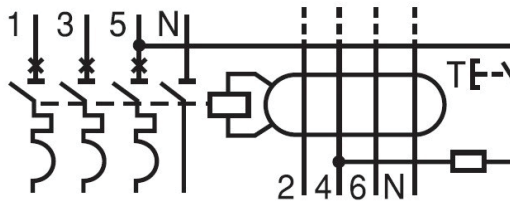

Tripping characteristics of MCB

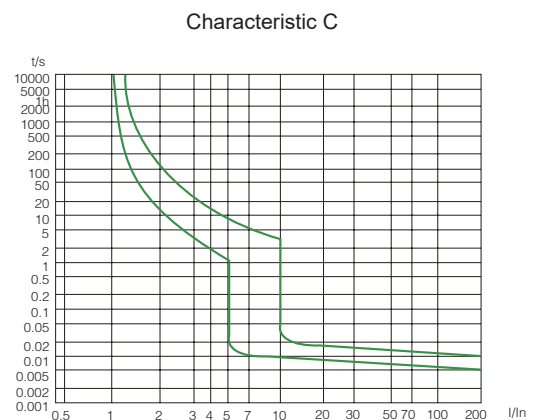
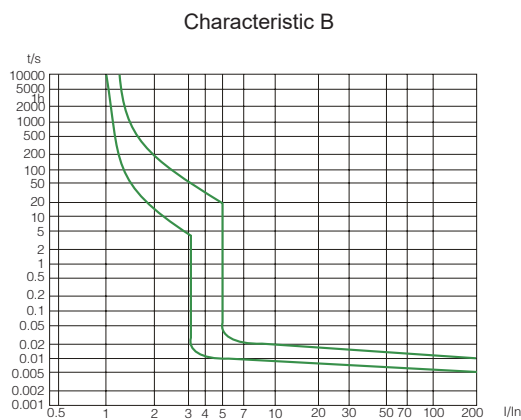

Tripping characteristics of RCD

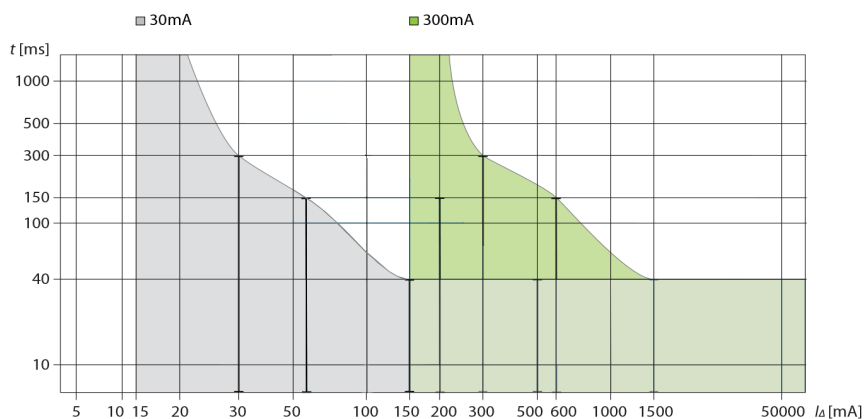

Technical Data Ex9NL-N 3P+N

Residual Current Breakers with Overload protection Ex9NL-N 3P+N, 6 kA

Dependence of Tripping Characteristics on Ambient Temperature

T [°C]	I _n (T) [A]							
	6 A	10 A	13 A	16 A	20 A	25 A	32 A	40 A
-10	7.2	12	15.6	19.2	24	30	38.4	48
0	6.9	11.5	14.95	18.4	23	28.75	36.8	46
10	6.6	11	14.3	17.6	22	27.5	35.2	44
20	6.3	10.5	13.65	16.8	21	26.25	33.6	42
30	6	10	13	16	20	25	32	40
40	5.7	9.5	12.35	15.2	19	23.75	30.4	38
50	5.4	9	11.7	14.4	18	22.5	28.8	36
60	5.1	8.5	11.05	13.6	17	21.25	27.2	34

Power loss

I _n [A]	6 A	10 A	13 A	16 A	20 A	25 A	32 A	40 A
P [W]	2.8	5.3	5.3	8.4	6.9	10.7	14.6	17.8

Technical Data Ex9LE

RCD add-on blocks Ex9LE

General parameters

RCD add-on blocks for combination with miniature circuit breakers Ex9B
Allow to create various combinations with MCBs with functionality of RCBO
AC type of residual current device
1+N, 2, 3, 3+N and 4-pole versions
Input voltage is connected via MCB
Electronic technology of residual current device - more accurate measuring of residual current, not necessary to test monthly.
Recommended testing period one year to fulfill requirements of product standards. Contrary to permanent magnet-based devices, the testing is not necessary to preserve proper sensitivity of the RCD
Given pole version of the RCD add-on block must be combined with MCB Ex9B in the following way. 1+N-pole version of RCD add-on block is possible to combine with 1-pole MCB; 2-pole RCD block with 1+N or 2-pole MCB; 3-pole and 3+N-pole RCD block with 3-pole MCB, 4-pole RCD block with 3+N or 4-pole MCB

Electrical parameters

Tested according to	IEC / EN 61009-1
Rated op. voltage U_e	230/400 V AC
Min. voltage for RCD function	50 V AC
Voltage range of the test button T	150 — 440 V AC
Rated frequency	50/60 Hz
Conditional short circuit strength I_{nc}	10 kA with Ex9BH, 6 kA with Ex9BN
Rated current (max. rated current of connected MCB)	40, 63 A
Rated residual current	10, 30, 100, 300 mA
Sensitivity to residual current	AC type - AC residual current
Time characteristic of RCD	undelayed type
Rated impulse withstand voltage U_{imp}	4 kV
Rated insulation voltage U_i	500 V
Surge current-proof	250 A
Mechanical service life	16 000 operation cycles
Electrical service life	8 000 operation cycles
Back-up fuse/breaker	co-installed MCB
Line voltage connection	above to MCB

Mechanical parameters

Device width (without MCB busbar)	54 mm (1+N-pole), 72 mm (2-pole), 117 mm (3-pole), 117 mm (3+N-pole), 135 mm (4-pole)
Device height	89 mm including rail clip and connection busbar
Frame size	45 mm
Mounting	easy fastening onto 35 mm device rail (DIN)
Degree of protection	IP20
Terminals	combined lift + open mouthed
Terminal capacity	1 — 35 mm ²
Fastening torque of terminals	2 — 3.5 Nm
Busbar thickness	0.8 — 2 mm
Ambient temperature	-25 — +40 °C
Altitude	≤ 2000 m
Relative humidity	≤ 95 %
Resistance to humidity and heat	class 2
Pollution degree	2
Installation class	III

Technical Data Ex9LE

RCD add-on blocks Ex9LE

Dimensions

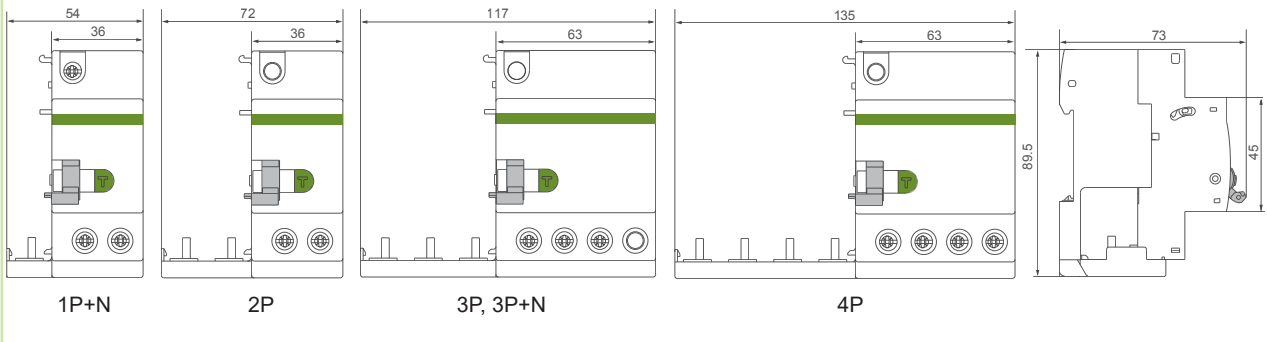

Wiring diagrams

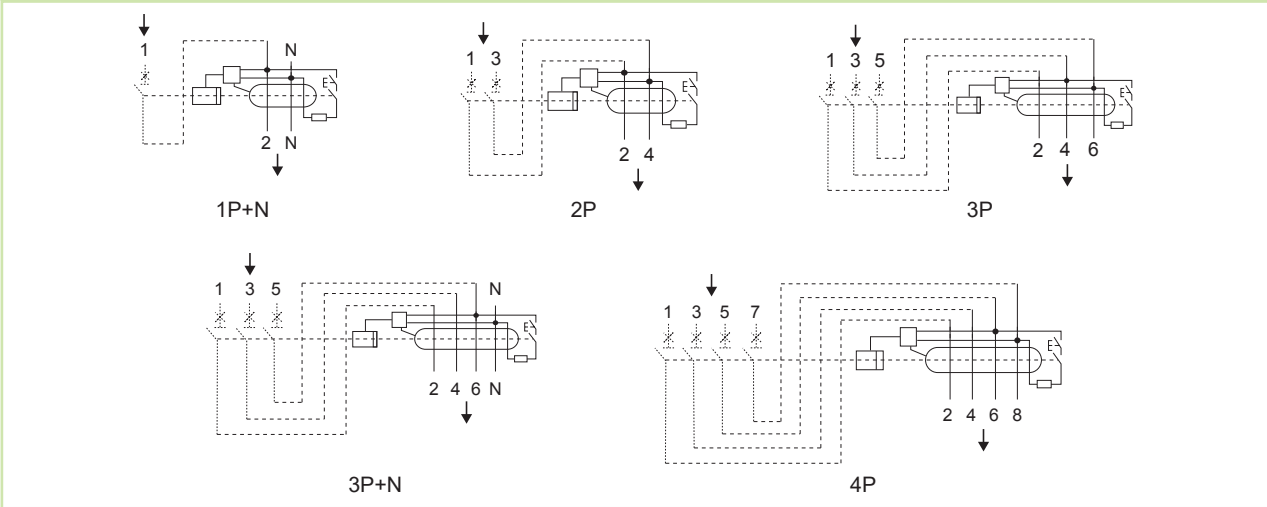

Tripping characteristics of RCD

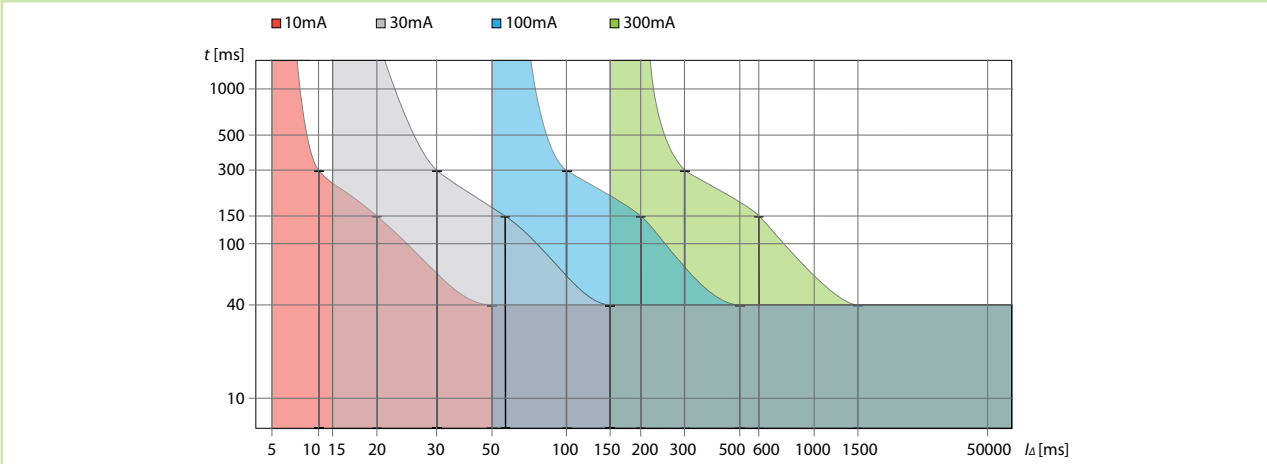

Technical Data Ex9EM

Energy Meters

General parameters

1 or 4 Module width versions

Electrical parameters

	Ex9EM 1P 1M 32A 1T	Ex9EM 1P 1M 45A 1T	Ex9EM 1P 1M 45A 1T MCH
Tested according to	EN 62052-11, EN 62053-21		
Rated operating voltage U_e	230 V AC \pm 20%		
Rated frequency f	50 Hz \pm 10%		
Rated current I_e (I_{max})	0.25 - 5(32) A	0.25 - 5(45) A	
Poles	1		
Communication	-		
Connection mode	Direct		
Rated insulation voltage U_i	4 kV		
Power consumption	\leq 8 VA		
Impulse output	1 000		
Display	LCD 5+2	LCD 5+2	Mechanical counter 5+1
LCD Total Energy	Forward + Reverse		
Accuracy class	1		
Battery	-		
Starting current	$0.004 \cdot I_e$		
Measurement type	Active Energy		
Pulse output	1 000 Imp/kWh $R_L = 1 \text{ Wh/Imp}$ $R_A = 1 \text{ Wh/Imp}$ S0 - Standard DIN 43864		
Pulse width	80 ms		
LED	Impulse rate = Usage		
Registered harmonics range	0.05 - 0.25 kHz		

Mechanical parameters

Device width	18 mm		
Device height	91 mm (without covers), 120 mm		
Frame size	45 mm		
Mounting	onto 35 mm device rail (DIN)		
Degree of protection			
with terminal covers	IP 51	IP 51	IP 50
without terminal covers	IP 50	IP 50	IP 50
Terminals	screw terminals		
Max. terminal capacity	12 mm ²		
Fastening torque of terminals	1.5 Nm	1.5 Nm	1.0 Nm
Ambient temperature	-25°C — +55°C		-20°C — +65°C
Max. rel. humidity	75% Average, 95% Short time		
Insulation class	II		
Sealable	yes		
Weight	0.082 kg		

Technical Data Ex9EM

Energy Meters

Electrical parameters

	Ex9EM 1P 1M 80A MO MT*	Ex9EM 3P 4M CT 1T	Ex9EM 3P 4M 80A 1T
Tested according to	EN 62052-11, EN 62053-21		
Rated operating voltage U_e	230 V AC \pm 20%	3x230/400 V AC \pm 20%	
Rated frequency f	50 Hz \pm 10%		50-60 Hz
Rated current I_e (I_{max})	5(80) A	1.5 - (6) A	5(80) A
Poles	1	3	3
Communication	ModBus	-	-
Connection mode	Direct	CT	Direct
Rated insulation voltage U_i	4 kV		
Power consumption	\leq 8 VA	\leq 10 VA	\leq 10 VA
Impulse output	1 000	12 000	800
Display	LCD 5+1	LCD 6+2	LCD 6+2
LCD Total Energy	Forward + Reverse		
Accuracy class	1		
Battery	Yes	-	Yes
Starting current	0.004* I_e		
Measurement type	Active and Reactive Energy	Active Energy	
Pulse output	1 000 Imp/kWh $R_L = 1$ Wh/Imp $R_A = 1$ Wh/Imp S0 - Standard DIN 43864	12 000 Imp/kWh $R_L =$ depend on the CT ratio $R_A =$ depend on the CT ratio S0 - Standard DIN 43864	800 Imp/kWh S0 - Standard DIN 43864
Pulse width	90 ms	35 ms	35 ms
LED	Impulse rate = Usage		
Registered harmonics range	-	0.05 - 0.25 kHz	

*Software for communication can be downloaded from our website www.noark-electric.eu.

Mechanical parameters

Device width	19.5 mm	76 mm	76 mm
Device height	97.2 mm	100 mm	100 mm
Frame size	45 mm		
Mounting	onto 35 mm device rail (DIN)		
Degree of protection			
with terminal covers	IP 50	IP 51	IP 51
without terminal covers	IP 50	IP 50	IP 50
Terminals	lift and screw terminals		
Max. terminal capacity	10 mm ²	18 mm ²	40 mm ²
Fastening torque of terminals	3 Nm	1.5 Nm	1.2 Nm
Ambient temperature	-25°C — +55°C	-20°C — +55°C	
Max. rel. humidity	75% Average, 95% Short time		
Insulation class	II		
Sealable	yes		
Weight	0.082 kg	0.278 kg	0.366 kg

Technical Data Ex9EM

Energy Meters

Dimensions

Ex9EM 1P 1M 32A 1T / Ex9EM 1P 1M 45A 1T

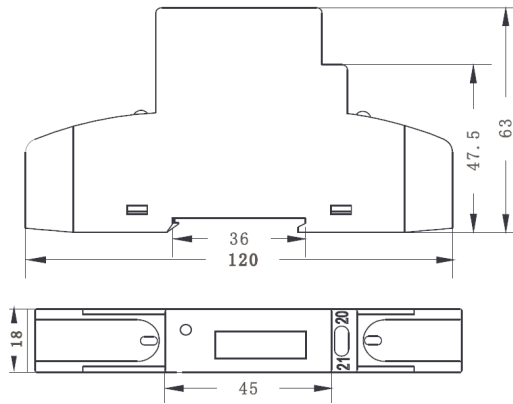

Ex9EM 1P 1M 45A 1T MCH

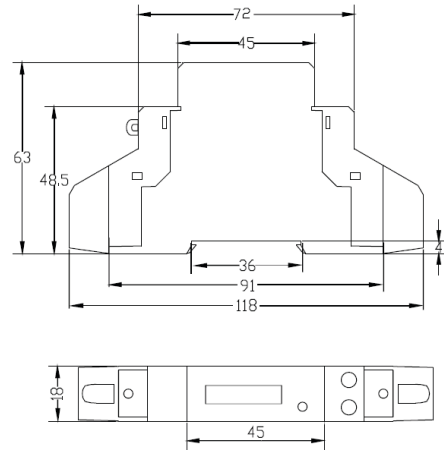

Ex9EM 1P 1M 80A MO MT

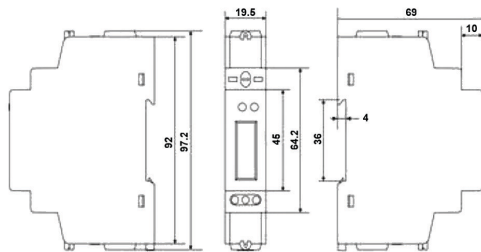

Ex9EM 3P 4M CT 1T / Ex9EM 3P 4M 80A 1T

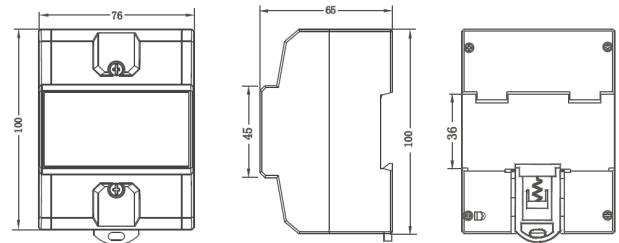

Wiring diagrams

Ex9EM 1P 1M 32A 1T
Ex9EM 1P 1M 45A 1T
Ex9EM 1P 1M 45A 1T MCH

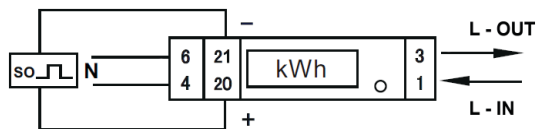

Ex9EM 1P 1M 80A MO MT

TERMINAL	DESCRIPTION
1	Line-IN
3	Line-OUT
23	A(RS485)
24	G(Earth)
25	B(RS485)

PRESS PAGE

IMPULSE INDICATION

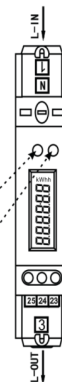

Ex9EM 3P 4M CT 1T

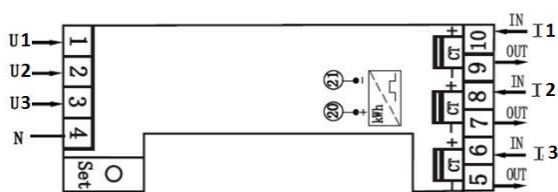

Ex9EM 3P 4M 80A 1T

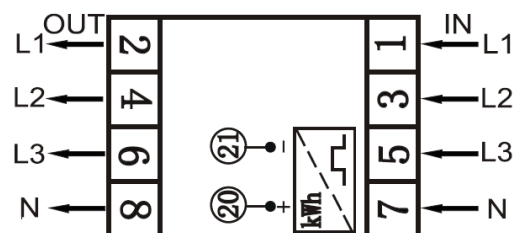

Technical Data Ex9EMS

Smart Energy Meters

General parameters

All products have MID certification

1 or 2-tariff versions

Optional M-Bus or ModBus communication

Direct or CT connection

Electrical parameters

	Ex9EMS 1P 1M	Ex9EMS 1P 2M	Ex9EMS 3P 4M
Tested according to	EN 50470-1/3		
Nominal voltage U_n	230 V AC	230 V AC	3x230/400 V AC
Operational voltage	195-253 V AC	195-253 V AC	3x230/400 V \pm 20%
Rated frequency f	50 Hz \pm 10%	50 Hz \pm 10%	45-60 Hz
Insulation capabilities:			
AC voltage withstand	4 kV for 1 minute		
Impulse voltage withstand	6 kV - 1.2 μ s waveform		
Basic current I_b	5 A	5 A	5 A (1.5 A for CT version)
Maximum rated current I_{max}	45 A	100 A	100 A (6 A for CT version)
Operational current range	0.4% I_b - I_{max}		
Overcurrent withstand	30* I_{max} for 0.01 s		
Power consumption (active - reactive)	\leq 2 W/phase - \leq 10 W/phase		
Test output flash rate (RED LED)	10 000 Imp/kWh		
Pulse output rate	10 000/2 000/1 000/100/10/1/0.1/0.01 Imp/kWh		
Pulse width	\leq 5 625 W ... 32 ms > 5 625 W ... 11.2 ms	1 000/100/10/1/0.1/0.01 Imp/kWh ... 31 ms 2 000 Imp/kWh < 30 kW ... 31 ms 2 000 Imp/kWh > 30 kW ... 15 ms 10 000 Imp/kWh < 6 kW ... 31 ms 10 000 Imp/kWh > 6 kW ... 15 ms 10 000 Imp/kWh > 12 kW ... 5 ms	1 000/2 000/10 000 pulses • 0 - 4 999 W ... 40 ms • 5 000 - 9 999 W ... 20 ms • 10 000-19 999 W ... 10ms • 20 000 - 39 999 W ... 5ms • > 40 000 W ... 2.5 ms 100 pulses • < 50 000 W ... 40 ms • > 50 000 W ... 20 ms Other pulses • always ... 40 ms
Data store	The data can be stored for more than 10 years without power		
Accuracy class	B (=1% accuracy)		
Basic errors:			
0.05* I_b	Cos ϕ = 1 ... \pm 1.5%		
0.1* I_b	Cos ϕ = 0.5L ... \pm 1.5% Cos ϕ = 0.5C ... \pm 1.5%		
0.1* I_b - I_{max}	Cos ϕ = 1 ... \pm 1.0%		
0.2* I_b - I_{max}	Cos ϕ = 0.5L ... \pm 1.0% Cos ϕ = 0.5C ... \pm 1.0%		
Infrared specification			
Infrared wavelengths	900 - 1 000 nm		
Communication distance	Direct contact		
Protocol	IEC62056-21:2002 (IEC1107)		
M-Bus com. spec. (MB version only)			
Bus type	M-Bus		
Baud rate	300, 600, 1 200, 2 400, 4 800, and 9 600 (default)		
Range	\leq 1 000 m		
Downlink signal	Master to slave. Voltage modulation		
Uplink signal	Slave to master. Current modulation		

Technical Data Ex9EMS

Smart Energy Meters

Electrical parameters

	Ex9EMS 1P 1M	Ex9EMS 1P 2M	Ex9EMS 3P 4M
M-Bus com. spec. (MB version only)			
Cable	JYSTY (nx2x0.8)		
Protocol	EN13757-3		
Max. number of meters	64*		
ModBus com. spec. (MO version only)			
Bus type	RS485		
Protocol	ModBus RTU with 16 bit CRC		
Baud rate	1 200, 2 400, 4 800 and 9 600 (default)		
Address range	1-247 user settable		
Maximum bus load	60 meters per bus*		
Range	1 000 m		

*Note that the maximum number of meters is dependent on the converter, baudrate (the higher the baudrate, the smaller the number of meters which can be used) and the circumstances under which the meters are installed.

Software for programing energy meters thru infrared eye can be downloaded from our website www.noark-electric.eu.

For more informations and settings of Smart Energy Meters please see User Manual from our website.

Mechanical parameters

	Ex9EMS 1P 1M	Ex9EMS 1P 2M	Ex9EMS 3P 4M
Device width	17.5 mm	35.8 mm	70 mm
Device height	90 mm	92.5 mm	92.4 mm
Frame size	45 mm		
Mounting	onto 35 mm device rail (DIN)		
Degree of protection	IP 50		
Terminals	lift and screw terminals		
Max. L and N terminals capacity			
Solid copper	8 mm ²	35 mm ²	35 mm ²
Flex core	-	-	25 mm ²
Fastening torque of L and N terminals	2.4 Nm		
Max. Auxiliary terminals capacity	2.5 mm ²		
Fastening torque of auxiliary terminals	0.1 Nm		
Ambient temperature	-25°C — +55°C	-40°C — +70°C	Direct: -40°C — +70°C CT: -25°C — +70°C
Operating humidity	≤ 75%		
Insulation class	II		
Weight	0.08 kg	0.16 kg	0.39 kg

Dimensions

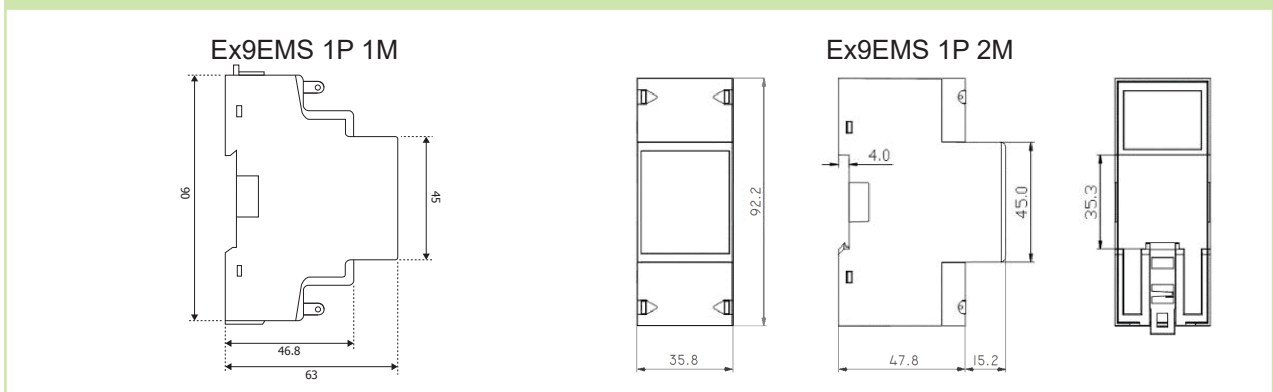

Technical Data Ex9EMS

Smart Energy Meters

Dimensions

Ex9EMS 3P 4M

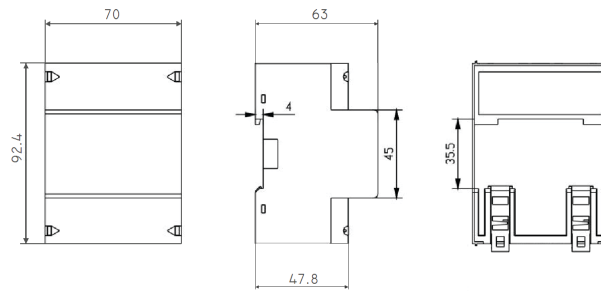

Wiring diagrams

Ex9EMS 1P 1M

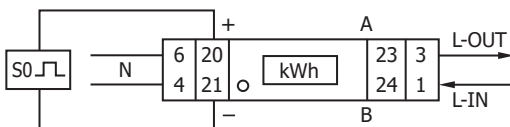

- | | | |
|-------|---------------------------|------------------------------|
| 1 | Phase line in (L-IN) | |
| 3 | Phase line out (L-OUT) | |
| 4 | Neutral line in (N) | |
| 6 | Neutral line out (N) | |
| 20/21 | Pulse output contact (S0) | |
| 23/24 | Ex9EMS 1P 1M 45A 1T | Not in use |
| | Ex9EMS 1P 1M 45A 2T | External tariff input (230V) |
| | Ex9EMS 1P 1M 45A MB 2T | M-Bus communication contact |
| | Ex9EMS 1P 1M 45A MO 2T | ModBus communication contact |

Ex9EMS 1P 2M

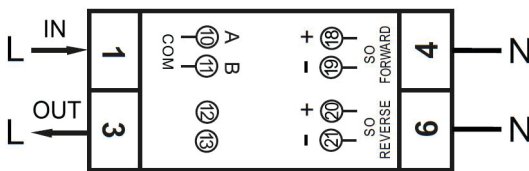

- | | | |
|-------|--|--|
| 1 | Phase line in (L-IN) | |
| 3 | Phase line out (L-OUT) | |
| 4 | Neutral line in (N) | |
| 6 | Neutral line out (N) | |
| 10/11 | M-Bus/ModBus communication contact | |
| | (Ex9EMS 1P 2M 100A MB 2T & Ex9EMS 1P 2M 100A MO 2T only) | |
| 12/13 | External tariff input (Ex9EMS 1P 2M 100A 2T only) | |
| 18/19 | Pulse output contact (S0) forward | |
| 20/21 | Pulse output contact (S0) reverse | |

Ex9EMS 3P 4M - Direct connected - 3P 4W

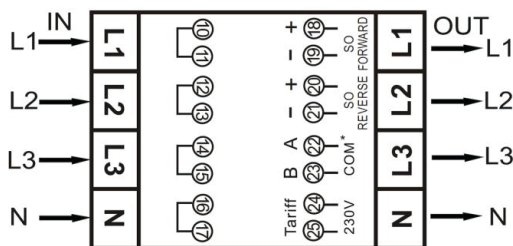

- | | |
|---------|---|
| L1 (in) | Phase 1 input - L1 (out) Phase 1 output |
| L2 (in) | Phase 2 input - L2 (out) Phase 2 output |
| L3 (in) | Phase 3 input - L3 (out) Phase 3 output |
| N (in) | Neutral input - N (out) neutral output |
| 10/11 | not used |
| 12/13 | not used |
| 14/15 | not used |
| 16/17 | not used |
| 18/19 | Forward pulse output contact (S0) |
| 20/21 | Reverse pulse output contact (S0) |
| 22/23 | M-Bus / ModBus communication contact |
| 24/25 | External tariff input (230V) |

Ex9EMS 3P 4M - Direct connected - 3P 3W Open Delta (Aron)

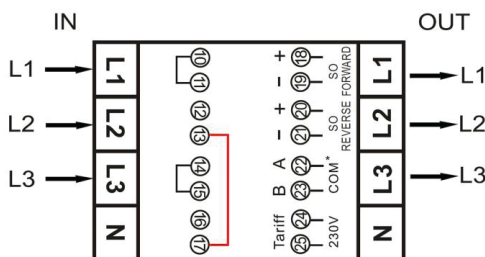

- | | |
|---------|---|
| L1 (in) | Phase 1 input - L1 (out) Phase 1 output |
| L2 (in) | Phase 2 input - L2 (out) Phase 2 output |
| L3 (in) | Phase 3 input - L3 (out) Phase 3 output |
| N (in) | not used - N (out) not used |
| 10/11 | not used |
| 12/13 | to be connected to 16/17 |
| 14/15 | not used |
| 16/17 | to be connected to 12/13 |
| 18/19 | Forward pulse output contact (S0) |
| 20/21 | Reverse pulse output contact (S0) |
| 22/23 | M-Bus / ModBus communication contact |
| 24/25 | External tariff input (230V) |

Technical Data Ex9EMS

Smart Energy Meters

Wiring diagrams

Ex9EMS 3P 4M - Direct connected - 3P 3W Delta

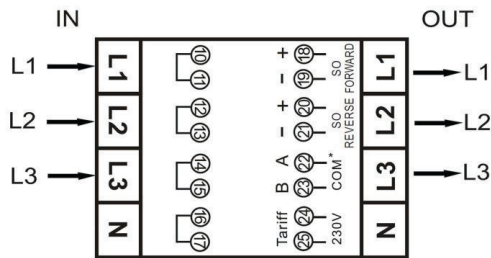

- L1 (in) Phase 1 input - L1 (out) Phase 1 output
- L2 (in) Phase 2 input - L2 (out) Phase 2 output
- L3 (in) Phase 3 input - L3 (out) Phase 3 output
- N (in) not used - N (out) not used
- 10/11 not used
- 12/13 not used
- 14/15 not used
- 16/17 not used
- 18/19 Forward pulse output contact (S0)
- 20/21 Reverse pulse output contact (S0)
- 22/23 M-Bus / ModBus communication contact
- 24/25 External tariff input (230V)

Ex9EMS 3P 4M - Direct connected - 1P 2W Single phase

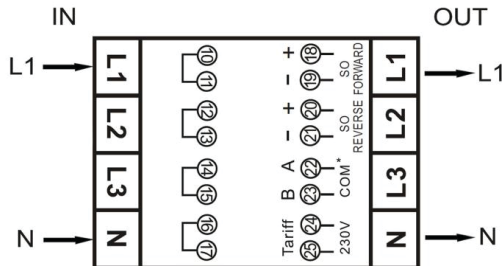

- L1 (in) Phase 1 input - L1 (out) Phase 1 output
- L2 (in) not used - L2 (out) not used
- L3 (in) not used - L3 (out) not used
- N (in) Neutral input - N (out) neutral output
- 10/11 not used
- 12/13 not used
- 14/15 not used
- 16/17 not used
- 18/19 Forward pulse output contact (S0)
- 20/21 Reverse pulse output contact (S0)
- 22/23 M-Bus / ModBus communication contact
- 24/25 External tariff input (230V)

Ex9EMS 3P 4M - CT - 3P 4W

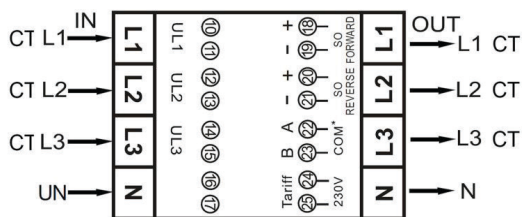

- CT1 (in) Phase 1 input - CT1 (out) Phase 1 output
- CT2 (in) Phase 2 input - CT2 (out) Phase 2 output
- CT3 (in) Phase 3 input - CT3 (out) Phase 3 output
- UN (in) Neutral input - UN (out) neutral output
- 10/11 Phase 1 - UL1
- 12/13 Phase 2 - UL2
- 14/15 Phase 3 - UL3
- 16/17 not used
- 18/19 Forward pulse output contact (S0)
- 20/21 Reverse pulse output contact (S0)
- 22/23 M-Bus / ModBus communication contact
- 24/25 External tariff input (230V)

Ex9EMS 3P 4M - CT - 3P 3W Open Delta (Aron)

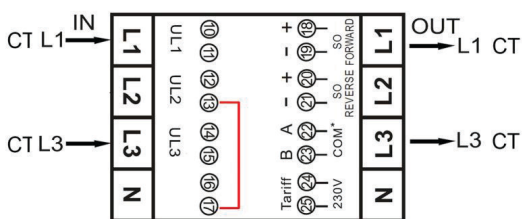

- CT1 (in) Phase 1 input - CT1 (out) Phase 1 output
- CT2 (in) not used - CT2 (out) not used
- CT3 (in) Phase 3 input - CT3 (out) Phase 3 output
- UN (in) not used - UN (out) not used
- 10/11 Phase 1 - UL1
- 12 Phase 2 - UL2
- 13 to be connected to 17
- 14/15 Phase 3 - UL3
- 17 to be connected to 13 (16 not used)
- 18/19 Forward pulse output contact (S0)
- 20/21 Reverse pulse output contact (S0)
- 22/23 M-Bus / ModBus communication contact
- 24/25 External tariff input (230V)

Ex9EMS 3P 4M - CT - 3P 3W Delta

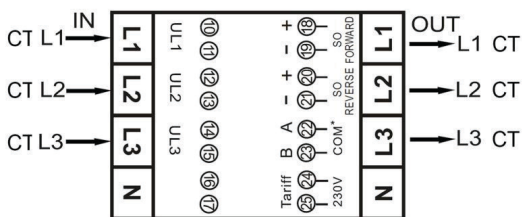

- CT1 (in) Phase 1 input - CT1 (out) Phase 1 output
- CT2 (in) Phase 2 input - CT2 (out) Phase 2 output
- CT3 (in) Phase 3 input - CT3 (out) Phase 3 output
- UN (in) not used - UN (out) not used
- 10/11 Phase 1 - UL1
- 12/13 Phase 2 - UL2
- 14/15 Phase 3 - UL3
- 16/17 not used
- 18/19 Forward pulse output contact (S0)
- 20/21 Reverse pulse output contact (S0)
- 22/23 M-Bus / ModBus communication contact
- 24/25 External tariff input (230V)

Technical Data Ex9EMS

Smart Energy Meters

Wiring diagrams

Ex9EMS 3P 4M - CT - 1P 2W - Single phase

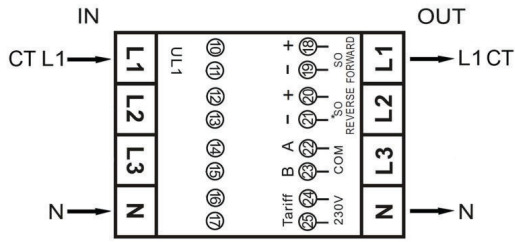

- CT1 (in) Phase 1 input - CT1 (out) Phase 1 output
- CT2 (in) not used - CT2 (out) not used
- CT3 (in) not used - CT3 (out) not used
- UN (in) Neutral input - UN (out) neutral output
- 10/11 Phase 1 - UL1
- 12/13 not used
- 14/15 not used
- 16/17 not used
- 18/19 Forward pulse output contact (S0)
- 20/21 Reverse pulse output contact (S0)
- 22/23 M-Bus / ModBus communication contact
- 24/25 External tariff input (230V)

Technical Data CT

Current transformers

General parameters

Primary current up to 1000A
Solid core or split core
Possibility of instalation into existing bushbars/cables

Electrical parameters

	CT Solid core	CT Split core
Max. rated voltage	660 V	660 V
Rated frequency f	50/60 Hz	50/60 Hz
Primary current	100 - 1 000 A	100 - 600 A
Secondary current	5 A	
Class	0.5	
Rated insulation voltage U _i	3 kV	2 kV
Burden	5/100 ... 2.5 VA 5/150 - 5/300 ... 5 VA 5/1000 ... 10 VA	5/100 - 5/300 ... 1.5 VA 5/400 - 5/600 ... 2 VA

Mechanical parameters

	CT Solid core	CT Split core
Device width		
5/100 - 5/300	34 mm	41 mm
5/400 - 5/600	40 mm	42 mm
5/1000	59 mm	-
Device height		
5/100 - 5/300	81 mm	66.5 mm
5/400 - 5/600	100 mm	84 mm
5/1000	121 mm	-
Device depth		
5/100 - 5/300	61 mm	50.5 mm
5/400 - 5/600	82 mm	57.5 mm
5/1000	125 mm	-
Terminals	screw terminals	integral 1m cable
Cable aperture		
5/100 - 5/300	23 mm	24 mm
5/400 - 5/600	37 mm	36 mm
5/1000	50 mm	-
Ambient temperature	-25°C — +40°C	-15°C — +40°C
Weight		
5/100 - 5/300	0.25 kg	0.25 kg
5/400 - 5/600	0.35 kg	0.42 kg
5/1000	0.59 kg	-

Technical Data CT

Current transformers

Dimensions

CT 5/100A SC
 CT 5/150A SC
 CT 5/200A SC
 CT 5/250A SC
 CT 5/300A SC

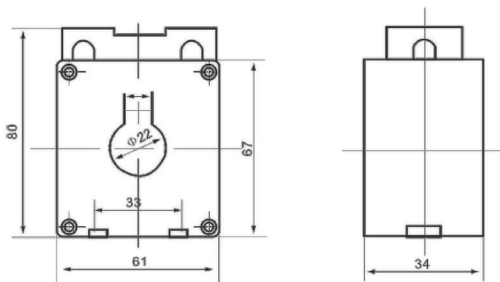

CT 5/100A
 CT 5/150A
 CT 5/200A
 CT 5/250A
 CT 5/300A

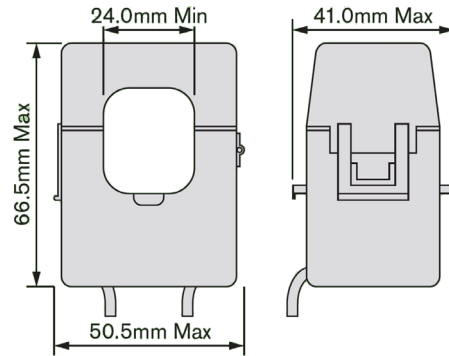

CT 5/400A SC
 CT 5/500A SC
 CT 5/600A SC

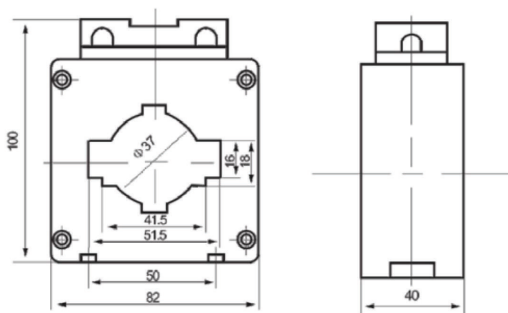

CT 5/400A
 CT 5/600A

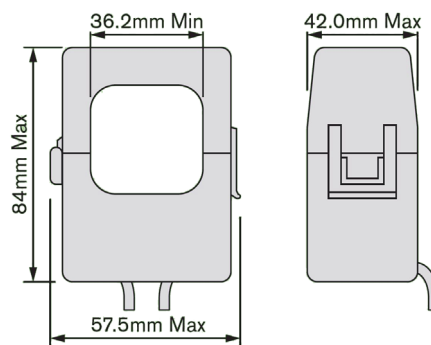

CT 5/1000A SC

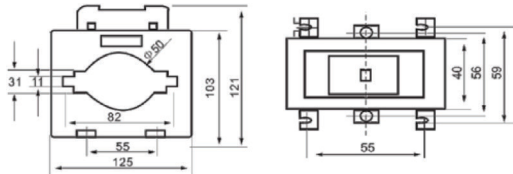

Technical Data CT

Current transformers

Wiring diagrams

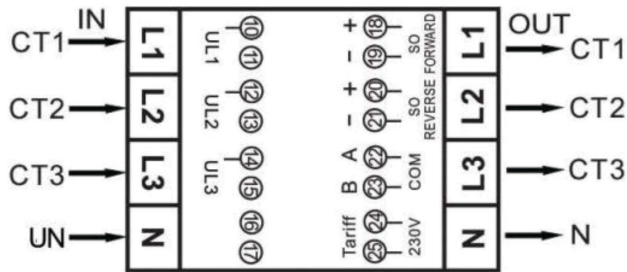

CT Solid core

S1 (on CT) to L1 IN (on the Meter)
S2 (on CT) to L1 OUT (on the Meter)

P1 (on CT) = IN
P2 (on CT) = OUT

CT Split core

Red cable to L1 IN
Black cable to L1 OUT

K (on CT) = IN
L (on CT) = OUT

Note: Be sure that the cables are in the right direction. If the CT is in the wrong way, then the meter will read in reverse.

Technical Data Ex9SN25B

Motor protective circuit breakers

General parameters

For protection of various motor applications

Provide overload, short-circuit and phase-failure protection

Can replace the circuit breaker and thermal relay to reduce costs and space

Temperature compensation function to reduce the impact of ambient temperature

Accessories

Front-mounted auxiliary contacts	ASNB	108954, 108955
Side-mounted auxiliary contacts	ASNA	108956, 108957
Alarm contacts	ASNF	108964, 108965, 108966, 108967
Undervoltage releases	ASNUV	108958, 108959, 108960
Shunt trip releases	ASNT	108961, 108962, 108963
Isolated boxes for surface mounting	ASNE	108968, 108969
Max. number of installed accessories are 2 pcs of contact or signal units (2 pcs ASNA or 1 pc of ASNA + 1 pc of ASNF) or 1 pc of front-mounted contact unit (ASNB) and 1 pc of voltage release (ASNT, ASNUV)		

Electrical parameters

Tested according to	EN 60947-4-1 EN 60947-2
Rated operating voltage U_e	230/240, 400/415, 440, 500, 690 V AC
Rated frequency f	50/60 Hz
Rated insulation voltage U_i	690 V
Rated impulse withstand voltage U_{imp}	8 kV
Rated current I_e	0.16 – 25 A
Fixed rated inst. short-circuit current I_i	see table below for exact values
Conventional free air thermal current I_{th}	$I_{th} = I_e$
Rated ultimate short-circuit breaking capacity I_{cu} (EN 60947-2)	
I_e 0.1 – 18 A at 230/240 V AC	100 kA
I_e 17 – 25 A at 230/240 V AC	50 kA
I_e 0.1 – 10 A at 400/415 V AC	100 kA
I_e 9 – 25 A at 400/415 V AC	15 kA
I_e 0.1 – 1.6 A at 660/690 V AC	100 kA
I_e 1.6 – 25 A at 660/690 V AC	3 kA
Rated service short-circuit breaking capacity I_{cs} (EN 60947-2)	
I_e 0.1 – 18 A at 230/240 V AC	100 kA
I_e 17 – 25 A at 230/240 V AC	50 kA
I_e 0.1 – 6.3 A at 400/415 V AC	100 kA
I_e 6 – 18 A at 400/415 V AC	7.5 kA
I_e 17 – 25 A at 400/415 V AC	6 kA
I_e 0.1 – 1.6 A at 660/690 V AC	100 kA
I_e 1.6 – 25 A at 660/690 V AC	2.25 kA
Required contactor type	
I_e 0.1 – 10 A	Ex9CS06/09 or Ex9C12 frame size
I_e 14 – 25 A	Ex9C18/25 frame size
Maximum operating frequency	30 operating cycles per hour
Electrical service life	2 000 operating cycles (at 400 V AC-3)
Power loss	9 W

Technical Data Ex9SN25B

Motor protective circuit breakers

Mechanical parameters

Device width	44.5 mm
Device height	91.3 mm
Device depth	81 mm
Frame size	45 mm
Mounting	easy fastening onto 35 mm device rail (DIN)
Safety arcing distance	40 mm
Degree of protection	IP20
Mechanical service life	10 000 operating cycles
Terminals	lift
Terminal capacity	1 – 6 mm ²
Fastening torque of terminals	1.7 Nm
Ambient temperature	-5 – +40 °C
Altitude	≤ 2 000 m
Relative humidity	≤ 50 %
Resistance to climatic conditions	class 2, according to EN 60068-2-3 and EN 60068-2-30
Resistance to mechanical shock	30 gn (shock duration 11 ms)
Resistance to vibrations	5 gn (5 – 150 Hz)
Pollution degree	3
Overvoltage class	III
Weight	0.33 kg

Dimensions

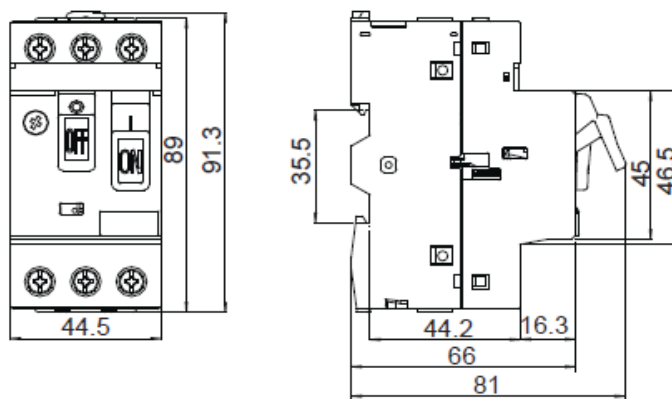

Mounting positions

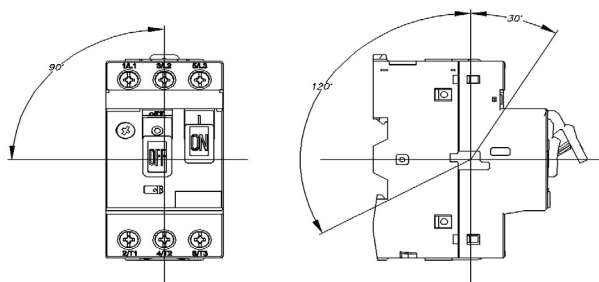

Technical Data Ex9SN25B

Motor protective circuit breakers Ex9SN25B

Rated instantaneous short-circuit current I_i

I_o [A]	0.16 A	0.25 A	0.40 A	0.63 A	1 A	1.6 A	2.5 A	4.0 A	6.3 A	10 A	14 A	18 A	23 A	25 A
I_i [A]	1.5	2.4	5	8	13	22.5	33.5	51	78	138	170	223	327	327

Rated power of three-phase motor

I_o [A]	AC-3, 50/60 Hz [W]					
	230/240 V	400 V	415 V	440 V	500 V	690 V
0.16 A	-	-	-	-	-	-
0.25 A	-	-	-	-	-	-
0.40 A	-	-	-	-	-	-
0.63 A	-	-	-	-	-	0.37
1 A	-	-	-	0.37	0.37	0.55
1.6 A	-	0.37	-	0.55	0.75	1.1
2.5 A	0.37	0.75	0.75	1.1	1.1	1.5
4.0 A	0.75	1.5	1.5	1.5	2.2	3.0
6.3 A	1.1	2.2	2.2	3.0	3.7	4.0
10 A	2.2	4.0	4.0	4.0	5.5	7.5
14 A	3.0	5.5	5.5	7.5	7.5	9
18 A	4.0	7.5	9	9	9	11
23 A	5.5	11	11	11	11	15
25 A	5.5	11	11	11	15	18.5

Maximum value of backup fuse for short-circuit protection for $I_{cc} > I_{cu}$

I_o [A]	230/240 V		400/415 V		440 V		500 V		690 V	
	aM A	gL/gG A	aM A	gL/gG A	aM A	gL/gG A	aM A	gL/gG A	aM A	gL/gG A
0.16 A	-	-	-	-	-	-	-	-	-	-
0.25 A	-	-	-	-	-	-	-	-	-	-
0.40 A	-	-	-	-	-	-	-	-	-	-
0.63 A	-	-	-	-	-	-	-	-	-	-
1 A	-	-	-	-	-	-	-	-	-	-
1.6 A	-	-	-	-	-	-	-	-	-	-
2.5 A	-	-	-	-	-	-	-	-	16	20
4.0 A	-	-	-	-	-	-	-	-	25	32
6.3 A	-	-	-	-	50	63	50	63	32	40
10 A	-	-	-	-	50	63	50	63	32	40
14 A	-	-	63	80	50	63	50	63	40	50
18 A	-	-	63	80	50	63	50	63	40	50
23 A	80	100	80	100	63	80	50	63	40	50
25 A	80	100	80	100	63	80	50	63	40	50

Technical Data Ex9SN25B

Motor protective circuit breakers Ex9SN25B

Tripping characteristics

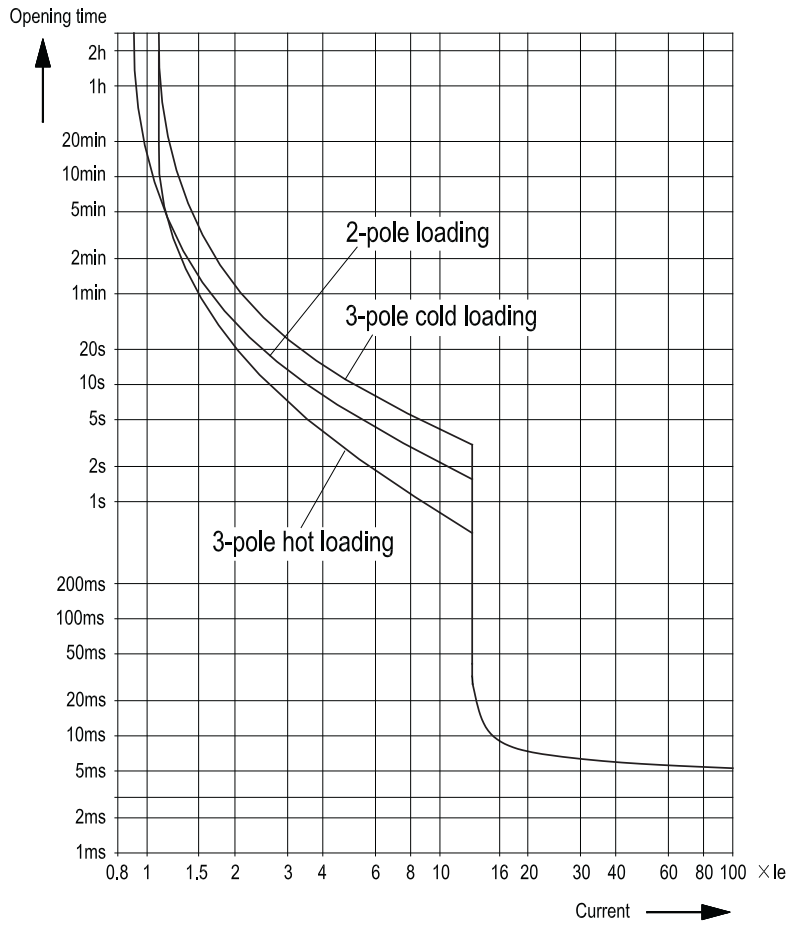

Connection diagram

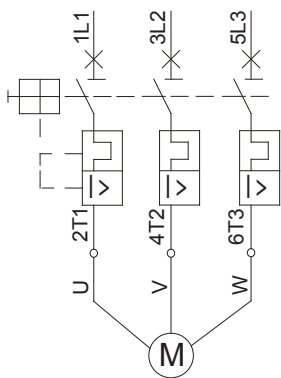

3-phase motor protection

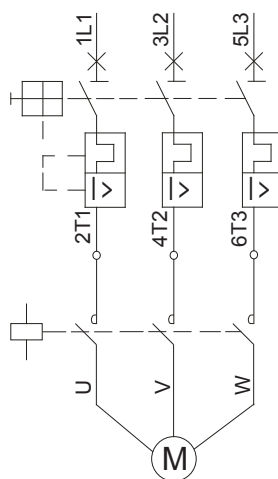

3-phase motor protection with contactor

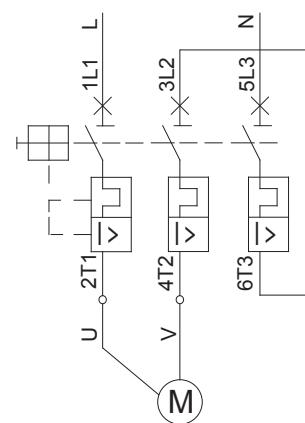

1-phase or DC motor protection

Technical Data Accessories

Accessories for Ex9B, Ex9PN, Ex9BI, Ex9IP devices

Auxiliary and signal contact units AX31, AL31, AXL31

General parameters

With one device, there can be used up to three contact units with single CO contact or up to two contact units with 2 CO
Contact units can be combined in an arbitrary way
Contact units are mounted to the device from the left
In case of installed release unit(s), contact modules are mounted left to the release(s)
Auxiliary contacts synchronous with main contacts of the device
Signal contacts active on electrical tripping of the circuit breaker (tripping signal contacts)

Electrical parameters

	AX3111	AX3122	AL3111	AXL31
Contacts	1 changeover (CO)	2 changeover (CO)	1 changeover (CO)	1 CO + 1 CO
Contact function	auxiliary	auxiliary	signal	auxiliary + signal
Tested according to	IEC/EN 60947-1, IEC/EN 60947-5-1			
Rated op. voltage	240/415 V AC, 24/48/130 V DC			
Min. op. voltage per contact U_{min}	24 V AC/DC			
Rated frequency	50/60 Hz			
Rated op. current I_e AC	6 A (240 V), 3 A (415 V)			
Rated op. current I_e DC	6 A (24 V), 2 A (48 V), 1 A (130 V)			
Rated thermal current I_{th}	6 A			
Rated op. current I_e , ut. cat. AC-12	6 A (240 V), 3 A (415 V)			
Rated op. current I_e , ut. cat. DC-12	6 A (24 V), 2 A (48 V), 1 A (130 V)			
Rated impulse withstand voltage U_{imp}	4 kV (1.2/50 μ s)			
Rated insulation voltage U_i	500 V			
Max. back-up fuse	10 A gG			
Conditional short circuit current I_k with max. back-up fuse	1 kA			

Mechanical parameters

	AX3111	AX3122	AL3111	AXL31
Tripping indicator	ON-OFF-RESET	ON-OFF-RESET	ON-OFF-RESET	ON-OFF-RESET
Device width	9 mm			
Device height	89 mm			
Frame size	45 mm			
Mounting	easy fastening onto 35 mm device rail (DIN)			
Degree of protection	IP20			
Terminals	lift			
Terminal capacity	1 — 6 mm ²			
Fastening torque of terminals	0.8 — 1 Nm			

Technical Data Accessories

Accessories for Ex9B, Ex9PN, Ex9BI, Ex9IP devices

Auxiliary and signal contact units AX31, AL31, AXL31

Dimensions

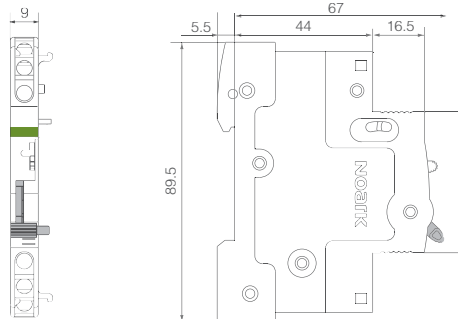

Wiring diagrams

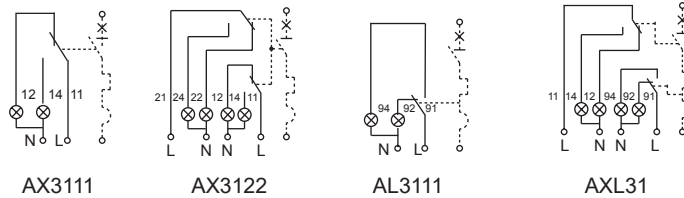

Technical Data Accessories

Accessories for Ex9B, Ex9PN, Ex9BI, Ex9IP devices

Shunt trip releases SHT31

General parameters

With one device, there can be used up to two units of release (shunt trip, undervoltage, overvoltage)
Release units can be combined in an arbitrary way
Release units are mounted to the device from the left
In case of installed contact module(s), release units are mounted left to the device, right to the contact unit(s)
Can be used for remote switch off

Electrical parameters

	SHT31 110V-415V AC/110V-130V DC SHT3111 110V-415V AC/110V-130V DC	SHT31 48V AC/DC SHT3111 48V AC/DC	SHT31 12-24V AC/DC SHT3111 12-24V AC/DC
Contacts	- 1 changeover (CO)	- 1 changeover (CO)	- 1 changeover (CO)
Contact function	auxiliary	auxiliary	auxiliary
Tested according to	IEC/EN 60947-1, IEC/EN 60947-5-1		
Rated operating voltage	110-415 V AC, 110-130 V DC	48 V AC/DC	12-24 V AC/DC
Rated frequency	50/60 Hz		
Rated impulse withstand voltage U_{imp}	4 kV (1.2/50 μ s)		
Rated insulation voltage	500 V		
Tripping time	< 10 ms	< 10 ms	< 10 ms
Min. duration of control pulse	8 ms	8 ms	8 ms
Max. back-up fuse	10 A gG	10 A gG	10 A gG
Min. op. voltage per AX contact U_{min}	24 V AC/DC		
Rated op. current I_e AC of AX contact	6 A (240 V), 3 A (415 V)		
Rated op. current I_e DC of AX contact	6 A (24 V), 2 A (48 V), 1 A (130 V)		
Rated thermal current I_{th} of AX cont.	6 A		
Rated op. current I_e AC-12 of AX	6 A (240 V), 3 A (415 V)		
Rated op. current I_e DC-12 of AX	6 A (24 V), 2 A (48 V), 1 A (130 V)		
Max. back-up fuse of AX	10 A gG		
Conditional short circuit current I_k with max. back-up fuse of AX	1 kA		

Mechanical parameters

	SHT31 110V-415V AC/110V-130V DC SHT3111 110V-415V AC/110V-130V DC	SHT31 48V AC/DC SHT3111 48V AC/DC	SHT31 12-24V AC/DC SHT3111 12-24V AC/DC
Tripping indicator	red-white	red-white	red-white
Device width	18 mm		
Device height	83 mm		
Frame size	45 mm		
Mounting	easy fastening onto 35 mm device rail (DIN)		
Degree of protection	IP20		
Terminals	lift		
Terminal capacity	1 — 6 mm ²		
Fastening torque of terminals	0.8 — 1 Nm		

Technical Data Accessories

Accessories for Ex9B, Ex9PN, Ex9BI, Ex9IP devices

Shunt trip releases SHT31

Dimensions

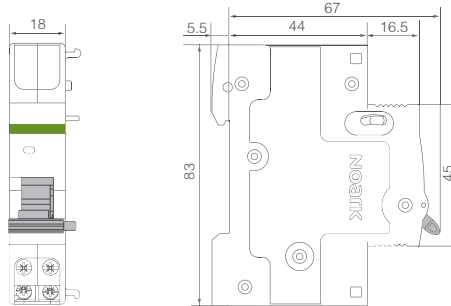

Wiring diagrams

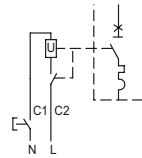

SHT31

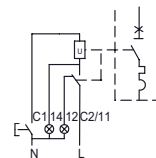

SHT3111

Technical Data Accessories

Accessories for Ex9B, Ex9PN, Ex9BI, Ex9IP devices

Undervoltage releases UVT31

General parameters

With one device, there can be used up to two units of release (shunt trip, undervoltage, overvoltage)
Release units can be combined in an arbitrary way
Release units are mounted to the device from the left
In case of installed contact module(s), release units are mounted left to the device, right to the contact unit(s)
To switch connected device off in case of voltage drop

Electrical parameters

	UVT31 220-240V AC UVT3101 220-240V AC UVT3110 220-240V AC	UVT31 48V AC/DC UVT3101 48V AC/DC UVT3110 48V AC/DC
Contacts	- 1 normally closed (NC) 1 normally open (NO)	- 1 normally closed (NC) 1 normally open (NO)
Contact function	auxiliary	auxiliary
Tested according to	IEC/EN 60947-1, IEC/EN 60947-5-1	
Rated operating voltage U_n	220-240 V AC	48 V AC/DC
Rated frequency	50/60 Hz	
Rated impulse withstand voltage U_{imp}	4 kV (1.2/50 μ s)	
Rated insulation voltage	500 V	
Tripping time	< 10 ms	< 10 ms
Making threshold	85 % U_n	85 % U_n
Tripping threshold	35 % U_n	35 % U_n
Min. op. voltage per AX contact U_{min}	24 V AC/DC	
Rated op. current I_e AC of AX contact	6 A (240 V), 3 A (415 V)	
Rated op. current I_e DC of AX contact	6 A (24 V), 2 A (48 V), 1 A (130 V)	
Rated thermal current I_{th} of AX cont.	6 A	
Rated op. current I_e AC-12 of AX	6 A (240 V), 3 A (415 V)	
Rated op. current I_e DC-12 of AX	6 A (24 V), 2 A (48 V), 1 A (130 V)	
Max. back-up fuse of AX	10 A gG/gL	
Conditional short circuit current I_k with max. back-up fuse of AX	1 kA	

Mechanical parameters

	UVT31 220-240V AC UVT3101 220-240V AC UVT3110 220-240V AC	UVT31 48V AC/DC UVT3101 48V AC/DC UVT3110 48V AC/DC
Tripping indicator	red-white	red-white
Device width	18 mm	
Device height	83 mm	
Frame size	45 mm	
Mounting	easy fastening onto 35 mm device rail (DIN)	
Degree of protection	IP20	
Terminals	lift	
Terminal capacity	1 — 6 mm ²	
Fastening torque of terminals	0.8 — 1 Nm	

Technical Data Accessories

Accessories for Ex9B, Ex9PN, Ex9BI, Ex9IP devices

Undervoltage releases UVT31

Dimensions

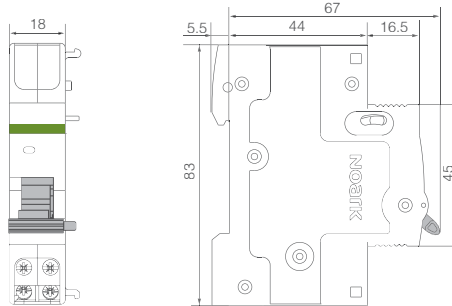

Wiring diagrams

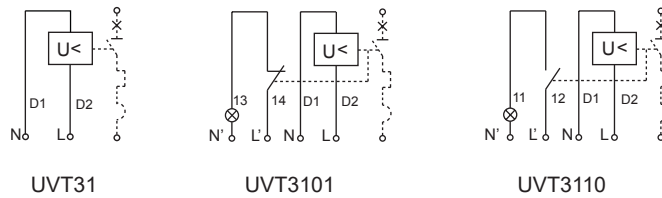

Technical Data Accessories

Accessories for Ex9B, Ex9PN, Ex9BI, Ex9IP devices

Overvoltage releases OVT31

General parameters

With one device, there can be used up to two units of release (shunt trip, undervoltage, overvoltage)
Release units can be combined in an arbitrary way
Release units are mounted to the device from the left
In case of installed contact module(s), release units are mounted left to the device, right to the contact unit(s)
Overvoltage release is not a protection against transient overvoltage and does not supersede surge protection devices
To switch connected device off in case of increased voltage

Electrical parameters

	OVT31 280V AC±5%
Contacts	-
Tested according to	IEC/EN 60947-1, IEC/EN 60947-5-1
Rated operating voltage U_n	280 V AC ±5 %
Rated frequency	50/60 Hz
Rated impulse withstand voltage U_{imp}	4 kV (1.2/50 µs)
Rated insulation voltage	500 V
Tripping time	< 1 s (290 V), < 0,1 s (380 V)

Mechanical parameters

	OVT31 280V AC±5%
Tripping indicator	red-white
Device width	18 mm
Device height	83 mm
Frame size	45 mm
Mounting	easy fastening onto 35 mm device rail (DIN)
Degree of protection	IP20
Terminals	lift
Terminal capacity	1 — 6 mm ²
Fastening torque of terminals	0.8 — 1 Nm

Technical Data Accessories

Accessories for Ex9B, Ex9PN, Ex9BI, Ex9IP devices

Overvoltage releases OVT31

Dimensions

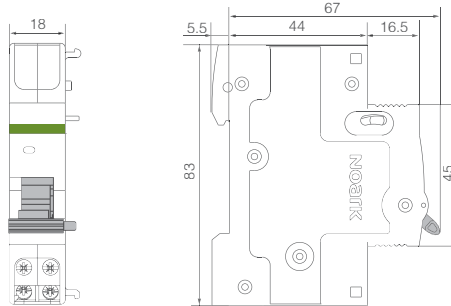

Wiring diagram

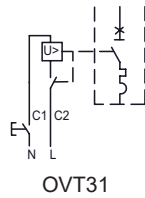

OVT31

Technical Data Ex9SN25B Accessories

Accessories for motor protective circuit breakers Ex9SN25B

Front-mounted auxiliary contact unit ASNB

General parameters

For subsequent mounting

Front-mounted version

1 unit can be used with a motor protective circuit breaker

Electrical parameters

	ASNB20	ASNB11
Contacts	2 NO	1 NO + 1 NC
Tested according to	EN 60947-5-1	
Rated operating voltage U_e	240V AC, 415V AC, 220V DC	
Rated frequency	50/60 Hz	
Rated thermal current I_{th}	2.5 A	
Rated op. current I_e , ut. cat. AC-15	0.5 A at 240 V	
Rated op. current I_e , ut. cat. DC-13	0.15 A at 60 V	
Rated impulse withstand voltage U_{imp}	2.5 kV	
Rated insulation voltage U_i	250 V	

Mechanical parameters

	ASNB20	ASNB11
Device width	45 mm	
Device height	9.5 mm	
Device depth	28.7 mm	
Mounting	front	
Degree of protection	IP20	
Terminals	lift	
Terminal capacity	1 – 2.5 mm ²	
Fastening torque of terminals	0.8 Nm	

Wiring diagram

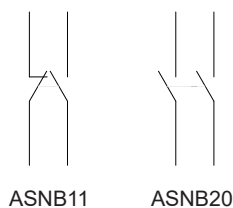

Technical Data Ex9SN25B Accessories

Accessories for motor protective circuit breakers Ex9SN25B

Side-mounted auxiliary contact unit ASNA

General parameters

For subsequent mounting

Side-mounted version, mounting from the left

Up to 2 units can be used with a motor protective circuit breaker

Electrical parameters

	ASNA20	ASNA11
Contacts	2 NO	1 NO + 1 NC
Tested according to	EN 60947-5-1	
Rated operating voltage U_e	240 V AC, 415 V AC, 220 V DC	
Rated frequency f	50/60 Hz	
Rated thermal current I_{th}	6 A	
Rated op. current I_e , ut. cat. AC-15	3.3 A at 240 V, 1.5 A at 415 V	
Rated op. current I_e , ut. cat. DC-13	3 A at 60 V	
Rated impulse withstand voltage U_{imp}	4 kV	
Rated insulation voltage U_i	690 V	

Mechanical parameters

	ASNA20	ASNA11
Device width	9.5 mm	
Device height	91.3 mm	
Device depth	65.6 mm	
Mounting	left side	
Degree of protection	IP20	
Terminals	lift	
Terminal capacity	1 – 2.5 mm ²	
Fastening torque of terminals	0.8 Nm	

Wiring diagram

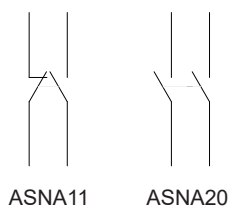

Technical Data Ex9SN25B Accessories

Accessories for motor protective circuit breakers Ex9SN25B

Front-mounted auxiliary contact unit ASNF

General parameters

For subsequent mounting
Front-mounted version
1 unit can be used with a motor protective circuit breaker

Electrical parameters

	ASNF1001	ASNF0101	ASNF1010	ASNF0110
Contacts	1 NO (Fault) + 1 NC (Aux)	1 NC (Fault) + 1 NC (Aux)	1 NO (Fault) + 1 NO (Aux)	1 NC (Fault) + 1 NO (Aux)
Tested according to	EN 60947-5-1			
Rated operating voltage U_e	Fault: 240 V AC, Auxiliary: 690 V AC			
Rated frequency	50/60 Hz			
Rated thermal current I_{th}	Fault: 2.5 A, Auxiliary: 6 A			
Rated op. current I_e , ut. cat. AC-14	Fault: 0.3 A at 240 V			
Rated op. current I_e , ut. cat. DC-13	Fault: 0.15 A at 60 V			
Rated impulse withstand voltage U_{imp}	4 kV			
Rated insulation voltage U_i	690 V			

Mechanical parameters

	ASNF1001	ASNF0101	ASNF1010	ASNF0110
Device width	9.5 mm			
Device height	91.3 mm			
Device depth	65.5 mm			
Mounting	left side			
Degree of protection	IP20			
Terminals	lift			
Terminal capacity	1 – 2.5 mm ²			
Fastening torque of terminals	0.8 Nm			

Wiring diagram

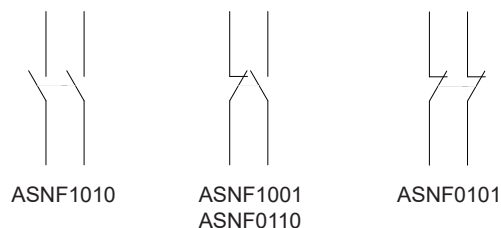

Technical Data Ex9SN25B Accessories

Accessories for motor protective circuit breakers Ex9SN25B

Shunt trip releases ASNT

General parameters

For subsequent mounting

Side-mounted version, mounting from the right

1 unit can be used with a motor protective circuit breaker or ASNUV unit

Electrical parameters

	ASNTA	ASNTB	ASNTC
Tested according to	EN 60947-2		
Rated operating voltage U_e	110 – 115 V AC @ 50 Hz 127 V AC @ 60 Hz	220 – 240 V AC @ 50 Hz	380 – 400 V AC @ 50 Hz 440 V AC @ 60 Hz
Oper. voltage tripping tolerance	70 – 110 % U_e		
Rated frequency f	50/60 Hz		
Rated impulse withstand voltage U_{imp}	6 kV		
Rated insulation voltage U_i	690 V		

Mechanical parameters

	ASNTA	ASNTB	ASNTC
Device width	18.5 mm		
Device height	91.3 mm		
Device depth	65.5 mm		
Mounting	right side		
Degree of protection	IP20		
Terminals	lift		
Terminal capacity	1 – 2.5 mm ²		
Fastening torque of terminals	0.8 Nm		

Wiring diagram

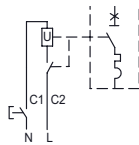

Technical Data Ex9SN25B Accessories

Accessories for motor protective circuit breakers Ex9SN25B

Undervoltage releases ASNUV

General parameters

For subsequent mounting

Side-mounted version, mounting from the right

1 unit can be used with a motor protective circuit breaker or ASNT unit

Electrical parameters

	ASNUVA	ASNUVB	ASNUVC
Tested according to	EN 60947-2		
Rated operating voltage U_e	110 – 115 V AC @ 50 Hz 127 V AC @ 60 Hz	220 – 240 V AC @ 50 Hz	380 – 400 V AC @ 50 Hz 440 V AC @ 60 Hz
Oper. voltage tripping tolerance	35 – 70 % U_e		
Rated frequency f	50/60 Hz		
Rated impulse withstand voltage U_{imp}	6 kV		
Rated insulation voltage U_i	690 V		
Tripping time	200 ms		
Making threshold	85 – 110 % U_e		

Mechanical parameters

	ASNUVA	ASNUVB	ASNUVC
Device width	18.5 mm		
Device height	91.3 mm		
Device depth	65.5 mm		
Mounting	right side		
Degree of protection	IP20		
Terminals	lift		
Terminal capacity	1 – 2.5 mm ²		
Fastening torque of terminals	0.8 Nm		

Wiring diagram

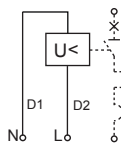

Technical Data Ex9SN25B Accessories

Accessories for motor protective circuit breakers Ex9SN25B

Isolated boxes for surface mounting ASNE

General parameters

Plastic IP55 boxes for single Ex9SN25B device.

Insulated boxes for surface mounting.

Electrical parameters

	ASNEA	ASNEB
Tested according to		EN 62208
Rated operating voltage U_e		400 V AC
Rated frequency f		50 Hz

Mechanical parameters

	ASNEA	ASNEB
Device width		93 mm
Device height		148 mm
Device depth	94 mm	152 mm
Mounting		surface
Degree of protection		IP55

Dimensions

ANSEA

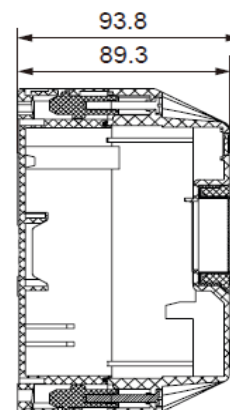
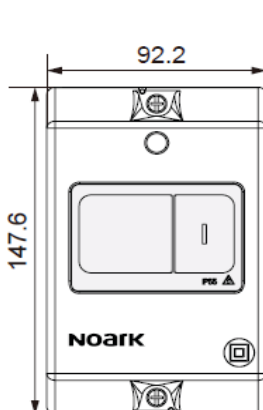
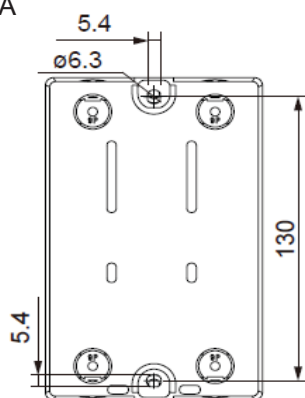

ANSEB

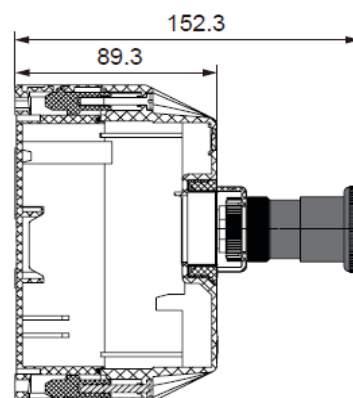
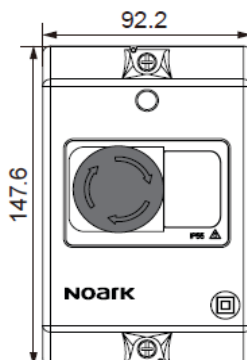
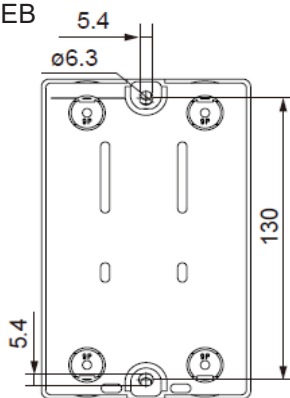

Technical Data Accessories

Accessories for Ex9NL-N and Ex9NLE

Auxiliary and signal contact units AXC31, AXLC31

General parameters

With one device, there can be used up to three contact units
Contact units can be combined in an arbitrary way
Contact units are mounted to the device from the left
In case of installed release unit(s), contact modules are mounted left to the release(s)
Auxiliary contacts synchronous with main contacts of the device
Signal contacts active on electrical tripping of the circuit breaker (tripping signal contacts)

Electrical parameters

	AXC31 11	AXLC31 11
Contacts	1 CO	1 CO
Contact function	auxiliary	signal
Tested according to	IEC/EN 60947-1, IEC/EN 60947-5-1	
Rated op. voltage	240/415 V AC, 24/48/130 V DC	
Min. op. voltage per contact U_{min}	24 V AC/DC	
Rated frequency	50/60 Hz	
Rated op. current I_e AC	6 A (240 V), 3 A (415 V)	
Rated op. current I_e DC	6 A (24 V), 2 A (48 V), 1 A (130 V)	
Rated thermal current I_{th}	6 A	
Rated op. current I_e , ut. cat. AC-12	6 A (240 V), 3 A (415 V)	
Rated op. current I_e , ut. cat. DC-12	6 A (24 V), 2 A (48 V), 1 A (130 V)	
Rated impulse withstand voltage U_{imp}	4 kV (1.2/50 μ s)	
Rated insulation voltage U_i	500 V	
Max. back-up fuse	10 A gG	
Conditional short circuit current I_k with max. back-up fuse	1 kA	

Mechanical parameters

	AXC31 11	AXLC31 11
Tripping indicator	ON-OFF-RESET	ON-OFF-RESET
Device width	9 mm	
Device height	89 mm	
Frame size	45 mm	
Mounting	easy fastening onto 35 mm device rail (DIN)	
Degree of protection	IP20	
Terminals	lift	
Terminal capacity	1 — 6 mm ²	
Fastening torque of terminals	0.8 — 1 Nm	

Technical Data Accessories

Accessories for RCBOs Ex9NL-N and Ex9NLE

Shunt trip releases SHTC31

General parameters

With one RCBO can be used up to two release units (shunt trip or undervoltage), they can be combined in an arbitrary way

Releases are mounted to the device from the left side

SHTC31 can be used for remote switch off function

Electrical parameters

	SHTC31 230/400V AC	SHTC31 24V AC/DC	SHTC31 48V AC/DC
Tested according to	IEC/EN 60947-5		
Rated operating voltage U_n	230/400 V AC	24 V AC/DC	48 V AC/DC
Operating voltage range	70 - 110% U_n		
Rated frequency	50/60 Hz		
Rated impulse withstand voltage U_{imp}	4 kV (1.2/50 μ s)		
Rated insulation voltage	500 V		
Tripping time	< 10 ms		
Min. duration of control pulse	8 ms		
Max. back-up fuse	10 A gG		
Electrical service life	4 000 operating cycles		
Rated op. current I_e AC of AX contact	6 A (240 V), 3 A (415 V)		
Rated op. current I_e DC of AX contact	6 A (24 V), 2 A (48 V)		
Rated thermal current I_{th} of AX cont.	6 A		
Rated op. current I_e AC-12 of AX	6 A (240 V), 3 A (415 V)		
Rated op. current I_e DC-12 of AX	6 A (24 V), 2 A (48 V)		
Max. back-up fuse of AX	10 A gG		
Conditional short circuit current I_k with max. back-up fuse of AX	1 kA		

Mechanical parameters

	SHTC31 230/400V AC	SHTC31 24V AC/DC	SHTC31 48V AC/DC
Tripping indicator	red-white	red-white	red-white
Device width	18 mm		
Device height	83 mm		
Frame size	45 mm		
Mounting	easy fastening onto 35 mm device rail (DIN)		
Degree of protection	IP20		
Mechanical service life	4 000 operating cycles		
Terminals	lift		
Terminal capacity	2.5 mm ²		
Fastening torque of terminals	0.8 Nm		
Ambient temperature	-5 — +40 °C		
Storage temperature	-25 — +70 °C		
Pollution degree	2		

Technical Data Accessories

Accessories for RCBOs Ex9NL-N and Ex9NLE

Shunt trip releases SHTC31

Dimensions

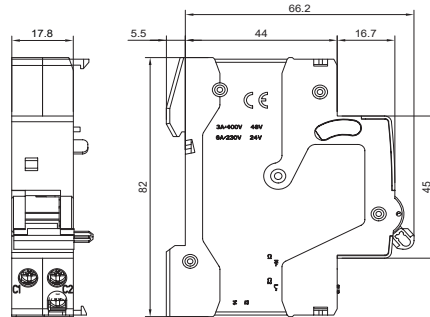

Wiring diagram

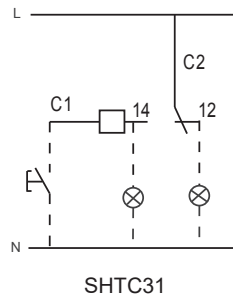

Technical Data Accessories

Accessories for RCBOs Ex9NL-N and Ex9NLE

Undervoltage release UVTC31

General parameters

With one RCBO can be used up to two release units (shunt trip or undervoltage), they can be combined in an arbitrary way

Release units are mounted to the RCBO from the left side

To switch connected device off in case of voltage drop

Electrical parameters

	UVTC31 230V AC
Tested according to	IEC/EN 60947-5
Rated operating voltage U_n	230 V AC
Rated frequency	50/60 Hz
Rated impulse withstand voltage U_{imp}	4 kV (1.2/50 μ s)
Rated insulation voltage	500 V
Tripping time	< 10 ms
Making threshold	85 % U_n
Tripping threshold	35 % U_n
Electrical service life	4 000 operating cycles

Mechanical parameters

	UVTC31 230V AC
Tripping indicator	red-white
Device width	18 mm
Device height	83 mm
Frame size	45 mm
Mounting	easy fastening onto 35 mm device rail (DIN)
Degree of protection	IP20
Mechanical service life	4 000 operating cycles
Terminals	lift
Terminal capacity	2.5 mm ²
Fastening torque of terminals	0.8 Nm
Ambient temperature	-5 — +40 °C
Storage temperature	-25 — +70 °C
Pollution degree	2

Technical Data Accessories

Accessories for RCBOs Ex9NL-N and Ex9NLE

Undervoltage releases UVTC31

Dimensions

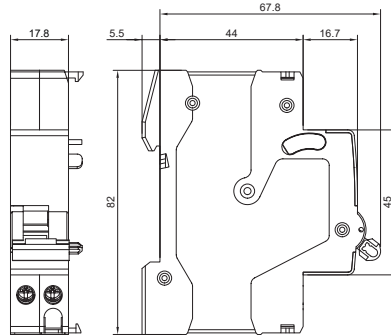

Wiring diagrams

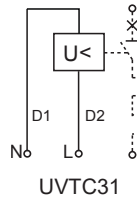

Technical Data Ex9UE1+2

Surge Protection Devices Type 1+2, $I_{imp} = 25 \text{ kA}$ (10/350 μs)

General parameters

Suitable for protection of electrical installations against transient overvoltage caused by direct and indirect lightning strokes or switching processes

Plug-in module design

Indication window and optional remote-signaling contact help users to know the status of device

Due to I_{imp} 25 kA per module suitable for LPL I - IV according to EN 62305 in standard 3-phase TN-C and TN-S installations

Electrical parameters

	3+0, 4+0, 3+1 (L-N/PE/PEN connection)	3+1 (+1 N-PE connection)
Tested according to	EN 61643-11	
Classified type (test class)	Type 1+2 (Class I+II, B+C, T1+T2)	
Technology	MOV+GTD (Varistor+Spark-gap)	GDT (Spark-gap)
Rated operational voltage U_n	230 / 400 V AC	
Reference test voltage U_{REF}	255 V AC	
Rated load current I_L	125 A	
Max. continuous operational voltage U_c	280 V AC	255 V AC
Nominal frequency f	50/60 Hz	
Nominal discharge current I_n (8/20 μs)	25 kA per pole	100 kA per pole
Max. impulse current I_{imp} (10/350 μs)	25 kA per pole	100 kA per pole
Impulse current specific energy W/R	156 kJ/ Ω	2500 kJ/ Ω
Max discharge current I_{max} (8/20 μs)	60 kA per pole	60 kA per pole, 100 kA NPE
Protection voltage U_p at I_n	1.5 kV	1.5 kV
Protection voltage U_p at I_{max}	2.0 kV	-
Protection voltage U_p at 5 kA (8/20 μs)	< 1.3 kV	-
Follow current interrupting rating I_n	-	100 A
Temporary overvoltage U_T (withstand)		
5 s	335 V	1200 V
200 ms	335 V	-
Residual current I_{PE} at U_{REF}	$\leq 1 \text{ mA}$	-
Response time	$\leq 100 \text{ ns}$	$\leq 100 \text{ ns}$
Max. back-up fuse	315 A gG	-
Short-circuit current rating I_{SCCR}	10 kA	-
Short-circuit withstand capability	25 kA	-
Current factor k	1.6	-
Number of ports	1	
Type of LV system	TN-C, TN-S, TN-C-S, TT (3+1)	
Remote contact (optional)	1 changeover (CO)	
Remote contact op. voltage / current		
AC U_{max} / I_{max}	250 V AC / 1 A	
DC U_{max} / I_{max}	30 V DC / 1 A	

Technical Data Ex9UE1+2

Surge Protection Devices Type 1+2, $I_{imp} = 25 \text{ kA} (10/350 \mu\text{s})$

Mechanical parameters

Device width	36 mm (per pole/module)
Device height	83 mm (89 mm including rail clip)
Frame size	45 mm
Method of mounting	fixed
Mounting	easy fastening onto 35 mm device rail (DIN)
Mounting position	arbitrary
Degree of protection	IP40, terminals IP20
Terminals	lift, M5 screws
Terminal capacity	10 — 50 mm ²
Fastening torque of terminals	2.5 — 3.5 Nm
Remote contact terminal capacity	0.14 — 1.5 mm ²
Location	indoor
Ambient temperature	-40 — +80 °C
Altitude	≤ 2000 m
Relative humidity	30 — 90 %
Weight (3P / 3P+N / 4P)	0.78 / 1.00 / 1.08 kg

Dimensions

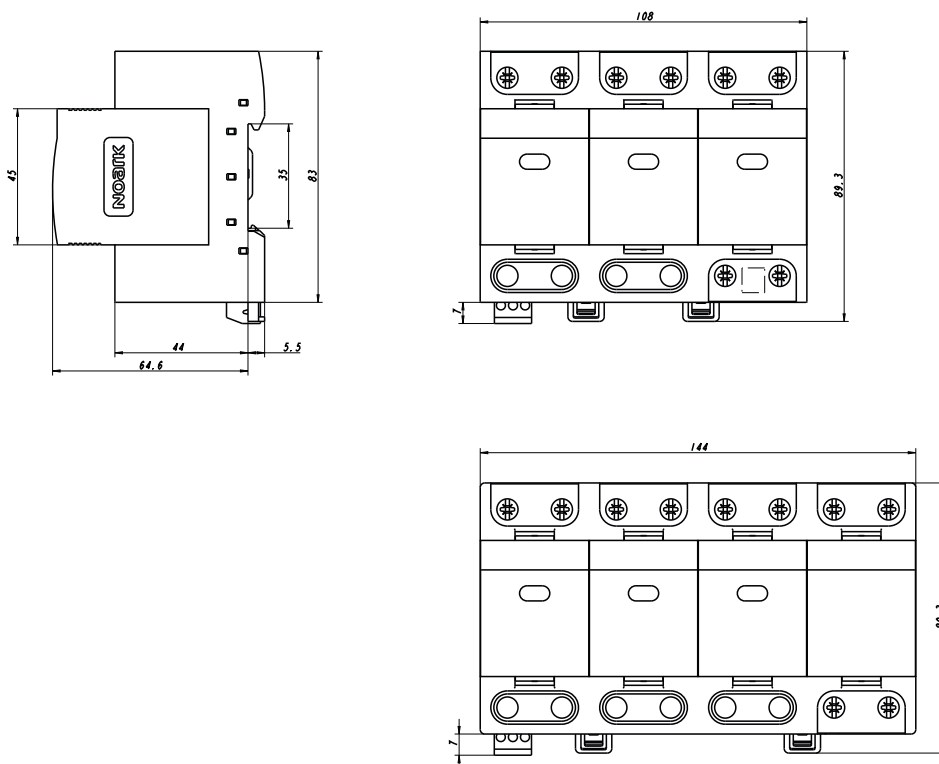

Technical Data Ex9UE1+2

Surge Protection Devices Type 1+2, $I_{imp} = 25 \text{ kA} (10/350 \mu\text{s})$

Connection diagrams, protection mode

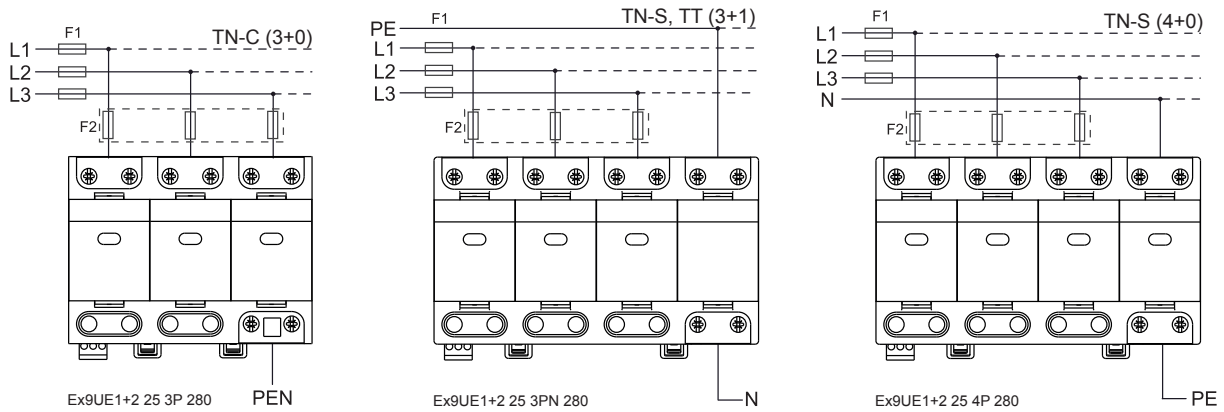

Technical Data Ex9UE1+2

Surge Protection Devices Type 1+2, $I_{imp} = 12.5 \text{ kA (10/350 } \mu\text{s)}$

General parameters

Suitable for protection of electrical installations against transient overvoltage and indirect lightning strikes
Plug-in module design
Indication window and optional remote-signaling contact helps users to know the status of device
Due to I_{imp} 12.5 kA per module suitable for LPL III and LPL IV according to EN 62305 in standard 3-phase TN-C and TN-S installations

Electrical parameters

	1+0, 2+0, 3+0, 4+0, 1+1, 3+1 (L-N/PE/PEN connection)	1+1, 3+1 (x+1 N-PE connection)
Tested according to	EN 61643-11	
Classified type (test class)	Type 1+2 (Class I+II, B+C, T1+T2)	
Technology	MOV (Varistor)	GDT (Spark-gap)
Rated operational voltage U_n	230 / 400 V AC	
Reference test voltage U_{REF}	255 V AC	
Max. continuous operational voltage U_c	275 V AC	255 V AC
Nominal frequency f	50/60 Hz	
Nominal discharge current I_n (8/20 μs)	25 kA per pole	50 kA per pole
Impulse current specific energy W/R	156.25 kJ/ Ω	
Max. impulse current I_{imp} (10/350 μs)	12.5 kA per pole	50 kA per pole
Max. discharge current I_{max} (8/20 μs)	50 kA per module	
Protection voltage U_p at I_n	1.5 kV	1.5 kV
Protection voltage U_p at I_{max}	1.8 kV	1.5 kV
Protection voltage U_p at 5 kA (8/20 μs)	1 kV	-
N-PE follow current interrupting rating I_n	-	100 A
Temporary overvoltage U_T (withstand)		
5 s	335 V	335 V
200 ms	335 V	1200 V
Residual current I_{PE} at U_{REF}	$\leq 1 \text{ mA}$	-
MOV voltage of 1mA point	387 - 473 V	
Response time	$\leq 25 \text{ ns}$	$\leq 100 \text{ ns}$
Max. back-up fuse	max. 160 A gG	-
Short-circuit withstand capability	50 kA	-
Short-circuit current rating I_{SCCR}	10 kA	-
Current factor k	1.6	-
Number of ports	1	
Type of LV system	TN-C, TN-S, TN-C-S, TT (1+1, 3+1), IT (1+1, 3+1)	
Remote contact (optional)	1 changeover (CO)	
Remote contact op. voltage / current		
AC U_{max} / I_{max}	250 V AC / 1 A	
DC U_{max} / I_{max}	30 V DC / 1 A	

Technical Data Ex9UE1+2

Surge Protection Devices Type 1+2, $I_{imp} = 12.5 \text{ kA (10/350 } \mu\text{s)}$

Mechanical parameters

Device width	17.5 mm (per pole/module)
Device height	83 mm (89 mm including rail clip)
Frame size	45 mm
Method of mounting	fixed
Mounting	easy fastening onto 35 mm device rail (DIN)
Mounting position	arbitrary
Degree of protection	IP40, terminals IP20
Terminals	combined lift + open mouthed, M5 screws
Terminal capacity	2.5 — 35 mm ²
Fastening torque of terminals	2 — 3.5 Nm
Remote contact terminal capacity	0.14 — 1.5 mm ²
Location	indoor
Ambient temperature	-40 — +80 °C
Altitude	≤ 2000 m
Relative humidity	30 — 90 %
Weight (per pole)	0.15 kg

Dimensions

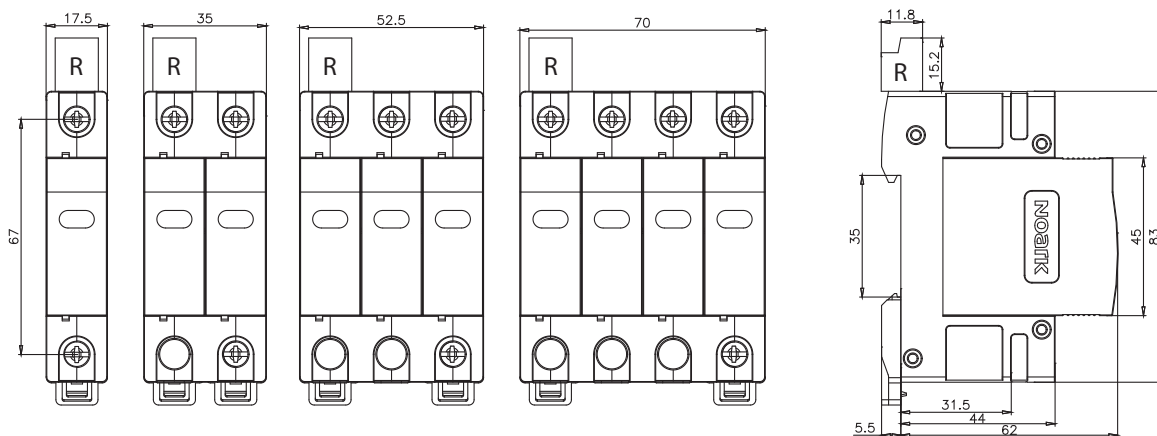

Technical Data Ex9UE1+2

Surge Protection Devices Type 1+2, $I_{imp} = 12.5 \text{ kA (10/350 } \mu\text{s)}$

Connection diagrams, protection mode

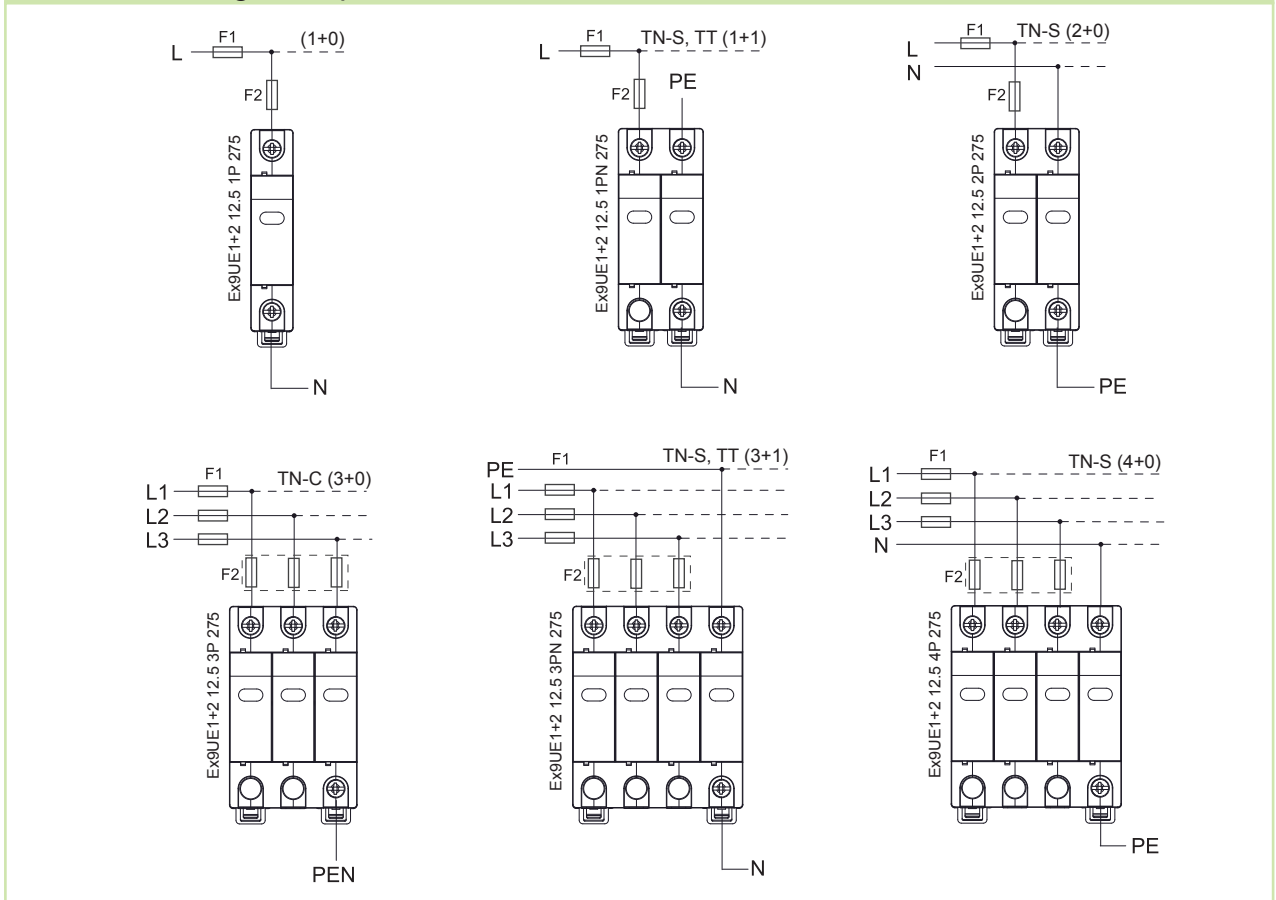

Surge Protection Devices Type 1+2 and Type 2

Wiring diagrams

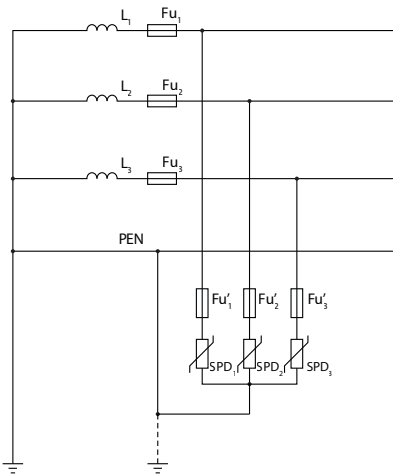

3+0 TN-C

Connection type 3+0 in TN-C system consists of three identical SPDs.

Fu_1 - Fu_3 represent main protection (fuses, circuit breaker) in the installation. In case when $Fu_1, Fu_2, Fu_3 > \text{Max. back-up fuse for given SPDs}$, Fu'_1, Fu'_2, Fu'_3 have to be used. $Fu'_1, Fu'_2, Fu'_3 \leq \text{Max. back-up fuse of the SPDs}$.

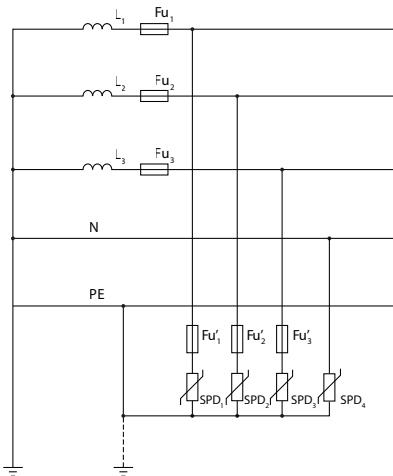

4+0 TN-S

Connection type 4+0 in TN-S system consists of four identical SPDs. This type of connection is suitable mainly to suppress longitudinal type of transient overvoltage, typically caused by atmospheric stroke. The advantages lay in uniform conducting of lightning current from phase and N-conductors. It also effectively protects insulation of conductors suffered with consecutive effects of a lightning stroke. This connection does not provide optimum protection in case transversal overvoltage (typically caused by wanted and unwanted fast switching processes) and thus it is not the best solution for protection of equipment and end consumers. It follows from the fact that residual transversal overvoltage between L and N conductors is given by protection level of two SPDs connected in a series. (e.g. Up of $SPD_1 + SPD_4$ for L_1 -N

Fu_1 - Fu_3 represent main protection (fuses, circuit breaker) in the installation. In case when $Fu_1, Fu_2, Fu_3 > \text{Max. back-up fuse for given SPDs}$, Fu'_1, Fu'_2, Fu'_3 have to be used. $Fu'_1, Fu'_2, Fu'_3 \leq \text{Max. back-up fuse of the SPDs}$.

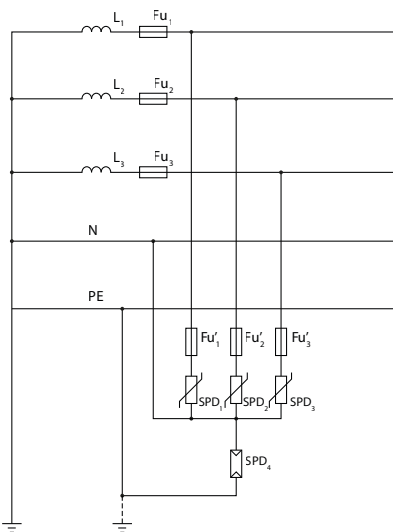

3+1 TN-S

Connection type 3+1 in TN-S system consists of three identical SPDs and one sum spark gap. It is suitable mainly to suppress transversal type of transient overvoltage, typically caused by wanted and unwanted fast switching processes. Main advantage is minimization of residual transversal overvoltage between L and N, which is defined dominantly by protection level of a single SPD. This diagram is recommended for protection of end consumers in TN-S system. A disadvantage for suppression of atmospheric longitudinal overvoltage follows from non-uniform protection of L and N conductors. When used for protection against longitudinal effects, usually as a protection against lightning stroke current (SPD class I), I_{imp} of sum spark gap SPD_4 must be min. $4 \times I_{imp}$ of SPD_1, SPD_2, SPD_3 .

Fu_1 - Fu_3 represent main protection (fuses, circuit breaker) in the installation. In case when $Fu_1, Fu_2, Fu_3 > \text{Max. back-up fuse for given SPDs}$, Fu'_1, Fu'_2, Fu'_3 have to be used. $Fu'_1, Fu'_2, Fu'_3 \leq \text{Max. back-up fuse of the SPDs}$.

Surge Protection Devices Type 1+2 and Type 2

Wiring diagrams

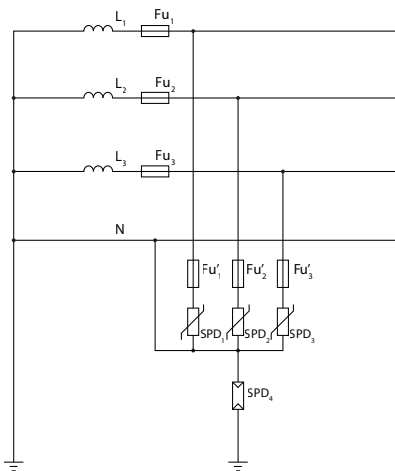

3+1 TT

In order to keep insulation status between N conductor and ground potential, connection 3+1 is recommended for TT systems. It provides maximum protection against transversal transient overvoltage and significantly limits longitudinal one.

Fu_1 - Fu_3 represent main protection (fuses, circuit breaker) in the installation. In case when $Fu_1, Fu_2, Fu_3 > \text{Max. back-up fuse for given SPDs}$, Fu'_1, Fu'_2, Fu'_3 have to be used. $Fu'_1, Fu'_2, Fu'_3 \leq \text{Max. back-up fuse of the SPDs}$.

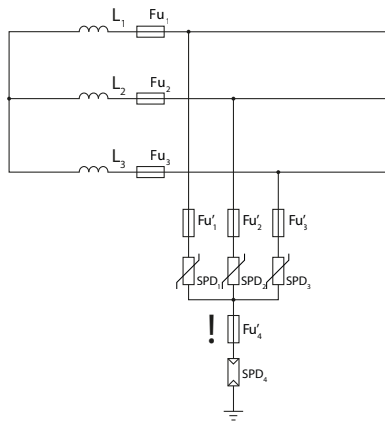

3+1 IT

3+1 connection in IT system is suitable for protection against both transversal as well as longitudinal overvoltage. Due to grounded sum spark gap allows effective reduction of effects caused by lightning currents. Particular SPDs are dimensioned to "phase" voltage of the system (i.e. to 230 V in 230/400V grid). An important difference to 3+1 connection in TN-S system is back up fuse for sum spark gap. This protection has to be used in IT systems. It ensures insulation status in case of spark gap malfunction like uninterrupted follow currents.

Fu_1 - Fu_3 represent main protection (fuses, circuit breaker) in the installation. In case when $Fu_1, Fu_2, Fu_3 > \text{Max. back-up fuse for given SPDs}$, Fu'_1, Fu'_2, Fu'_3 have to be used. $Fu'_1, Fu'_2, Fu'_3 \leq \text{Max. back-up fuse of the SPDs}$. $Fu'_4 \leq \text{Max. back up fuse of the sum spark gap SPD}_4$.

Note: Connection diagram is indicative only. There have to be observed and fulfill potential other requirements, e.g. insulation tests of sum spark gap etc., in actual IT system.

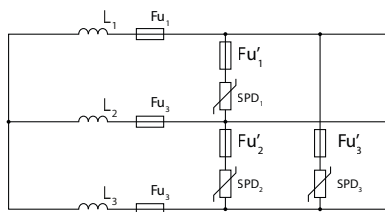

3+0 IT

This type of connection is suitable for protection against transversal overvoltage caused by switching processes. Particular SPDs must be dimensioned for phase-phase voltage.

Fu_1 - Fu_3 represent main protection (fuses, circuit breaker) in the installation. In case when $Fu_1, Fu_2, Fu_3 > \text{Max. back-up fuse for given SPDs (transformed to single phase voltage)}$, Fu'_1, Fu'_2, Fu'_3 have to be used. $Fu'_1, Fu'_2, Fu'_3 \leq \text{Max. back-up fuse of the SPDs}$.

Surge Protection Devices Type 1+2 and Type 2

Wiring diagrams

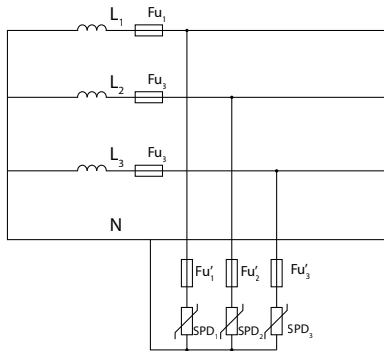

3+0 local isolated system with N conductor (hospitals, chemical industry, etc.)

This type of connection is suitable for protection against transversal overvoltage caused by switching processes. Because such system is designed in order to maximize availability of main voltage, there must be assumed first fault in the system as a standard operational regime. Due to this reason, particular SPDs must be dimensioned for phase-phase voltage (i.e. to 400 V in 230/400 V system).

Fu_1, Fu_2, Fu_3 represent main protection (fuses, circuit breaker) in the installation. In case when $Fu_1, Fu_2, Fu_3 > \text{Max. back-up fuse for given SPDs}$, Fu'_1, Fu'_2, Fu'_3 have to be used. $Fu'_1, Fu'_2, Fu'_3 \leq \text{Max. back-up fuse of the SPDs}$.

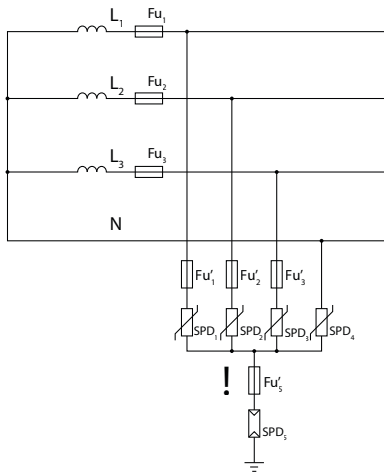

4+1 local isolated with N conductor (hospitals, chemical industry, etc.)

This connection is suitable for limitation of both transversal as well as longitudinal surges. Thanks to SPD_4 , it provides much fine and balanced protection of all phase conductors in comparison to connection 3+1. It also more effectively limits phase – phase transversal overvoltage. Particular devices SPD_1 - SPD_4 are dimensioned for phase voltage (i.e. to 230 V in 230/400 V system). As in standards IT system, sum spark gap SPD_5 has to be protected with back up fuse to ensure insulation of the system. **Local requirements on the sum spark gap have to be followed in particular applications.**

Fu_1, Fu_2, Fu_3 represent main protection (fuses, circuit breaker) in the installation. In case when $Fu_1, Fu_2, Fu_3 > \text{Max. back-up fuse for given SPDs}$, Fu'_1, Fu'_2, Fu'_3 have to be used. $Fu'_1, Fu'_2, Fu'_3 \leq \text{Max. back-up fuse of the SPDs}$. $Fu_5 \leq \text{Max. back up fuse of the sum spark gap } SPD_5$.

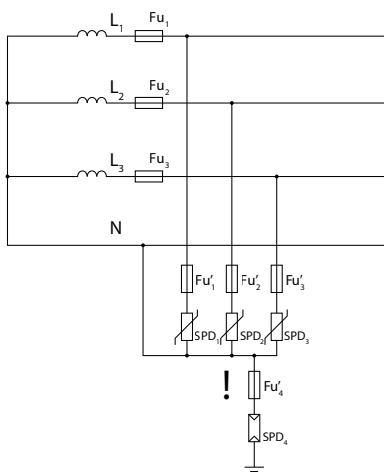

3+1 local isolated with N conductor (hospitals, chemical industry, etc.)

Situation is similar to 4+1 connection. Particular devices SPD_1 - SPD_3 are dimensioned for phase - phase voltage (i.e. to 400 V in 230/400 V system) not to be overloaded in case of the first, generally non-tripped, fault. This connection is suitable for consumers for which transient overvoltage between phase and N conductors matters most. Sum spark gap SPD_4 has to be protected with back up fuse. **Local requirements on the sum spark gap have to be followed in particular applications.**

Fu_1, Fu_2, Fu_3 represent main protection (fuses, circuit breaker) in the installation. In case when $Fu_1, Fu_2, Fu_3 > \text{Max. back-up fuse for given SPDs}$, Fu'_1, Fu'_2, Fu'_3 have to be used. $Fu'_1, Fu'_2, Fu'_3 \leq \text{Max. back-up fuse of the SPDs}$. $Fu_4 \leq \text{Max. back up fuse of the sum spark gap } SPD_4$.

Technical Data Ex9UE2

Surge Protection Devices Type 2, $I_n = 20 \text{ kA}$ (8/20 μs)

General parameters

Suitable for protection of electrical installations against transient overvoltage
Plug-in module design
Indication window helps users to know the status of device
Optional remote-signaling contact

Electrical parameters

	1+0, 2+0, 3+0, 4+0, 1+1, 3+1 (L-N/PE/PEN connection)				1+1, 3+1 (x+1 N-PE connection)
Tested according to	EN 61643-11				
Classified type (test class)	Type 2 (Class II, C, T2)				
Technology	MOV (Varistor)				GDT (Spark-gap)
Rated operational voltage U_n	230 / 400 V AC				
Reference test voltage U_{REF}	255 V AC				
Max. continuous operational voltage U_c	275 V AC	320 V AC	385 V AC	440 V AC	255 V AC
Nominal frequency f	50/60 Hz				
Nominal discharge current I_n (8/20 μs)	20 kA per pole				40 kA per pole
Max. impulse current I_{imp} (10/350 μs)	-				12 kA per pole
Max. discharge current I_{max} (8/20 μs)	40 kA per pole				
Protection voltage U_p at I_n	1.4 kV	1.6 kV	1.9 kV	2.2 kV	1.5 kV
Protection voltage U_p at I_{max}	2 kV	2.3 kV	2.5 kV	2.8 kV	1.5 kV
Protection voltage U_p at 5 kA (8/20 μs)	1 kV	1.15 kV	1.3 kV	1.5 kV	-
N-PE follow current interrupting rating I_n	-				100 A
Temporary overvoltage U_t (withstand)	335 V	405 V	490 V	580 V	1200 V
Residual current I_{PE} at U_{REF}	$\leq 1 \text{ mA}$				-
MOV voltage of 1mA point	387-473 V	460-561 V	554-677 V	639-781 V	-
Response time	$\leq 25 \text{ ns}$				$\leq 100 \text{ ns}$
Max. back-up fuse	max. 125 A gG				-
Short-circuit withstand capability	50 kA				-
Short-circuit current rating I_{SCCR}	10 kA				-
Current factor k	1.6				-
Number of ports	1				
Type of LV system	TN-C, TN-S, TN-C-S, TT (1+1, 3+1), IT (1+1, 3+1)				
Remote contact (optional)	1 changeover (CO)				
Remote contact op. voltage / current					
AC U_{max} / I_{max}					250 V AC / 1 A
DC U_{max} / I_{max}					30 V DC / 1 A

Technical Data Ex9UE2

Surge Protection Devices Type 2, $I_n = 20 \text{ kA} (8/20 \mu\text{s})$

Mechanical parameters

Device width	17.5 mm (per pole/module)
Device height	83 mm (89 mm including rail clip)
Frame size	45 mm
Method of mounting	fixed
Mounting	easy fastening onto 35 mm device rail (DIN)
Mounting position	arbitrary
Degree of protection	IP40, terminals IP20
Terminals	combined lift + open mouthed, M5 screws
Terminal capacity	2.5 — 35 mm ²
Fastening torque of terminals	2 — 3.5 Nm
Remote contact terminal capacity	0.14 — 1.5 mm ²
Location	indoor
Ambient temperature	-40 — +80 °C
Altitude	≤ 2000 m
Relative humidity	30 — 90 %
Weight (per pole)	0.11 kg

Dimensions

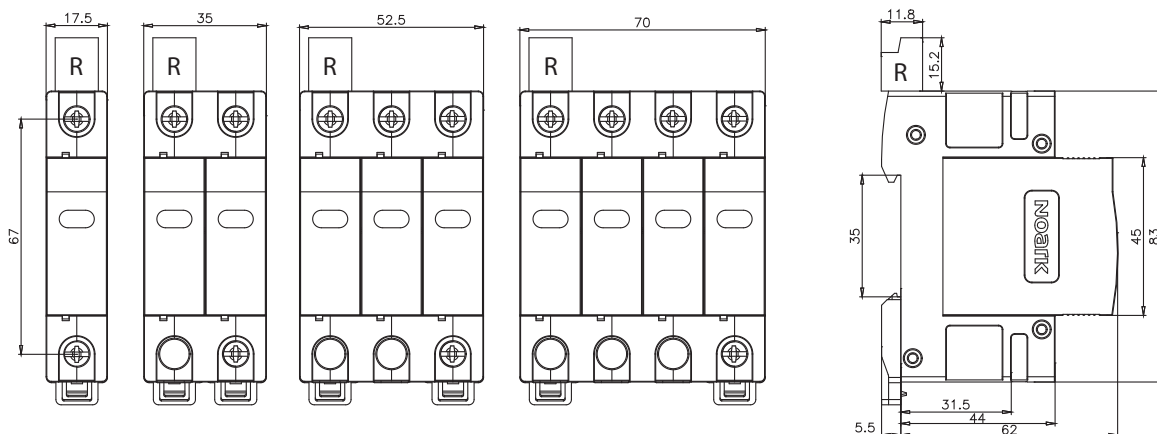

Technical Data Ex9UE2

Surge Protection Devices Type 2, $I_n = 20 \text{ kA} (8/20 \mu\text{s})$

SPD coordination

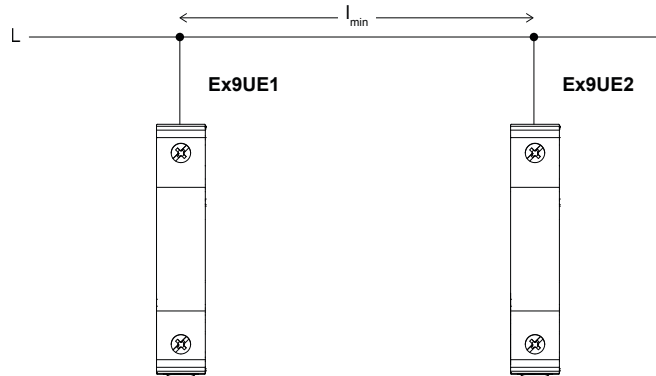

Class I	Class II	Min. cable length l_{\min}
Ex9UE1 35	Ex9UE2 x x 440	0
Ex9UE1 35	Ex9UE2 x x 275	$\geq 10 \text{ m}$

Connection diagrams, protection mode

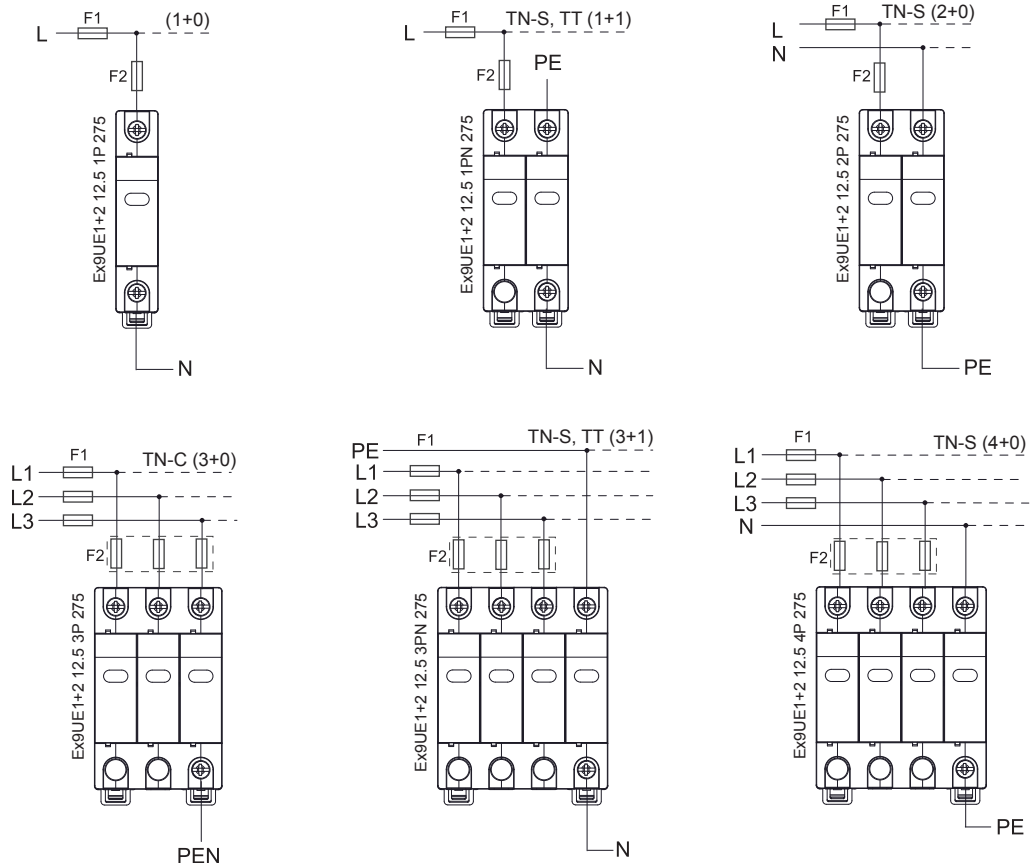

Technical Data Ex9UE3

Surge Protection Devices Type 3, $U_{oc} = 10 \text{ kV}$

General parameters

Suitable for protection of electrical installation and devices against transient overvoltage
Plug-in module design
Indication window helps users to know the status of device
Optional remote-signaling contact

Electrical parameters

Tested according to	EN 61643-11
Classified type (test class)	Type 3 (Class III, D, T3)
Technology	MOV (Varistor) + Spark gap
Protection function	overcurrent
Protection mode	L → N L → PE N → PE
Connection configuration	Y
Nominal voltage U_n	230 / 400 V AC
Max. continuous oper. voltage U_c	275 V AC
Nominal frequency f	50 / 60 Hz
Nominal discharge current I_n (8/20 μs)	5 kA per pole
Max. discharge current I_{max} (8/20 μs)	10 kA per pole
Nominal load current I_L	25 A
Open circuit voltage U_{oc}	10 kV
Protection voltage U_p at U_{oc}	
L-N	1.25 kV
N-PE	1.5 kV
N-PE follow current I_n	-
Residual current I_{PE}	< 1 mA
Temporary overvoltage U_t (withstand)	
L-N, 5 s	335 V
N-PE, 200 ms	440 V
MOV voltage of 1mA point	387 - 473 V
Max. back-up fuse	10 A MCB with C characteristic
Type of LV system	TN or TT
SPD overload behaviour mode	OCM
Remote contact (optional)	1 changeover (CO)
Number of ports	1
Remote contact op. voltage / current	
AC U_{max} / I_{max}	250 V AC / 1 A
DC U_{max} / I_{max}	30 V DC / 1 A

Technical Data Ex9UE3

Surge Protection Devices Type 3, $U_{oc} = 10 \text{ kV}$

Mechanical parameters

Device width	17.5 mm
Device height	83 mm (89 including rail clip)
Frame size	45 mm
Mounting method	fixed
Mounting	easy fastening onto 35 mm device rail (DIN)
Mounting position	arbitrary
Degree of protection	IP40, terminals IP20
Terminals	lift
Terminal capacity	1 — 4 mm ²
Fastening torque of terminals	0.3 — 0.5 Nm
Remote contact terminal capacity	0.14 — 1.5 mm ²
Location	indoor
Installation class	III
Pollution degree	2
Accessibility	inaccessible
Ambient temperature	-5 — +40 °C
Altitude	≤ 2000 m
Relative humidity	30 — 90 %
Weight	0.08 kg

Dimensions

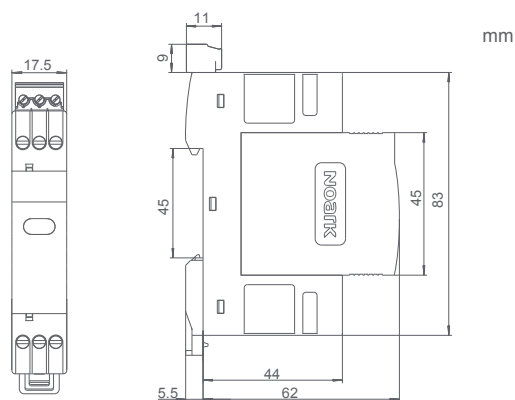

Connection diagrams, protection mode

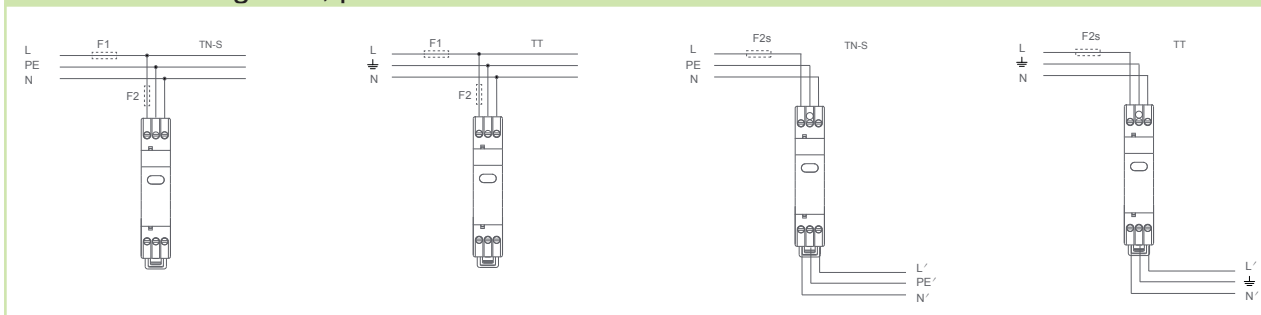

Technical Data Ex9CH20

Installation relays

General parameters

1, 2 and 4-contact versions, various contact combinations
Indication window help users to know the status of device
Low operating noise level

Electrical parameters

Tested according to	IEC / EN 61095
Rated operational voltage U_e	230/400 V AC
Control voltage U_c	24 V AC / 230 V AC / 240 V AC
Rated insulation voltage U_i	500 V
Rated impulse withstand voltage U_{imp}	4 kV
Rated conventional thermal current I_{th}	20 A
Rated current I_e AC-1, AC-7a	20 A
Rated current I_e AC-7b	9 A
Controlled power AC-7a	4 kW
Electrical service life	100 000 operating cycles
Max. switching frequency	300 per hour
Duty	100 %
Making and breaking conditions AC-7a	
I_c/I_e	1.0
U_f/U_e	1.05
$\cos \varphi$	0.8
Coil power consumption (2P / 4P)	3.68 / 5.31 VA 1.47 / 1.56 W
Ambient temperature	-5 — +40 °C (+40 — +70 °C derated)
Rated thermal current in different ambient temperature (derating)	
40 °C	20 A
50 °C	18 A
60 °C	16 A
70 °C	14 A

Mechanical parameters

Device width	1 and 2-contact versions: 18 mm (1MU) 4-contact versions: 36 mm (2MU)
Device height	81 mm (84.5 including rail clip)
Frame size	45 mm
Mounting	easy fastening onto 35 mm device rail (DIN)
Degree of protection	IP20
Terminals	M3.5 screws
Terminal capacity	1 — 4 mm ²
Fastening torque of terminals	0.8 Nm
Control coil terminal	M3.5 screws
Control coil terminal capacity	1 — 4 mm ²
Fastening torque of control terminals	0.8 Nm
Mechanical service life	1 000 000 operating cycles
Pollution degree	2
Installation class	III
Weight	0.12 kg (1MU), 0.21 kg (2MU)

Technical Data Ex9CH20

Installation relays

Dimensions

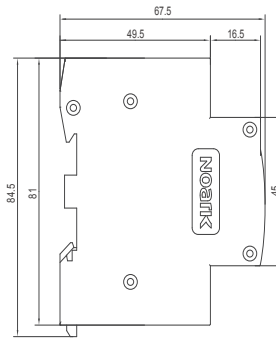
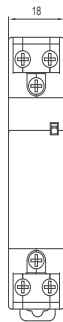

1, 2-contact versions

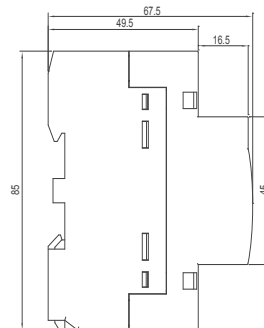
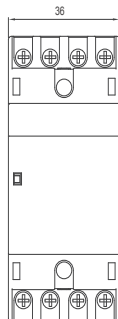

4-contact versions

Mounting position

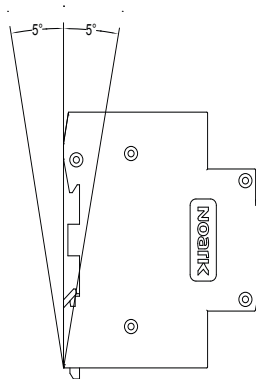

Wiring diagrams

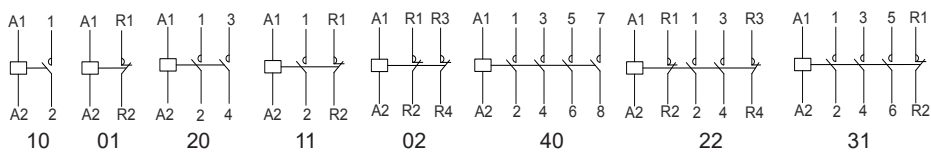

Technical Data Ex9CH

Installation contactors

General parameters

Indication window help users to know the status of device
Low operating noise level

Electrical parameters

	ExCH25	ExCH40	ExCH63
Tested according to	IEC / EN 61095		
Rated operational voltage U_e	230/400 V AC		
Control coil voltage U_c	24 V AC / 230 V AC / 240 V AC		
Rated insulation voltage U_i	500 V		
Rated impulse withstand voltage U_{imp}	4 kV		
Rated conventional thermal current I_{th}	25 A	40 A	63 A
Rated current AC-1, AC-7a I_e	25 A	40 A	63 A
Controlled power AC-7a	16 kW	26 kW	40 kW
Electrical service life	100 000 operating cycles		
Max. switching frequency	300 per hour		
Duty	100 %		
Making and breaking conditions AC-7a			
I_c/I_e	1.0		
U_c/U_e	1.05		
$\cos \varphi$	0.8		
Coil power consumption (2P / 4P)	- / 5.31 VA - / 1.56 W	5.10 / 7.13 VA 1.50 / 2.09 W	5.10 / 7.13 VA 1.50 / 2.09 W
Ambient temperature	-5 — +40 °C (+40 — +70 °C derated)		
I_{th} in different ambient temperature			
40°C	25 A	40 A	63 A
50°C	22 A	38 A	57 A
60°C	18 A	36 A	50 A
70°C	16 A	32 A	46 A

Mechanical parameters

	ExCH25	ExCH40	ExCH63
Modules	2-contact: 18 mm (1MU) 4-contact: 36 mm (2MU)	2-contact: 36 mm (2MU) 4-contact: 54 mm (3MU)	2-contact: 36 mm (2MU) 4-contact: 54 mm (3MU)
Device width	18 mm (per module)		
Device height	81 mm (84.5 incl. rail clip)	85 mm	85 mm
Frame size	45 mm		
Mounting	easy fastening onto 35 mm device rail (DIN)		
Degree of protection	IP20		
Terminals	M3.5 screws	M5 screws	M5 screws
Terminal capacity	1 — 4 mm ²	2.5 — 16 mm ²	2.5 — 16 mm ²
Fastening torque of terminals	0.8 Nm	2 Nm	2 Nm
Control coil terminal	M3.5 screws		
Control coil terminal capacity	1 — 4 mm ²		
Fastening torque of control terminals	0.8 Nm		
Mechanical service life	1 000 000 operating cycles		
Pollution degree	2		
Installation class	III		
Weight	0.12 kg (1MU), 0.21 kg (2MU)	0.22 kg (2MU), 0.4 kg (3MU)	0.22 kg (2MU), 0.4 kg (3MU)

Technical Data Ex9CH

Installation contactors

Dimensions

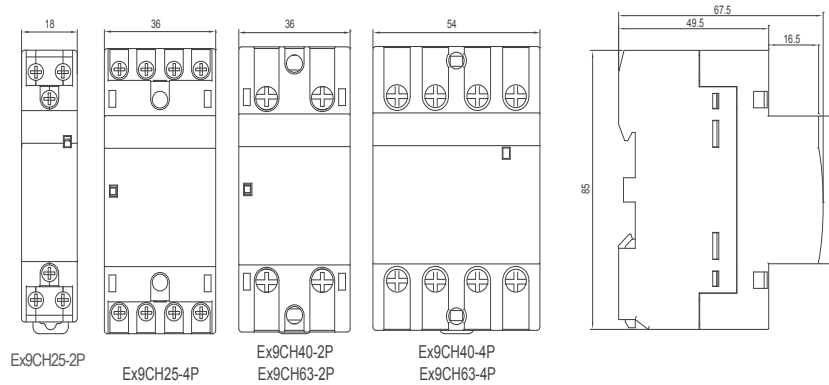

Mounting position

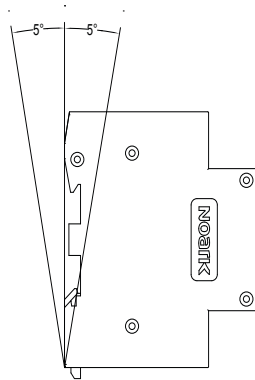

Wiring diagrams

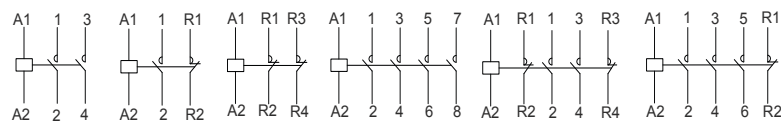

Technical Data Ex9CHM

Installation contactors with manual operation

General parameters

Shall not be used for breaking short-circuit current, therefore it should be used with a proper short-circuit protection device.

Indication window help users to know the status of device

4 adjustable positions (I , AUTO , O , I+P)

Electrical parameters

		16A	20A	25A	32A	40A	63A
Tested according to		IEC/EN 61095					
Rated operational voltage U_e		250 (2P), 400 (4P) V					
Rated control power voltage U_s		24 V AC / 110 V AC / 220~240V AC					
Rated insulation voltage U_i		500 V					
Rated impulse withstand voltage U_{imp}		4 kV					
Rated conventional thermal current I_{th}		25 A	25 A	25 A	63 A	63 A	63 A
Rated current I_n							
	AC-7a	16 A	20 A	25 A	32 A	40 A	63 A
	AC-7b	6 A	7 A	9 A	12 A	18 A	25 A
Controlled power							
AC-7a	250 V	3.5 kW	4.5 kW	5.5 kW	8 kW	9 kW	14 kW
	400 V	6 kW	7.5 kW	9.5 kW	12 kW	15 kW	24 kW
AC-7b	250 V	1.4 kW	1.6 kW	2 kW	3 kW	4 kW	5.5 kW
	400 V	2.2 kW	2.5 kW	3.2 kW	4.5 kW	6 kW	8 kW
Electrical service life		80 000 operating cycles					
Number of main contacts							
	2P	1NO 1NC, 2NO, 2NC					
	4P	2NO 2NC, 3NO 1NC, 4NO, 4NC					
Rated duty system							
	Intermittent	30 times/h load factor 40%					
	Eight hours	basic duty system					
Ambient temperature		-25 — +70 °C					

Mechanical parameters

		16A	20A	25A	32A	40A	63A
Frame size		45 mm					
Width (2P / 4P)		18 / 36 mm			36 / 54 mm		
Mounting		easy fastening onto 35 mm device rail (DIN)					
Degree of protection		IP20					
Terminals		M3.5 screws			M5 screws		
Terminal capacity		1 — 4 mm ²			2.5 — 16 mm ²		
Fastening torque of terminals		0.8 Nm			3.5 Nm		
Control coil terminal		M3.5 screws					
Fastening torque of control terminals		2 Nm					
Wiring							
Control circuit	Hard wire	1.5~2.5 mm ²			2×1.5 mm ²		
	Flexible wire	1.5~2.5 mm ²			2×2.5 mm ²		
Power circuit	Hard wire	1.5~6 mm ²			6~25 mm ²		
	Flexible wire	1.5~4 mm ²			6~16 mm ²		
Mechanical service life		1 000 000 operating cycles					
Pollution degree		2					
Installation class		II					
Weight		0.119 kg (2 pole), 0.207 kg (4 pole)			0.233 kg (2 pole), 0.336 kg (4 pole)		

Technical Data Ex9CHM

Installation contactors with manual operation

Dimensions

Ex9CH16/20/25M

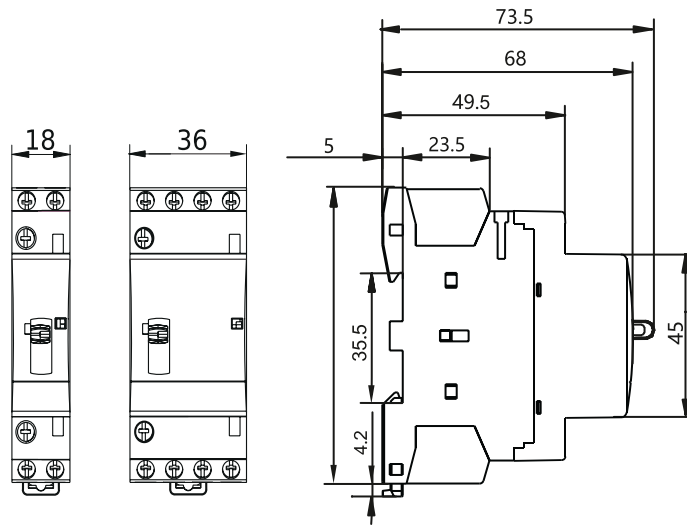

Ex9CH32/40/63M

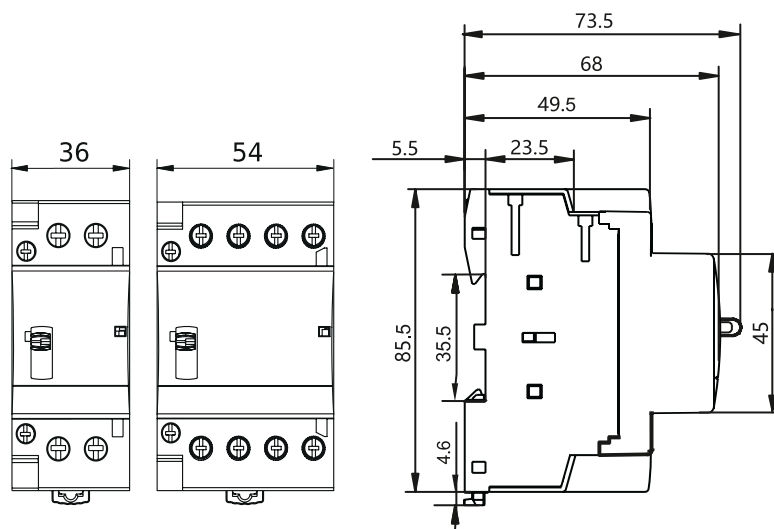

Mounting position

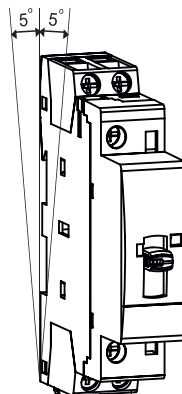

Technical Data Ex9CHM

Installation contactors with manual operation

Operation principles

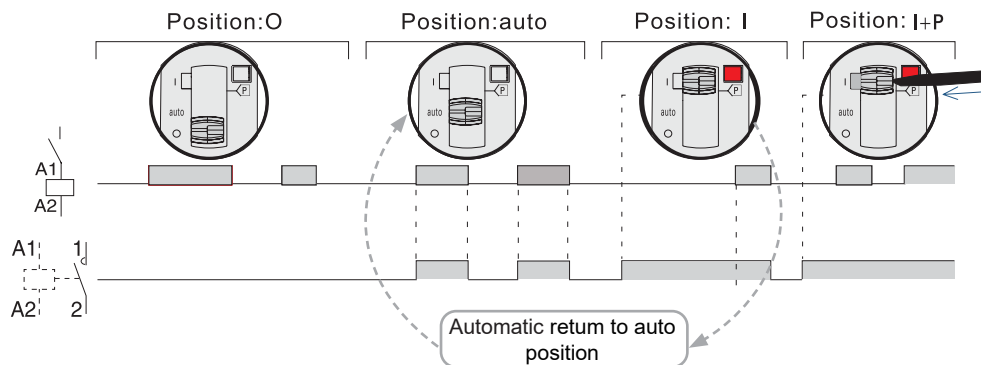

Wiring diagrams

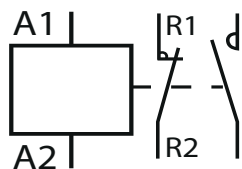

Ex9CH16~25 M
1NO+1NC

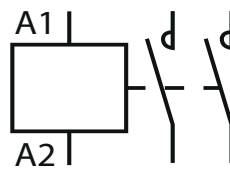

Ex9CH16~63 M
2NO

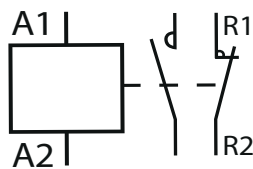

Ex9CH32~63 M
1NO+1NC

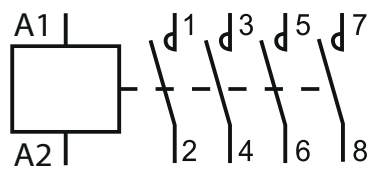

Ex9CH16~63 M
4NO

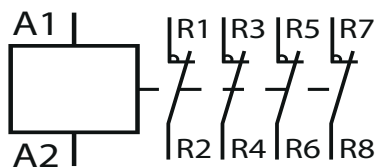

Ex9CH16~63 M
4NC

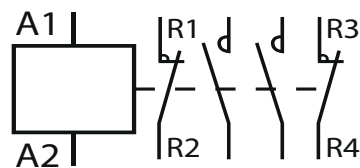

Ex9CH16~63 M
2NO+2NC

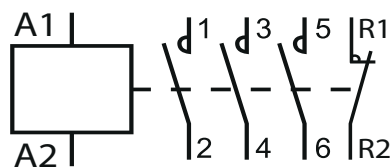

Ex9CH16~63 M
3NO+1NC

Technical Data Ex9JU

Impulse relays

General parameters

1, 2, 3 and 4-contact versions
Hardware switches on a front of device for manual control

Electrical parameters

	Ex9JU-16	Ex9JU-32
Tested according to	IEC/EN 61810-1:2015	
Rated operational voltage U_e	250 V AC / 28 V DC	
Coil rated voltage U_c	24 V AC / 220 V AC / 230 V AC 24 V DC / 127 V DC	
Control voltage range	85 — 110 % U_c	
Rated frequency f	50 Hz	
Maximum switching voltage	250 V AC / 125 V DC	
Rated insulation voltage U_i	500 V	
Rated impulse withstand voltage U_{imp}	4 kV	
Maximum switching current	16 A	32 A
Maximum switching power	4000 VA (250 V AC) / 448 W (28 V DC)	8000 VA (250 V AC) / 896 W (28 V DC)
Electrical service life	100 000 operating cycles	
Max. switching frequency	720 per hour	
Coil power consumption		
1P	8.28 VA 7.68 W	12.42 VA 7.68 W
2P		24.84 VA 15.36 W
3P	16.56 VA 15.36 W	37.26 VA 23.04 W
4P		49.68 VA 30.72 W
Ambient temperature	-25 — +55 °C	
Impulse duration	50 ms (minimum) 200 ms (recommended) 1000 ms (maximum)	
Switching delay (ON / OFF)	20 / 15 ms	
Overvoltage category	II	

Mechanical parameters

	Ex9JU-16	Ex9JU-32
Device width (1P / 2P / 3P / 4P)	18 / 18 / 36 / 36 mm	18 / 36 / 54 / 72 mm
Device height	83.2 mm (86 mm including rail clip)	
Frame size	45 mm	
Mounting	easy fastening onto 35 mm device rail (DIN)	
Mounting position	any	
Degree of protection	IP20	
Terminals	M3.5 screws	M4 screws
Terminal capacity	2.5 — 4 mm ²	4 — 6 mm ²
Fastening torque of terminals	0.8 Nm	1.2 Nm
Control coil terminal	M3.5 screws	
Control coil terminal capacity	2.5 — 4 mm ²	
Fastening torque of control terminals	0.8 Nm	
Mechanical service life	1 000 000 operating cycles	
Pollution degree	1	
Installation class	III	
Weight (1MU / 2MU / 3MU / 4MU)	0.11 / 0.22 / 0.33 / 0.44 kg	

Technical Data Ex9JU

Impulse relays

Dimensions

Ex9JU-16

mm

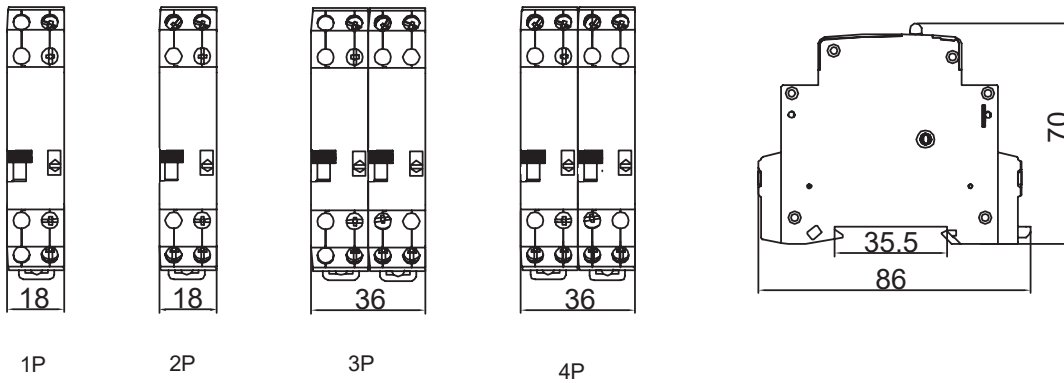

Ex9JU-32

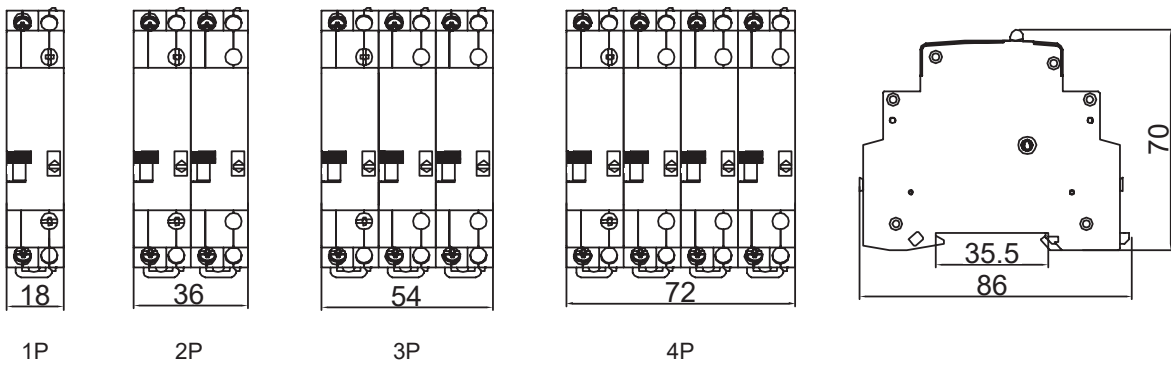

Wiring diagrams

Ex9JU-16

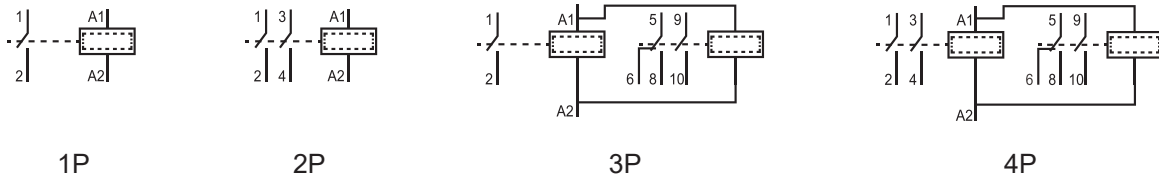

Ex9JU-32

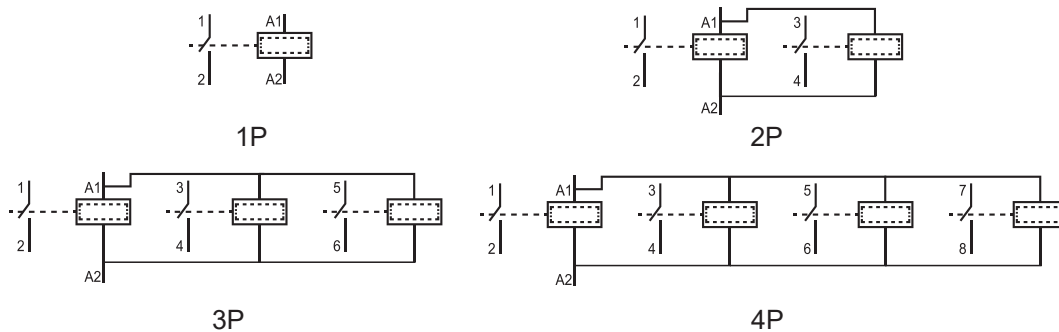

Technical Data Ex9BT

Change-Over Switches

General parameters

Modular change-over switches for switching of auxiliary, control, measuring and other circuits
Also versions in combination with independent signal lamp
Various contact combinations
Suitable for household as well as industrial applications

Electrical parameters

Tested according to	EN 60669-1
Rated op. voltage	230 / 400 V AC
Rated frequency	50 Hz
Rated current I _e	16, 32 A
Number of contacts	1, 2, 3, 4
LED voltage	12-48 V AC/DC 115-230 V AC/DC
LED power loss	290 mW
Rated insulation voltage U _i	690 V
Maximum back-up fuse	125 A gG
Mechanical service life	20 000 operation cycles
Electrical service life	4 000 operation cycles

Mechanical parameters

Device width	18 mm
Device height	83 mm (89 mm including rail clip)
Frame size	45 mm
Mounting	easy fastening onto 35 mm device rail (DIN)
Degree of protection	IP20
LED Color	white
Toggle color	green - NO contacts only red - NC contacts only black - CO only or contact combination
Terminals	lift
Terminal capacity	1 — 10 mm ²
Fastening torque of terminals	2 — 3,5 Nm
Ambient temperature	-30 — +70 °C
Altitude	≤ 2000 m
Relative humidity	≤ 95 %
Resistance to humidity and heat	class 2
Pollution degree	2
Installation class	III
Weight	0.09 kg

Technical Data Ex9BT

Change-Over Switches

Dimensions

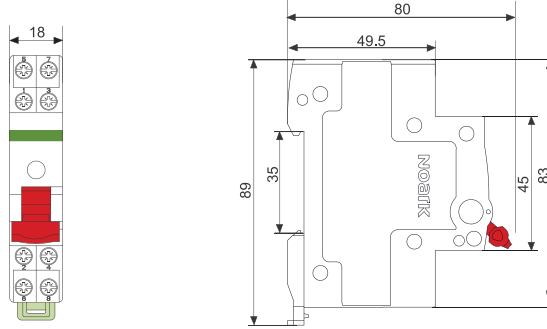

Wiring diagrams

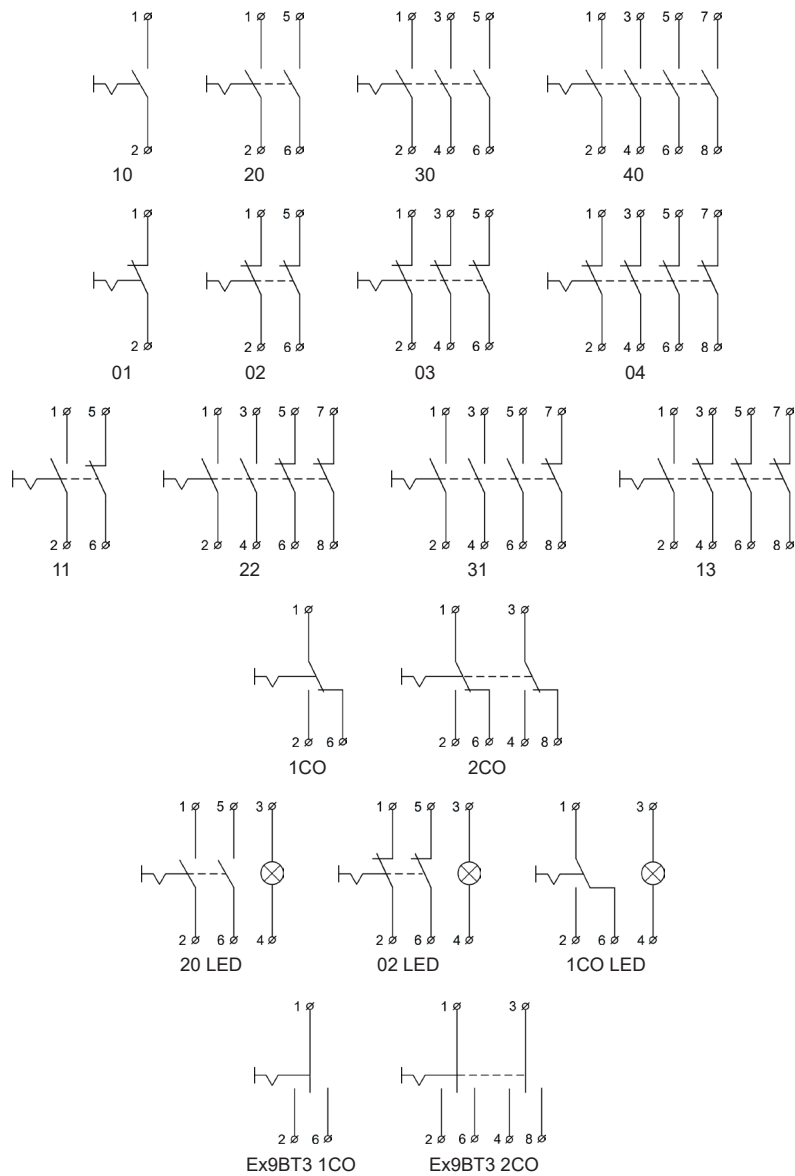

Technical Data Ex9PD

Installation signal lamps

General parameters

Modular design
Suitable e.g. for circuit status indication
Based on LED technology

Electrical parameters

Tested according to	IEC / EN 60947-5-1
Light technology	LED
Number of LEDs	1, 2
LED colours	red, yellow, green, blue, white
Rated operating voltage U_e	6.3 V AC/DC 12 V AC/DC 24 V AC/DC 110 V AC/DC 230 V AC/DC
Rated current I_e	≤ 20 mA / LED
Rated insulation voltage U_i	500 V
Electrical service life	≥ 30 000 working hours
LED lumiance L_v	≥ 60 cd/m ²

Mechanical parameters

Device width	18 mm
Device height	81 mm (84.5 mm including rail clip)
Frame size	45 mm
Mounting	easy fastening onto 35 mm device rail (DIN)
Degree of protection	IP20
Terminals	lift
Terminal capacity	1 — 2.5 mm ²
Fastening torque of terminals	0.8 Nm
Ambient temperature	-5 — +40 °C
Altitude	≤ 2000 m
Relative humidity	≤ 95 %
Resistance to humidity and heat	class 2
Pollution degree	2
Installation class	III
Weight	0.09 kg per pole

Technical Data Ex9PD

Installation signal lamps

Dimensions

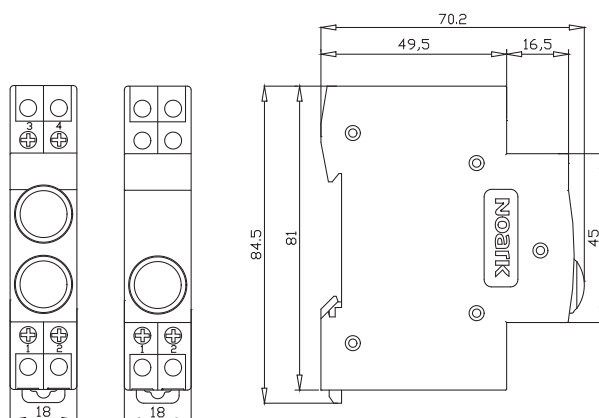

Wiring diagrams

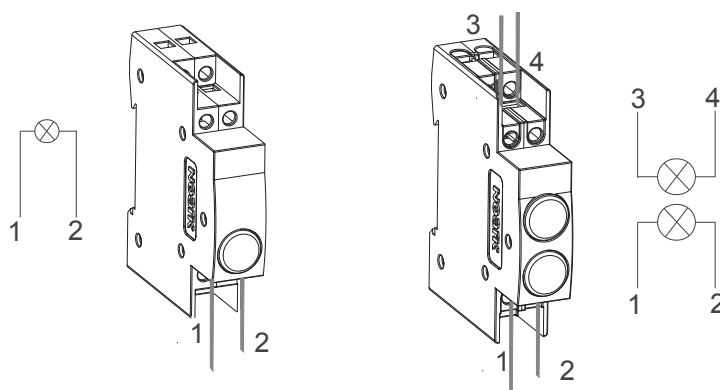

Technical Data Ex9PDe

Installation signal lamps

General parameters

Modular design
Suitable e.g. for circuit status or phase connection indication
Based on LED technology

Electrical parameters

	Ex9PD1e, Ex9PD2e	Ex9PD3e
Tested according to	IEC/EN 60947-5-1	
Light technology	LED	
Number of LEDs	1, 2	3
LED colours	red/green	red
Rated operating voltage U_e	24, 48, 230 V AC/DC	230/400 V AC
Rated current I_e	≤ 20 mA / LED	
Conventional free air thermal current I_{th}	20 mA	
Rated insulation voltage U_i	500 V	
Rated impulse withstand voltage U_{imp}	4 kV	
Electrical service life	$\geq 30\,000$ working hours	
LED luminance L_v	≥ 40 cd/m ²	

Mechanical parameters

Device width	18 mm
Device height	81 mm (85.5 mm including rail clip)
Frame size	45 mm
Mounting	easy fastening onto 35 mm device rail (DIN)
Degree of protection	IP20
Terminals	lift
Terminal capacity	1 — 2.5 mm ²
Fastening torque of terminals	0.8 Nm
Ambient temperature	-5 — +40 °C
Altitude	≤ 2000 m
Relative humidity	≤ 90 % at +20°C
Resistance to humidity and heat	class 2
Pollution degree	3
Installation class	III
Weight	0.06 kg

Technical Data Ex9PDe

Installation signal lamps

Dimensions

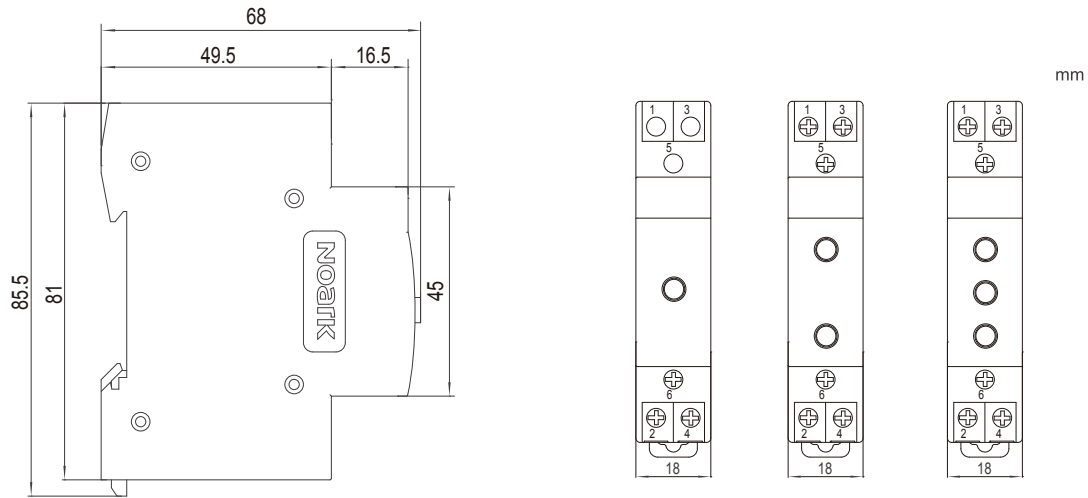

Wiring diagrams

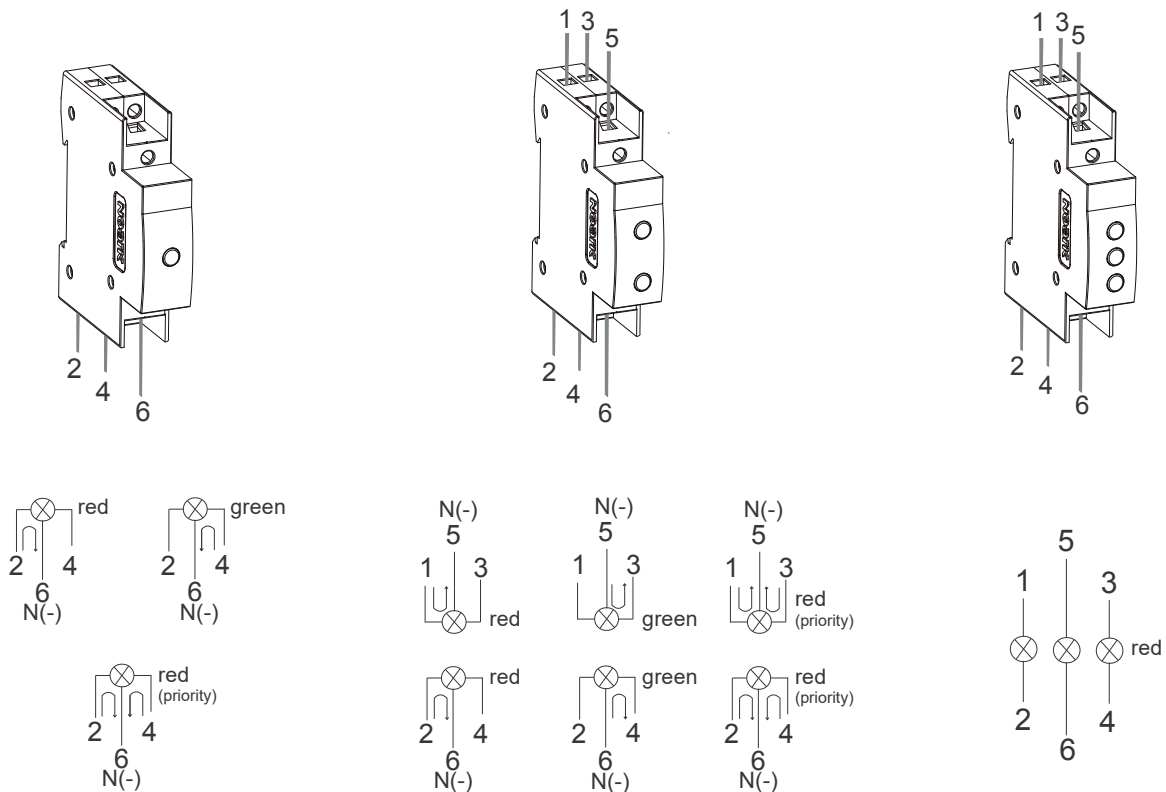

Technical Data Ex9TAM2

Analogue Time Switches

General parameters

Miniature (1MU width) version
Quartz or grid synchronous time basis

Electrical parameters

	Ex9TAMS2	Ex9TAMQ2
Tested according to	EN 60730-1, EN 60730-2-7	
Rated operating voltage U_e	230 V AC	
Rated frequency f	45 — 60 Hz	
Rated current I_e		
AC-1, $\cos \varphi$ 1	16 A	
AC-3, $\cos \varphi$ 0.6	4 A	
Channels	1	
Switch contact	1 NO	
Switching capacity (incandescent lamps)	3500 W	
Rated insulation voltage U_i	250 V AC	
Power consumption	2.5 VA / 0,25W	
Time basis	Synchronous	Quartz
Accuracy	+/- 3 sec/day	
Power reserve	-	100 h
Charging time	-	100 h
Switching program	daily	
Shortest switching time	15 min.	
Programmable	every 30 min. (15 min. ON + 15 min. OFF)	
Pollution degree	2	
Manual switch	⊕ = Auto	I = fix ON

Mechanical parameters

Device width	17.5 mm
Device height	90 mm
Frame size	45 mm
Mounting	onto 35 mm device rail (DIN)
Degree of protection	IP20
Terminals	screw terminals
Terminal capacity	1,5 — 4 mm ²
Fastening torque of terminals	0.8 Nm
Ambient temperature	-10°C — +50°C
Rate of pollution	Normal
Installation class	II
Sealable	yes
Weight	0.075 kg

Technical Data Ex9TAM2

Analogue Time Switches

Dimensions

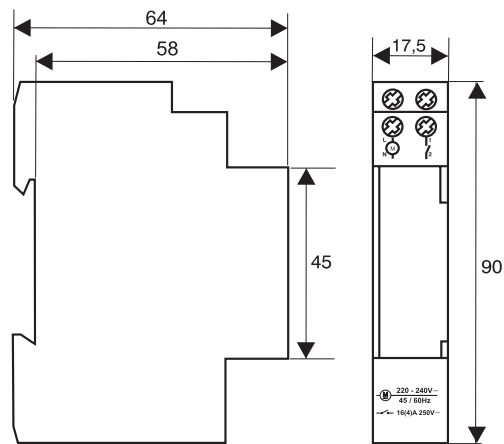

Wiring diagrams

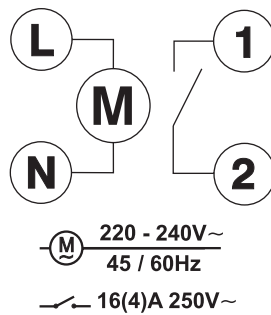

Programming

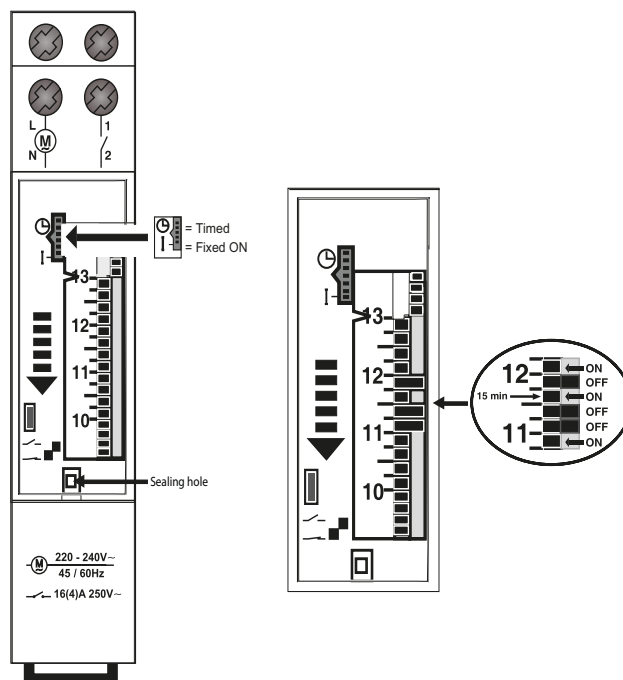

Technical Data Ex9TDM

Miniature Digital Time Switches

General parameters

Miniature (1MU) width versions
Switching state LCD display
Weekly and Holiday switching program, auto summer/wintertime change

Electrical parameters

Tested according to	EN 60730-1, EN 60730-2-7
Rated operating voltage U_e	230 V AC
Rated frequency f	50/60 Hz
Rated current I_e	
AC-1, $\cos \varphi$ 1	16 A
AC-3, $\cos \varphi$ 0.6	8 A
Rated insulation voltage U_i	2500 V AC
Power consumption	5 VA
Rated load AC1 / AC15	-
Channels	1
Switch contact	1 CO
Switching capacity AC	
Incandescent lamps	1000 W
Sw. capacity DC (24V / 50V / 220V)	800 / 300 / 150 mA
Min. switching load	-
Shortest switching time	1 min.
Programmable	every 1 min.
PC programming	-
Weekly switching program	ON/OFF
Holiday switching program	ON/OFF
Free weekday block	-
Manual switch	ON/OFF
Astro program	-
Auto summer/wintertime change	yes
Switching state display	yes
Time basis	Quartz
Accuracy	± 1 sec./day
Power reserve (at +20°C)	3 years
Replaceable battery type	CR2032
Memory spaces	50
Hour counter	-
PIN coded setup	-
Random switching	-
External input	-

Technical Data Ex9TDM

Miniature Digital Time Switches

Mechanical parameters

Device width	17.5 mm
Device height	90 mm
Frame size	45 mm
Mounting	onto 35 mm device rail (DIN)
Degree of protection	IP20
Terminals	screw terminals
Terminal capacity	2.5 mm ²
Fastening torque of terminals	1.2 Nm
Ambient temperature	-10°C — +55°C
Installation class	II
Weight	0.1 kg

Dimensions

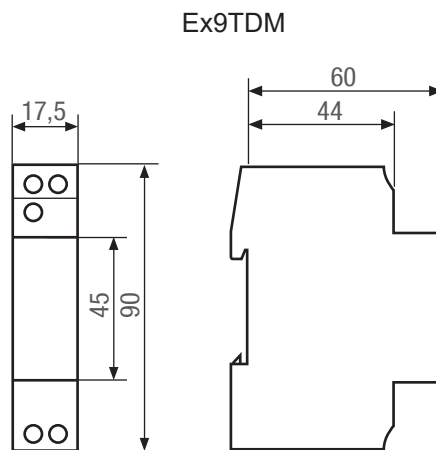

Wiring diagrams

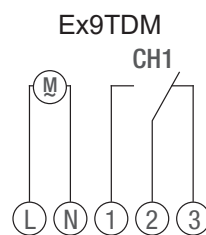

Technical Data Ex9DTS

Digital Time Switches

General parameters

Standard width (2MU) versions
Switching state LCD display
Daily, weekly and holiday switching program; Ex9DTSC adds monthly and yearly switching program
Automatic summer/wintertime change
Sealable front cover
Information about setting and usage are in manual available at www.noark-electric.eu

Electrical parameters

	Ex9DTS	Ex9DTSC
Tested according to	IEC EN 61812-1, IEC EN 61010-1	
Rated operating voltage U_e	230 V AC	
Operating voltage tolerance U_e	200 — 253 V AC	
Rated frequency f	50 / 60 Hz	
Rated current I_e (AC-1, $\cos \varphi$ 1)	16 A	
Power consumption	14 VA / 2 W	
Channels	1 / 2	
Switch contacts	1 CO / 2 CO	
Peak current	30 A / < 3 s	
Shortest switching time	1 s	
Programmable	every 1 min	
Breaking capacity	4000 VA / AC1, 384 W / DC	
Switching voltage	250 V AC1 / 24 V DC	
Electrical strength	4 kV	
Electrical service life	70 000 operation cycles	
Real time back-up	yes (up to 3 years)	
Accuracy	± 1 s / day	
Auto summer/wintertime change	yes	
Switching state display	yes, backlight	
Power reserve for data (at +20°C)	10 years	
Memory spaces	100	
Cyclic output	1 — 240 s	
Pulse output	1 — 240 s	
Programs	daily, weekly, holiday	daily, weekly, monthly, yearly, holiday
Overvoltage category	III	
Polution degree	2	

Technical Data Ex9DTS

Digital Time Switches

Mechanical parameters

	Ex9DTS	Ex9DTSC
Device width	35.6 mm	
Device height	90 mm	
Device depth	64 mm	
Frame size	45 mm	
Mounting	onto 35 mm device rail (DIN)	
Mechanical service life	10 000 000 operation cycles	
Degree of protection	IP10	
Terminals	screw terminals	
Terminal capacity	1 — 4 mm ²	
Fastening torque of terminals	1 Nm	
Ambient temperature	-20°C — +55°C	
Mounting position	any	
Installation class	II	
Weight (1CO / 2CO)	0.13 kg / 0.14 kg	

Dimensions

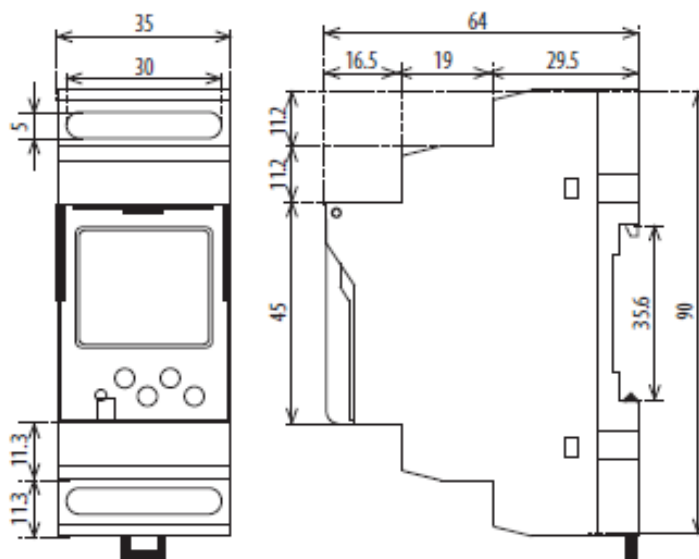

Wiring diagrams

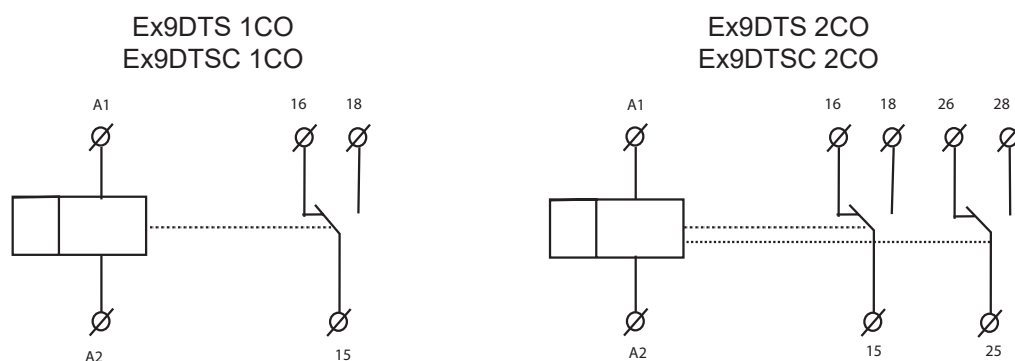

Technical Data Ex9DTS

Digital Time Switches

Connections

Ex9DTS 1CO 230V
Ex9DTSC 1CO 230V

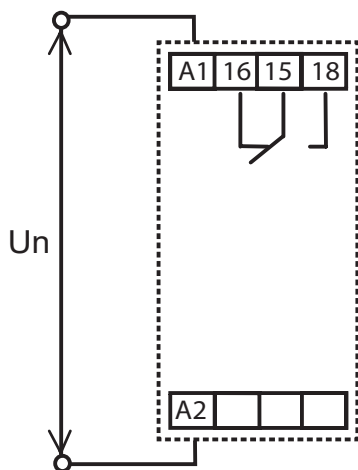

Ex9DTS 2CO 230V
Ex9DTSC 2CO 230V

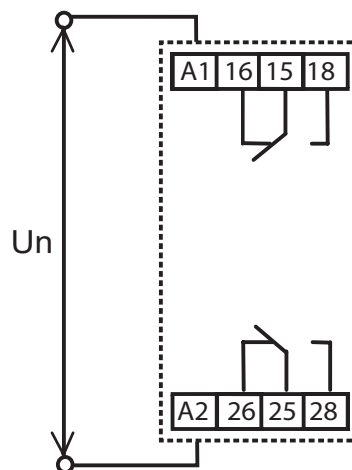

Technical Data Ex9SS

Staircase Switches

General parameters

Time adjustment range from 0.5 to 10 minutes
Manual control switch on the front side
Basic and programmable version
Automatic recognition of 3 or 4-line connection

Electrical parameters

	Ex9SSB	Ex9SSP
Functions	ON / OFF / AUTO	ON / OFF / a / b
Tested according to	EN 60669-2-3, EN 61010-1	
Rated operating voltage U_e	230 V AC	
Operating voltage tolerance	200 — 253 V AC	
Rated frequency f	50/60 Hz	
Rated current I_e	16A / AC1	
Max. power input	3 VA / 1.6 W	
Power consumption	≤ 4 VA	
Supply indication	green LED	
Switch contact	1 CO	1 NO
Adjustment range	0.5 — 10 min	
Time setting	potenciometr	
Time deviation	5 % - mechanical setting	
Repeat accuracy	5 % - set value stability	
Breaking capacity	4000 VA / AC1, 384 W / DC	
Inrush current	30 A / < 3 s	
Switching voltage	250 V AC1 / 24 V DC	
Output indication	red LED	
Electrical life (AC1)	70 000 operation cycles	
Max. control power input	4.5 VA / 0.3 W	
Glow tube connections	yes	
Max. current of connected glow lamps	100 mA	
Impulse length	min. 40 ms / max. unlimited	
Reset time	max. 320 ms	

Mechanical parameters

Device width	17.6 mm
Device height	90 mm
Frame size	45 mm
Mounting	onto 35 mm device rail (DIN)
Mounting position	any
Degree of protection	IP20
Terminals	screw terminals
Terminal capacity	1 — 2.5 mm ²
Fastening torque of terminals	0.8 Nm
Mechanical life	10 000 000 operation cycles
Ambient temperature	-20°C — +55°C
Overvoltage category	III
Installation class	II
Pollution degree	2
Weight	0.056 kg

Technical Data Ex9SS

Staircase Switches

Dimensions

Ex9SSB

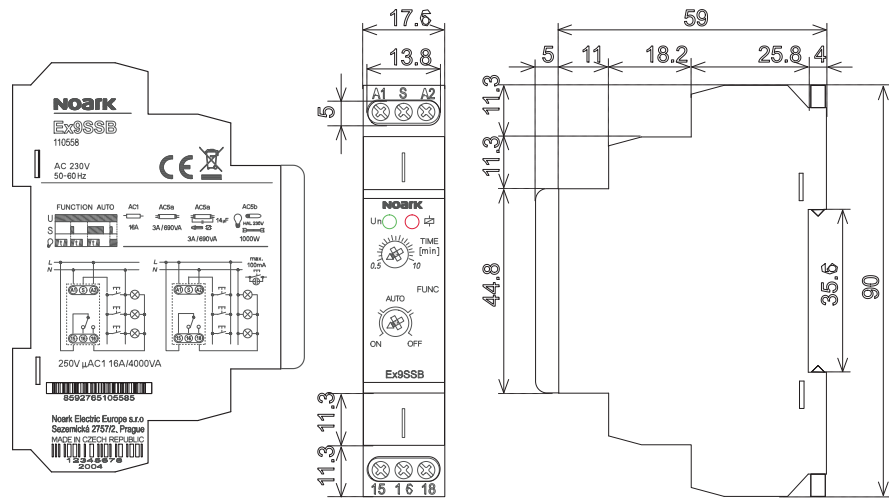

Ex9SSP

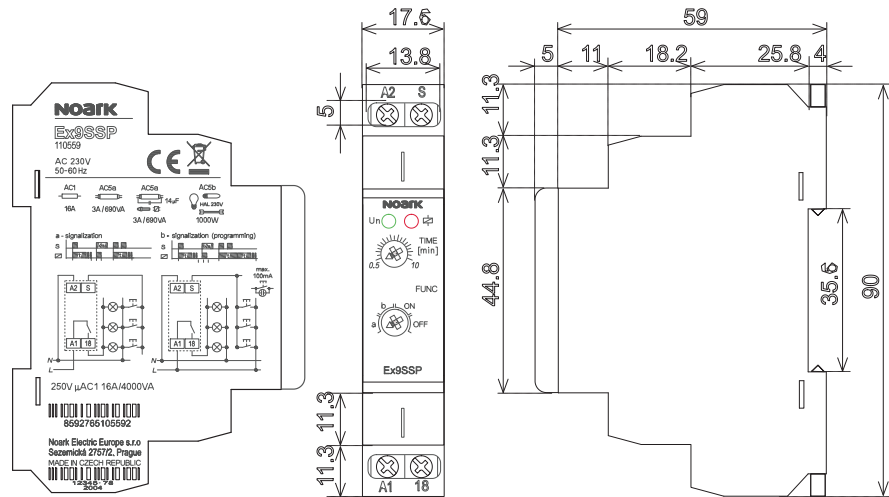

Wiring diagrams

Ex9SSB

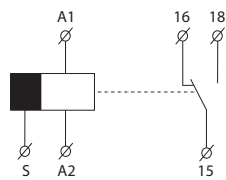

Ex9SSP

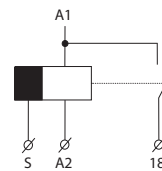

Technical Data Ex9SS

Staircase Switches

Connections

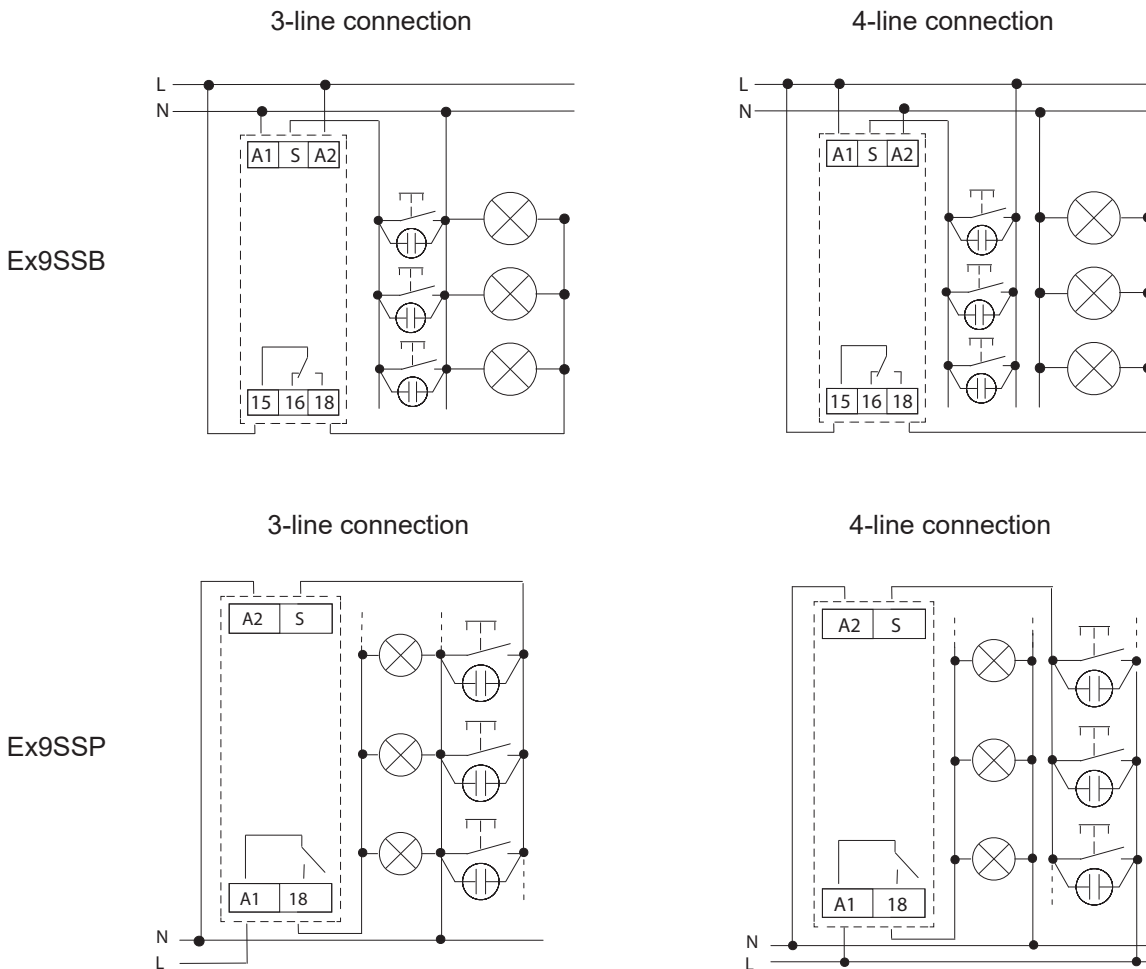

Functions

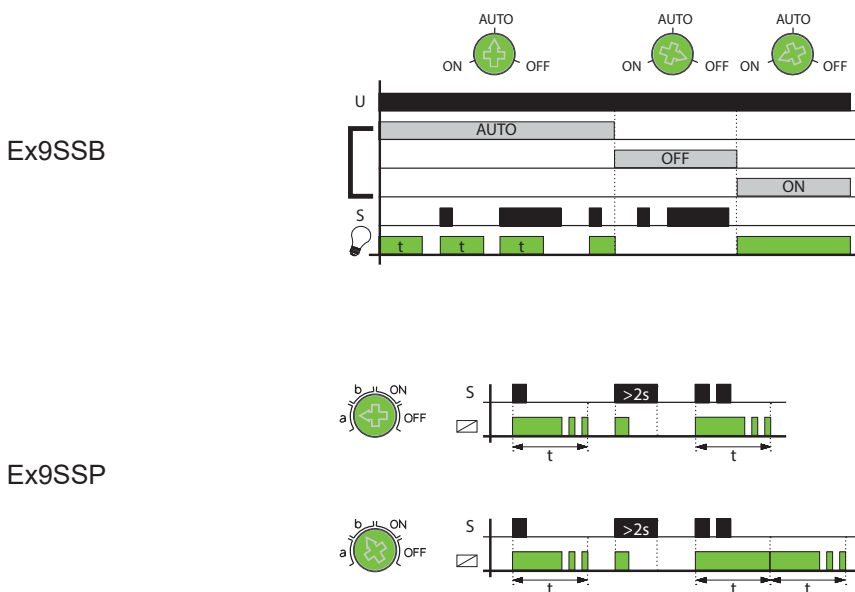

Technical Data Ex9LAS

Modular Light Intensity Analog Switches

General parameters

For light switching according to actual light intensity
Two light adjustment ranges LUX1 (1 - 100 lx) and LUX2 (100 - 50 000 lx), TEST for permanent change of contact
Adjustable time delay (0 - 2 min) to eliminate short term fluctuation in illumination
LED indication on front of the device
Brightness sensor for surface-mounting in the scope of delivery

Electrical parameters

Tested according to	EN 60255-6, EN 61010-1
Rated operating voltage U_e	230 V AC
Operating voltage tolerance	200 — 253 V AC
Rated frequency f	50/60 Hz
Rated current I_e	
AC-1, $\cos \varphi 1$	16 A
Power input (apparent / loss)	max. 3 VA / 1.6 W
Power consumption	≤ 4 W
Channels	1
Switch contact	CO (change-over)
Switching capacity (AC1 / DC)	4000 VA / 384 W
Switching voltage (AC1 / DC)	250 V / 24 V
Inrush current	30 A / < 3 s
Dielectric strength (supply - output)	4 kV
Light adjustment range (LUX1 / LUX2)	1 — 100 lx / 100 — 50000 lx
Switching delay	0 — 2 min
Switching delay setting	potentiometer
Maximum length of connecting cables for sensor	50 m
Brightness sensor	external (in the scope of delivery)
Electrical life (AC1)	100 000 operation cycles
Control power input	0.8 — 530 mVA
Load between S-A2	possible
Impulse length	min. 25 ms
Reset time	150 ms

Technical Data Ex9LAS

Modular Light Intensity Analog Switches

Mechanical parameters

Device width	17.6 mm
Device height	90 mm
Frame size	45 mm
Mounting	onto 35 mm device rail (DIN)
Mounting position	any
Degree of protection	
device	IP20
brightness sensor	IP44
Terminals	screw terminals
Terminal capacity	
device	1 — 2.5 mm ²
brightness sensor	0.35 — 2.5 mm ²
Fastening torque of terminals	1.2 Nm
Mechinal life	10 000 000 operation cycles
Ambient temperature	
device	-20°C — +55°C
brightness sensor	-20°C — +55°C
Installation class	II
Pollution degree	2
Overvoltage category	III
Weight	
device	0.063 kg
brightness sensor	0.02 kg

Dimensions

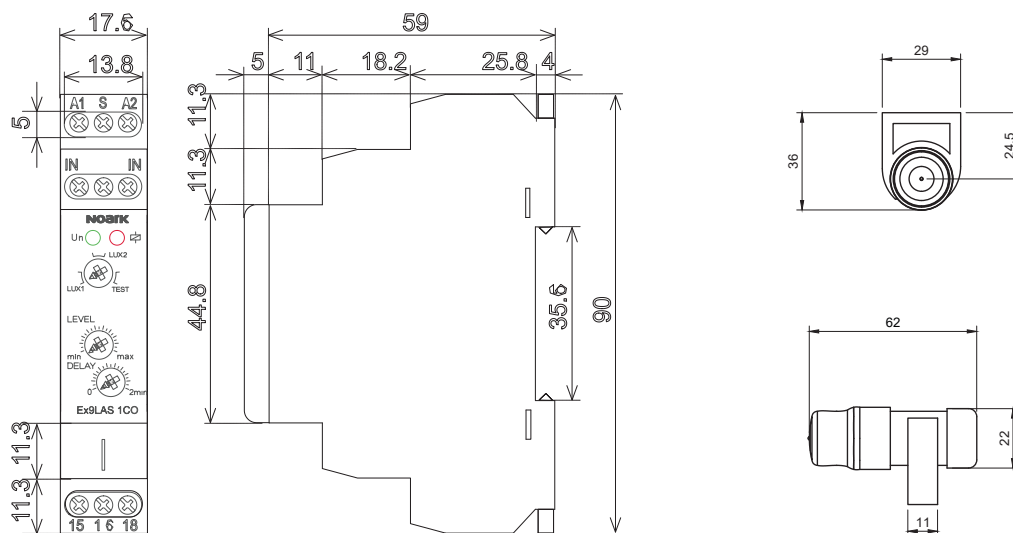

Technical Data Ex9LAS

Modular Light Intensity Analog Switches

Wiring diagrams

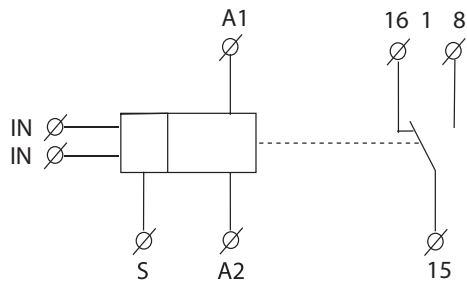

Connections

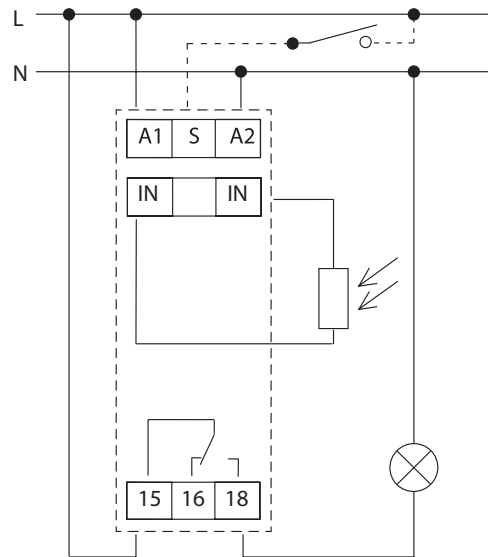

Technical Data Ex9LDS

Modular Light Intensity Digital Switches

General parameters

For switching according to actual day time or light intensity
Modular design
Brightness sensor (IP44) for surface-mounting in the scope of delivery
Automatic summer/winter time change
Random switching function for simulation of presence in a house when nobody is at home
Time clock can override the light sensor for applications when lights are not required
Sealable front cover

Electrical parameters

Tested according to	EN 60730-1, EN 60730-2-7, EN 61812-1, EN 61010-1, EN 60255-6
Rated operating voltage U_e	230 V AC
Operating voltage tolerance	200 — 253 V AC
Rated frequency f	50/60 Hz
Rated current I_e	
AC-1, $\cos \varphi 1$	8 A
Power consumption	≤ 4 VA
Channels	1
Switch contacts	CO (change-over)
Switching voltage (AC / DC)	250 V AC1 / 30 V DC
Switching power (AC1 / DC)	2000 VA / 240 W
Dielectric strength (supply - output)	4 kV
Display type	LCD with backlight
Back-up supply	yes, CR2032 (3V)
Data stored for	min. 10 years
Photoelectric switch	
adjustment range	10 — 50 000 lx
Time switch	
memory	100 spaces
shortest switching time	1 min.
programmable	every 1 min.
block formation	daily, weekly, yearly
switching state display	yes
summer/winter time	automatic change
functions	automatic / manual / random
accuracy	± 1 sec. / day at $+23^\circ\text{C}$
running reserve	3 years
Brightness sensor	external (in the scope of delivery)
Electrical life (AC1)	100 000 operation cycles

Technical Data Ex9LDS

Modular Light Intensity Digital Switches

Mechanical parameters

Device width	36.4 mm
Device height	90 mm
Frame size	45 mm
Mounting	onto 35 mm device rail (DIN)
Mounting position	any
Degree of protection	
device	IP20
brightness sensor	IP44
Terminals	screw terminals
Terminal capacity	
device	1 — 2.5 mm ²
brightness sensor	min. 0.35 mm ²
Fastening torque of terminals	1.2 Nm
Mechinal life	10 000 000 operation cycles
Ambient temperature	
device	-10°C — +55°C
brightness sensor	-20°C — +55°C
Installation class	II
Pollution degree	2
Overvoltage category	III
Weight	
device	0.134 kg
brightness sensor	0.02 kg

Dimensions

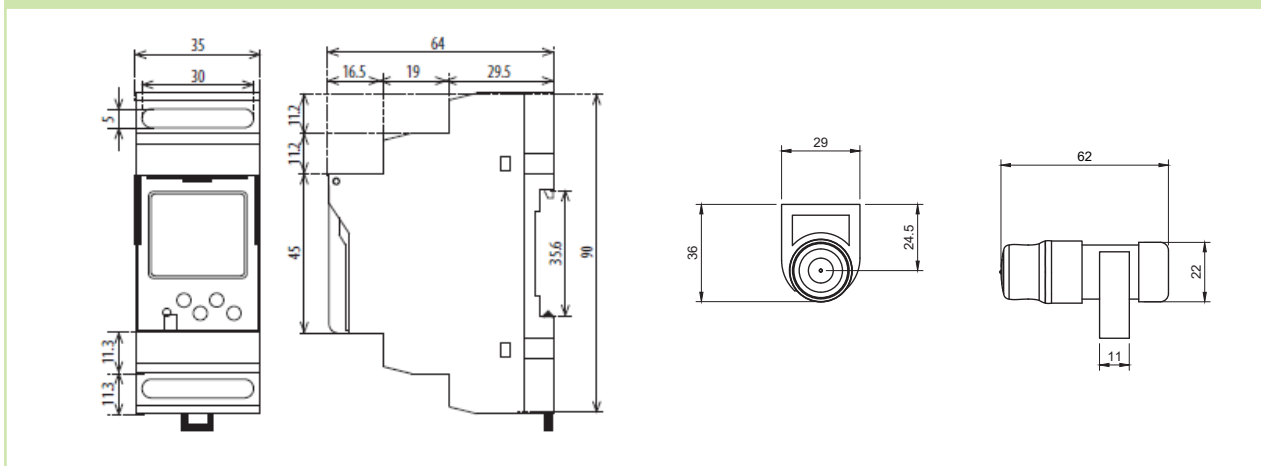

Wiring diagram

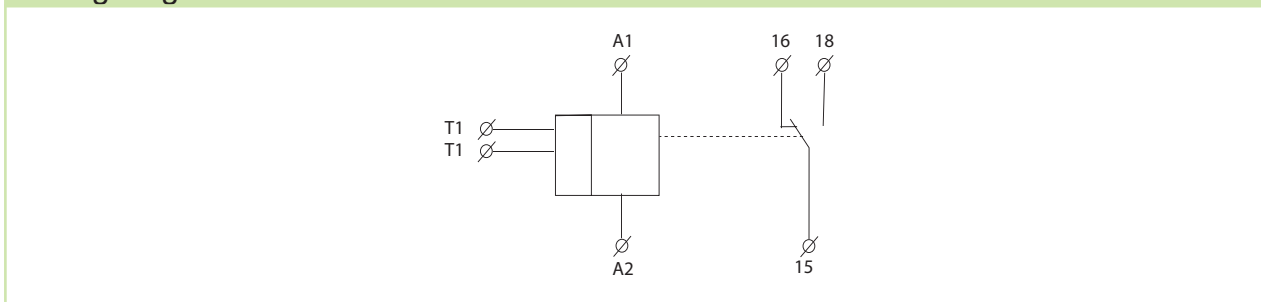

Technical Data Ex9LDS

Modular Light Intensity Digital Switches

Connections

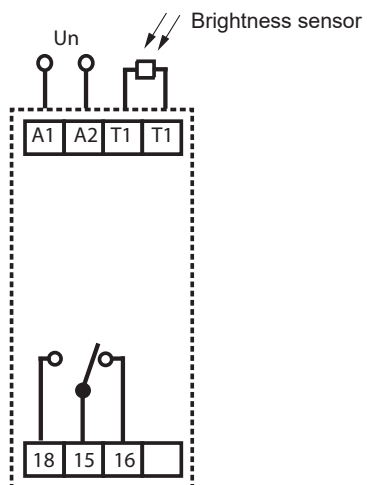

Technical Data Ex9TR DO / IO / F

Single-function time relay

General parameters

Adjustable time range from 0.1 s to 100 hours
Types of relay: DO Delay ON, IC Interval ON, F flasher
Manual time interval and fine time control switches on the front
The relays are initiated by the supply voltage, ie it performs 1 cycle when the voltage is applied
Control input „S“ to pause timing

Electrical parameters

	Ex9TR DO 1CO	Ex9TR IO 1CO	Ex9TR F 1CO
Functions	Delay ON	Interval ON	Flasher
Tested according to	EN 61812-1		
Rated operating voltage U_e	12 - 240 V AC/DC		
Operating voltage tolerance	- 15 %; +10 %		
Rated frequency f	50/60 Hz		
Rated current I_e	16 A / AC1		
Max. power input	2 VA / 1.5 W		
Power consumption	≤ 1.2 W		
Supply indication	green LED		
Switch contact	1x change-over, 16 A		
Adjustment range	0.1 s — 100 h		
Time setting	control switch and potentiometer		
Time deviation	5 % - mechanical setting		
Repeat accuracy	0.2 % - set value stability		
Switching power	4000 VA / AC1, 384 W / DC		
Switching voltage	250 V AC1 / 24 V DC		
Output indication	red LED		
Electrical life (AC1)	50 000 operation cycles		
Max. control power input	4.5 VA / 0.3 W		
Impulse length	min. 25 ms / max. unlimited		
Reset time	max. 150 ms		

Mechanical parameters

Device width	17.6 mm
Device height	90 mm
Frame size	45 mm
Mounting	onto 35 mm device rail (DIN)
Mounting position	any
Degree of protection	IP20
Terminals	screw terminals
Terminal capacity	1 — 2.5 mm ²
Fastening torque of terminals	0.8 Nm
Mechanical life	10 000 000 operation cycles
Ambient temperature	-20°C — +55°C
Overvoltage category	III
Installation class	II
Pollution degree	2
Weight	0.061 kg

Technical Data Ex9TR DO / IO / F

Single-function time relay

Dimensions

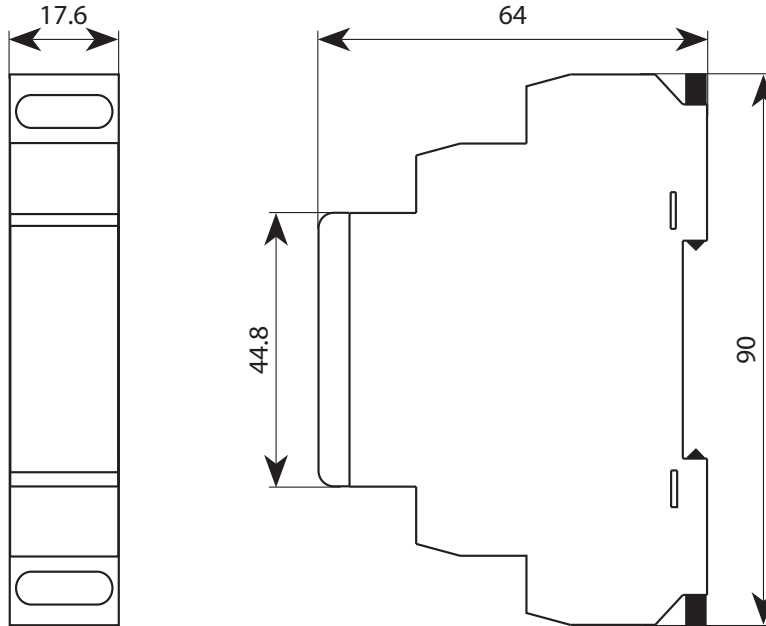

Wiring diagrams

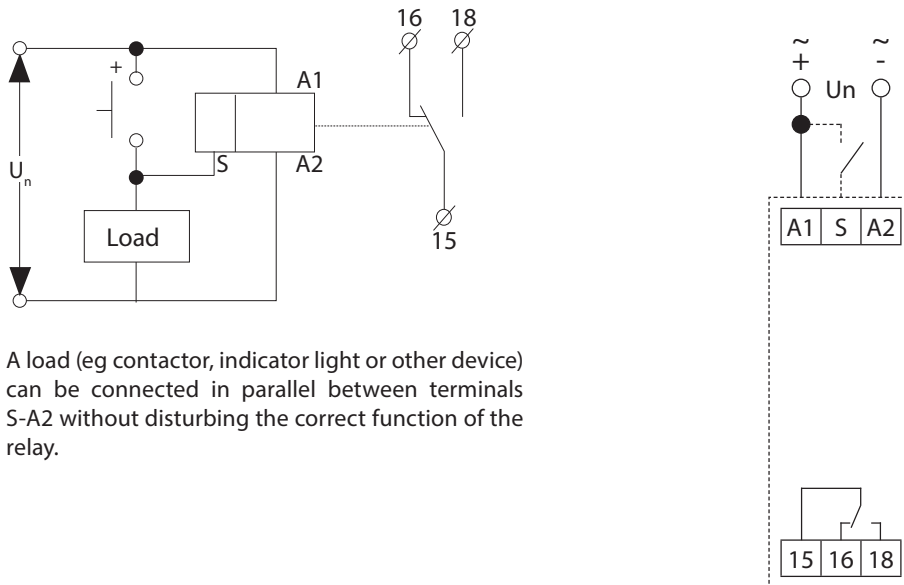

A load (eg contactor, indicator light or other device) can be connected in parallel between terminals S-A2 without disturbing the correct function of the relay.

Technical Data Ex9TR DO / IO / F

Single-function time relay

Functions

Ex9TR DO 1CO - Delay ON

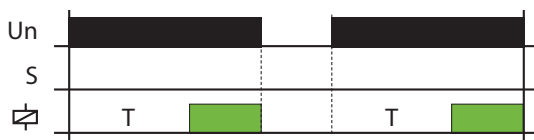

When the supply voltage is applied, the time delay T begins. At the end of the timing, the relay closes and this state lasts until the supply voltage is disconnected.

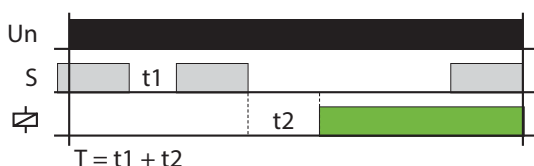

If the control contact is closed and then the supply voltage is connected, the relay is open and the timing does not start until the control contact is opened. When the timing is over, the relay closes. If the control contact is closed during timing, the timing is interrupted and does not resume until the control contact is opened.

Ex9TR IO 1CO - Interval ON

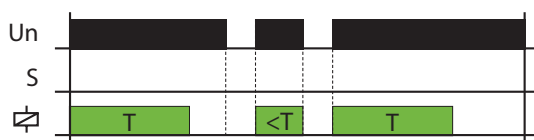

When the supply voltage is applied, the relay closes and the time delay T begins. At the end of the timing, the relay opens and this state lasts until the supply voltage is disconnected.

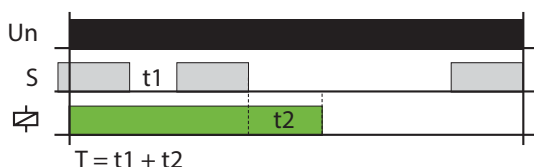

If the control contact is closed and then the supply voltage is connected, the relay closes and the timing does not start until the control contact is opened. After completion of the relay timing, the relay opens. If the control contact is closed during timing, the timing is interrupted and does not resume until the control contact is opened.

Ex9TR F 1CO - Flasher

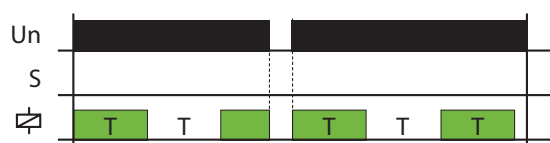

When the supply voltage is applied, the relay closes and the time delay T begins. At the end of the timing, the relay opens and the time delay T runs again. After the end of the timing, the relay closes again and the sequence is repeated until the supply voltage is disconnected.

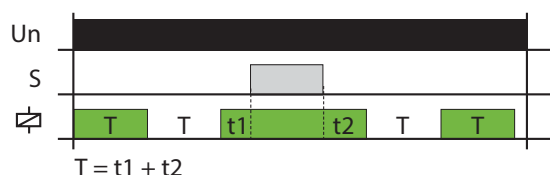

If the control contact is closed during timing, the timing is interrupted and does not resume until the control contact is opened.

Note: The relays are initiated by the supply voltage, i.e. it performs 1 cycle when the voltage is applied.

Technical Data Ex9TR 10M

Multifunction time relay

General parameters

Time adjustment range from 0.1 s to 10 days
Version with 1 changeover contact or with 3 changeover contacts
10 adjustable time functions
5 functions controlled by input voltage and 5 functions controlled by control contact
Manual control switches for time interval, fine time setting and function selection on the front

Electrical parameters

	Ex9TR 10M 1CO	Ex9TR 10M 3CO	
Functions	10 adjustable functions		
Tested according to	EN 61812-1		
Rated operating voltage U_e	12 - 240 V AC/DC		
Operating voltage tolerance	- 15 %; +10 %		
Rated frequency f	50/60 Hz		
Rated current I_e	16 A / AC1		
Max. power input	2 VA / 1.5 W		
Power consumption	≤ 1.2 W	≤ 2.4 W	
Supply indication	green LED		
Switch contact	1x change-over contact , 16 A	1x change-over contact, 16 A	2x change-over contact 8 A
Adjustment range	4000 VA / AC1, 384 W / DC	4000 VA / AC1, 384 W / DC	2000 VA / AC1, 192 W / DC
Time setting	control switch and potentiometer		
Time deviation	5 % - mechanical setting		
Repeat accuracy	0.2 % - set value stability		
Switching power	0.1 s — 10 days		
Switching voltage	250 V AC1 / 24 V DC		
Output indication	red LED		
Electrical life (AC1)	50 000 operation cycles	50 000 cycles	10 000 cycles
Max. control power input	4.5 VA / 0.3 W		
Impulse length	min. 25 ms / max. unlimited		
Reset time	max. 150 ms		

Mechanical parameters

Device width	17.6 mm
Device height	90 mm
Frame size	45 mm
Mounting	onto 35 mm device rail (DIN)
Mounting position	any
Degree of protection	IP20
Terminals	screw terminals
Terminal capacity	1 — 2.5 mm ²
Fastening torque of terminals	0.8 Nm
Mechanical life	10 000 000 operation cycles
Ambient temperature	-20°C — +55°C
Overvoltage category	III
Installation class	II
Pollution degree	2
Weight	0.062 kg

Technical Data Ex9TR 10M

Multifunction time relay

Dimensions

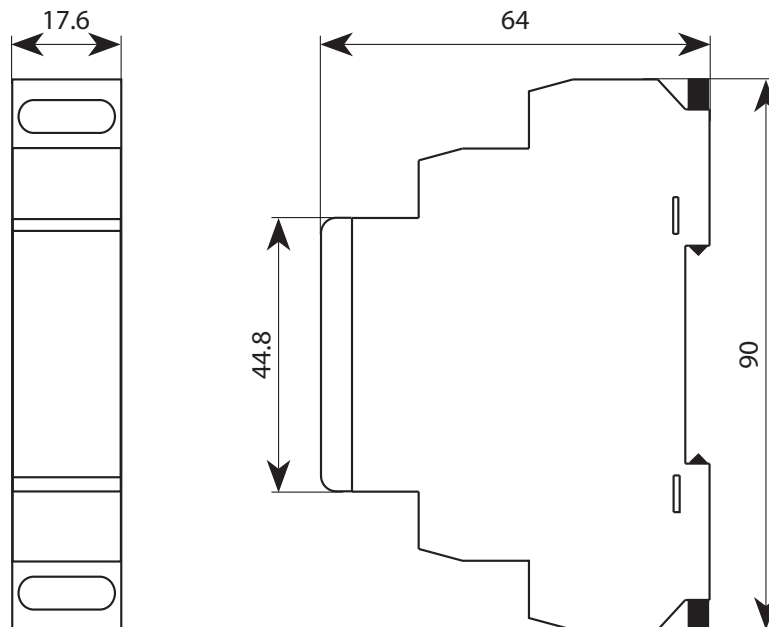

Wiring diagram

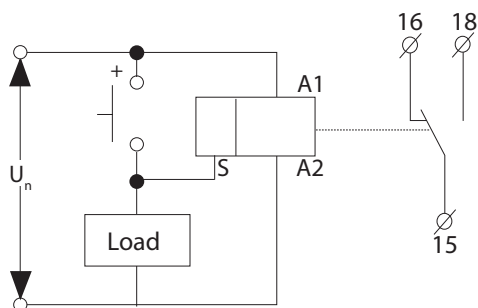

A load (eg contactor, indicator light or other device) can be connected in parallel between terminals S-A2 without disturbing the correct function of the relay.

Ex9TR 10M 1CO

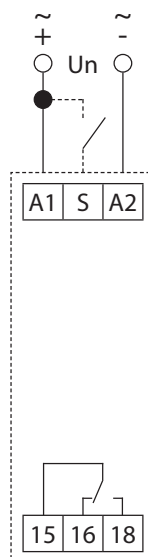

Ex9TR 10M 3CO

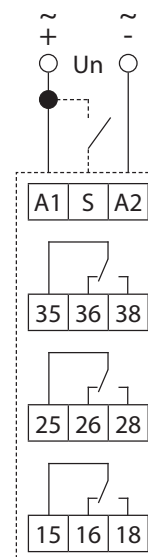

Potential difference between supply terminals (A1-A2), output contact 2 (25-26-28) and output contact 3 (35-36-38) must not exceed 250 V AC rms / DC.

Technical Data Ex9TR 10M

Multifunction time relay

Functions

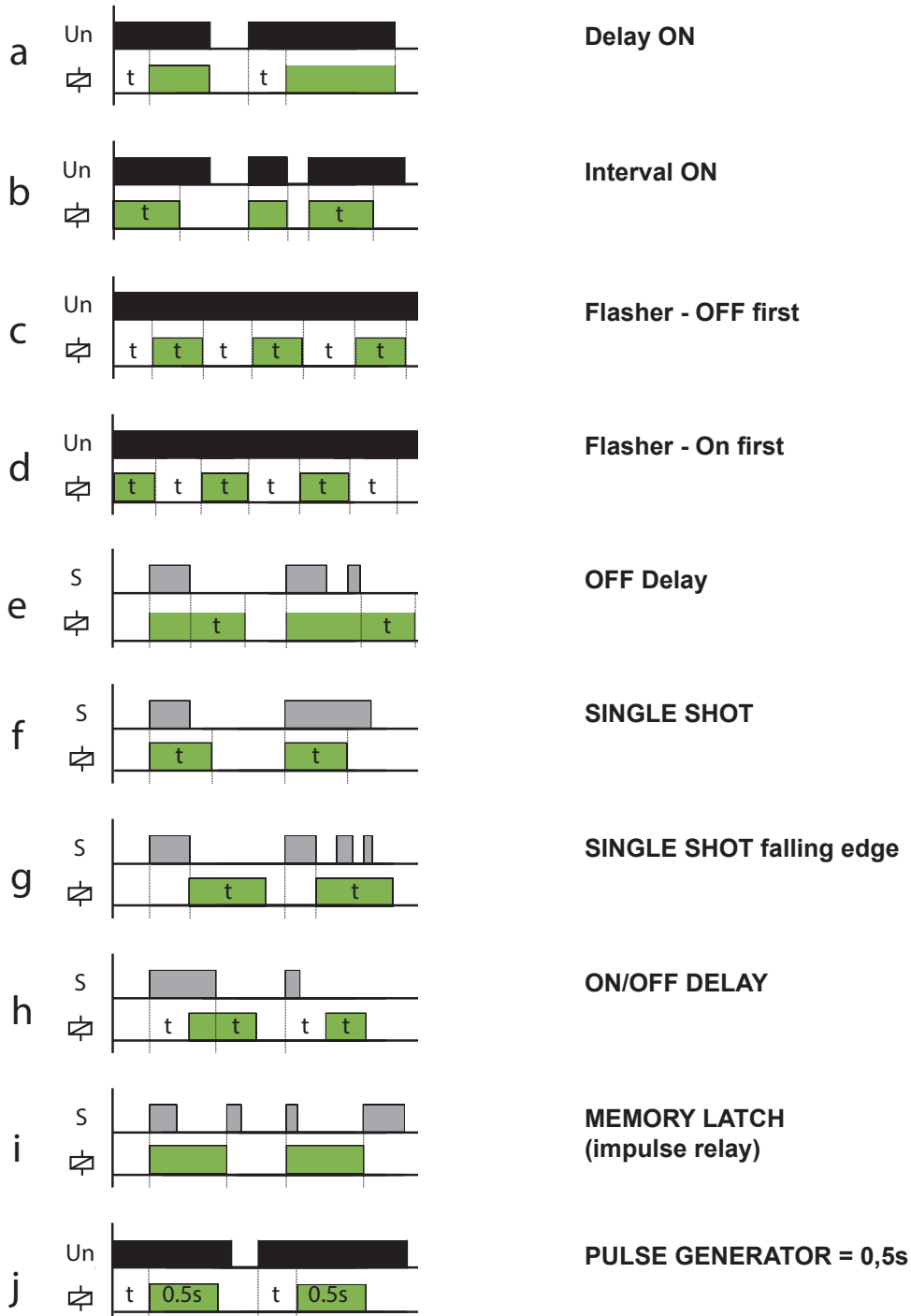

Technical Data Ex9TR C

Asymmetric cycler

General parameters

Adjustable time range from 0.1 s to 100 days
Possibility to set PULSE and GAP time
Manual time interval and fine time control switches on the front
Cycler starting with pulse or starting with gap with connected terminal „S“

Electrical parameters

	Ex9TR C 1CO
Functions	Asymmetric cycler
Tested according to	EN 61812-1
Rated operating voltage U_e	12 - 240 V AC/DC
Operating voltage tolerance	-1.5 %; +10 %
Rated frequency f	50/60 Hz
Rated current I_e	16 A / AC1
Max. power input	2 VA / 1.5 W
Power consumption	≤ 1.2 W
Supply indication	green LED
Switch contact	1x change-over contact, 16 A
Adjustment range	0.1 s — 100 days
Time setting	control switch and potentiometer
Time deviation	5 % - mechanical setting
Repeat accuracy	0.2 % - set value stability
Switching power	4000 VA / AC1, 384 W / DC
Switching voltage	250 V AC1 / 24 V DC
Output indication	red LED
Electrical life (AC1)	50 000 operation cycles
Max. control power input	4.5 VA / 0.3 W
Reset time	max. 150 ms

Mechanical parameters

Device width	17.6 mm
Device height	90 mm
Frame size	45 mm
Mounting	onto 35 mm device rail (DIN)
Mounting position	any
Degree of protection	IP20
Terminals	screw terminals
Terminal capacity	1 — 2.5 mm ²
Fastening torque of terminals	0.8 Nm
Mechanical life	10 000 000 operation cycles
Ambient temperature	-20°C — +55°C
Overvoltage category	III
Installation class	II
Pollution degree	2
Weight	0.061 kg

Technical Data Ex9TR C

Asymmetric cycler

Dimensions

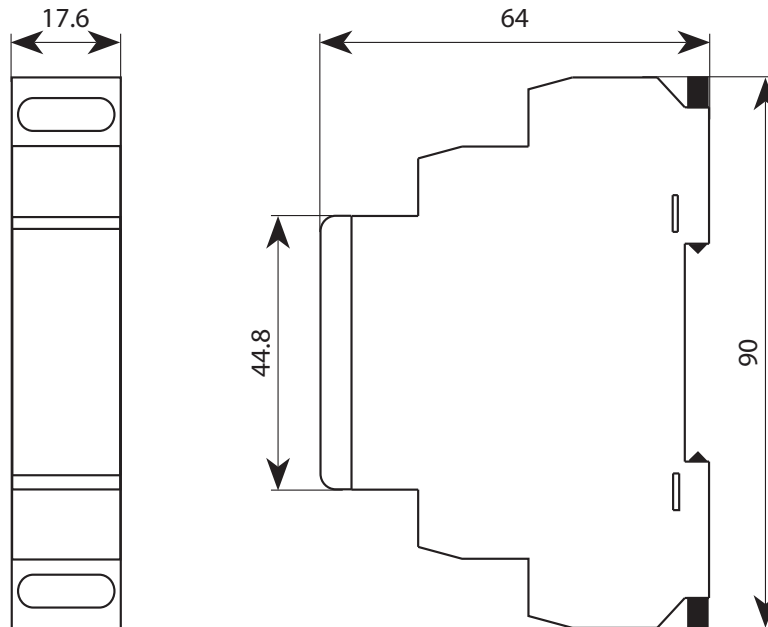

Wiring diagrams

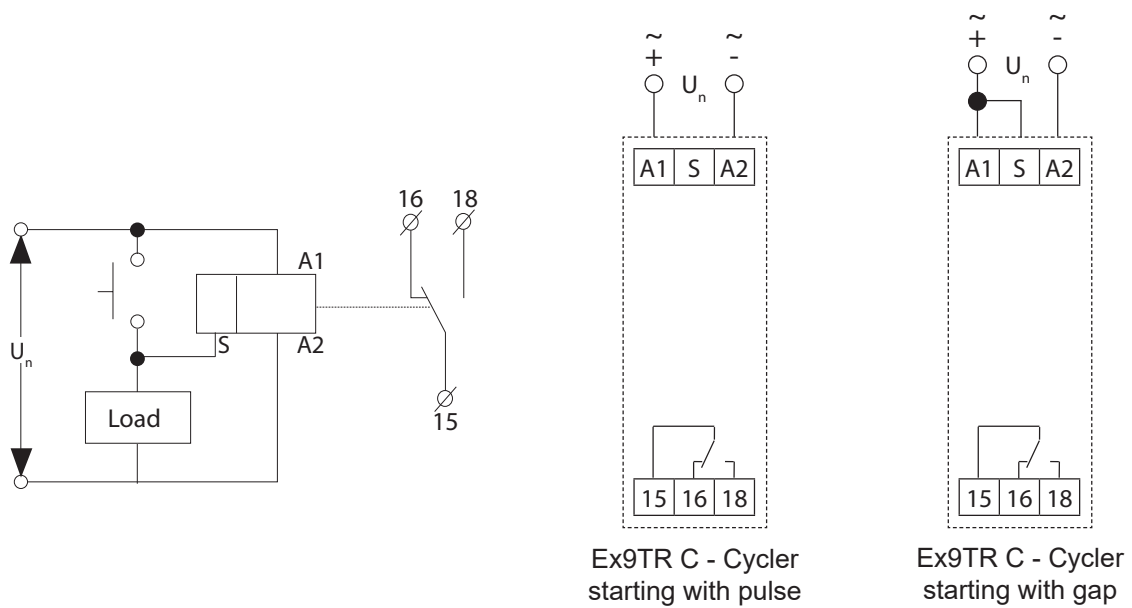

Technical Data Ex9TR C

Asymmetric cycler

Functions

Ex9TR C - Cyclor starting with pulse

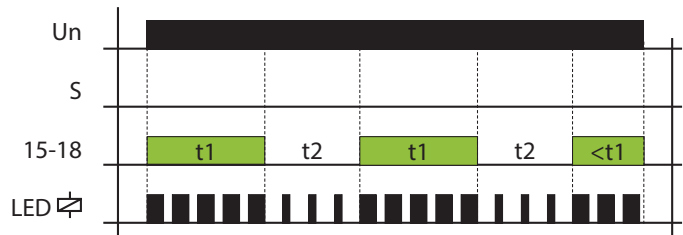
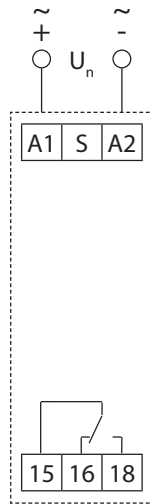

Ex9TR C - Cyclor starting with gap

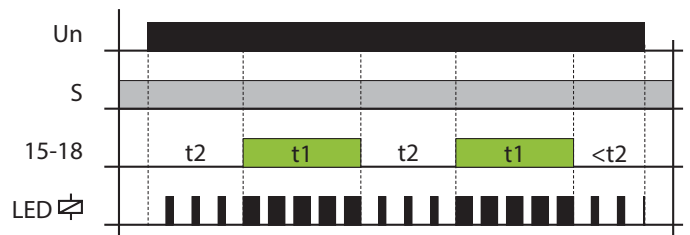

Technical Data Ex9TR S-D

Delay started Star/Delta

General parameters

Adjustable time range from 0.1 s to 100 hours in star connection
Adjustable time delay from 0.1 - 1 s
Manual time interval and fine time control switches on the front

Electrical parameters

Ex9TR S-D 2CO	
Delay starter Star/Delta	
Functions	EN 61812-1
Tested according to	EN 61812-1
Rated operating voltage U_e	12 - 240 V AC/DC
Operating voltage tolerance	- 15 %; +10 %
Rated frequency f	50/60 Hz
Rated current I_e	16 A / AC1
Max. power input	2 VA / 1.5 W
Power consumption	≤ 1.2 W
Supply indication	green LED
Switch contact	2x change-over contact, 16 A
Adjustment range	t1 = 0.1 s — 100 h t2 = 0.1 — 1s
Time setting	control switch and potentiometer
Time deviation	5 % - mechanical setting
Repeat accuracy	0.2 % - set value stability
Switching power	4000 VA / AC1, 384 W / DC
Switching voltage	250 V AC1 / 24 V DC
Output indication	red LED
Electrical life (AC1)	50 000 operation cycles
Reset time	max. 150 ms

Mechanical parameters

Device width	17.6 mm
Device height	90 mm
Frame size	45 mm
Mounting	onto 35 mm device rail (DIN)
Mounting position	any
Degree of protection	IP20
Terminals	screw terminals
Terminal capacity	1 — 2.5 mm ²
Fastening torque of terminals	0.8 Nm
Mechanical life	10 000 000 operation cycles
Ambient temperature	-20°C — +55°C
Overvoltage category	III
Installation class	II
Pollution degree	2
Weight	0.078 kg

Technical Data Ex9TR S-D

Delay starter Star/Delta

Dimensions

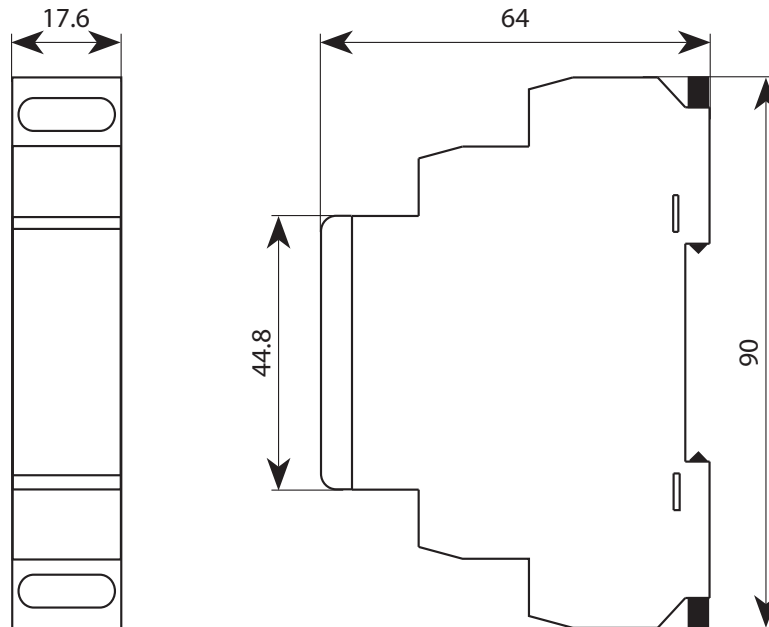

Wiring diagrams

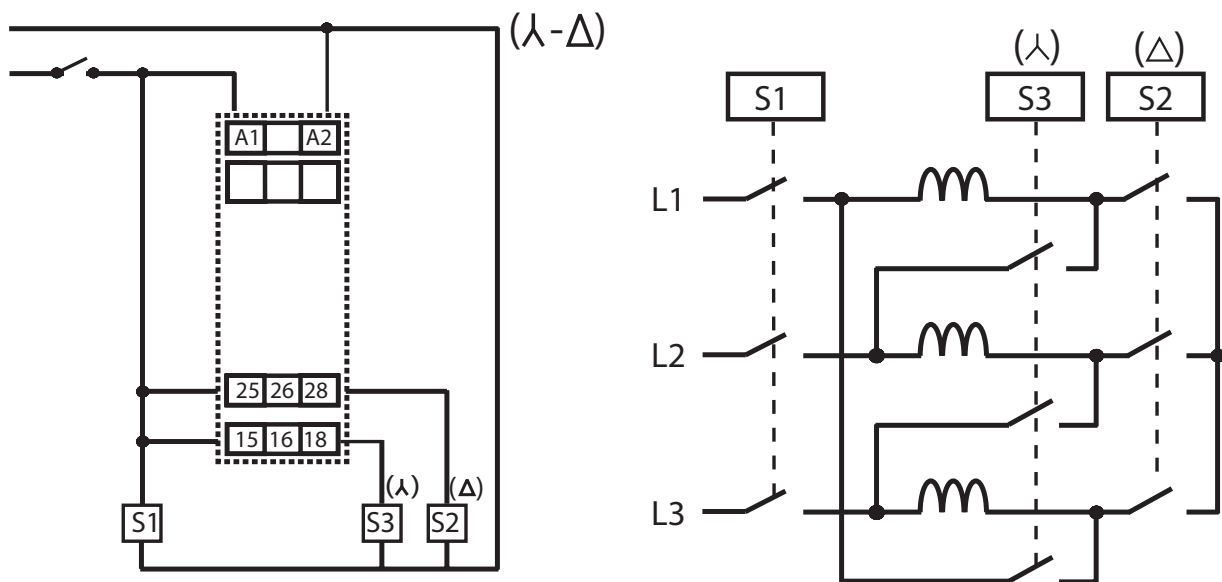

Technical Data Ex9TR S-D

Delay starter Star/Delta

Symbol

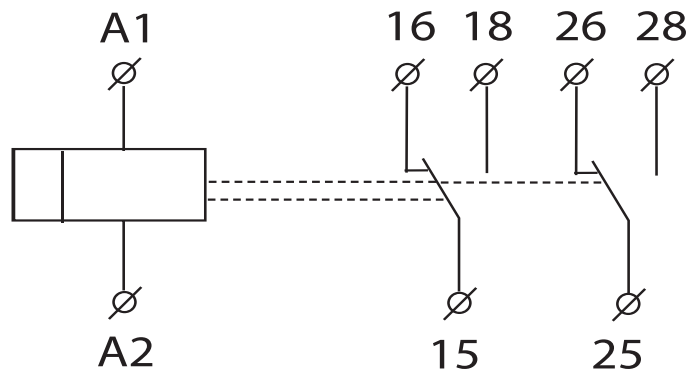

Functions

Ex9TR S-D Delay starter Star/Delta

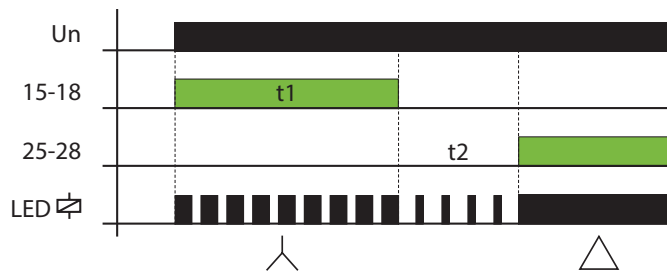

Technical Data Ex9HB

DIN Rail Bell

General parameters

Suitable mainly for household applications.

1-module width

Rated operating voltage are 12 V and 230 V AC.

It is recommended to remove dust from the device daily.

Electrical parameters

Tested according to	IEC/EN 60947-5
Rated op. voltage U_e	12V or 230 V AC
Rated frequency	50 Hz
Rated impulse withstand voltage U_{imp}	4 kV
Rated insulation voltage U_i	230 V
Sound level	≥ 75 dB
Max. continuous ringing	< 1 min

Mechanical parameters

Device width	18 mm
Device height	83.8 mm
Frame size	45 mm
Mounting	easy fastening onto 35 mm device rail (DIN)
Degree of protection	IP20
Terminals	lift
Terminal capacity	1.5 — 6 mm ²
Fastening torque of terminals	0.5 Nm
Ambient temperature	-5 — +40 °C
Altitude	≤ 2000 m
Relative humidity	≤ 95 %
Pollution degree	3
Installation class	III
Weight	0.072 kg / 0.069 kg

Technical Data Ex9HB

DIN Rail Bell

Dimensions

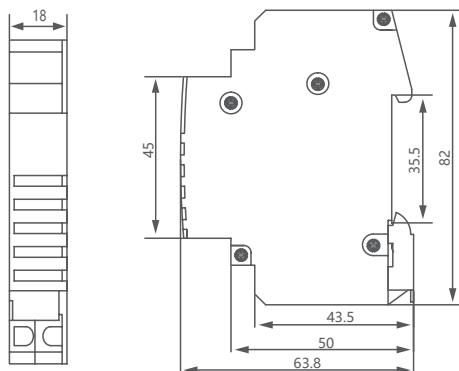

Wiring diagrams



Technical Data Ex9PS

Power supplies

General parameters

Thermal protection - in case of thermal overload the source switches off, after cooling it switches on again

The output current is limited by an electronic fuse, when the maximum current is exceeded, the source switches off, after a short delay it switches on again

Stabilized output voltage

Electrical parameters

	Ex9PS 10W S 24VDC	Ex9PS 30W S 24VDC	Ex9PS 30W S R	Ex9PS 100W S 12VDC	Ex9PS 100W S 24VDC
Tested according to	EN 61204-1, EN 61204-3, EN 61204-7				
Rated operating voltage U	184 - 250 V AC	100 - 250 V AC			
Burden without load (max.)	5 VA / 2 W	10 VA / 1.5 W	10 VA / 1.7 W	12 VA / 2 W	
Burden with full load (max.)	25 VA / 13 W	70 VA / 37 W		195 VA / 121 W	
Protection	fuse T1A	fuse T2A		fuse T 3.15A	
Output					
Output voltage DC Max. current	12.2 V 0.84 A	24.2 V 1.25 A	12.2 V / 24.2 V 2.5A / 1.25 A	12.2 V 8.4 A	24.2 V 4.2 A
Tolerance of output voltage	± 2%		± 3%	± 2%	
Electrical strength input- output	4kV				
Output indication	green LED				
Wave of off-load output voltage	80 mV	30 mV	40 mV	1 V	
Wave of output voltage with max load	20 mV	80 mV	500 mV	40 mV	
Time delay after connection	max. 1s	max. 5s	max. 1s	max. 3s	
Time delay after over-load	max. 1s			max. 0.5s	
Efficiency	> 75%	> 82%	> 81%	> 82%	
Electronic fuse	electronic protections short-circuit, over load, over voltage (from 120% of rated output)				

Mechanical parameters

Device width	17.6 mm	52 mm		105 mm	
Device height	90 mm				
Frame size	45 mm				
Mounting	onto 35 mm device rail (DIN)				
Degree of protection	front protection IP40 / terminals IP20				
Terminals	screw terminals				
Terminal capacity	1 — 2.5 mm ²				
Fastening torque of terminals	0.8 Nm				
Ambient temperature	-20°C — +40°C				
Overvoltage category	II				
Pollution degree	2				
Weight	0.065 kg	0.160 kg	0.163 kg	0.377 kg	

Technical Data Ex9PS

Power supplies

Dimensions

Ex9PS 10W S 24V DC

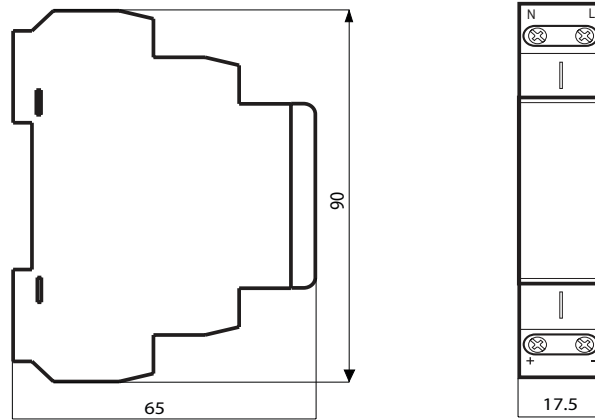

**Ex9PS 30W S R
Ex9PS 100W S 24V DC**

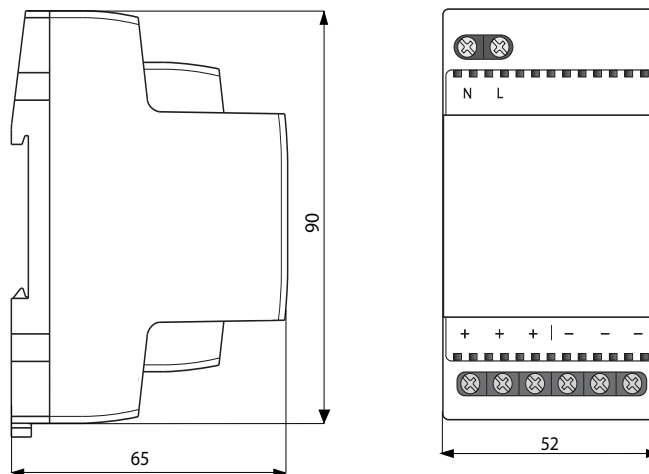

**Ex9PS 100W S 12V DC
Ex9PS 100W S 24V DC**

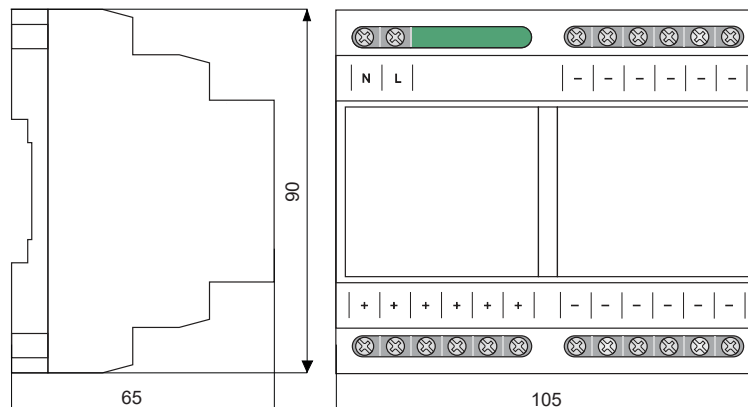

Technical Data Ex9PS

Power supplies

Wiring diagram

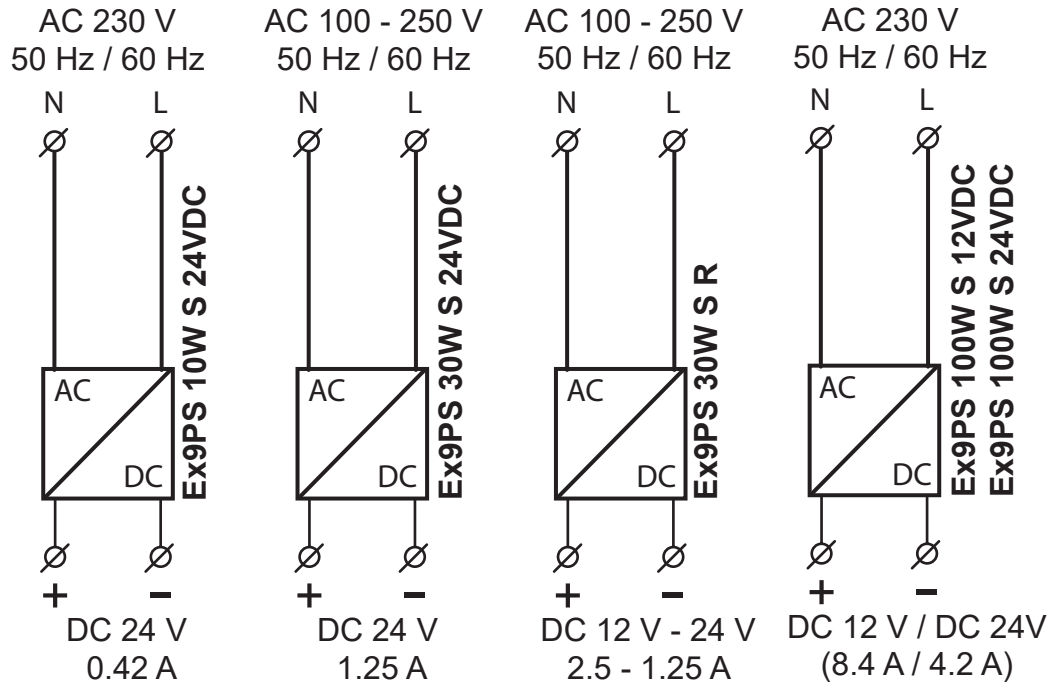

Technical Data Ex9PS

Power supplies with built-in transformer for AC output

General parameters

Power supplies with built-in transformer for AC output
Integrated short circuit protection

Electrical parameters

	Ex9PS 8W S R T	Ex9PS 8W N 24V AC/DC T
Tested according to	EN 61204-1, EN 61204-3, EN 61204-7	
Rated operating voltage U	230 V AC	
Supply voltage tolerance	-15 %; +10 %	
Consumption without load (max)	9 VA / 2.5 W	9 VA / 2 W
Consumption with load (max)	11.5 VA / 8 W	
Protection	primary wind T100 mA	
Output		
Output voltage	5-24 V DC stab. 24 V DC nonstab. 24 V AC	24V DC nonstab. 24 V AC
Tolerance output voltage	±5 %	x
Dielectrical strenght (prim/sec)	4 kV	
Wave of output voltage	300 mV	max. 3 V
Output voltage-no load AC	32 V	
Output voltage-no load DC	44 V	
Effi ciency	75 %	x
Electronic fuse	Towards black-out and current overloading	x

Mechanical parameters

Device width	52 mm	
Device height	90 mm	
Frame size	45 mm	
Mounting	onto 35 mm device rail (DIN)	
Degree of protection	front protection IP40 / terminals IP20	
Terminals	screw terminals	
Terminal capacity	1 — 2,5 mm ²	
Fastening torque of terminals	0.8 Nm	
Ambient temperature	-20°C — +40°C	
Overvoltage category	II	
Pollution degree	2	
Weight	0.398 kg	0.368 kg

Technical Data Ex9PS

Power supplies with built-in transformer for AC output

Dimensions

Ex9PS 8W S R T
Ex9PS 8W N 24V AC/DC T

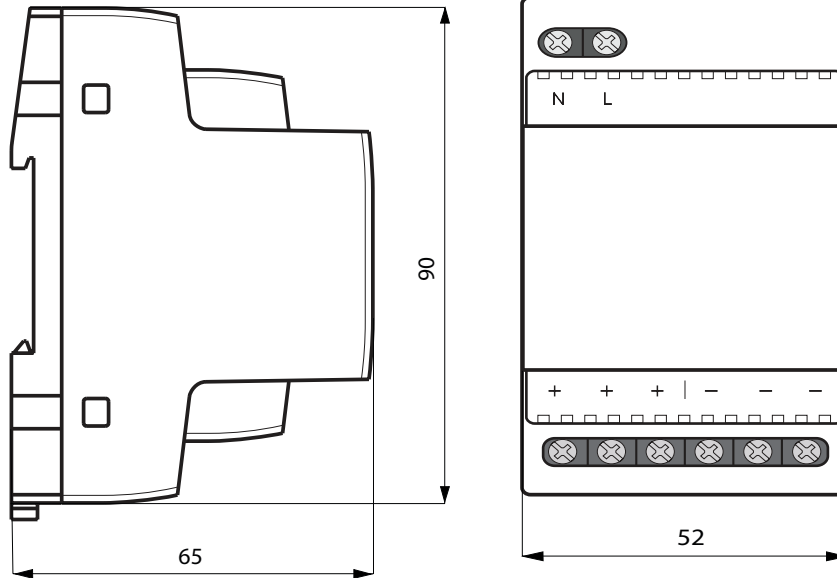

Wiring diagram

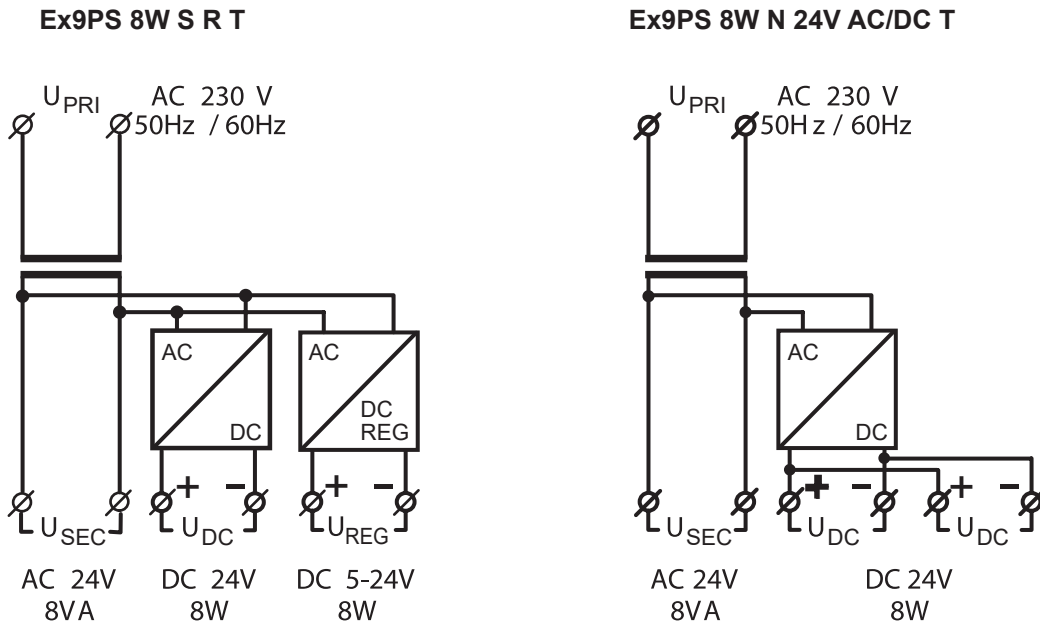

Index

Type	Ordering info	Technical data	Type	Ordering info	Technical data
AL31	132	278	Ex9LE	109	261
ASNA	136	287	Ex9L-H	66	236
ASNB	136	286	Ex9L-N	74	239
ASNE	137	291	Ex9NLE	101	255
ASNF	136	288	Ex9NL-N	105	258
ASNT	137	289	Ex9PD1	174	323
ASNUV	137	290	Ex9PD1e	178	325
AX31	132	278	Ex9PD2	175	323
AXC31	140	292	Ex9PD2e	178	325
AXL31	132	278	Ex9PD3e	178	325
AXLC31	140	292	Ex9PS	200	357
CT	122	271	Ex9PN	37	218
Ex9B125	29	214	Ex9SN25B	127	274
Ex9B40J	25	212	Ex9SS	188	334
Ex9BH	9	204	Ex9TR	192	343
Ex9BI	61	234	Ex9TAM2	182	327
Ex9BL-H	89	249	Ex9TDM	184	329
Ex9BL-N	95	252	Ex9UE1+2, 12.5 kA	146	301
Ex9BN	17	208	Ex9UE1+2, 25 kA	144	298
Ex9BP-JX	41	221	Ex9UE2	148	307
Ex9BT	172	321	Ex9UE3	150	310
Ex9CL-100	82	242	LK-I	132	
Ex9DTS	186	331	OVT31	133	284
Ex9EM	116	263	SHT31	132	280
Ex9EMS	118	266	SHTC31	140	294
Ex9F	48	224	UVT31	133	282
Ex9FP	50	226	UVTC31	140	296
Ex9FS	52	228			
Ex9HB	198	355			
Ex9CH20	154	312			
Ex9CH25	156	314			
Ex9CH40	157	314			
Ex9CH63	158	314			
Ex9CH16M	160	316			
Ex9CH20M	161	316			
Ex9CH25M	162	316			
Ex9CH32M	163	316			
Ex9CH40M	164	316			
Ex9CH63M	165	316			
Ex9I125	56	230			
Ex9I40	58	232			
Ex9JU	168	319			
Ex9LAS	190	337			
Ex9LB63	86	246			
Ex9LDS	190	340			

Notes

A large grid of dashed lines for taking notes, covering most of the page below the header and above the footer.

Catalogues and assortment overview



INSTALLATION DEVICES

- Miniature Circuit Breakers
- Fuse Holders and Disconnectors
- Isolators
- Residual Current Devices
- Energy Meters
- Motor Protective Circuit Breakers
- Accessories for Installation Devices
- Surge Protection Device
- Installation Relays and Contactors
- Switches and Signal Lamps
- Timers and Light Intensity Switches
- Other Installation Devices



MOULDED CASE CIRCUIT BREAKERS

- AC Thermomagnetic Moulded Case Circuit Breakers Ex9M
- AC Electronic Moulded Case Circuit Breakers Ex9M SU20L (DIP switches version)
- AC Electronic Moulded Case Circuit Breakers Ex9M SU20S (LCD version)
- AC MCCB Switch Disconnectors Ex9MSD
- DC Thermomagnetic Moulded Case Circuit Breakers Ex9M
- DC MCCB Switch Disconnectors Ex9MSD
- Accessories for MCCBs



INDUSTRIAL DEVICES

- Contactors and Relays
- Motor Protective Circuit Breakers
- Overload Relays
- Accessories
- Panel Mounted Devices

Catalogues and assortment overview

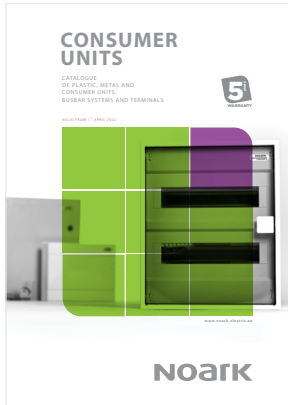

CONSUMER UNITS

- Plastic Consumer Units
- Plastic Consumer Units with Sheet Steel Door
- Plastic Consumer Units for Outdoor Use
- Metal Flat Enclosures
- Metal Enclosures with Mounting Plates
- Interconnection Systems



PHOTOVOLTAIC COMPONENTS AND SOLUTIONS

- DC Circuit breakers
- DC Fuse holders
- DC Switch disconnectors
- RCCBs
- Energy meters
- DC SPDs
- PV outdoor enclosures
- EV chargers



AIR CIRCUIT BREAKERS

- Digital Tripping Units
- Air Circuit Breakers
- Air Switch Disconnectors
- Accessories

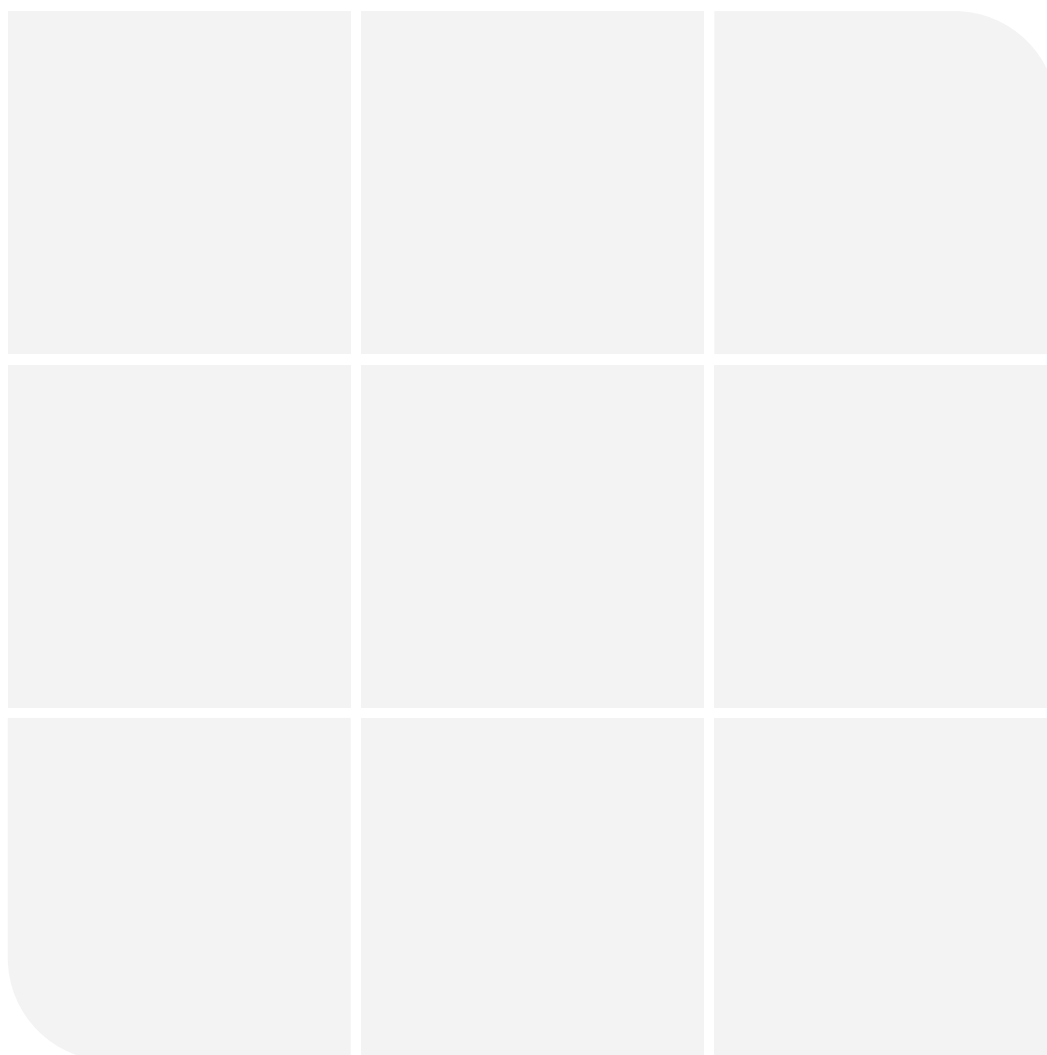

NOARK Electric Europe s.r.o.

Sezemická 2757/2, 193 00 Prague 9, Czech Republic

Phone: +420 226 203 120

E-mail: Europe@noark-electric.com

www.noark-electric.eu

NOARK

